

**NOT MEASUREMENT
SENSITIVE**

**MIL-HDBK-470A
4 AUGUST 1997
SUPERSEDING
MIL-HDBK-470
12 JUNE 1995
MIL-HDBK-471
12 JUNE 1995**

DEPARTMENT OF DEFENSE HANDBOOK

DESIGNING AND DEVELOPING MAINTAINABLE PRODUCTS AND SYSTEMS

VOLUME I



This handbook is for guidance only. Do not cite this document as a requirement

AMSC N/A

AREA MNTY

DISTRIBUTION STATEMENT A. Approved for public release; distribution is unlimited.

FOREWORD

1. This handbook is approved for use by all Departments and Agencies of the Department of Defense (DoD). It was developed by the DoD with the assistance of the military departments, federal agencies, and industry and replaces in their entirety Military Handbooks 470 and 471 (both formerly military standards). The handbook provides guidance to maintainability managers and engineers in developing and implementing a sound maintainability program for all types of products.
2. This handbook is for guidance only. This handbook cannot be cited as a requirement. If it is, the contractor does not have to comply.
3. Maintainability is a discipline that has become more importance over the past 30 years as military systems became more complex, support costs increased, and defense budgets decreased. It is also important in the commercial sector, where high levels of maintainability are increasingly becoming an important factor in gaining customer loyalty. In fact, American products that once were shunned in favor of foreign alternatives recently have made or are making a comeback. This shift in consumer preferences has been directly attributed to significant improvements in the quality of the American products, a quality that includes good maintainability.
4. Despite the fact that maintainability has been a recognized discipline for much longer than 30 years, achieving the high levels of maintainability needed in military and complex industrial systems is too often an elusive goal. System complexity, competing performance requirements, the rush to incorporate promising but immature technologies, and the pressures of acquisition budget and schedule contribute to this elusiveness.
5. Noting the significant improvement in the quality of commercial products and the rapidity with which new technology is incorporated in commercial products, and facing a shrinking defense budget, the Department of Defense changed its acquisition policies to foster the evolution of a unified military and commercial industrial base. The objective is to capitalize on the "best practices" that American business has developed or adopted, primarily in response to foreign competitive pressures. When combined with the knowledge and expertise of military contractors in building complex, effective military systems (soundly demonstrated during Desert Storm), these commercial practices will help the Department of Defense to acquire world-class systems on time and within budget.
6. The information in this handbook reflects both the move to incorporate commercial practices and the lessons learned over many years of acquiring weapon systems "by the book." When appropriate, commercial standards are cited herein for reference. Military standards and specifications, which cannot be used as requirements in solicitations without obtaining a waiver, are also cited for guidance. These documents are familiar to both military and commercial companies, contain a wealth of valuable information, and often have no commercial counterpart. Whereas many of these documents emphasize what to do and how to do it, this handbook, in the

spirit of the new policies regarding acquisition, focuses on the objectives of a sound maintainability program and the tools available to meet these objectives.

7. Beneficial comments (recommendations, additions, deletions) and any pertinent data which may be useful in improving this document should be addressed to: Rome Laboratory/ERSR, 525 Brooks Road, Rome, NY 13441-4505. Comments should be submitted using the self-addressed Standardization Document Improvement Proposal (DD Form 1426) appearing at the end of this document or by letter.

PARAGRAPH

PAGE

4.0	ELEMENTS OF A MAINTAINABILITY PROGRAM.....	4-1
4.1	Overview.....	4-1
4.2	Management Approach.....	4-1
4.2.1	Clear Responsibility.....	4-2
4.2.2	Adequate Resources (Quantity and Quality).....	4-2
4.2.3	Lines of Communication.....	4-2
4.2.4	Integration with Related Functions.....	4-2
4.2.5	Subcontractor and Vendor Control.....	4-2
4.2.6	Reviews.....	4-3
4.3	Design for Maintainability.....	4-3
4.3.1	Specific Considerations.....	4-3
4.3.1.1	Support Concept.....	4-4
4.3.1.2	Operational and Support Environment.....	4-6
4.3.1.3	Preventive Versus Corrective Maintenance Requirements.....	4-6
4.3.1.4	Human Engineering (HE).....	4-9
4.3.1.4.1	Presentation of Information.....	4-10
4.3.1.4.2	Controls.....	4-11
4.3.1.4.3	Anthropometrics.....	4-11
4.3.1.5	Maintenance Tools and Support Equipment.....	4-12
4.3.1.6	Maintenance Training.....	4-12
4.3.1.7	Testability and Diagnostics.....	4-12
4.3.1.7.1	Testability Design.....	4-13
4.3.1.7.2	Diagnostic Capability.....	4-16
4.3.1.8	Interfaces and Connections.....	4-17
4.3.1.9	Safety and Induced Failures.....	4-18
4.3.1.10	Standardization and Interchangeability.....	4-18
4.3.1.10.1	Standardization Design Goals and Principles.....	4-18
4.3.1.10.2	Interchangeability Design Goals and Principles.....	4-19
4.3.2	Design Tools.....	4-21
4.3.2.1	Analytical.....	4-21
4.3.2.2	Mockups.....	4-23
4.3.2.3	Simulation and Virtual Reality.....	4-23
4.3.2.4	Handbooks and Other Reference Documents.....	4-25
4.3.2.5	Artificial Intelligence.....	4-25
4.3.2.5.1	Expert Systems.....	4-26
4.3.2.5.1.1	Rule-Based Expert Systems.....	4-26
4.3.2.5.1.2	Model-Based Expert Systems.....	4-28
4.3.2.5.2	Fuzzy Logic.....	4-28

PARAGRAPH

PAGE

4.3.2.5.3	Neural Networks.....	4-29
4.4	Maintainability Analyses and Test.....	4-31
4.4.1	Analyses.....	4-31
4.4.1.1	Objectives of Maintainability Analyses.....	4-31
4.4.1.2	Typical Products of Maintainability Analyses.....	4-32
4.4.1.3	Commonly Used Maintainability Analyses.....	4-32
4.4.1.3.1	Equipment Downtime Analysis.....	4-32
4.4.1.3.2	Maintainability Design Evaluation.....	4-33
4.4.1.3.3	Failure Modes and Effects Analysis (FMEA).....	4-34
4.4.1.3.4	Testability Analysis.....	4-37
4.4.1.3.4.1	Dependency Analysis.....	4-38
4.4.1.3.4.2	Dependency Analysis Tools.....	4-40
4.4.1.3.4.3	Other Types of Testability Analyses.....	4-40
4.4.1.3.5	Human Factors Analysis.....	4-40
4.4.1.4	Quantitative Measures of Maintainability.....	4-42
4.4.1.4.1	Maintainability Models and Maintenance Activities Block Diagrams.....	4-43
4.4.1.5	Qualitative Maintainability Factors.....	4-44
4.4.1.6	Predictions, Allocations, and Assessments.....	4-45
4.4.1.6.1	Maintainability Prediction.....	4-45
4.4.1.6.1.1	Maintainability Prediction in Accordance with MIL-HDBK-472....	4-46
4.4.1.6.2	Maintainability Allocation.....	4-47
4.4.1.6.2.1	Failure Rate Complexity Method.....	4-48
4.4.1.6.2.2	Variation of the Failure Rate Complexity Method.....	4-50
4.4.1.6.2.3	Statistically-Based Allocation Method.....	4-50
4.4.1.6.2.4	Equal Distribution Method.....	4-51
4.4.1.6.3	Maintainability Assessment.....	4-51
4.4.2	Test.....	4-51
4.4.2.1	Objectives.....	4-52
4.4.2.2	Types of Testing.....	4-52
4.4.3	Statistical Distributions Used in Maintainability Models.....	4-53
4.4.3.1	Lognormal Distribution.....	4-54
4.4.3.2	Normal Distribution.....	4-55
4.4.3.3	Exponential Distribution.....	4-56
4.5	Data Collection and Analysis.....	4-58
4.5.1	Types of Data.....	4-58

PARAGRAPH	PAGE
4.5.1.1 Development Data	4-58
4.5.1.2 Field Data.....	4-60
4.5.2 Sources of Data	4-60
4.5.3 Data Analysis Techniques	4-62
4.5.3.1 Data Used Explicitly for Compliance Verification.....	4-63
4.5.4 Uses of Data.....	4-64

APPENDIXES

Appendix A. Acquisition Guidance, Templates for Preparing Maintainability Section of Solicitation, and Guidance for Selecting Sources.....	A-1
Appendix B. Test and Demonstration Methods.....	B-1
Appendix C. Design Guidelines (Volume II of Handbook).....	C-1
Appendix D. Predictions.....	D-1
Appendix E. Phasing of Maintainability Elements.....	E-1
Appendix F. Maintainability References.....	F-1
Appendix G. Glossary.....	G-1

FIGURES

Figure 1: Different Combinations of MTBF and MTTR Yield the Same Inherent Availability	2-3
Figure 2: Some Key Disciplines to Which Maintainability is Related.....	2-8
Figure 3: QFD House of Quality	3-3
Figure 4: Example Excerpt of House of Quality	3-4
Figure 5: Major Categories of Maintenance.....	4-7
Figure 6: The Steps in an RCM Approach to Identifying Preventive Maintenance	4-8
Figure 7: The Human Information Processing System.....	4-10
Figure 8: Interactions Between Human and Product.....	4-11
Figure 9: Steps in a General Approach for the Physical Development of a Maintainability Expert System.....	4-28
Figure 10: Fuzzy Logic Set Membership.....	4-29
Figure 11: Typical Neural Network Configuration.....	4-30
Figure 12: Steps in an FMEA	4-36
Figure 13: Typical FMEA Worksheet.....	4-36
Figure 14: Abbreviated Results from FMEA of a Solid Propellant Rocket Motor.....	4-37

FIGURES (Continued)

Figure 15:	Simple System Showing Test Dependencies	4-38
Figure 16:	Maintenance Activities Block Diagram.....	4-43
Figure 17:	Example of Maintainability Allocation.....	4-50
Figure 18:	Example FRACAS Form.....	4-59
Figure A-1:	Sections of a Government Solicitation or Contract.....	A-8
Figure A-2:	Example Wording for a Statement of Objectives.....	A-10
Figure A-3:	Checklist for Evaluating Maintainability Portion of a Proposal.....	A-22
Figure B-1:	Time Phasing of Maintainability Testing.....	B-2
Figure B-2:	Procedure for Maintainability-Index Selection.....	B-9
Figure B-3:	OC Curve for Test A	B-29
Figure B-4:	OC Curve for Test B.....	B-30
Figure B-5:	OC Curve for Test Method 2	B-32
Figure B-6:	OC Curve for Test Method 3	B-36
Figure B-7:	Distribution of Means.....	B-43
Figure B-8A:	Acceptable Combinations of Dual Requirements	B-49
Figure B-8B:	Values Acceptable to Dual Requirement of Maximum Values of Two Percentiles.....	B-49
Figure B-8C:	Superimposition of Figure B-8A on B-8B.....	B-50
Figure B-8D:	OC Curve for Test Method 8	B-54
Figure B-8E:	Probability of Passing Test A.....	B-55
Figure B-8F:	Probability of Passing Test B ₁	B-56
Figure B-8G:	Probability of Passing Test B ₂	B-56
Figure B-9:	OC Map Relative to a Given Dual Requirement	B-57
Figure B-10:	Node Consisting of Fan-In Branches, a Fan-Out Origin, and Fan- Out Branches.....	B-79
Figure C-1:	Redundancy BIT.....	C-5
Figure C-2:	Wrap-Around BIT	C-6
Figure D-1:	RI Data Analysis Sheet - A.....	D-12
Figure D-2:	RI Data Analysis Sheet - B.....	D-12
Figure D-3:	MTTR Submodels	D-14
Figure D-4:	Definitions of MTTR Submodel Terms	D-15
Figure D-5:	Matrix For Correlating FD&I Features With RIs	D-23
Figure D-6:	Fault Isolation Output and RI Correlation Tree	D-24
Figure D-7:	Manual Fault Isolation Output And RI Correlation Tree (Partial).....	D-24
Figure D-8:	Sample Maintenance Flow Diagram.....	D-26
Figure D-9:	Example Time Synthesis Analysis.....	D-28
Figure D-10:	Maintenance Correlation Matrix Format	D-29
Figure D-11:	Standard Screws	D-32
Figure D-12:	Hex or Allen Set Screws.....	D-32
Figure D-13:	Captive Screws.....	D-32

FIGURES (Continued)

Figure D-14:	Dzus Fasteners.....	D-33
Figure D-15:	Tridair Fastener.....	D-33
Figure D-16:	Thumbscrews.....	D-33
Figure D-17:	Machine Screws.....	D-34
Figure D-18:	Nuts or Bolts.....	D-34
Figure D-19:	Retaining Rings.....	D-35
Figure D-20:	Drawhook Latch.....	D-35
Figure D-21:	Spring Clip Latch-Catch.....	D-35
Figure D-22:	Butterfly Latch.....	D-36
Figure D-23:	ATR Latch.....	D-36
Figure D-24:	Lift and Turn Latch.....	D-36
Figure D-25:	Slide Lock Latch.....	D-37
Figure D-26:	Terminal Post Connections.....	D-37
Figure D-27:	Screw Terminal Connections.....	D-37
Figure D-28:	Termipoint Connection.....	D-38
Figure D-29:	Wirewrap Connection.....	D-38
Figure D-30:	Taperpin Connection.....	D-38
Figure D-31:	PCB Connection.....	D-39
Figure D-32:	BNC Connectors.....	D-39
Figure D-33:	Quick Release Coax Connectors.....	D-39
Figure D-34:	Friction Locking Connector.....	D-40
Figure D-35:	Friction Locking Connector with Jackscrew.....	D-40
Figure D-36:	Threadlocking Connector.....	D-40
Figure D-37:	Slide Locking Connector.....	D-41
Figure D-38:	Dip ICs.....	D-41
Figure D-39:	Guided CCAs.....	D-41
Figure D-40:	Guided CCAs with a Tool.....	D-42
Figure D-41:	Non-guided CCAs.....	D-42
Figure D-42:	Modules.....	D-42
Figure D-43:	Crimp Lugs.....	D-43
Figure D-44:	Form Leads.....	D-43
Figure D-45:	Soldering Terminal Posts.....	D-43
Figure D-46:	Soldering PCB Connections.....	D-43
Figure D-47:	Desoldering with a Braided Wick.....	D-44
Figure D-48:	Desoldering Using a Vacuum.....	D-44
Figure D-49:	Form Flat Pack Leads.....	D-44
Figure D-50:	Panels, Doors and Covers.....	D-45
Figure D-51:	Drawers.....	D-45
Figure D-52:	Display Lamps.....	D-45
Figure E-1:	Life Cycle Phases of a Product.....	E-2
Figure E-2:	Application of Activities by Phase.....	E-4

TABLES

Table I:	Scope of Key Topics.....	1-1
Table II:	Maintainability and Related Tasks.....	1-3
Table III:	Program Activity Characteristics and Guidelines for Supplier-Product Classifications.....	1-5
Table IV:	Task Cross Reference: Old MIL-HDBK-470 to new MIL-HDBK-470A..	1-8
Table V:	Operational and Design Maintainability Contrasted.....	2-2
Table VI:	Types and Purposes of Design Reviews.....	4-3
Table VII:	Risks and Consequences of Not Making BIT Part of Product Design	4-17
Table VIII:	Comparison of AI Techniques	4-25
Table IX:	First Order Dependency Model for Simple System	4-39
Table X:	Typical Types of "In-Place" Repair and Maintenance.....	4-48
Table XI:	Allocation Using Failure Rate Complexity Method.....	4-49
Table XII:	Example of Equal Distribution Method	4-51
Table XIII:	Risks and Consequences of a Testing Approach That is Not Integrated....	4-52
Table XIV:	Values of $z(t'_{1-\alpha})$ Most Commonly Used in Maintainability Analysis...	4-55
Table XV:	Values of k_e for Specified α	4-57
Table XVI:	Example Data Fields From an Existing R&M Data Base.....	4-61
Table B-I:	Test Method Matrix.....	B-7
Table B-II:	Factors Affecting the Suitability of a Specified Maintainability Index for Maintainability Demonstration	B-11
Table B-III:	Causes of Discrepancies Between Test and Field Results.....	B-11
Table B-IV:	Example of Step-by-Step Stratification.....	B-14
Table B-V:	Calculations of Relative Frequency of Occurrence and Sample Size for Example Radar Equipment.....	B-15
Table B-VI:	Stratification Procedure	B-17
Table B-VII:	Failure Mode Selection.....	B-19
Table B-VIII:	Standardized Normal Deviates	B-25
Table B-IX:	Sampling Plans for Specified p_0 , p_1 , α , and β When p_0 is Small (e.g., $p_0 < 0.20$).....	B-35
Table B-X:	Plan A ₁ . Observations Exceeding the Value of the Mean.....	B-51
Table B-XI:	Plan B ₁ . Observations Exceeding $M_{\max} = 90$ Percentile.....	B-52
Table B-XII:	Plan B ₂ . Observations Exceeding $M_{\max} = 95$ Percentile.....	B-53
Table B-XIII:	ϕ vs. β	B-59
Table B-XIV:	Acceptance Table for \tilde{M}_{ct} or \tilde{M}_{pm} ; Sample Size = 50	B-61
Table B-XV:	Acceptance Table for M_{\max_c} or $M_{\max_{pm}}$; Sample Size = 50.....	B-62
Table B-XVI:	Penalty Values, P, for LFSR Signature Analyzers Implementing Primitive Polynomial of Degree, k.....	B-80
Table B-XVII:	Representative Faults for the Fault Equivalence Classes.....	B-82

TABLES (Continued)

Table B-XVIII: Sample Sizes Used to Obtain Lower Bound on Fault Coverage Using Fault Simulation Procedure 2	B-84
Table B-XIX: Sample Size Used to Accept/Reject Lower Bound on Fault Coverage Using Simulation Procedure 3	B-85
Table C-I: Categories of Product Subsystem, Equipment, and Component Maintainability Guidelines.....	C-1
Table C-II: Alpha Prefixes for Guidelines	C-3
Table C-III: Categories of Part Types and Technologies from RL-TR-92-12, Vol. I.....	C-6
Table C-IV: Inherent Testability Checklist.....	C-7
Table D-I: MTTR Elements	D-4
Table D-II: MTTR Elements for Prediction Procedure.....	D-4
Table D-III: Symbols Used in the MFD.....	D-25
Table D-IV: Elemental Maintenance Actions.....	D-30
Table D-V: Common Maintenance Tasks.....	D-31

This page has been left blank intentionally.

SECTION ONE

1.0 SCOPE AND PURPOSE OF HANDBOOK.

1.1 Scope. Unlike previous handbooks which focused only on maintainability, this document provides information to help the reader view maintainability in the context of an overall systems engineering effort. The handbook defines maintainability, describes its relationship to other disciplines, addresses the basic elements common to all sound maintainability programs, describes the tasks and activities associated with those elements, and provides guidance in selecting those tasks and activities. Due to the many aspects of maintainability and the large number of related disciplines, the depth in which some topics are covered is necessarily limited. Table I summarizes where the scope of the coverage of key topics is limited. Whenever possible, references are given in the text to documents having more detailed information on a topic.

TABLE I. Scope of Key Topics.

Topic	Scope Limited To
Availability and Readiness	Basic concepts, effect of maintainability.
Life Cycle Costs	Basic definitions, description of effect of maintainability on various cost elements.
Manufacturing	Description of impact of manufacturing on maintainability.
Human Engineering	Description of human engineering discipline and relationship to maintainability.
Safety	Description of relationship to maintainability.
Testability	Definition as subset of maintainability, description of concepts, general information on key issues, design techniques and guidelines, definitions of metrics, and demonstration testing (Appendix B). Testability is covered in more detail in other handbooks and standards such as MIL-HDBK-2165.
Logistics Support	General discussion with emphasis on how it is affected by maintainability.
Reliability-centered Maintenance	Introduction with general procedure outlined.
Predictions	Description of applications with the most used method from MIL-HDBK-472 included in Appendix D.

This Appendix is for guidance only and cannot be cited as a requirement. If it is, the contractor does not have to comply.

1.1.1 Purpose of the Handbook. This handbook has four purposes:

1. To provide insight into the reasons for specifying maintainability in a product¹ development program and to describe the structural elements of a sound maintainability program
2. To describe the design, test, and management tasks and activities that can be conducted to meet the objective and achieve the required levels of maintainability and how to incorporate these tasks in a tailored program

¹The general term "product" will be used to mean system, equipment, or item. It could be a vehicle, a transmission, or an engine, whatever is being developed for the customer.

3. To provide guidance for structuring a Government solicitation to ensure that these tasks and activities are addressed
4. To provide guidance for evaluating how well maintainability is addressed in proposals submitted in response to a Government solicitation

1.1.2 Using the Handbook. Maintainability managers and engineers² should use this document when developing and implementing a sound maintainability program. It does not prescribe a set of tasks that must be included for every product development effort but describes those objectives common to all maintainability programs. It then provides guidance in *selecting only those tasks that best support the achievement of those objectives* for the product development effort in question. The handbook emphasizes and encourages the tailoring of each maintainability program to account for schedule and budget constraints, technical risk, and customer needs and requirements. Even though templates are provided to assist in developing the maintainability portions of a statement of work and specification, *they should not be used in "boilerplate" fashion.* To assist the reader in structuring an effective maintainability program, Tables II and III are provided. Table II is an overview of maintainability tasks and activities and relates them to the maintainability elements discussed in Section 4 of the handbook. Table III relates maintainability activities to representative supplier/product classifications.

Although the principal maintainability tasks used in product development efforts are described in this handbook, the reader is also referred to other documents for detailed "how to" procedures. Detailed design guidelines, prediction methodology, acquisition guidance, and test methods and plans are included as appendixes A through E. Appendix F lists all references and also includes a listing of maintainability software tools.

As an aid to those readers familiar with the former MIL-STD-470B (reissued as MIL-HDBK-470 in June 1995), task cross references are provided in Table IV.

1.2 Applicable Documents. See Appendix F.

(NOTE: Text continues with Section 1.5 following Tables II, III, and IV.)

² Many companies may not use the job titles "maintainability engineer" or "maintainability manager." In many cases, specialists in maintainability have been replaced by designers or other engineers who are assigned the responsibility for maintainability. For convenience, "maintainability engineer" and "maintainability manager" are used interchangeably in this handbook.

TABLE II. Maintainability and Related Tasks.

Type of Activity	Tasks and Description	Relevant to Elements				
		Understand Needs	Understand the Design	Design for Maintain.	Validate Maintain.	Monitor Opnl. Perf.
DESIGN	Testability and Diagnostics. Designing and incorporating features for determining and isolating faults.			X		
	Design Reviews. Formal or informal independent evaluation and critique of a design to identify and correct hardware or software deficiencies.	X		X	X	
	Environmental Characterization. Determination of the operational environment in which maintenance is expected to be performed.		X	X		
	Supplier Control. Monitoring suppliers' activities to assure that purchased hardware and software will have adequate maintainability.	X			X	X
	Standardization and Interchangeability. Designing for the use of and incorporating common items. Designing so items can be exchanged without alteration or change.			X		
	Human Engineering. Designing equipment so that they may be safely, easily, and efficiently used, operated, and maintained by the human element of the system.			X		
ANALYSIS	Testability. Systematically determining the coverage and adequacy of fault detection and isolation capability. Includes dependency and fault modeling.		X	X		
	Human Factors. Analyzing the design to ensure strength, access, visibility and other physical and psychological needs/limitations of users, operators, and maintainers are adequately addressed.		X	X	X	
	Equipment Downtime Analysis. Determine and evaluate the expected time that system will not be available due to maintenance or supply.	X		X		
	Failure Modes, Effects & Criticality Analysis (FMECA). Systematically determining the effects of part or software failures on the product's ability to perform its function. This task includes FMEA.			X	X	X
	Failure Reporting Analysis & Corrective Action System (FRACAS). A closed-loop system of data collection, analysis and dissemination to identify and improve design and maintenance procedures.			X	X	X
	Life Cycle Planning. Determining maintainability and other requirements by considering the impact over the expected useful life of the product.	X	X	X	X	X
	Modeling & Simulation. Creation of a representation, usually graphical or mathematical, for the expected maintainability of a product, and validating the selected model through simulation.		X	X		
	Parts Obsolescence. Analysis of the likelihood that changes in technology will make the use of a currently available part undesirable.	X		X	X	
	Predictions. Estimation of maintainability from available design, analysis or test data, or data from similar products.		X	X	X	X
	Repair Strategies. Determination of the most appropriate or cost effective procedures for restoring operation after a product fails.	X		X		
	Quality Function Deployment. Determine product design goals (i.e., product maintainability) from the user's operational requirements.	X	X			
Allocations. Apportion system-level or product-level maintainability requirements to lower levels of assembly.		X	X	X	X	

TABLE II. Maintainability and Related Tasks. (continued)

Type of Activity	Tasks and Description	Relevant to Elements				
		Understand Needs	Understand the Design	Design for Maintain.	Validate Maintain.	Monitor Opnl. Perf.
TEST	Functional Test. Verify product is behaving as intended. Of interest to maintainability engineer are issues related to human factors.		X	X		
	Performance Test. Verifying that the product meets its performance requirements, including maintainability.		X	X	X	
	Verification Test. Testing performed to determine the accuracy of and to update the analytical data obtained from engineering analysis.		X	X	X	
	Demonstration. Formal process conducted by product developer and end customer to determine if specific maintainability requirements have been achieved. Usually performed on production or pre-production items.				X	
	Evaluation. Process for determining the impact of operational and maintenance and support environments on the maintainability performance of the product.				X	X
	Test Strategy and Integration. Determine most effective and economical mix of tests for a product. Ensure integration of tests to minimize duplication and maximize use of test data.	X		X	X	X
OTHER	Benchmarking. Comparison of a supplier's performance attributes to its competitors' and to the best performance achieved by any supplier in a comparable activity.	X	X			
	Statistical Process Control (SPC). Comparing the variability in a product against statistical expectations, to identify any need for adjustment of the production process.	X				
	Market Survey. Determining the needs and wants of potential customers, their probable reaction to potential products, and their level of satisfaction with existing products.	X				
	Inspection. Comparing a product to its specifications, as a quality check.				X	X

TABLE III. Program Activity Characteristics and Guidelines for Supplier-Product Classifications.

*	Product Classification	Product Characteristics					Program Issue	Program Activity Characteristics/Guidelines
		Technology	Unit Cost	Quantities	Safety Concerns			
GENERAL PRODUCT ILLUSTRATION	<u>Passive Items</u> • Dry goods • Books • Handtools • Furniture	Low	Low	Large	None to Low	Reqmts	Customer doesn't specify requirements; suppliers determine quality goals through QFD, surveys, competitor benchmarking, warranty data, etc.	
						Design	Maintainability may not be addressed as a separate function but as part of product quality. Safety and recycling are considerations.	
						Assess	No separate maintainability analyses usually apply. Warranty data and experience tracked.	
						Measure	For products in which quality is driver, none. For others in which service life is a consideration, analysis, test, or both can be used.	
						Ensure	Market dictates length of service. Overdesign typical.	
	<u>Consumer Products</u> • Appliances • Power tools • Cameras • Computers • Electronics	Low to Mod.	Mod.	Mod. to Large	Low to Mod.	Reqmts	Supplier determines requirements based on customer needs. Tailors to warranty requirements and competitive comparable products.	
						Design	Limited maintainability practices used.	
						Assess	Predictions and modeling possibly beneficial.	
						Measure	Some safety testing may be required by law. Some environmental testing may be appropriate. Formal maintainability testing not normally performed.	
						Ensure	Short term warranty may be appropriate.	
	<u>Consumer Durables</u> • Automobiles • Boats	Mod.	Mod. to High	Mod. to Large	Low to High	Reqmts	Maintainability program recommended with allocated goals.	
						Design	Product quality and price prime drivers. Small number of design teams with few members. Testability and diagnostics of some importance. Material selection and processes used are important. Life considerations important.	
						Assess	Predictions and modeling should be used. FMEAs and testability analyses should be performed. Significant testing used to assess progress.	
						Measure	More extensive environmental and some developmental testing usually appropriate.	
						Ensure	Warranty and service contracts applicable.	
INDUSTRIAL	<u>Passive Items</u> • Dry goods • Books • Handtools • Furniture	Low	Low	Large	None to Low	Reqmts	Customer doesn't specify requirements; suppliers determine quality goals through QFD, surveys, competitor benchmarking, warranty data, etc.	
						Design	Maintainability may not be addressed as a separate function but as part of product quality. Safety and recycling are considerations.	
						Assess	No separate maintainability analyses usually apply. Warranty data and experience tracked.	
						Measure	For products in which quality is driver, none. For others in which service life is a consideration, analysis, test, or both can be used.	
						Ensure	Market dictates length of service. Overdesign typical.	

* Supplier Classification

Note: The activity characteristics and guidelines from one classification of product to the next within a given supplier classification are additive. For example, the program activity characteristics and guidelines for Industrial Light Equipment include all those stated for Industrial Passive Items.

TABLE III. Program Activity Characteristics and Guidelines for Supplier-Product Classifications. (continued)

*	Product Classification	Product Characteristics				Program Issue	Program Activity Characteristics/Guidelines
		Technology	Unit Cost	Quantities	Safety Concerns		
INDUSTRIAL	<u>Light Equipment</u> • Computers • Printers • Engines • Recorders	Low	Mod.	Large	Mod.	Reqmts	Customer may specify requirements for unique needs. Most goals internally developed for market.
						Design	Quality, service life, material selection, parts control and environment are typical concerns. Testability and diagnostics of some importance.
						Assess	Modeling usually done to scope design and understand interdependencies. Predictions possibly needed. FMEA and testability analyses should be considered.
						Measure	Development testing may be effective for high quantities and severe operations.
						Ensure	Statistical process control important to control variability.
	<u>Heavy Equipment</u> • Elevators • Escalators • Boilers • Transformers	Low to Mod.	Mod. to High	Mod.	Mod. to High	Reqmts	Translation of customer expressed needs to design specs needed. Surveys, QFD, & competitor benchmarking often beneficial. Government safety requirements common. Allocation of requirements usually required. Comprehensive maintainability program recommended.
						Design	Although quality is important, service life is a driver. Few to many design teams with many members.
						Assess	Modeling is important and FMEA used to understand maintenance and diagnostics needs. Safety, availability & operating costs very important. Customer may require specific analyses.
						Measure	Safety testing common. Customers may require formal demonstrations. Some simulation may be appropriate.
						Ensure	Warranties apply; ability to repair is important; maintenance reporting is strongly recommended.
	<u>Industrial Systems</u> • Aircraft • Railroad engines • Satellites • Medical equip.	High	High	Small to Mod.	High to Critical	Reqmts	Risks need identification, trade analysis may be needed. Allocation of requirements may be needed.
						Design	Safety, availability, operating costs and service life are drivers. Few to many design teams with many members. Built-in test of importance.
						Assess	Modeling, testability analysis, and FMEA are essential to understand maintenance and diagnostics needs. Customer may require specific analyses.
						Measure	Qualification test may be considered.
						Ensure	Obsolete parts and wearout are a concern. Audits and inspections are useful.
	<u>Structures/Facilities</u> • Bridges • Train tracks • Airport • Building power plants • Chemical plants	Low to High	High	Small	High	Reqmts	Extremely long service life requirements.
						Design	Service life and safety essential. Maintainability is important as it supports these requirements. Few to many design teams.
						Assess	Materials selection critical.
						Measure	Extensive model testing & simulation usually effective.
						Ensure	Periodic safety inspections or performance audits.

* Supplier Classification

Note: The activity characteristics and guidelines from one classification of product to the next within a given supplier classification are additive. For example, the program activity characteristics and guidelines for Industrial Light Equipment include all those stated for Industrial Passive Items.

TABLE III. Program Activity Characteristics and Guidelines for Supplier-Product Classifications. (continued)

*	Product Classification	Product Characteristics				Program Issue	Program Activity Characteristics/Guidelines	
		Tech-nology	Unit Cost	Quan-tities	Safety Concerns			
INDUSTRIAL	<u>Passive Items</u> • Uniforms • Food • Helmets • Desks • Dry goods	Low	Low	Large	None to Low	Reqmts	Customer doesn't specify requirements; suppliers determine quality goals through QFD, surveys, competitor benchmarking, warranty data, etc.	
	Design					Maintainability may not be addressed as a separate function but as part of product quality. Safety and recycling are considerations		
	Assess					No separate maintainability analyses usually apply. Warranty data and experience tracked.		
	Measure					For products in which quality is driver, none. For others in which service life is a consideration, analysis, test, or both can be used.		
	Ensure					Market dictates length of service. Overdesign typical.		
MILITARY	<u>Small Weapon Systems</u> • Rifles • Radios • Munitions	Low to High	Mod.	Large	Low to High	Reqmts	Customer usually specifies field maintainability requirements in his terms, translation to design specifications needed. Allocation of requirements usually needed. Maintainability program recommended.	
	Design					Parts and material selection important. Testability and diagnostics are important. Many design teams with many members. Conservative safety margins used.		
	Assess					Predictions usually performed, and sometimes FMECAs and testability analyses.		
	Measure					Government-mandated formal demonstrations common. Sample testing may be effective in production.		
	Ensure					Statistical process control valuable. FRACAS is a must.		
MILITARY	<u>Critical Weapon Systems</u> • Radars • Tanks • Aircraft engines • Smart munitions	High	High	Small to Mod.	High to Critical	Reqmts	Comprehensive program required. Customer specifications need to be translated and allocated. Requirements need to be flowed-down to subcontractors.	
	Design					System must be modeled. Part and material application critical to success. Integrated diagnostics and BIT may be important.		
	Assess					Predictions, testability analyses, and FMECAs necessary. Environment assumptions must be valid.		
	Measure					Developmental component, subsystem, and some product-level testing should be required. Model testing and simulation may be beneficial.		
	Ensure					Warranties and part obsolescence should be considered. Repair and service strategy important.		
		<u>Strategic Weapon Systems</u> • Ships • Aircraft • Satellites • Submersibles	High	High	Small	High to Critical	Reqmts	Extensive allocation of requirements to subsystems and components required. Risks need identification. Trade analysis should be performed. Comprehensive program required.
		Design					Safety and periods of failure-free operation are big drivers. Modeling and predictions are necessary. Integrated diagnostics and BIT are essential.	
		Assess					Predictions and FMEAs usually performed. Emphasis on safety.	
		Measure					Extensive and rigorous testing effective.	
		Ensure					Periodic or continual audits and/or inspections may be beneficial. Lifetime extension often required.	

* Supplier Classification

Note: The activity characteristics and guidelines from one classification of product to the next within a given supplier classification are additive. For example, the program activity characteristics and guidelines for Industrial Light Equipment include all those stated for Industrial Passive Items.

TABLE IV. Task Cross Reference: Old MIL-HDBK-470 to New MIL-HDBK-470A.

MIL-HDBK-470A Section	Tasks from Old MIL-HDBK-470											
	101	102	103	104	201	202	203	204	205	206	207	301
4.2 Management Approach	X	X	X									
4.3 Design for M(t)			X	X	X	X	X	X	X	X		
4.4.1 Analysis				X	X	X	X	X	X		X	
4.4.2 Test				X								X
4.5 Data Collection and Analysis				X		X	X				X	
Appendix B												X
Appendix C										X		
Appendix D					X		X					

Tasks: 101 - Program Plan

102 - Monitor and Control Subcontractors

103 - Program Reviews

104 - Data Collection, Analysis, & Corrective Action

201 - Maintainability Modeling

202 - Maintainability Allocations

203 - Maintainability Predictions

204 - Failure Modes and Effects Analysis

205 - Maintainability Analysis

206 - Maintainability Design Criteria

207 - Maintenance Plan & LSA Inputs

301 - Maintainability & Testability Demonstration

1.3 Definitions, Acronyms and Abbreviations. The following acronyms and abbreviations are used within the main handbook. Definitions and additional maintainability and testability related acronyms and abbreviations may be found in Appendix G: Glossary.

MCMT ₉₅	Maximum Corrective Maintenance Time at a 95% Confidence Level
AI	Artificial Intelligence
A _i	Inherent Availability
AIAG	Automotive Industries Action Group
ANSI	American National Standards Institute
A _o	Operational Availability
ARINC	Aeronautical Radio Incorporated
ASIC	Application Specific Integrated Circuit
ATA	Air Transportation Association
AWM	Awaiting Maintenance (Time)
AWP	Awaiting Parts (Time)
BIT	Built-in-test
BITE	Built-in-test Equipment
CAD	Computer-aided-design
CAM	Computer-aided-manufacturing
CID	Commercial Item Description
CM	Corrective Maintenance
CND	Cannot Duplicate
COTS	Commercial off-the-shelf
CRT	Cathode Ray Tube

MIL-HDBK-470A

DAR	Defense Acquisition Reform
DMH	Direct Maintenance Hours
DMH/MA	Direct Manhours per Maintenance Action
DoD	Department of Defense
DoDISS	Department of Defense Index of Specifications and Standards
DT	Downtime
DT&E	Development Test and Evaluation
EMD	Engineering and Manufacturing Development
EMI	Electromagnetic Interference
EMT	Elapsed Maintenance Time
ETE	External Test Equipment
ETI	Elapsed Time Indicator
FAR	False Alarm Rate
FD	Fault Detection
FD&I	Fault Detection and Isolation
FFD	Fraction of Faults Detectable
FFI	Fraction of Faults Isolatable
FI	Fault Isolation
FMEA	Failure Modes and Effects Analysis
FMECA	Failure Modes, Effects and Criticality Analysis
FRACAS	Failure Reporting, Analysis, and Corrective Action System
FSC	Federal Stock Class
FTA	Fault Tree Analysis
HE	Human Engineering
IC	Integrated Circuit
IEC	International Electrotechnical Commission
IEEE	Institute of Electrical and Electronics Engineers
ILS	Integrated Logistics Support
IOT&E	Initial Operational Test and Evaluation
IPD	Integrated Product Team
LRU	Line Replaceable Unit
LSA	Logistic Support Analysis
MA	Maintenance Action
MACMT	Mean Active Corrective Maintenance Time
MAISAP	Major Automated Information System Acquisition Programs
MDAP	Major Defense Acquisition Programs
MDS	Mission/Design/Series

MDT	Mean Downtime
MICAP	Mission Capability
MLH	Mean Maintenance Labor Hours
$M_{Max\Phi}$	Maximum Maintenance Time at a Specified Confidence Level
MMH/Repair	Mean Manhours per Repair
MMH/FH	Mean Manhours per Flying Hour
MMH/OH	Mean Manhours per Operating Hour
MR	Maintenance Rate
MTBF	Mean Time Between Failures
MTBM	Mean Time Between Maintenance
MTBPM	Mean Time Between Preventive Maintenance
MTTR	Mean Time To Repair
MTTRF	Mission Time to Restore Functions
MTTRS	Mean Time to Restore System
MTTS	Mean Time To Service
MTUT	Mean Equipment Corrective Maintenance Time To Support a Unit of Operating Time
NASA	National Aeronautics and Space Administration
NATO	North Atlantic Treaty Organization
NDI	Non-developmental Item
NRTS	Not Repairable This Station
O&M	Operation and Maintenance
P&C	Production and Construction
PAT	Process Action Team
PCB	Printed Circuit Board
PM	Preventive Maintenance
PR&P	Product Retirement and Phase-out
RAC	Reliability Analysis Center
RAMS	Reliability and Maintainability Symposium
R&D	Research and Development
R&M	Reliability and Maintainability
RCM	Reliability-centered Maintenance
RFP	Request for Proposal
RI	Replaceable Item
R/R	Remove and Replace
RTOK	Retest OK
RU	Replaceable Unit
SAE	Society of Automotive Engineers
SMD	Surface Mount Device

MIL-HDBK-470A

SOO	Statement of Objective
SOW	Statement of Work
SPS	Standard Performance Specification
SRD	Standard Reference Designator
STAMP	System Testability and Maintenance Program
STAT	System Testability Analysis Tool
TR	Technical Report
TSMD	Time Stress Measurement Device
VE	Virtual Environment
VR	Virtual Reality
WSTA	Weapon System Testability Analyzer
WUC	Work Unit Code

This page has been left blank intentionally.

SECTION TWO

2.0 THE CONCEPT OF MAINTAINABILITY.

What is maintainability and why is it important? Is maintainability related to reliability, weight, safety, purchase price, ease of manufacture, finish, functional performance, and other requirements? As explained in this introduction, if a product is to be maintainable, the concept of maintainability, its relationship to other disciplines, and its contribution to product value must be understood by the maintainability engineer and design team.

2.1 What is Maintainability? Different textbooks and other reference documents define maintainability in slightly different ways. However, consolidating the ideas in these definitions yields the following definition:

Maintainability. The relative ease and economy of time and resources with which an item can be retained in, or restored to, a specified condition when maintenance is performed by personnel having specified skill levels, using prescribed procedures and resources, at each prescribed level of maintenance and repair. In this context, it is a function of design.

In succeeding sections, this definition will be examined in more detail. For now, it is sufficient to note that maintainability, a design characteristic, concerns the relative ease and cost of preventing failures (retaining an item in a specified condition) or correcting failures (restoring an item to a specified condition) through maintenance actions³.

Maintainability is a design parameter. Although other factors, such as highly trained people and a responsive supply system, can help keep downtime to an absolute minimum, it is the inherent maintainability that determines this minimum. Improving training or support cannot effectively compensate for the effect on availability of a poorly designed (in terms of maintainability) product. Minimizing the cost to support a product and maximizing the availability of that product are best done by designing the product to be reliable and maintainable.

Testability, an important subset of maintainability, is a design characteristic that allows the status (operable, inoperable or degraded) of an item to be determined, and faults within the item to be isolated in a timely and efficient manner. The ability to detect and isolate faults within a system, and to do so efficiently and cost effectively, is important not only in the field, but also during manufacturing. All products must be tested and verified prior to release to the customer. Paying attention to testability concerns up front will pay benefits during the testing phases of manufacturing. Therefore, a great deal of attention must be paid to ensuring that all designs incorporate features that allow testing to occur without a great deal of effort. Design guides and analysis tools must be used rigorously to ensure a testable design. Not doing so leads to greater costs in the development of manufacturing and field tests, as well as in the development of test

³ In designing for maintainability, we want to develop a product that is *serviceable* (easily repaired) and *supportable* (can be cost-effectively kept in or restored to a usable condition).

equipment. Trade-offs must be made up front on the use of built-in-test (BIT) versus other means of fault detection and isolation. Further, the expected percentage of faults that can be detected and isolated to a specified or desired level of ambiguity must be determined as an important input to the logistics analysis process. The consequences of poor testability are higher manufacturing costs, higher support costs, and lower customer satisfaction.

No matter how they may define maintainability, commercial and military users measure the performance of products in their own ways, to suit their own needs. A car owner may be most concerned with low cost of operation and few visits to the repair shop. An airline may be most concerned with staying on schedule. These measures may or may not include factors totally determined by the design. So, the way in which a customer measures the maintainability of a product in use may not be meaningful to a designer, and a translation from the user's measures to measures more appropriate for design may be needed. Table V shows how operational (the user's) maintainability and design maintainability differ. Also see Appendix A.

TABLE V. Operational and Design Maintainability Contrasted.

Design Maintainability	Operational Maintainability
<ul style="list-style-type: none"> • Used to define, measure and evaluate supplier's program • Derived from operational needs • Selected such that achieving them allows projected satisfaction of operational maintainability • Expressed in design parameters • Includes only effects of design and manufacturing • Typical terms <ul style="list-style-type: none"> - MTTR (mean-time-to-repair) - A_i (inherent availability) 	<ul style="list-style-type: none"> • Used to describe performance when operated in planned environment • Not normally appropriate for contract requirements • Used to describe needed level of maintainability performance in actual use • Expressed in operational values • Includes combined effects of item design, quality, installation environment, maintenance policy, repair, delays, etc. • Typical terms <ul style="list-style-type: none"> - MDT (mean-downtime) - A_o (operational availability)

2.2 Effect of Maintainability on Operations and Costs. Maintainability is a measure of a product's performance that affects both mission accomplishment and operations and maintenance costs. Too often we think of performance only in terms of speed, capacity, range, and other "normal" measures. However, a product that requires an inordinate amount of time or other resources to remain in an operable state or to be repaired (i.e., poor maintainability) will either be unavailable when needed or unaffordable.

2.2.1 Operations. Maintainability is important to operations, or mission accomplishment, because it directly affects product availability. Products that never fail would always be available for use, but such products are rare. When a product fails, it must be restored to a functional state as quickly as possible. Regardless of whether components of a product are repairable or not (i.e., they may be throwaway items), it is important that failures can be economically diagnosed and components quickly removed and replaced. Of course, an entire product may not be designed to be repairable; economics may dictate total replacement. Even in these cases, the

product may require calibration or servicing of some type; so maintainability is still an important consideration.

2.2.1.1 Relationship of Reliability and Maintainability. Reliability and maintainability (R&M) are often considered to be complementary disciplines. To understand why, consider the equation for inherent availability (equation 1). Inherent availability reflects the percent of time a product would be available if no delays due to maintenance, supply, etc. (i.e., not design-related) were encountered.

$$A_i = \frac{MTBF}{MTBF + MTTR} \times 100\% \tag{Equation 1}$$

where MTBF is the mean time between failure
and MTTR is the mean time to repair

If the product never failed, the MTBF would be infinite and A_i would be 100%. Or, if it took no time at all to repair the product, MTTR would be zero and again the availability would be 100%. As shown in Figure 1, a given level of A_i (see the next section for a discussion of availability) can be achieved with different values of R&M. As reliability decreases, better maintainability is needed to achieve the same availability and vice versa.

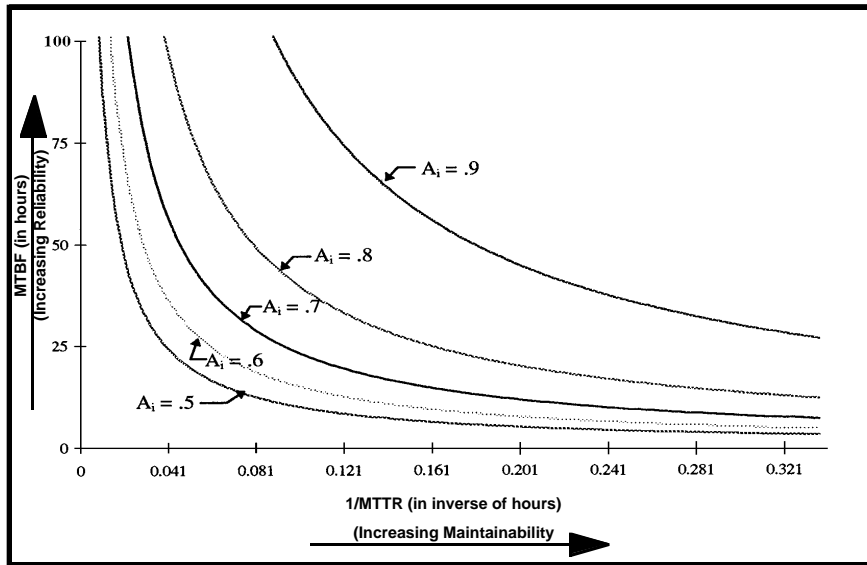

FIGURE 1. Different Combinations of MTBF and MTTR Yield the Same Inherent Availability.

This complementary relationship is important because it means that trades can be made between the two requirements when the end objective is a given availability. For example, if achieving a given level of reliability is too costly or technically difficult, it may be possible to achieve a given availability by increasing the maintainability requirement, and vice versa. Also, some reliability analyses, such as the Failure Modes and Effects Analysis (FMEA), provide data needed by the maintainability engineer. If for no other reason than these, the maintainability and reliability engineers must work hand-in-hand to ensure that the product meets the R&M requirements.

2.2.1.2 Availability and Operational Readiness. Operational availability is similar to inherent availability but includes the effects of maintenance delays and other non-design factors. The equation for operational availability, or A_o , is:

$$A_o = \frac{MTBM}{MTBM + MDT} \quad (\text{Equation 2})$$

where MTBM is the mean time between maintenance
and MDT is the mean downtime

(Note that MTBM addresses all maintenance, corrective and preventive, whereas MTBF only accounts for failures. MDT includes MTTR and all other time involved with downtime, such as delays. Thus, A_o reflects the totality of the inherent design of the product, the availability of maintenance personnel and spares, maintenance policy and concepts, and other non-design factors, whereas A_i reflects only the inherent design.)

Closely related to the concept of operational availability but broader in scope is operational readiness. Operational readiness is defined as the ability of a military unit to respond to its operational plans upon receipt of an operations order. It is, therefore, a function not only of the product availability, but also of assigned numbers of operating and maintenance personnel, the supply, the adequacy of training, and so forth.

Although operational readiness has traditionally been a military term, it is equally applicable in the commercial world. For example, a manufacturer may have designed and is capable of making very reliable, maintainable products. What if he has a poor distribution and transportation system or does not provide the service or stock the parts needed by customers to effectively use the product? Then, the readiness of this manufacturer to go to market with the product is low.

The concepts of availability and operational readiness are obviously related. Important to note, however, is that while the inherent design characteristics of a product totally determine inherent availability, other factors influence operational availability and operational readiness. The maintainability engineer directly influences the design of the product. But, together with the reliability engineer, the maintainability engineer also can affect other factors by providing logistics planners with the information needed to identify required personnel, spares, and other resources. This information includes the identification of maintenance tasks, repair procedures, and needed support equipment.

2.2.2 Life Cycle Costs. In considering the effect of maintainability on costs, the costs associated with the life cycle of a product, from cradle to grave (i.e., the costs to purchase, operate and maintain the product over its planned service life, and then dispose of it), must be addressed. These total costs are called life cycle costs. Each acquisition phase has costs associated with it. Although the phases of acquisition can be defined differently by different customers (or suppliers), life cycle costs are frequently broken out into four categories: research and development, production and construction, operation and maintenance, and retirement and phaseout.

As noted, the phases of acquisition have sets of associated costs (each set is a portion of the total life cycle costs) and the phases can be defined in different ways. Within the Department of Defense (DoD), the life cycle is divided into four phases, which do not necessarily occur in strictly a serial manner but may overlap. The phases of acquisition as defined by Department of Defense Regulation (DoD) 5000.2-R are:

- Phase 0: Concept Exploration
- Phase I: Program Definition and Risk Reduction
- Phase II: Engineering and Manufacturing Development
- Phase III: Production, Fielding/Deployment, and Operational Support

Although not referred to specifically as a phase, Demilitarization and Disposal is described by DoD 5000.2-R as those activities conducted at the end of a system's useful life. See Appendix A for a more detailed discussion of the acquisition phases as defined in DoD 5000.2-R and Appendix E for a discussion of maintainability activities by phase.

In the commercial sector, the life cycle phases of a product are often defined as follows:

- Customer need analysis
- Design and development (includes DoD phases 0, I, and II)
- Production and construction (includes production portion of DoD Phase III)
- Operation and maintenance (includes operational support portion of DoD Phase III)
- Retirement and phase-out (equivalent to Demilitarization and Disposal)

2.2.2.1 Research and Development (R&D) Costs (DoD Phases 0, I, and II). This category includes the cost of feasibility (trade) studies; system analyses (support concept development); detailed design and development (including software); fabrication, assembly, and test of engineering models; initial system testing and evaluation; and associated documentation. The cost attributable to maintainability at this stage is relatively high. Depending upon system complexity, the maintainability engineer may need to implement design approaches that could easily account for 10% of the development costs, especially if extensive BIT and diagnostics are

involved, to meet the maintainability requirements. Remember, however, that investments in maintainability made early in a program can significantly reduce downstream operation and maintenance costs. The goal during research and development should be to make investments that will reduce the life cycle costs to the lowest possible value.

The design approaches recommended by the maintainability engineer must be based upon the customer's requirements, the operational environment, experience, field surveys and interviews, and trade studies.

2.2.2.2 Production and Construction (P&C) Costs (Part of DoD Phase III). This category includes the costs of fabrication, assembly, and testing of production models; establishment of the initial logistic support requirements; facility construction; production operations and quality control; development of training courseware; and the integration of a software support plan. Costs associated with maintainability in this phase are primarily driven by initial operational test and evaluation, and demonstration testing. For the first time, the focus is on software and BIT, and close surveillance is required to anticipate and correct problems. Costs incurred during R&D and P&C should be viewed as an investment to ensure product availability and a low total cost of ownership.

2.2.2.3 Operation and Maintenance (O&M) Costs (Part of DoD Phase III). This category can be considered the costs of consumer or user ownership. Included are the costs of sustaining operations, personnel and maintenance support, spares and repair parts, consumables, warehousing, shipping, configuration management, modification requirements, technical data changes, software maintenance and configuration control, and operating and maintenance personnel training. During this phase, data collection and tracking, customer site visits, failure analysis, and general integration issues constitute the majority of costs associated with maintainability. The maintainability aspects of engineering changes that occur during this phase must be evaluated.

Maintainability is important to O&M costs because it directly influences the ease and economy with which required maintenance can be performed. Ease and economy translate to the number and qualifications of people required to support a product, the number and types of support equipment needed to perform maintenance, the time required to perform maintenance (cycle time and touch labor time⁴), and the degree of safety (of both the product and the people) with which maintenance can be performed. Although many other factors can affect the number of support personnel and other elements of operating and support costs, the level of maintainability designed into the product is an important driver of these costs. Indeed, if the maintainability engineer has done a good job, the O&M phase of the product's life cycle should reflect the benefits of a well balanced design: minimal downtime and low (affordable) ownership costs.

⁴ The time that a maintenance person is actually doing work on the product.

2.2.2.4 Product Retirement and Phase-out (PR&P) Costs. This category includes the costs associated with reclamation and disposal of components and materials. In some companies, these costs are the concern of the maintainability engineer. In such cases, even in the R&D phase, the maintainability engineer can anticipate the PR&P phase by addressing in design recommendations: material durability, environmental concerns, statutory regulations governing material disposal, and the methods and locations where reclamation and disposal might be performed. Special attention should be paid to the reclamation of precious metals and the disposal of hazardous or radioactive materials. During PR&P, lessons learned files are updated, and in-depth tear-down analyses of selected components are often conducted to update service life data.

2.2.2.5 Opportunity and Equivalent Costs. *Opportunity* and *equivalent* costs are not a separate category of life cycle costs. Instead, these costs can be associated with any category of life cycle costs. An opportunity cost refers to a loss of revenue or the cost associated with a lost opportunity to invest in a desired manner or to earn income. An equivalent cost is any cost not readily measured in terms of dollars. Two examples follow.

One example of an opportunity cost would be the revenue "lost" by airline A when passengers are re-booked on airline B, after airline A's aircraft was taken out of service because a failure could not be fault isolated in time for the flight. Potential revenue is lost and cannot be recovered. This lost revenue may not normally be recorded as a cost of operation but has the same effect on profit as does any other cost. In this case, the opportunity cost would be an O&M cost.

The next example illustrates both an equivalent cost and an opportunity cost. A military service needs and has sufficient funds to purchase, operate, and maintain 100 new cargo aircraft to meet a mission need over the next 20 years. The quantity of 100 is based on the aircraft meeting certain availability requirements. If an aircraft is bought but falls short of its availability requirements by 10% due to poor maintainability performance, the military customer has two alternatives⁵: meet only 90% of mission requirements (equivalent to having purchased only 90 aircraft) or increase availability. If the first alternative is selected, the equivalent cost would be the inability to perform the mission. If the second alternative is selected (additional aircraft are purchased, an improvement program is implemented, or additional spares and other logistics resources are purchased), funds diverted from other purposes to increase availability would represent an opportunity cost. In either case, the cost could be considered an O&M cost.

2.2.3 Affordability. Affordability means that the customer can afford the life cycle costs of a product. Too often, "purchase price" becomes the sole focus of attention. Of course, purchase price is an important factor to both seller and customer. Too high a purchase price means that few, if any, products will be sold. However, a product that has a low purchase price but is extremely expensive to own and operate is equally hard to sell. Customers also must be able to

⁵ Assume that the aircraft manufacturer cannot be made to improve the aircraft or provide additional aircraft at no cost to the government. In view of actual historical cases, this assumption is not unreasonable.

afford to operate and maintain the product over its lifetime. Affordability is a function of product value and product costs. Product value is a customer perception and is generally a reflection of the degree to which the product meets all of the customers requirements, including maintainability. Product costs, on the other hand, are a hard reality and may be considered a limiting factor on affordability.

Maintainability affects affordability because it affects availability (value) and acquisition and ownership costs. As noted earlier, up-front investments in maintainability increase acquisition costs but will reduce downstream (O&M) costs. Balances, therefore, must be struck between value and costs, and between acquisition costs and operation and maintenance costs.

2.3 Other Relationships. The relationships between maintainability and reliability and between maintainability and life cycle costs have already been discussed. Maintainability is related to many other design and support disciplines, either providing information to them or receiving information from them. These relationships are influenced and supported by a multi-disciplinary approach to developing and manufacturing a product. This approach is referred to by titles such as systems engineering, concurrent engineering, or Integrated Product Development. Maintainability engineers have the responsibility for developing and fostering these relationships, and cannot fulfill their responsibilities unless they are a part of a team effort. Figure 2 shows some of the key disciplines with which maintainability has a relationship. (Note that design is not a related discipline because maintainability *is a function of design*.) Each of these disciplines will be briefly discussed.

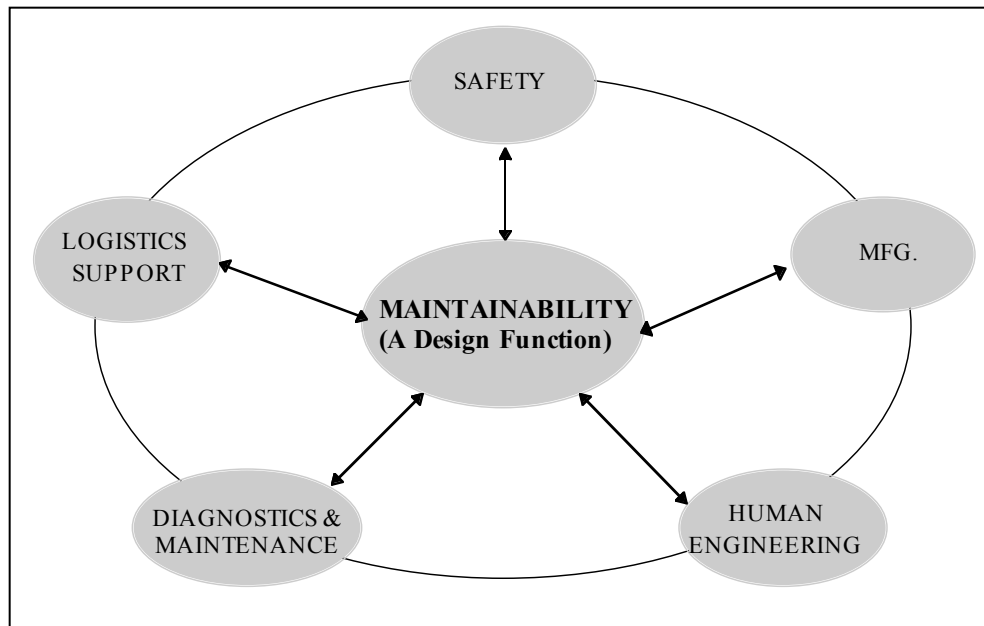

FIGURE 2. Some Key Disciplines to Which Maintainability is Related.

2.3.1 Manufacturing. The manufacturing processes used to transform the design to a tangible product determine if the inherent design maintainability of the product is achieved. It is essential

that the designed maintainability not be compromised by manufacturing requirements, so manufacturing engineers and planners must be involved in the design effort. Without their involvement, maintainability design features or approaches may make the product difficult or too expensive to manufacture. For example, access panels that were included to ensure maintainability requirements are met might be placed in an area where the moldline of the product has compound curves. Moving the panel to an area that is flat or has a simpler surface might still allow good access and improve manufacturability.

2.3.2 Human Engineering. Human Engineering (HE) is the discipline that addresses the safety, effectiveness, role, and integration of people in the operation, use, and maintenance of a product. A part of the total system design process, HE examines how the design of the product affects human welfare and how people interact with the product. These people include users, operators, and maintainers of the product. The physical structure and mechanical operation of the human body and functioning of human senses determine how people can interact with a product. This interaction is usually referred to as the man-machine interface. In some textbooks, maintainability is included as a subset of HE. The ease and economy with which maintenance can be performed is partly a function of how well the designers have considered human limitations and abilities in regard to strength, perception, reach, dexterity, and biology. Certainly, the HE and maintainability engineers have related and often common goals. Close coordination and communication between the two disciplines is, therefore, essential.

Maintainability is directly related to the anthropometric and psychological characteristics of the human beings who will operate and maintain the product. The maintainability engineer must collaborate with the human factors engineer, and consider human engineering factors during design efforts, to ensure the required range of expected human maintainers can indeed accomplish the tasks. Anthropometric characteristics determine how large access openings must be, the need for stands, how far replaceable units may be placed inside a compartment and still be reachable, and so forth. Psychological factors determine what types of warnings are most effective, which way a calibration knob should turn, whether a continuously variable or detented knob should be used, and so forth.

2.3.3 Safety. In designing for maintainability, the maintainability engineer must be constantly aware of the relationship between maintainability and safety. Safety includes designing the product and maintenance procedures to minimize the possibility of damage to the product during servicing and maintenance, and to minimize the possibility of harm to maintenance and operating personnel. From the safety discipline usually come warning labels, precautionary information for maintenance and operating manuals, and the procedures for disposing of hazardous materials and the product.

2.3.4 Diagnostics and Maintenance. Testability has been introduced as a subset of maintainability. It was defined as a design characteristic that allows the status of an item to be determined and faults to be detected and isolated efficiently (or at an "affordable" cost). Diagnostics consists of the manual, automatic, and semi-automatic maintenance hardware,

software, and procedures used to determine status, detect faults, and isolate faults. The required hardware, software, and procedures will depend in large measure on the maintainability of the design (i.e., testability characteristics). Diagnostics are just one aspect of maintenance. All maintenance procedures are determined in large measure by the design. A highly maintainable design will require the least amount of support equipment and the fewest and the simplest procedures.

2.3.5 Logistics Support. Logistics support requirements are greatly affected by maintainability design decisions. The results of maintainability analyses are used by the logistics managers in planning for the following five major categories of logistics support (Note: the categories may be defined differently in other documents; however, the five listed here fairly represent the major elements of logistics):

- Manpower and personnel
- Support and test equipment
- Facilities requirements
- Training development
- Sparing
- Technical manuals

Conversely, the logistics support provided for a product will affect the degree to which the inherent maintainability of a product is realized in actual use. That is, even if the inherent maintainability meets or exceeds the design requirement, the observed operational maintainability will be as expected only if the required logistics support is available. Furthermore, the support concept and any customer constraints or requirements regarding technical data, support equipment, training, (initial, recurring, and due to personnel turnover), field engineering support, spares procurement, contractor depot support, mobility, and support personnel must be understood and considered during all design trade offs and analyses. An increasingly more critical aspect of logistics is obsolescence of internal and piece parts. Sometimes these parts "vanish" because the underlying manufacturing processes are eliminated for ecological or economic reasons. Sometimes the parts themselves are displaced by ones that incorporate new technology but are not identical in form, fit, and function. Whatever the reason, parts (and process) obsolescence is an often overlooked and critical issue. Life buys are one way of coping with obsolescence.

2.4 Maintainability and the Acquisition Process. Maintainability is a customer performance requirement. In the acquisition of a new product, the customer must either select an "off-the shelf" product or must contract with a supplier to provide a product that meets all the performance requirements. The former case typifies the commercial environment. A customer shops around, for example, for an automobile that meets all of his or her performance requirements (gas mileage, size, acceleration, etc.), satisfies the intangibles ("look and feel"), and is affordable. Even customers who do not maintain their own automobiles want a car that is

inexpensive to have repaired (i.e., low O&M costs) and can be repaired quickly (high availability). Competition not only gives the customer a wide range of choice, but it forces manufacturers to design and build cars that are maintainable (and reliable, and comfortable, etc.). Individual customers do not develop design requirements and specifications, contract for the development of a new model, or otherwise directly participate in the development of automobiles. Instead, the manufacturer must determine the requirements through customer surveys, warranty information, and benchmarking of competitors' products.

Likewise, the military services, when purchasing commercial off-the-shelf (COTS)⁶ products do not directly participate in the development of those products. For example, the military services purchase personal computers (PCs) for office use from the same manufacturers as does the general public. These PCs come off the same production lines used to manufacture PCs for the commercial marketplace, have the same design, use the same parts, and often come with the same warranty. So, for a COTS purchase, no design is involved and, hence, design maintainability is not an issue⁷. The use of COTS items does, however, have implications for the support concept. Since customers using COTS items are essentially purchasing on a form, fit, function, and Interface (F³I or F-cubed I) basis, they will not have configuration control of or data describing the internal design of a COTS item. Without configuration control or design data, the customer will have no way to develop and maintain maintenance procedures for repairing the COTS item. Consequently, the support concept will be one of removing and replacing the failed COTS item and sending it back to the supplier for repair.

When the military needs a product not used in the commercial marketplace, or which is similar to a commercial product but must meet much more severe requirements, a new military acquisition program begins. The program may be to develop a completely new product or to modify an existing one. In either case, the customer must explicitly identify to potential suppliers the performance requirements for the product. When more than one supplier is capable of providing the product, these requirements are included in a Request for Proposal (RFP) that is issued by the military customer's procuring activity. Maintainability must be addressed in the RFP.

Appendix A describes the acquisition process, explains how the process is being affected by Defense Acquisition Reform, and provides more detailed guidance on preparing an RFP and evaluating proposals from a maintainability perspective.

⁶Throughout this handbook, COTS is used to mean either Commercial Off-the-Shelf or Commercial Item.

⁷ Design of interfaces when the COTS is a component or subsystem of a larger product being developed for the customer is, of course, another matter. For example, the ability to detect that the COTS item has failed, providing access to remove and replace the item, identifying any tools or support equipment needed to calibrate the item, and developing the procedures associated with these activities will be major maintainability concerns.

This page has been left blank intentionally.

SECTION THREE

3.0 OBJECTIVE OF A MAINTAINABILITY PROGRAM

The objective of a sound maintainability program is to design and manufacture a product that is easily and economically retained in, or restored to, a specified condition when maintenance is performed by personnel having specified skill levels, using prescribed procedures and resources, at each prescribed level of maintenance and repair. Since maintainability *is a true design characteristic*, attempts to improve the inherent maintainability of a product after the design is "frozen" usually are expensive and inefficient. Nevertheless, as previously mentioned, operational maintainability depends on other factors, most notable the support system, that can negate the best efforts of the designer. For example, if an insufficient number of spare parts are purchased, or it takes an inordinate amount of time to get those parts where and when they are needed, then no level of maintainability will be adequate. Poorly trained maintenance personnel will also cause maintainability to suffer. So although this handbook necessarily concentrates on achieving maintainability through sound planning, engineering, design, test, and manufacturing, remember that an adequate support system (spares, people, training, etc.) is essential to capitalize on the inherent maintainability characteristics of the product. (Note: the "sum" of design maintainability and the needed logistics support is sometimes referred to as *supportability*.)

Six essential steps, or sub-objectives, are needed to meet the overall objective of a sound maintainability program:

- Understand the Customer's Maintainability Needs - determine the required level of maintainability as will be measured by the user during actual use of the product
- Integrate Maintainability with the Systems Engineering Process - make the maintainability activities conducted during design and manufacturing an integral part of the product and processes design effort
- Thoroughly Understand the Design - understand the maintainability of the design and the maintenance required for the product
- Design for Desired Level of Maintainability - use proven design approaches to make needed maintenance safe, economical, and easy to perform
- Validate the Maintainability through Analysis and Development Test - conduct analyses, simulation, and testing to uncover maintainability problems, revise the design, and validate the effectiveness of the redesign
- Monitor and Analyze Operational Performance - assess the operational maintainability of the product in actual use to uncover problems, identify needed improvements, and provide "lessons learned" for incorporation in handbooks and for refining modeling and analysis methods

Each of these steps will be discussed in detail.

3.1 Understand the Customer's Maintainability Needs. Understanding the customer's maintainability needs is the first and most obvious step in meeting the objective of a maintainable product. It is important that the level of maintainability addressed here is that which is measured by the user, the operational maintainability, not necessarily that measured during design and development. Many factors can affect operational maintainability, not just the design characteristics of the product or the manufacturing processes used to make the product. This point will be addressed later in Section 3.6.

An important part of understanding customer needs is to collect and study lessons learned on prior products, preferably products similar to the one being acquired. By learning which problems have plagued products in the past, the maintainability engineer can adopt design approaches that reduce if not eliminate the problem in the new product.

Quantitative maintainability requirements should be derived using the same process used to derive other product design requirements. This process consists of performing a needs analysis and through the use of tools such as Quality Function Deployment (QFD). QFD is a tool for translating defined customer requirements into appropriate design requirements at each stage of design and development. The method uses a matrix known as the House of Quality, as depicted in Figure 3. Following are definitions of the terms used in the House of Quality.

<i>Whats</i>	- The product characteristics, functions, or levels of performance wanted by the customer. These are the customer needs or requirements. The <i>Whats</i> are sometimes divided into Primary, Secondary, and Tertiary requirements. Examples of each for a fighter aircraft are, respectively, Operating Characteristics, Sorties, and 4 Sorties per Day.
<i>Hows</i>	- The ways in which the <i>Whats</i> can possibly be met. Also called design requirements. A <i>How</i> for the fighter sortie requirement might be a product availability of 0.92
Importance	- The value or importance placed by the customer on each <i>What</i> . Typically stated as Greatest, Average, or Least.
<i>Hows to Whats Relationships</i>	- The relative strength of the relationship between a <i>What</i> (a requirement) and a specific <i>How</i> . Typically stated as Very Strong, Strong, or Weak or a corresponding numerical value.
Weighted Importance	- The importance of each <i>How</i> based on either its <i>How to What</i> relationship value and number of tertiary <i>Whats</i> (absolute weighting) or the relationship value, risk, and number of tertiary <i>Whats</i> (relative).

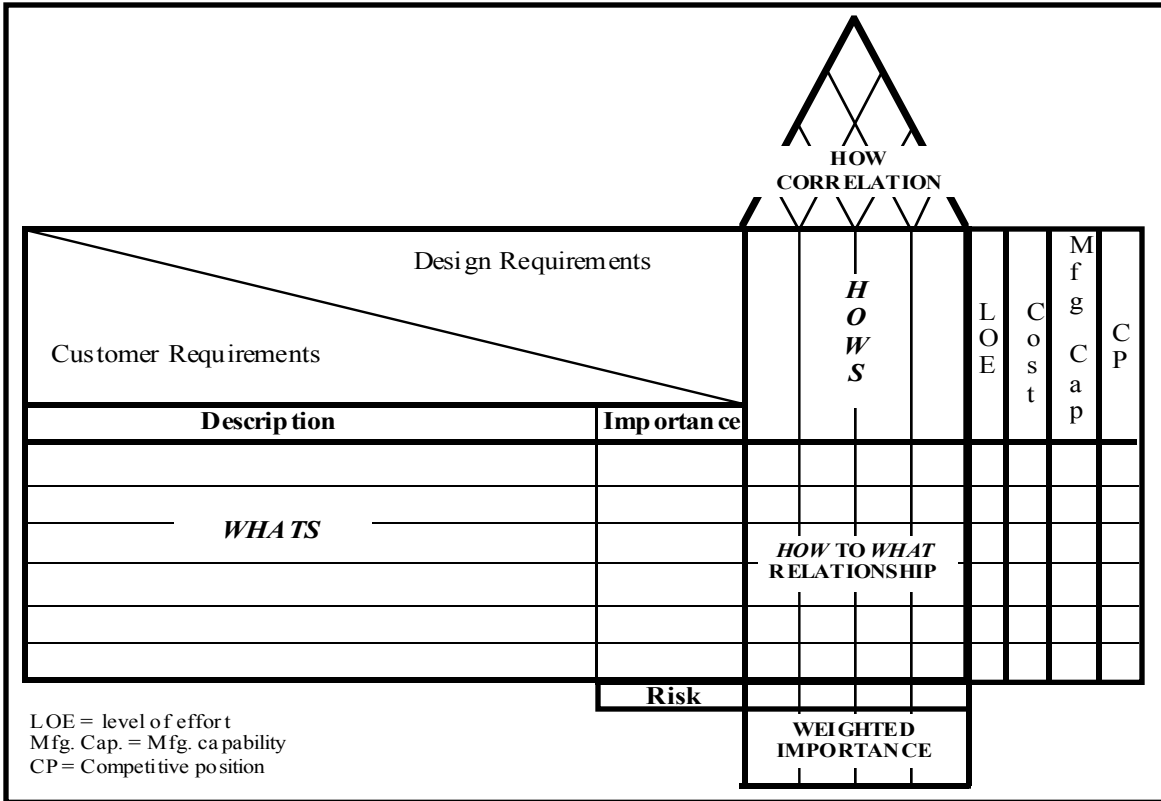

FIGURE 3. QFD House of Quality.

Weighted Importance is calculated as follows:

$$\text{Relative weight} = \sum_{i=1}^N (\text{Relationship value} \times \text{importance factor})_i$$

Rank Ordered

$$\text{Absolute weight} = \sum_{i=1}^N (\text{Relationship values})_i$$

Rank Ordered

How Correlation - The strength of the technical interrelationships between the *How*s. Typically stated as Very Strong, Strong, or Weak.

Risk - The degree of technical and cost risk associated with each *How*. Typically stated as Greatest Average, or Least.

N - The total number of requirements (*Whats*).

Briefly, the following steps are used in the QFD approach (see Figure 4).

1. Enter the *Whats* already determined. If necessary, further define the *Whats* as Primary, Secondary, and Tertiary requirements.
2. Determine the *Hows*, the design requirements, based on technical experience and knowledge.
3. Develop *What-How* relationships, assigning a numerical value to each (for example, a Very Strong relationship might be assigned a 5, a Strong relationship a 3, and a Weak relationship a 1). Determining relationships is based on experience and technical knowledge. To provide an easily understood graphical display, symbols, as shown in Figure 4, are used.
4. Define and assign customer importance factor for each of the lowest level (primary, secondary, or tertiary) requirements and the degree of technical and cost risk associated with each *How*. Assign numerical values to the factors and degrees of risk (e.g., Greatest = 5, Average =3, Least =1).

Customer Requirements				Design Requirements			
Primary	Secondary	Tertiary	Importance	DR1	DR2	DR3	
Operational Characteristics	A	A-1	○	⊙	—	△	
		A-2	△	○	⊙	—	
		A-3	⊙	⊙	—	○	
		A-4	○	△	○	△	
	B	B-1	○	△	○	⊙	
		B-2	△	—	⊙	—	
		B-3	⊙	○	—	⊙	
	C	C-1	○	—	⊙	—	
		C-2	△	⊙	—	△	
	D	D-1	○	○	—	⊙	
		D-2	△	—	⊙	—	
		D-3	△	—	△	⊙	
		D-4	⊙	⊙	—	—	
		D-5	○	—	⊙	△	
	E	E-1	△	⊙	○	—	
		E-2	○	○	—	⊙	
				Risk	△	⊙	○
	Weights			Relative	3	1	2
				Absolute	1	2	3

Symbol	Relationships	Importance/Risk
⊙	Very Strong = 5	Greatest = 5
○	Strong = 3	Average = 3
△	Weak = 1	Least = 1
—	None	N/A

FIGURE 4. Example Excerpt of House of Quality.

5. Develop relationships among the *How*s (not shown in Figure 4). Use the same definitions for the strength of the relationship and the corresponding numerical value that were used for the *What-How* relationships. Knowing the relationship among *How*s will be important during trades.
6. Calculate the relative and absolute weights for the *How*s. For each *How* (DR1, DR2, and DR3), sum the relationship values in that column. The results are 39, 35, and 32, respectively. Ranked ordered, the *How*s are given absolute weights of 1, 2, and 3. Now multiply the relationship values in each column by the corresponding importance and add the products yielding the following sums: 117, 67, and 100, respectively. Rank ordered, the relative weights are 1, 3, and 2, respectively, for DR1, DR2, and DR3.
7. Multiply the relative weights by the Risk factors of the *How*s. The products of this multiplication indicate the attention merited by each *How*. DR2 rates the most attention, DR3 the next most, and DR1 the least.

The right-hand side of the complete House of Quality (reference Figure 3) is used to project the relative level of effort, cost, required manufacturing capability, and the supplier's competitive position regarding each *What*. Projections are usually stated as Greatest, Average, and Least.

By using successive QFD "Houses of Quality", with the *How*s from one used as the *Whats* of the next, increasingly more detailed (lower level) requirements can be derived.

3.2 Integrate Maintainability with the Systems Engineering Process. Systems engineering is a top down iterative process involving requirements definition, functional analysis and allocation, synthesis and design, test and evaluation. By integrating the maintainability activities into this process, maintainability requirements will be addressed concurrently with other performance requirements. In this way, maintainability activities will be integrated with all engineering and design activities, thereby avoiding duplicative effort and making the best use of activity outputs. As is discussed in Appendix A, a maintainability program must address this issue (i.e., how design, analysis, and other tasks will be integrated to minimize costs and maximize the use of task products). An integrated, systems approach is essential because maintainability is related to other product characteristics.

3.3 Thoroughly Understand the Design. Thoroughly understanding the design is essential to making the final product maintainable. Accessibility, diagnostic capability, and repair times must be known with as much certainty as time, budget, and technical knowledge allow. Understanding the maintenance needed to support the product during use will help uncover shortcomings in maintainability, as well as determine the level of support (e.g., number of spares) required.

3.4 Design for Desired Level of Maintainability. A maintainable product is the result of a conscious and dedicated effort to incorporate design features that make preventive and corrective maintenance easy, safe, and economical in terms of time and resources. Any product can be maintained given enough time and money, but time and money are pervasive constraints. So it is the responsibility of the design team to design the product so that it can be maintained within these constraints.

An essential aspect of maintainability is determining when a product is malfunctioning and why. The hardware, software, or other documented means used to determine that a malfunction has occurred and to isolate the cause of the malfunction are collectively called *diagnostics*. As products become more complex, diagnostics becomes an essential and critical part of design. For such products, diagnostics is a driver of maintainability because identifying and isolating a problem to its root cause often accounts for the majority of repair time. A diagnostic capability encompasses more than built-in-test (BIT); it includes any automatic, semi-automatic, and manual testing, maintenance aids, technical information manuals, and the effects of personnel and training. So any action performed for the purpose of detecting and isolating malfunctions, including any equipments, data or knowledge used in the performance of such actions can be associated with a diagnostic capability.

Appendix C details many of the design guidelines proven to result in maintainable products.

3.5 Validate the Maintainability through Analysis and Development Test. Three methods of verifying requirements are commonly used. They are inspection, analysis, and test. Inspection is best suited to physical characteristics such as dimensions, weight, and finish. Ideally, it is through analyses that we validate the functional characteristics of a design because analyses are relatively inexpensive compared with testing. However, it is often only through testing that the product's design, and the tools used to create that design, can be truly validated. Testing uncovers unexpected problems or shortcomings. It helps us refine our analytical tools with which we design the product. Testing is the essential development tool that provides the feedback needed by engineers to refine their design and revise their analyses.

Maintainability and testability demonstration tests are conducted to show whether or not a product possesses the requisite maintainability characteristics. The specific approach used for demonstration testing ranges from limited testing done independently by the contractor to extensive tests controlled by the customer. See Appendix B for specific test plans.

Recently, computer simulation in the form of virtual reality (see 4.3.2.3) has allowed some maintainability characteristics of a design to be "evaluated" before any model or prototype is even constructed. Although not a total substitute for testing, virtual reality simulation can reduce the amount of time required by allowing some maintainability aspects of the design to be verified without or with reduced maintainability demonstration and testing.

3.6 Monitor and Analyze Operational Performance. For many products, it is important for the customer, the supplier, or both to monitor the performance of the product in actual use. This monitoring may be done through tracking warranty data, collecting specialized information, customer complaints, and surveys. Monitoring, and subsequent analysis of the data, is done for three reasons:

- Identify performance problems
- Identify needed changes in policy, procedures, or design to resolve performance problems
- Identify and document lessons learned

The first two reasons are somewhat obvious. Despite our best efforts to design properly and to validate the design through development testing, some problems may not evidence themselves until the product has been fielded. It is then important to determine if the problems are serious enough to require correction and, if so, the best means for doing so. If the product is warranted and the problem is covered under that warranty, then the supplier must take the necessary action. If the problem lies in the customer's maintenance policy and procedures, then changes to those items need to be considered.

The third reason, to identify and document lessons learned, may not be as obvious. Lessons learned are important because our design and manufacturing tools are imperfect and experience is a valuable resource. As already stated, despite our best efforts to design properly and to validate the design through development testing, products are seldom perfect. They are imperfect because our knowledge and tools (models, analytical techniques, manufacturing processes) are imperfect. Field performance can be monitored and the Lessons learned from that monitoring can be used to refine our knowledge and tools. One way to capture the knowledge represented by lessons learned is to capture them in design guidelines, such as those documented in Appendix C.

As noted in 2.2.2, demilitarization and disposal (or in commercial terms, retirement and phaseout) of a product is a part of the life cycle. DoD does not define it as a separate phase, and many companies and customers consider it as the last stage of the O&M phase. As some products near the end of their useful life due to obsolescence or wear-out, the customer or supplier may need to address several critical activities:

- Recovery of precious metals or other valuable, recyclable materials
- Salvage of equipment and components for use in other products
- Safe disposal of hazardous materials
- Logistics support of demilitarization and disposal (retirement and phaseout)

These activities can be made more efficient and economical if they are considered during the design of the product. As noted in 2.2.2.4, the extent to which the maintainability engineer will be involved with designing for demilitarization and disposal can vary from company to company. In most cases, the maintainability engineer, safety engineer, and logistics managers play at least some role in designing for demilitarization and disposal and in carrying out the associated activities.

This page has been left blank intentionally.

SECTION FOUR**4.0 ELEMENTS OF A MAINTAINABILITY PROGRAM.**

No single set of specific tasks and activities defines the "best" maintainability program. Specific tasks and activities must be selected based on the type of product, the technology being used, product development budget and schedule constraints, customer needs, and so forth. Certain general elements, however, are necessary for a sound maintainability program and give direction to the process of selecting specific tasks and activities. These elements are management, design, analysis, test, and data.

A maintainability program may be described by a supplier in a maintainability plan. Such a plan should address the management approach, required resources, interface with related disciplines, the activities constituting the program and a schedule showing when activities must occur. Within the Government, prior to Defense Acquisition Reform (DAR), it was customary to require suppliers responding to a solicitation to include a maintainability program plan as part of their proposals. Although not specifically addressed in DAR policy issued by DoD, some procurement commands within the military services have now prohibited such a requirement. Of course, suppliers are always free to include such a plan if they determine it to be the best way of responding to the solicitation. Appendix A provides guidance in developing the maintainability portion of solicitations and in evaluating responses. No single model or standard plan is cited in this handbook because the plan should reflect the unique requirements of the acquisition program, the technology being used in the product, the amount of new development versus commercial off-the-shelf (COTS) or a non-developmental item (NDI), and many other factors. The elements described in this section, however, should be addressed in any and all maintainability plans.

4.1 Overview. A sound maintainability program begins with good management. It is management that assigns and allocates resources, directs and controls processes, and evaluates progress. So a maintainable product begins with a deliberate decision by management to make the product maintainable. Since maintainability is a true design characteristic, it must be a design requirement leading to certain design approaches and features. To support designing for maintainability, certain analyses must be conducted. Some of these analyses may be unique to maintainability while others are also performed for other purposes. Design, especially for products incorporating new technologies or having complex functions, must be supplemented by effective development test. Finally, data are needed to support maintainability design and analysis, and data from the maintainability effort are needed in other functional areas, especially logistics planning.

4.2 Management Approach. Management has five basic responsibilities regarding a maintainability program: assign responsibility for maintainability, provide adequate resources to implement the maintainability program, establish and maintain good lines of communication within the company and with the customer, integrate the maintainability program into the overall product development effort, and establish controls for subcontractors and vendors.

Depending on the specific product development effort and on customer requirements, suppliers may document how these responsibilities will be met in a maintainability plan. The plan may be quite extensive and detailed or very simple and general, again depending on the product. It may be a "stand-alone" plan or a part of other plans (a reliability and maintainability program plan, for example).

4.2.1 Clear Responsibility. An individual must be given the formal responsibility for implementing the maintainability program. As noted in 1.1, the title of this individual varies as does his or her organizational assignment. Regardless of title or organizational placement, it is essential that the individual have the appropriate knowledge and experience and be an integral part of the design effort.

4.2.2 Adequate Resources (Quantity and Quality). Whoever is assigned the responsibility for maintainability must also have the resources needed to do the job. These resources can include analytical tools, test items and facilities, computers and software, labor hours, and reference documents. The level of funding available for these resources should be appropriate for the type of product, level of technical risk, and customer needs.

4.2.3 Lines of Communication. Accurate and timely communication is critical in today's design and manufacturing environment. For products such as automobiles, aircraft, missiles, and similarly complex items, many individuals and specialties are involved in the development effort. Some may be geographically separated from others. Without good communications among these people and with the customer, requirements can be overlooked. Communications are enhanced through the use of computer-aided design and manufacturing (CAD/CAM) and the use of common data bases.

4.2.4 Integration with Related Functions. As was discussed in 2.2 and 2.3, maintainability is affected by many other related functions, such as manufacturing, human engineering, and so forth. Maintainability, in turn, affects these and other functions. The interrelationships among maintainability and other functions make it essential to develop a maintainability program that is integrated with the overall product development program. The benefits of an integrated program is the maximum use of data from each analysis and test, the elimination of duplicative efforts, and a focus on overall product performance rather than on optimizing any one characteristic.

4.2.5 Subcontractor and Vendor Control. A strong maintainability program will reflect an integrated team approach to the development of a product. Although the prime contractor has the responsibility for the product's performance, each subcontractor and vendor is an important member of the product development team. Accordingly, appropriate requirements and guidance must be provided to all subcontractors and vendors. These requirements and guidance should, if at all possible, be developed with the suppliers to encourage an exchange of ideas, foster a thorough understanding of program objectives and the role of supplier in meeting those objectives, and to promote the integrated team concept.

4.2.6 Reviews. A series of design reviews are necessary during a program to control risk, ensure a balanced design is evolving, evaluate progress, and to anticipate and avoid problems. These reviews vary in purpose and can vary in the manner in which they are conducted. Some typical types of reviews are shown in Table VI. All of these reviews may not be necessary for some products. Other products may require additional reviews. For some very complex products, a review dedicated only to maintainability, or often to reliability and maintainability, may be required. A key indicator of how well maintainability is being considered is whether it is one of the requirements or characteristics included in all of these reviews. It should be clear that maintainability is a "player" in tradeoffs and is being considered in the design. Clear signs that maintainability is a dynamic element of the design are that the maintainability engineer or manager has sign-off authority of design drawings and is required to participate in tradeoffs.

TABLE VI. Types and Purposes of Design Reviews

Review Title	Purpose	Key Maintainability Questions
Product Requirement Review	Review the product requirements and specifications to ensure they are clear, accurate, verifiable, and reflect the operational needs of the customer. A separate Software Specifications Review may be conducted to concentrate only on software requirements.	Are performance-based maintainability design requirements included? Are they derived from operational requirements?
Product Design Review	Review the high-level product design and architecture, partitioning, and requirements allocations.	Are maintainability requirements allocated? Are the allocated requirements realistic?
Preliminary Design Review	Review hardware and software designs for functional flow, requirements allocations, thermal, power, packaging, reliability, maintainability, manufacturability, and other performance characteristics. Identify potential problems and develop solutions.	What trades have been made to improve maintainability? Where are the major maintainability problems?
Critical Design Review	Similar to Preliminary Design Review but the purpose in reviewing the designs is to evaluate their readiness for release to manufacturing.	Are there outstanding maintainability problems? Do predictions indicate that the required product maintainability will be achieved?
Production Readiness Review	Review design of manufacturing processes, tools, fixtures, and so forth to determine readiness of the production facility to manufacture the product.	Have any problems arisen in which manufacturing considerations affect maintainability?

4.3 Design for Maintainability. Design determines a product's inherent capabilities. Whether it is the power handling capacity of a circuit, the frequency of a signal, or the minimum time required to replace a part, a capability must be designed into a product.

4.3.1 Specific Considerations. Detailed and quantitative studies of maintainability were not initiated until the early 1950's. Before 1950, maintainability was often viewed as a "common sense" ingredient of design. However, other performance requirements and acquisition budget concerns frequently overrode design decisions made to improve maintainability. Now, the ownership costs and availability requirements of increasingly complex modern systems and equipment demand that designing for maintainability be as important as designing for other performance characteristics. The maintainability engineer must now ensure that considerations

for maintainable designs are an integral element of every design trade study or design change activity.

The basic objectives of designing for maintainability are to meet the operational readiness requirements for the product and to reduce support costs. A maintainability engineer committed to these objectives will continually challenge the design to uncover weaknesses and potential maintenance problems. The objective is to design in maintainability. If this objective is not met and the production hardware fails to meet maintainability objectives, corrective design changes will have to be made later in the equipment's life cycle at significant expense. The primary emphasis of the maintainability program is to identify and correct maintainability problems early in the design process when correction simply requires changing drawings.

4.3.1.1 Support Concept. Support concepts are the methods, including the maintenance concept, by which the customer intends to maintain the product and can be as varied as the design itself. Support concepts range from discard at failure to a complete overhaul at failure. They may include periodic or scheduled maintenance or overhaul. They can include maintenance performed by the customer, the supplier, a third party, or some combination of the three. Within the military services, three levels of maintenance are normally defined: organizational (on-site), intermediate (local shops), and depot (an overhaul facility). (No one definition of maintenance levels could be found for all commercial industry. However, perhaps defined somewhat differently or combined in some way, the following levels of maintenance are considered representative of those used by commercial industry). Maintenance performed at these levels keeps the product serviceable or restores it to an operational condition after a failure. A brief description of each level of maintenance follows.

Organizational Level of Maintenance. Organizational maintenance is performed at the operational or product site. Maintenance at this level normally is limited to periodic performance checks, visual inspections, cleaning, limited servicing, adjustments, and removal and replacement of some components (i.e., constituent module, part, item, etc. of the product). Repair of removed components is normally not made at this level (but see 4.4.1.6.2). Instead, the failed component is replaced with a spare. The removed component is then sent to the next level of maintenance (usually intermediate) for repair. Diagnostics, accessibility and ease of removal and replacement are very important at the organizational level and should be key design considerations. This level of maintenance has the primary goals of keeping the product in a serviceable condition and rapidly restoring the product to an operable condition after failure using low to moderately skilled personnel.

Intermediate Level. Intermediate level maintenance is normally performed at a "shop location" and may be performed on the product or a repairable component of the product. At this level, products might be repaired by removal and replacement of parts or modules, or the parts or modules of a product might be repaired. The skill level of personnel at this level is usually higher than at the organizational level of maintenance. Intermediate level of repair

facilities may also be tasked with doing limited depot/overhaul level repairs. These type of repairs are typically based upon technical knowledge, facilities and potential cost savings.

Depot Level. Depot is the highest level of maintenance. The depot is a specialized repair facility that may very well be structured like an assembly line. It may be a customer-operated repair facility or the original equipment manufacturer's plant. Maintenance includes rebuilding or overhauling a product and may be performed on a specific lot of failed equipment that has been screened for similarity in failure type. The most highly skilled and trained technical personnel are assigned to depots. Test equipment is very complex, technical publications are more detailed, and manufacturing source data are frequently available. One specific depot might be structured to support all forms of communication radios or all types of pumps.

Maintenance can include two basic types of tasks. The first, called preventive maintenance (PM), is usually performed at the organizational level. PM retains a product in serviceable condition by inspections, servicing and other preventive measures performed on a calendar, cyclical, or on-condition basis. The second is corrective maintenance (CM). CM is performed to return a product to operation after a failure and may be accomplished at the operational, intermediate, or depot level. The cost of maintenance, preventive or corrective, is directly determined by the maintainability of the design.

A support concept is more than simply identifying whether PM and CM are required and whether maintenance will be performed at one, two, or three levels of organization. It means deciding on a run-to-failure or on-condition maintenance approach (see 4.3.1.3). It also addresses whether support will be provided by the customer, by the product manufacturer, or by both. Often, the military services elect to plan for contractor support at the intermediate and depot levels until a product has been proven in actual use. Then responsibility for the maintenance may be transitioned to the military service. Such a strategy is called interim contractor support. Finally, a support concept can involve centralizing some organizational and intermediate level maintenance at one or two sites.

The approach to handling ambiguity groups is also a part of the support concept. Sometimes, factors make fault isolation to a single replaceable unit or item impossible to achieve. These factors include the complexity that would be added by fault isolating to a single item, the total cost associated with fault isolating to a single item compared with the cost associated with fault isolating to two or more items, and the type of technology being used. Consequently, some failures will be detected by the integrated diagnostics and isolated to two or more items. To correct the failure, one of two basic approaches may be used. For relatively small ambiguity groups, the entire group will be replaced. For larger groups, items in the group will be iteratively replaced until the failure is corrected. The decision to use group or iterative replacement is primarily based on economics and the effect on predicted total downtime.

The support concept should be tailored to the type of product in question. That is, the product may be a new development, a non-developmental item, or a commercial off-the-shelf (COTS)

item. In the first case, planners have a good deal of latitude in selecting the concept, since the designers can respond to the chosen concept as they design the product. For non-developmental items, less latitude is available. Finally, for COTS, little flexibility in choosing a support concept is left to the planners. It is unlikely that the engineering, design, and other detailed data needed to develop an organic repair capability will be available. Also, configuration control below the product level will most likely be maintained by the supplier, not the customer. So in many cases, support for COTS will consist only of removal and replacement at the operational level with depot and even intermediate maintenance performed by the depot.

For new development products, the support concept can and should greatly influence the design for maintainability. For example, ease of disassembly is not a concern for non-repairable products that are thrown away after failure. But if the product is a component or subsystem of a larger product, accessibility to facilitate removal and replacement is important. Also, the design approach for a product can be very different depending on whether the customer or the contractor will be providing the support.

4.3.1.2 Operational and Support Environment. It is essential that the supplier understands the environment in which the customer will operate and maintain the product. Environmental factors, such as temperature and humidity, limit the way in which personnel can perform required maintenance. For example, when products must be maintained in very cold climates or under hazardous conditions (radioactive, biological or chemical environments), personnel will be wearing heavy clothing and gloves. Such clothing restricts movement, requires more room for access, and reduces dexterity. In addition, materials can shrink or expand making connection and disconnection of mating parts difficult. In hot climates with high humidity, perspiration can impair vision and affect a person's grip. If maintenance must be performed outside, the maintainability engineer must try to design access panels so that rain cannot penetrate into the interior of a product. For some products, it might be necessary to perform maintenance while the product is operating. In such cases, the maintainability engineer's primary concern is to design the product and procedures to minimize the hazards involved with maintenance.

In addition to analytical techniques, the maintainability engineer has two excellent methods of characterizing the support environment. First, the customer's maintenance personnel can be brought in to participate in the design process at the earliest phase of product development. Second, maintainability and design engineers can visit the customer's operating sites to gain first-hand knowledge of the operational and support environment. Every product needs to be assessed for the environmental impact on maintainability.

4.3.1.3 Preventive Versus Corrective Maintenance Requirements. Preventive maintenance (PM) is usually self imposed downtime (although it may be possible to perform some PM while the product is operating). PM consists of actions intended to prolong the operational life of the equipment and keep the product safe to operate. Ideally, a product will require no servicing or other preventive maintenance and either the probability of failure is remote or redundancy makes failure acceptable (however, one often-required PM task is to verify the operational status of

redundant components prior to a mission.). For such an ideal product, only corrective maintenance, if any, would be required. Most often, however, failure is not a remote possibility. Moreover, most products of any complexity require some servicing, even if that only consists of cleaning. Sometimes failures can actually be prevented by preventive maintenance. The goal, then, is to identify only that preventive maintenance that is absolutely necessary and cost-effective. Figure 5 illustrates the two major categories of maintenance, PM and CM, and the tasks associated with each.

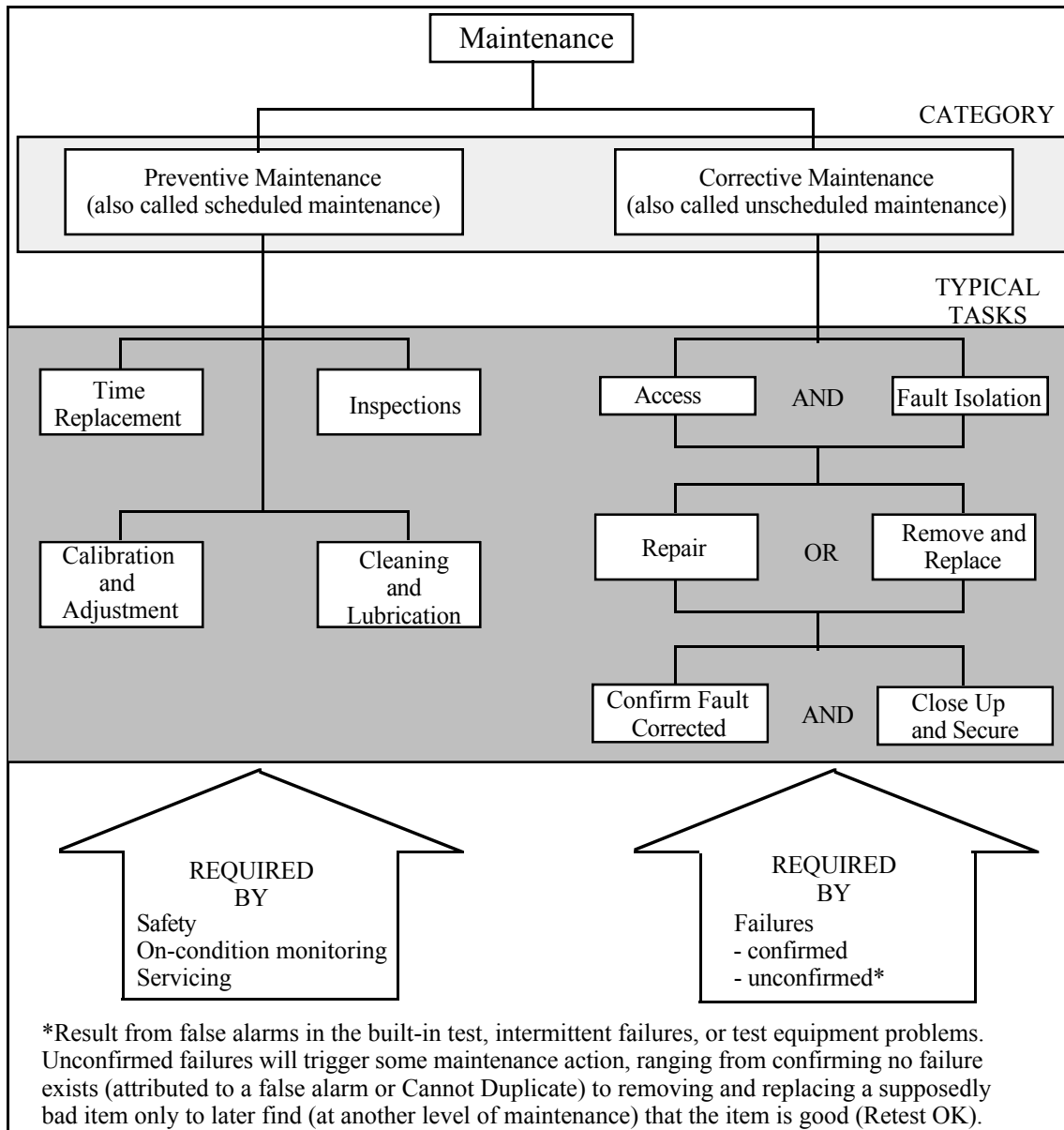

FIGURE 5. Major Categories of Maintenance.

Reliability Centered Maintenance (RCM) is an analytical method used to identify essential and cost effective preventive maintenance. Preventive maintenance for a product may be scheduled

based on condition, a number of events, rounds fired, cycles of operation, seasonal time period, operational profile changes, and sometimes as the result of failures of other equipment. For example, automobile manufacturers provide buyers with a range of recommended mileage-based and time-based preventive maintenance. The initial overall maintenance program should reflect the RCM-based schedule for preventive maintenance. Figure 6 summarizes the steps in an RCM approach to identifying preventive maintenance.

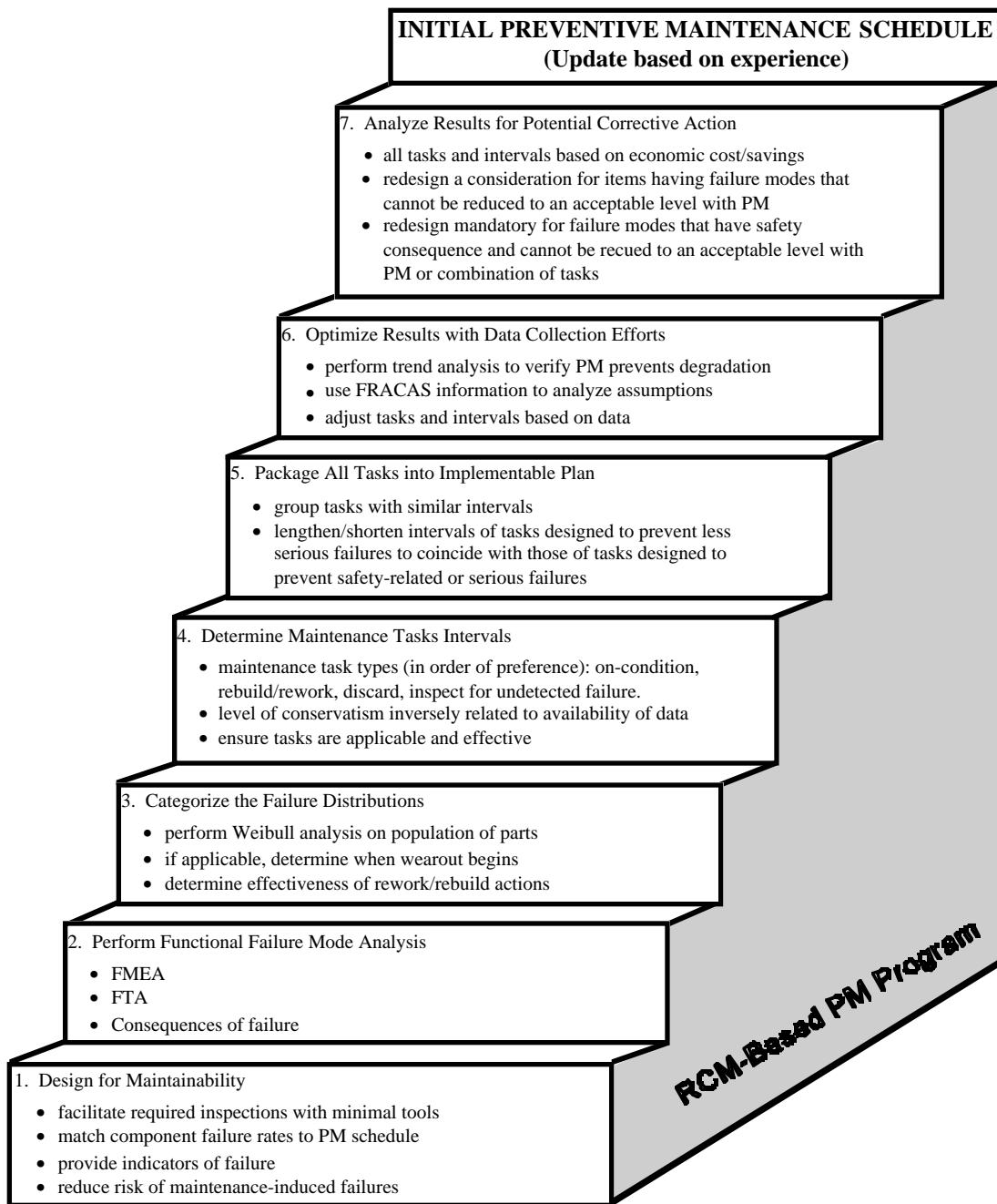

FIGURE 6. The Steps in an RCM Approach to Identifying Preventive Maintenance.

Reference has been made to "on-condition" and "based on condition" in determining the frequency or need for PM. On-condition monitoring, also called predictive maintenance or performance monitoring, is a process whereby one or more parameters are unobtrusively monitored and trended over time. These parameters must have a direct relationship with the "health" of the equipment being monitored. On the basis of some threshold value (determined through analysis or experience) of a parameter or combination of parameters, the equipment will be repaired or replaced prior to any actual failure. This approach to "scheduling" PM can significantly reduce costs, prevent failures, and increase safety. The approach has long been used to "detect" an impending problem in rotating machinery by monitoring vibration.

Improvements in sensors and recording devices and an understanding of which parameters truly indicate health have increased the number of applications of condition monitoring. One device developed under Air Force sponsorship, the Time Stress Measurement Device (TSMD), is one example of a technological improvement related to on-condition monitoring. The TSMD collects, records, and stores stress data for subsequent analysis. Although initially studied as a method of dealing with false alarms (see 4.3.1.7), TSMDs can be used with appropriate sensors to record health-related parameters. The recorded levels of the parameters can then be compared with pre-established limits. When the limits have been exceeded or the data indicates that the limits will be exceeded in the near future, an inspection would normally be performed to confirm that a failure is imminent. If the inspection confirms the analysis, then appropriate maintenance can be performed before an actual failure occurs. If the inspection shows that no problem exists, it may be necessary to revise the pre-established limits.

Corrective maintenance includes those activities required to return failed equipment to acceptable operational status. Corrective maintenance consists of recognizing that a failure has occurred (fault detection - FD), determining what has failed (fault isolation - FI), accessing and replacing or repairing the failed component, and confirming that the failure has been corrected. It is the maintainability engineer's responsibility to strike the best balance between preventive and corrective maintenance, keeping in mind such factors as safety, availability requirements, and the customer's operating and support concepts.

4.3.1.4 Human Engineering (HE). During design, the HE engineer has two roles. In one role, the HE engineer represents the potential user, operator, and maintainer and is concerned with ease of operation, safety, comfort, work loads, and so forth. In the other role, the HE engineer evaluates people as "components" and their contribution to product effectiveness. The HE engineer is concerned with many design issues including:

- Safety of operators and maintainers
- Which functions to allocate to humans
- How best to present information to the user, operator, or maintainer
- Accessibility
- The design of tools

- The design of controls
- Anthropometry
- Required skill levels

Military standard 1472, MIL-HDBK-759, and MIL-HDBK-338 provide detailed information and data on HE. In addition, Appendix C includes design guidance related to HE.

4.3.1.4.1 Presentation of Information. Although information is usually presented through visual displays and through auditory signals, other methods include touch, smell, the sense of balance (vestibular sense), or sensations of position and movement (kinesthesia). Each of these methods has its own variables. Visual displays, for example, can be in color or black and white, use symbols or text, use moving scales with fixed indicators or fixed scales with moving indicators, and so forth. To select the best method requires an understanding of the way in which humans process, interpret, and store information; the detection and differential sensitivity of the human senses; and human psychology and physiology. Figure 7 illustrates some of the factors involved in the human information processing system.

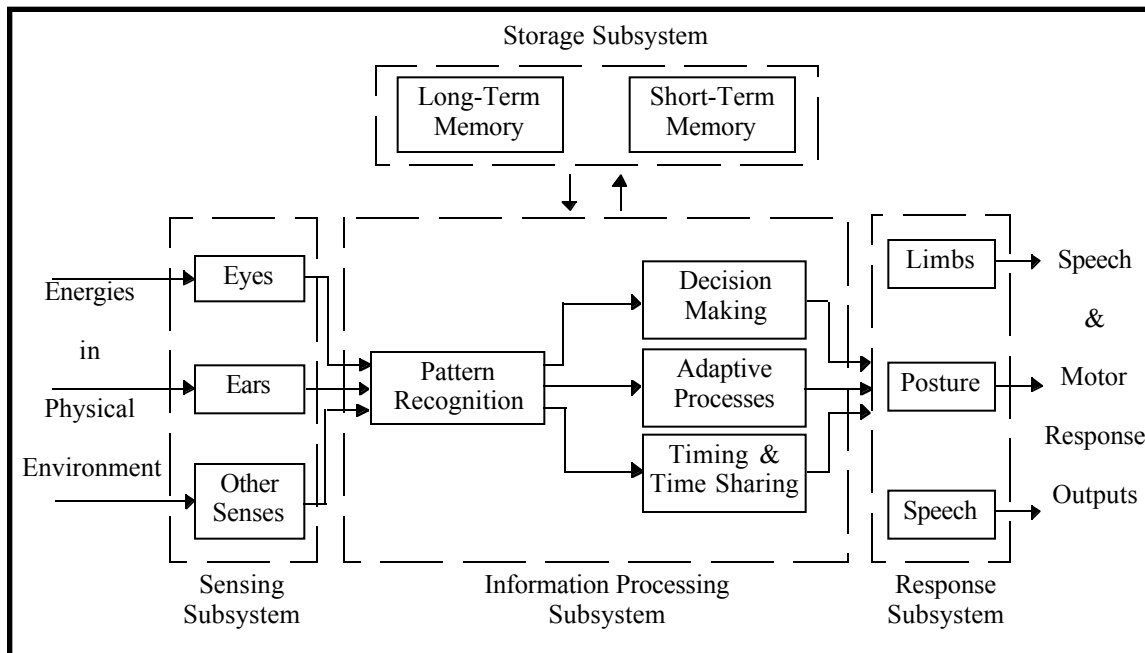

FIGURE 7. The Human Information Processing System.

The maintainability, HE, reliability, safety, and other design engineers must develop a product design that contributes to proper operator responses by creating perceivable and interpretable stimuli requiring reactions within the user's, operator's, or maintainer's capabilities. Feedback ought to be incorporated into the design to verify that operator responses are correct. In other words, product characteristics should serve as both input and feedback stimuli to the operator or maintainer. These interactions between the human and the product are depicted in Figure 8.

4.3.1.5 Maintenance Tools and Support Equipment. Few products can be maintained without using some tools. Maintenance of many consumer products requires only common hand tools, such as screwdrivers and pliers. Maintenance of other products can require test equipment, servicing stands, protective clothing, specialized tools, and so forth. It is the maintainability engineer's responsibility to identify the tools and equipment needed by maintenance personnel to support the product. To keep costs down and reduce the amount of specialized training required, the maintainability engineer will try to use tools and equipment already in use for other products. For example, airlines have a large investment in hand tools, support equipment, and other items with which aircraft are maintained. A commercial aircraft manufacturer who ignores this "in-place" inventory and designs an aircraft requiring all new tools and equipment, will find it difficult to market a new aircraft, no matter how advanced it may be.

4.3.1.6 Maintenance Training. Some training of those people who will be maintaining the product is usually required. The amount of training and the extent to which this training is unique to the product is a function of product complexity, whether the product is totally new or is similar to a previous product, the technology used in the product, and the skill and education levels of the maintenance personnel. As part of the maintainability effort, training requirements for personnel at all levels of maintenance must be identified. Even when training requirements and training development are the responsibility of training specialists, they will require inputs from the maintainability engineer.

4.3.1.7 Testability and Diagnostics. An important component of maintainability is testability, widely defined as a design characteristic that allows the status (operable, inoperable, or degraded) of an item to be determined and the isolation of faults within the item to be performed in a timely and efficient manner. As implied in this definition, it is not enough to make a design "testable". The design must be such that testing is efficient in terms of detecting and isolating only failed items, with no removal of good items. The removal of good items continues to be a problem in many industries, with obvious impacts on troubleshooting times and repair and logistics costs.

Whereas testability is related to the physical design characteristics of a product, diagnostics are related to the means by which faults are detected and isolated. This includes the actual tests themselves, as well as the means by which tests are performed. Achieving good diagnostics involves determining the diagnostic capability required in a product. A diagnostic capability can be defined as all capabilities associated with the detection, isolation, and reporting of faults, including testing, technical information, personnel, and training. In comparing testability with diagnostics, we see that testability is an inherent design characteristic, while diagnostics involves factors other than those associated with the design itself. Attention paid to both in all design phases will impact not only the cost of producing a product, but certainly the cost of maintaining the product once it has been fielded.

Finally, planning for BIT at all levels within the system design is becoming more important for a number of reasons. First, surface mount devices (SMDs) are increasingly being used in the design of circuit cards. The use of SMDs, and devices with higher packaging density (including double-

sided boards), decreases the accessibility required for guided-probe testing, while increasing the risks of such testing. Incorporating BIT in such designs therefore becomes critical to effective diagnostics. Second, many component vendors of integrated circuits (ICs), such as Application Specific ICs (ASICs) are incorporating some form of BIT into their designs. Higher-level designs (i.e., board, module, etc.) that use such devices must take advantage of this fact by planning to integrate lower-level BIT capabilities with higher-level BIT designs. Doing this will increase the vertical testability of an entire system, wherein factory-level test programs can be used in field operations as well as the factory. Further, tests performed using BIT at higher levels of support (e.g., depot or intermediate) can also be used at lower levels (i.e., intermediate and organizational). This characteristic of the diagnostic system will help to maintain consistency across maintenance levels and may reduce the high incidences of Retests OK (RTOK) or Can Not Duplicates (CNDs).

The most important factor in BIT design is early planning. Without planning for BIT early in the life cycle, it will be harder to maximize any advantages offered by the use of BIT while minimizing any negative impacts such as increased design cost, higher hardware overhead, and increased failure rate. In "Chip-To-System Testability" (Interim Report submitted to Rome Laboratory under Contract No. F30602-94-C0053, 1996, Research Triangle Institute and Self-Test Services), five axioms are given that will allow designers to capitalize on the use of BIT. These axioms are:

- Plan for BIT starting at the earliest stage (e.g., proposal stage) of the program
- Design BIT in conjunction with the functional design, not as an afterthought
- Use the same high degree of engineering cleverness and rigor for BIT that is used for the functional design
- Take advantage of computer aided design (CAD) tools for the BIT design process whenever possible
- Incorporate the subject of BIT into peer, design and program reviews

4.3.1.7.1 Testability Design. Although a subset of maintainability, testability has become recognized as a separate design discipline in its own right. Because of the impact on production and maintenance costs of poor testability, it will continue to be treated as a distinct discipline, at least in the foreseeable future. Therefore, it is important to develop a testability program plan as an integral part of the systems engineering process, and to elevate testability to the same level of importance accorded to other product assurance disciplines. Plans must be established that define the need to analyze a design to assure it contains characteristics that allow efficient and effective fault detection and isolation.

Ensuring that a product is testable requires adherence to some basic testability design principles. A list of the most common testability design principles follows, along with a brief description of each.

- Physical and functional partitioning - The ease or difficulty of fault isolation depends to a large extent upon the size and complexity of the units that are replaceable.

Partitioning the design such that components are grouped by function (i.e., each function is implemented on a single replaceable unit), or by technology (e.g., analog, digital) whenever possible will enhance the ability to isolate failures.

- Electrical partitioning - Whenever possible, a block of circuitry being tested should be isolated from circuitry not being tested via blocking gates, tristate devices, relays, etc.
- Initialization - The design should allow an item to be initialized to a known state so it will respond in a consistent manner for multiple testing of a given failure.
- Controllability - The design should allow external control of internal component operation for the purpose of fault detection and isolation. Special attention should be given to independent control of clock signals, the ability to control and break up feedback loops, and tri-stating components for isolation.
- Observability - Sufficient access to test points, data paths and internal circuitry should be provided to allow the test system (machine or human) to gather sufficient signature data for fault detection and isolation.
- Test System Compatibility - Each item to be tested should be designed to be electrically and mechanically compatible with selected or available test equipment to eliminate or reduce the need for a large number of interface device (ID) designs.

In addition to the preceding principles, checklists of testability design practices have been developed that are specific to technologies, such as analog, digital, mechanical, and so forth. A detailed checklist can be found in Appendix C.

Determining the amount of testability necessary in a design will be driven by the requirements for fault detection and fault isolation. Fault detection requirements are typically stated as the percentage of faults that can be detected, using defined means (BIT, semi-automatic/automatic test, etc.), out of all possible faults. For instance, a system may have a requirement of 95% fault detection, indicating that 95% of all possible failures are to be detectable by the diagnostic capability of the system. Fault isolation requirements are typically stated as the percentage of time fault isolation is possible to a specified number of components. As an example, a system may have a requirement of 90% isolation to a single replaceable unit (RU), 95% isolation to an ambiguity group of 2 or fewer RUs and 100% isolation to an ambiguity group of 3 or fewer RUs.

Mathematically, fault detection and isolation are defined in the following equations for the fraction of faults detectable (FFD) and the fraction of faults isolatable (FFI).

$$\text{FFD} = \text{FD}/\text{FA} \quad \text{where FA} = \text{total number of actual faults occurring over time and FD} = \text{no. of actual failures correctly identified using defined means.}$$

To calculate predicted fault resolution using equation 4, data are required that correlate each detected failure with the signature, or "error syndrome", that each failure produces during testing. The data are most conveniently ordered by signature and by failed module within each signature. The signature, then, is the observed test response when a particular failure occurs. This information typically is generated from an FMEA, or in the case of electronics design, especially

digital, from a fault simulation program. The collection of test responses, or failure signatures, represents a fault dictionary. In many instances, several failures will produce the same observed (usually at the system output(s)) signature, creating ambiguity. The fault resolution predicted by equation 4 measures the amount of ambiguity that exists, for a given level of test capability. As noted, for each signature, a list of suspect modules is created, providing the input data needed to apply equation 4. Equation 4 includes a signature index, i , which is arbitrarily chosen (e.g., all signatures can be numbered from 1 to n). The modules within a signature can also be numbered, representing j in equation 4, or the module index within a signature.

$$FFI_L = \left(\frac{100}{\lambda_d} \right) \sum_{i=1}^N X_i \sum_{j=1}^{M_i} \lambda_{ij} \quad (\text{Equation 4})$$

where:

$$\begin{aligned} X_i &= 1 \text{ if } M_i \leq L; 0 \text{ otherwise} \\ N &= \text{number of unique test responses} \\ L &= \text{number of modules isolated to (i.e., ambiguity group size)} \\ i &= \text{signature index} \\ M_i &= \text{number of modules listed in signature } i \\ j &= \text{module index within signature} \\ \lambda_{ij} &= \text{failure rate for } j\text{th module for failures having signature } i \\ \lambda_d &= \text{overall failure rate of detected failures} = \sum_{i=1}^N \sum_{j=1}^{M_i} \lambda_{ij} \end{aligned}$$

Additional quantitative measures of testability may include fault isolation time, which is derived from the Mean Time To Repair (MTTR).

$$\text{Mean Fault isolation time} = \text{Mean} [\text{repair time} - (\text{operation time} + \text{disassembly time} + \text{interchange time} + \text{reassembly time} + \text{alignment time} + \text{verification time})]$$

Note that the first two measures are interrelated in that before you can isolate a fault, you must first detect it. Therefore, a testability analysis program is designed to analyze the effectiveness of the detection scheme, and then to analyze the effectiveness of the isolation scheme. For complex designs, the analysis of testability often requires the use of testability design and analysis tools that provide information on fault detection and isolation, for a given diagnostic approach, or diagnostic capability.

False alarms (in which a failure is "detected" even though none occurred) is a problem related to both testability and a system's diagnostic design. Manifesting themselves in varying degrees in avionics and other types of equipment, false alarms are a drain on maintenance resources and reduce a system's mission readiness. The two most commonly reported symptoms of false alarms are CND and RTOK.

False alarms occur for many and varied reasons, including external environmental factors (temperature, humidity, vibration, etc.), design of diagnostics, equipment degradation due to age,

design tolerance factors, maintenance induced factors (e.g., connectors, wire handling, etc.), or combinations of these factors. External environmental factors may cause failure of avionics or other equipment that do not occur under ambient conditions and are believed to be a leading cause of false alarms. When the environmental condition are removed, the "failure" cannot be found. One solution to the problem is to use a stress measurement device to record the environmental stresses before, during, and after a system anomaly. Subsequent diagnosis can use this data to determine what occurred and whether any action (maintenance, modifications, etc.) are needed.

As discussed in 4.3.1.3, a stress measurement device that has been studied over the past few years by the Air Force is the TSMD. TSMDs focus on the measurement, collection, storage, and subsequent failure correlation analysis of the recorded stress data. The TSMD records an image of all of the environmental data prior to, during, and after a system anomaly. The recorded event, called a fault signature, identifies any environmental stress-related conditions that may be causing intermittent or hard failures. The TSMD data aids in reducing RTOK, and CND conditions by correlating the event with the conditions that existed when the anomaly was detected.

Several different models of TSMDs have been developed by different manufacturers. They feature both 8 bit⁸ and 32 bit⁹ internal microprocessors and RS-232 and RS-485 interfaces. Typically they are powered by 5 volts DC drawn from the host system and dissipate 1 watt or less. They also have the capability to accept power from an external battery for operation under power-off conditions, e.g., shipping and/or storage.

Many commercial stress measurement devices are also in use or under study. A RAC publication¹⁰ provides a compendium of currently available commercial stress measurement devices, including their sensing and storing capabilities. This publication is part of an on-going market survey aimed at identifying sources of stand-alone environmental stress data collection systems.

4.3.1.7.2 Diagnostic Capability. Defining and developing a product's diagnostic capability depends on a number of factors such as:

- The product's performance and usage requirements
- Maintenance support requirements (e.g., levels of maintenance)
- Technology available to: improve diagnostics in terms of test effectiveness; reduce the need for test equipment, test manuals, personnel, training, and skill levels; and reduce cost
- The amount of testability designed into the product
- Previously known diagnostic problems on similar systems.

⁸ Skeberdis, P. W., White, E. G., Westinghouse Electronics Systems, Fault Logging Using a Micro Time Stress Measurement Device, RL-TR-95-289, January 1996

⁹ Havey, G., Louis, S., Buska, S., Honeywell Inc., Micro-Time Stress Measurement Device Development, RL-TR-94-196, November 1994

¹⁰ Environmental Characterization Device Sourcebook (ECDS), Reliability Analysis Center, P.O. Box 4700, Rome, NY 13442-4700, 1 (800) 526-4802

Each of these factors will play a role in determining the approach to detecting and isolating faults. A typical approach to diagnostics includes the use of BIT. BIT is a design response to the need to reduce maintenance manpower and external test equipment. Other approaches may consider the use of automatic or semi-automatic test equipment, manual testing using benchtop test equipment, or visual inspection procedures. In all cases, tradeoffs are required among system performance, cost, and test effectiveness.

It is important to remember that the effectiveness of the diagnostic capability, and the cost of development, is greatly influenced by the amount of testability that has been designed into the system. Should there be a lack of test points available to external test equipment, for example, then the ability to isolate failures to smaller ambiguity group sizes may be adversely affected. The result is higher costs to locate the failure to a single replaceable item. The cost of test development may also increase. BIT design should be supported by the results of a failure modes and effects analysis (FMEA). An FMEA (see 4.4.1.3.3) should be used to define those failures that are critical to system performance, and to identify when the effects of a failure can be detected using BIT. Without such information, BIT tests can be developed based only on the test engineer's knowledge of how the system works, and not on whether a test needs to be developed for a particular fault. Finally BIT must be a part of the product design or the risks and consequences shown in Table VII can ensue. Further information on BIT design can be found in Appendix C.

TABLE VII. Risks and Consequences of Not Making BIT Part of Product Design.

Risks	Consequences
BIT is designed independently of the product	BIT fails to support operational and maintenance needs
BIT is designed after the fact	BIT's MTBF is less than that of the product
Production personnel are not consulted on BIT	BIT is not effective in the factory

4.3.1.8 Interfaces and Connections. One area of design that poses problems for both the reliability and maintainability engineer is that of interfaces and connections. Interfaces and connections, of course, make it possible to remove or perform maintenance on individual items. In disconnecting and reconnecting items, failures can be induced by mis-mating parts, cross threading connectors, damaging interface devices, and so forth. Disconnecting and reconnecting items accounts for much of the time needed to remove and replace items. In the case of high voltage electrical or high-pressure hydraulic and pneumatic connections, injury can result if proper precautions are not taken. The possibility of damage or injury, and the time associated with connecting and disconnecting items can be minimized through proper design for maintainability. Examples of such design are:

- Items that can be connected and reconnected without special tools
- Simple connections with few moving parts
- Use of quick disconnects (self-sealing) in hydraulic/pneumatic systems
- Adequate space allowed to make connections and disconnections
- Items with safety interlocks

Appendix D illustrates many of the types of mechanical and electrical connections used in modern products. Appendix C includes detailed design guidelines for product interfaces and connections.

4.3.1.9 Safety and Induced Failures. As indicated in 4.3.1.8, connecting and disconnecting items within a product can pose safety risks or result in induced failures. As implied by the name, an induced failure is one caused by human error or misuse. Unsafe conditions also can result from human error and misuse. Mislabeling or lack of labeling, poorly written instructions, omission of warnings, inappropriate choices of displays and controls, and so forth can also lead to damaged or failed equipment, and to injury or death of operators or maintainers.

Some of the reasons that induced failures or unsafe conditions occur are:

- Operating or maintenance instructions or procedures are unclear or can be misinterpreted
- Warning labels are not properly placed or warnings in procedures not in correct sequence
- Items not functionally interchangeable are physically interchangeable
- Blind matings do not have self-guiding features
- High failure items require low-failure items to be removed to facilitate maintenance (unnecessarily increasing the removal rate for the latter)
- The operation of controls is contrary to intuition or common practice (i.e., a knob is turned counter-clockwise to increase power)
- Informational displays are difficult to read or interpret
- Tasks are physically awkward to perform

Appendix C has many design guidelines intended to avoid unsafe situations and to reduce the possibility of induced failures.

4.3.1.10 Standardization and Interchangeability. Standardization and interchangeability are important, interrelated, maintainability design factors. Interchangeability is one of the principal means by which standardization is achieved. Good examples of the close standardization/interchangeability relationship are the standard size base for incandescent lamps and the standard size male plug for electrical appliances.

This section stresses the economies of designing toward standardizing hardware and software with that of existing customer products, or within the product under design.

4.3.1.10.1 Standardization Design Goals and Principles. *Standardization is a design feature for restricting to a minimum the feasible variety of items which will meet the hardware requirements. Standardization includes not only parts but also: engineering terms, principles, practices, materials, processes, software, etc.*

Standardization encourages the use of common items. It is important that maintainability engineers strive for the design of assemblies and components that are physically *and* functionally interchangeable with other like assemblies and components of the system. Standardization design will reduce the need for expensive support facilities at all levels of maintenance.

Standardization, a major objective of maintainability, translates into achieving the following goals:

- Minimizing both the acquisition and support costs of a system
- Increasing the availability of mission-essential items
- Reducing training requirements both in number of personnel and the level of skill required
- Reducing inventories of repair parts and their associated documentation.

To achieve standardization, the following design principles must be carefully considered:

- Make maximum use of all common parts and assemblies
- Reduce to a minimum the variety of assemblies and parts required, and, in doing so, make certain that these basic types are: used consistently for each application and that they are compatible with existing uses and practices
- Reduce to a minimum, by careful study of the simplification thus attained, the problems of supply, storage, and stocking
- Simplify practices, by the same means, in the coding and numbering of parts
- Make maximum use of "off-the-shelf" components, tools, software and test equipment

Despite the advantages offered by standardization, a system should not necessarily be built around a standard item - particularly if the standard item does not meet the required performance, has a record of poor reliability or costly maintenance; or the standard item may satisfy a safety requirement in most environments but not in the unusual environment for which it is being considered. Technological advances may also dictate the development of new material or provide a superior product to replace an existing one.

4.3.1.10.2 Interchangeability Design Goals and Principles. *Interchangeability is the ability to exchange parts or assemblies between like equipments, without having to alter or physically change the item. This is an extremely important life-cycle cost design requirement.*

Total interchangeability exists when two or more items are physically *and* functionally interchangeable in all possible applications - i.e., when the items are capable of full, mutual substitution in all directions. *Functional* interchangeability is attained when an item, regardless of its physical specifications, can perform the specific functions of another item. *Physical*

interchangeability exists when two or more parts or units made to the same specification can be mounted, connected and used effectively in the same position in an assembly or system.

The two broad classes of interchangeability are:

- Universal interchangeable - Items that are required to be interchangeable in the field even though manufactured by different facilities.
- Local interchangeable - Items that are interchangeable with other components made by the same facility but not necessarily interchangeable with those made by other facilities. This may result from different sets of measurement units employed in their design and manufacture.

To attain maximum interchangeability, the following design principles should be applied:

- Functional interchangeability of parts and units should exist wherever physical interchangeability exists - to avoid any potentially dangerous situation
- Physical interchangeability should *not* exist whenever functional interchangeability is not intended
- Whenever total - functional and physical - interchangeability is impractical, the items should be designed for functional interchangeability, and adapters should be provided to make physical interchangeability possible
- To remove latent doubt, sufficient information should be provided in documented instructions and identification plates to enable the technician to decide positively whether or not two similar items are actually interchangeable
- Differences should be avoided, where possible, in the shape, size, mounting, and other physical characteristics of functionally interchangeable items
- Modification of parts and units should not change their manner of mounting, connecting, and otherwise incorporating them into an assembly or system
- Total interchangeability should be provided for all parts and units that:
 - are intended to be identical,
 - are identified as being identical,
 - have the same manufacturer's part number or other identification, and
 - have the same function in different applications (especially important for parts and units that have a high failure rate)
- Parts, fasteners and connectors, lines and cables, etc., should be standardized throughout a system, particularly from unit to unit within a given system
- Mounting holes and brackets should be made to accommodate parts and units made by different facilities - i.e., make them universally interchangeable

4.3.2 Design Tools. To assist in the design of maintainable products, various types of design tools have been developed. These tools can be categorized as analytical, mockups, simulation and virtual reality, handbooks and other reference documents, and expert systems. These categories are discussed in the following sections.

4.3.2.1 Analytical. The majority of analytical tools available today - to assist the designer in designing a maintainable product - are related to modeling the human being. Since the late 1970's more than 50 different human models have been developed. Electronic representations of human forms are used in simulation of equipment assembly, operation, and maintenance during the design process in order to "walk through" these activities in order to identify and resolve human interface problems before hardware is built. Early human models used only hands or arms to check clearances for tool manipulation. Today's models create whole-body representations using a basic "link" system resembling a human skeleton to enable posturing of the model within the work environment.

Although a large variety of human models have emerged to support the design effort, there is little agreement about how the human form should be configured, what constitutes valid data, what are acceptable levels of accuracy, and what software/communications standards should be adopted. Earlier human models focused on the physical or ergonomic aspects of human/machine interaction. The focus today is on integrating this information with visual and cognitive information processing requirements and with human modeling simulation to create an integrated modeling technology. This provides additional realism not only through accurate replication of human anthropometry, biomechanics and movement, but also in simulating purposeful and logical behaviors in response to external stimuli and workload.

The purpose of all of these models is to integrate human performance analysis with Computer-Aided Design (CAD) to provide the design team with a high degree of visualization of human performance capabilities and limitations with respect to the product design. Through integration of graphic human models with CAD product models, "rapid prototyping" of human/product simulations or their results can be passed back to equipment designers for resolution of identified problems.

Designing equipment that is easy to operate, assemble, and maintain is often hindered by poor communications between the design team and personnel familiar with the operation, assembly, or maintenance of similar or existing equipment. Improved communication among integrated product development (IPD) team members can be accomplished by simulating equipment operation, assembly, and maintenance using human modeling technology. Human models combine animated 3-D human mannequin geometry with equipment geometry in order to "walk through" designs so that problems can be solved early in the design process. They help to ensure that human-centered design information is readily and accurately documented and preserved to aid in human resources and related logistics planning requirements for system support. The models are used first to influence a product's design for supportability, and then to document the product requirements for human and logistics resources. Another major objective is the

development and implementation of design evaluation technology for performance of "design checking" and prescriptive human performance information for recommending corrective action to equipment designers to conform to human performance requirements.

The term "human model" in this context refers to the 3-D, computer-graphic representation of a human form for analysis purposes. It does not address human performance models that are independent of the geometric aspects of the human body, e.g., human error models.

Human modeling systems can support both the *design-requirements* definition and *design evaluation* when concepts are only represented in 3-D computerized form. The human design-requirement definition can be accomplished using reach or vision envelopes that describe the minimum conditions a designer must satisfy for physical or visual access. Design evaluations, on the other hand, usually focus on critical task segments in which the human/equipment interface is tested for compliance with stated design requirements and freedom from "won't-fit" or "won't-work" conditions.

Some of the important benefits of using human modeling in CAD are:

- Elimination of most physical-development fixtures by performing evaluations electronically
- Reduction of design costs by enabling the IPD team to prototype more rapidly and test a design among themselves
- Avoidance of costly design fixes later in the program by considering human factors requirements early in the design effort
- Improvement of customer communications at every step of product development by using compelling animated graphics to review and confirm equipment function.

Application of human modeling technology is likely to impact how engineers design, build, and test products in the future. Those who are responsible for manufacturing planning, tool design, or maintenance engineering will be able to communicate with structural and systems engineering effectively to illustrate assembly or maintenance problems associated with new designs. It is expected that human model applications will spread beyond what is traditionally called engineering and be used by various IPD team members from factory-built units to product support groups.

Human modeling software programs are available from a variety of suppliers. Unfortunately, they have created models which are very different: both in functionality and in user interface, and in the underlying data driving the mannequins. This diversity has created not only models that look and behave differently, but also models that produce distressingly different results when performing the same engineering analysis.

For these reasons, the Society of Automotive Engineers (SAE) has formed an ad hoc committee to formulate standards to promote the orderly growth of this technology. The SAE Human Modeling Technology committee has established three major subcommittee activities: user requirements, human model definition, and software standards. A fourth subcommittee activity is being considered on the topic of human performance models that would address human error prediction, human workload, and task time estimation.

4.3.2.2 Mockups. As products became more complex, conceptualizing shape and fit from a two-dimensional drawing became increasingly difficult. As a pre-production version or prototype of the product was constructed, the consequences of inaccurate conceptualization evidenced itself in structural components that would not properly mate, hydraulic lines that did not connect as planned, and so forth. To solve this dilemma, engineers began using mockups of critical sections of the product, sometimes of the entire product. Constructed of inexpensive materials, mockups are non-functioning, dimensionally accurate, and usually full-scale models of the product. Mockups allow the fit and mating of components to be checked before constructing any functional hardware. Although being supplanted by computer-aided design and virtual reality, mockups are still useful tools due to their simplicity and relatively low cost¹¹.

4.3.2.3 Simulation and Virtual Reality. Simulation, as used here, is a method for representing or approximating an object, event, or environment. In this context, simulation can include physical mockups, computer models, or mathematical models. Virtual reality, or VR, is a new technology that has been defined as the total or near total immersion of an observer in a three-dimensional, synthetic environment in which the observer interacts with the environment.

Simulation. Simulation is frequently used to evaluate the maintainability characteristics of a design. Mockups can be built to represent a finished product so that access for performing maintenance, for example, can be evaluated.

Virtual Reality. VR is a method of simulating an environment that:

- is too dangerous for an observer
- lacks elements, such as an aircraft or other item of study
- does not exist
- is not accessible

Three different types of VR have been developed. Although not all these types exactly fit the definition of virtual reality, they do represent variations of the same basic technology.

¹¹Very sophisticated mockups have been constructed. For example, an expensive, full-scale, left half (bisected down the longitudinal axis) of the B-1A bomber was built by Rockwell. The wing was sweepable. Normally, mockups are relatively simple and inexpensive.

The three types of VR are:

- Telepresence in which observers perceive and interact with a distant environment
- Augmented reality, a combination of a real and synthetic environment, in which a real environment is annotated or augmented with additional details or elements
- Virtual reality in which a synthetic environment is created for the observer

Telepresence is used when the environment is dangerous or inaccessible. An example of the former case is disarming a bomb, a hazardous task for a person, even if wearing a helmet, body armor, and other safety devices. A robot equipped with telepresence can be operated by an operator located a safe distance from the bomb with almost the same feeling of "being there" as if he or she were actually at the site of the bomb. An example of the latter case is controlling robots in earth orbit from a ground station on earth.

In augmented reality, information and details are "added" to the real world, providing guidance, instructions, and so forth to help an observer's understanding or performance. Three examples follow. First, in an augmented reality approach to video conferencing, a three-dimensional image of a new product still in design could be generated from computer-aided design (CAD) files and "placed" on the desk or table in front of each conferee. The nomenclature of parts could be "superimposed" on them and would "follow" them no matter how they were moved within the range of the video camera. Another example of the use of augmented reality is the superimposing of the proper locations for drilling holes in an aircraft skin with other information, such as proper hole size. Finally, surfaces or features of an item that are physically occluded can be displayed as an overlay so that an observer can "see" them without disassembling the item.

In a total virtual reality environment, nothing (or very little) but the user is "real." Objects and their physical characteristics, the physical environment, the time of day, and so forth are all generated by a computer and displayed to the user, usually through goggles or a helmet. The user "sees" and can interact with objects in the environment.

Applications for Maintainability. VR has definite applications for designing maintainable equipment. For example, based on computer-aided design data files, a virtual copy of the product can be "produced." The maintainability engineer can then enter a virtual environment (VE) in which maintenance can be "performed" on the product. The accessibility of components, whether an item fits in an allocated space, and the approximate time required to perform specific maintenance actions all can be evaluated using VR. Virtual copies of support equipment, such as dollies and lifting devices, can be evaluated by "performing" maintenance activities with them. VR maintenance aids could allow technicians to view virtual information panels "superimposed" (using augmented reality techniques) on the actual equipment. In general, virtual reality can be used by the maintainability engineer to analyze:

- reachability and access
- field of view
- posture

- lifting guidelines
- energy expenditure
- activity timing

In addition to designing for maintainability, VR has many potential training applications. Maintenance and manufacturing procedures, especially procedures that are seldom performed or are difficult to teach using conventional approaches, can be taught using VR. VR could also be used to train individuals in performing hazardous procedures, disposing of hazardous materials, or performing life-threatening procedures. For example, surgeons can now "perform" operations without actually using any physical tools or a live patient.

As has been the case with previous new technologies, the possible uses of VR cannot be fully appreciated or anticipated. As VR matures, the applications related to design for maintainability will certainly increase in number and in fidelity.

4.3.2.4 Handbooks and Other Reference Documents. Hard-copy handbooks and similar reference documents are considered by some to be passé in today's world of computer-based design and virtual reality. None-the-less, much of the knowledge gained over the years as well as new information is documented in handbooks, manuals, data books, and so forth. Guidance, rules-of-thumb, lessons-learned, and similar information, together with explanations make handbooks and other reference documents important resources for the engineer. Some older documents are being "digitized" for entry into computer data bases making it easier to search and update the information. Nearly all new documents are created in digitized form.

4.3.2.5 Artificial Intelligence. Various forms of artificial intelligence (AI) are beginning to be used in the field of maintainability, particularly in the design of diagnostic tools. Individual AI techniques include: Expert Systems, Fuzzy Logic and Neural Networks. The structural basis and respective advantages and disadvantages for each of these techniques is summarized in Table VIII.

TABLE VIII. Comparison of AI Techniques.

Technique	Basis	Advantages	Disadvantages	Application to Maintainability
Rule-Based Expert System	"IF...THEN" Logic	Audit trail possible	Difficult to capture "intuitional" rules	Expert systems for design and for fault diagnosis. Based on knowledge of human "experts".
Model-Based Expert System	Functional System Model	Specific models are available	Requires the development of a unique model for each problem	Expert systems for design and for fault diagnosis. Adds model of problem to expert knowledge.
Fuzzy Logic	Converts discrete logic into continuous values	1) Eliminates stepwise approximations 2) Easy to "Fine Tune"	Each individual output must be "defuzzified"	Expert systems for design and for fault diagnosis. Allows for non-discrete inputs and outputs.
Neural Network	Numerous interconnected simple processing modes	1) Trained by example 2) Insensitive to "Noise" 3) Able to capture "Intuitional" rules	1) No theoretical understanding 2) No practical guidelines 3) No audit trail possible	Expert systems for design and for fault diagnosis. Can be "trained" by non-experts. Can capture intuitional as well as procedural rules.

4.3.2.5.1 Expert Systems. "Expert systems" are becoming an important maintainability tool, especially as industry downsizes with a concomitant loss of individual company "maintainability experts." Expert systems are used to "capture" and codify the knowledge of one or more experts in a given field or area of study and to make this knowledge available to non-experts.

For maintainability, a major use of expert systems is in diagnostic tools. The diagnostic capability of expert systems has been successfully demonstrated in both the medical and maintainability fields. Whether the problem is to identify a specific illness afflicting a patient or to identify the cause of an observed system or equipment failure, expert systems have proved to be efficient and effective.

Another potential use of expert systems in the field of maintainability comes as a result of "downsizing" and the use of integrated product design teams (IPDTs). As companies have downsized, the number of individuals employed as "maintainability engineers" has decreased. Many years of corporate experience are being lost and the few remaining maintainability engineers are spread thin. Where IPDTs are used, an engineer who may know very little about maintainability, may very well be given the responsibility for that aspect of design. Expert systems can help "replace" the maintainability engineer and assist those given the responsibility for maintainability design. As part of a computer-aided design system, an expert system could guide the designer in equipment placement, selection of fasteners, design of access panels and hatches, and so forth.

Although no companies were found using expert systems as a maintainability design tool at the time this handbook was published, many were developing knowledge bases. McDonnell Douglas, for example, is consolidating thousands of design "rules" that have been developed over the years for a variety of products, including fixed-wing aircraft and helicopters. Entered into a data base, these design rules will be available to the engineers as part of the CAD system used by McDonnell Douglas. Such a knowledge base, as will be discussed in 4.3.2.5.1.1, is an essential part of a rule-based expert system.

Two distinct types of expert systems are used: rule-based and model-based.

4.3.2.5.1.1 Rule-Based Expert Systems. Rule-based expert systems operate through a set of "IF...THEN" rules processed by an underlying "inference engine". A typical rule-based expert system is composed of four major elements: the Inference Engine, a Knowledge Base, a User Interface and an Explanation Facility.

The *Inference Engine* is that part of the expert system that performs the reasoning. It is analogous to the raw intelligence of a human expert. Many different forms of inference engines exist, but all are designed to perform the same task, i.e., to examine the current facts and use available rules to generate new facts.

The *Knowledge Base* is where the information resides within the expert system. It consists of two distinct parts: the *rule base* "IF <condition> THEN", and the *fact base* containing simple statements about the condition of the world, as it is applicable to the problem under study.

The *User Interface* enables the expert system and the user to communicate. The exact form of this interface depends on the intended audience for the expert system.

The *Explanation Facility* presents the user with the expert system's justification for its conclusions, i.e., an audit trail, as necessary.

A typical expert system initially partitions the problem by applying a broad set of inference rules to an initial set of data describing the problem or the symptoms. Each of these inference rules will take the inference engine to a further data-acquisition stage (typically another, more directed, questionnaire) or the establishment of a new fact. This process of a directed search with additional data gathering continues until the expert system has reached a leaf node in the resulting decision tree. Some inference engines may resolve an ambiguity, when several inference rules evaluate as TRUE to a given data set, by selecting the one with the highest associated weighting or confidence factor; others may use a different approach (e.g., fuzzy logic -- see 4.3.2.5.2).

The rules in the knowledge base, that portion which drives any expert system, are painstakingly constructed by an expert systems specialist interrogating the knowledge expert and subsequently codifying the often imprecise descriptions of their thinking processes into inference rules, possibly with numerical limits. For example a rule for a medical diagnostic expert system may state:

"IF heart rate > 100 beats per minute AND body temperature > 101°F
THEN recommend that patient be placed in an ice bath".

The *fact* portion of the knowledge base would simply record the patient's heart rate and temperature.

A general approach for the physical development of a maintainability expert system is shown in Figure 9.

It may be difficult to capture all of an expert's knowledge in an expert system knowledge base because the expertise is encoded as a causal relationship. "Rational" knowledge, where the solution can be described analytically, is comparatively straightforward to codify into inference rules. "Semi-rational" knowledge, where the expert can specify suitable ranges for conditions, but cannot (easily) defend the choice of these ranges are more difficult. This process may take some detective work by the expert system specialist. Unfortunately, however, much of what "makes an expert" occurs at an intuitional or visceral level, where even the expert is unaware of the underlying mechanism behind their decisions and may even be unable to quantify appropriate ranges. This area presents the major challenge and limitation in the design of a rule-based expert system. The following three sections will address some alternative solutions to this problem.

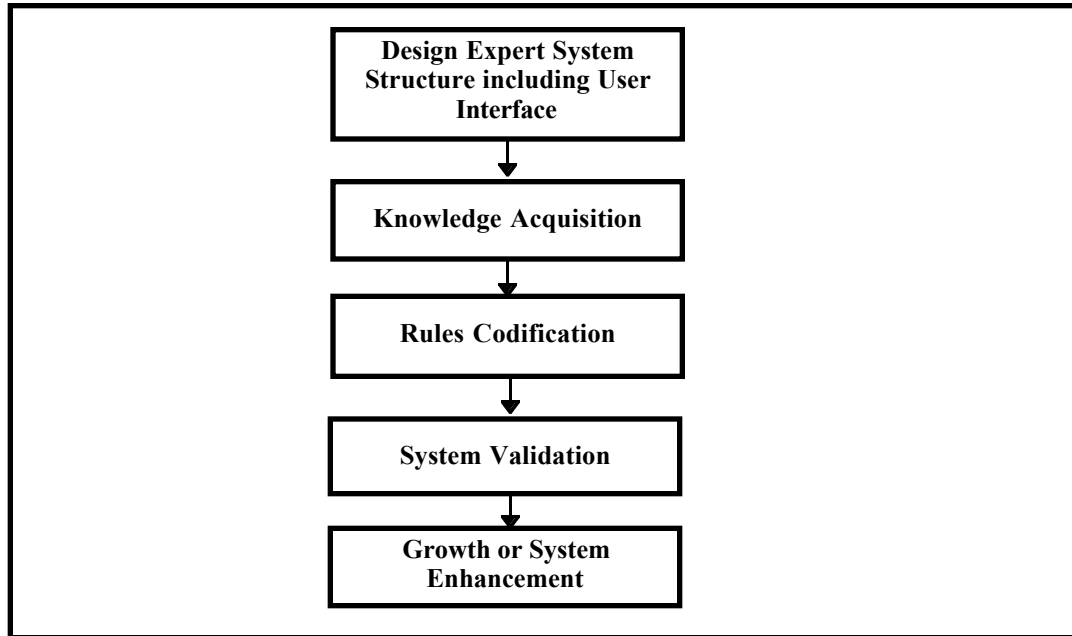

FIGURE 9. Steps in a General Approach for the Physical Development of a Maintainability Expert System.

4.3.2.5.1.2 Model-Based Expert Systems. The second type of expert system - the model-based system - uses a specific functional model to diagnose the observed symptoms and devise a solution to the problem. The knowledge base is usually organized around a functional or representative model of the system, but it is sometimes preferable to use an actual physical model. This model now provides the procedure with a focus of attention directed toward expected goals and guides the process in determining the effects of system/equipment failure symptoms. In the area of testability a number of detail models have been developed. These include models such as: WSTA, STAT and STAMP which are addressed in more detail in section 4.4.1.3.4.1 of this handbook.

4.3.2.5.2 Fuzzy Logic. Fuzzy logic is essentially an expert system structure tailored to deal with continuous-valued inputs and outputs instead of discrete lexical elements. Thus, fuzzy logic can potentially reduce the number of rules required in a system. This is achieved through clever preprocessing of the inputs, where each continuous input value is "fuzzified" or converted from a precise numeric value to a degree-of-membership in a "fuzzy set" as shown in Figure 10. Fuzzy logic is attractive because it allows for conflicting "expert opinion," thereby allowing the use of information normally excluded from scientific models. For design, fuzzy logic can be used to define a range of feasible design parameters even when historical data are insufficient to use tractional probability-based approaches.

When an input falls into a region where two or more fuzzy sets overlap, it simply produces a degree-of-membership in each of the overlapping sets. An output term of a fuzzy logic system is itself a fuzzy set, which must be "defuzzified" or converted back to a precise (i.e., "crisp")

numeric value. This is done by taking the centroid of the part of the output fuzzy set lying below the degree-of-membership output value. This degree-of-membership can result from a straight mapping of input fuzzy set to output fuzzy set, as shown by Rule 1 in Figure 10, or from a logical combination of rules¹² as used in an expert system (Rule 2 in Figure 10). When two or more inference rules trigger on a given output, the "crisp" output is calculated as the centroid of the areas of the contributing rules.

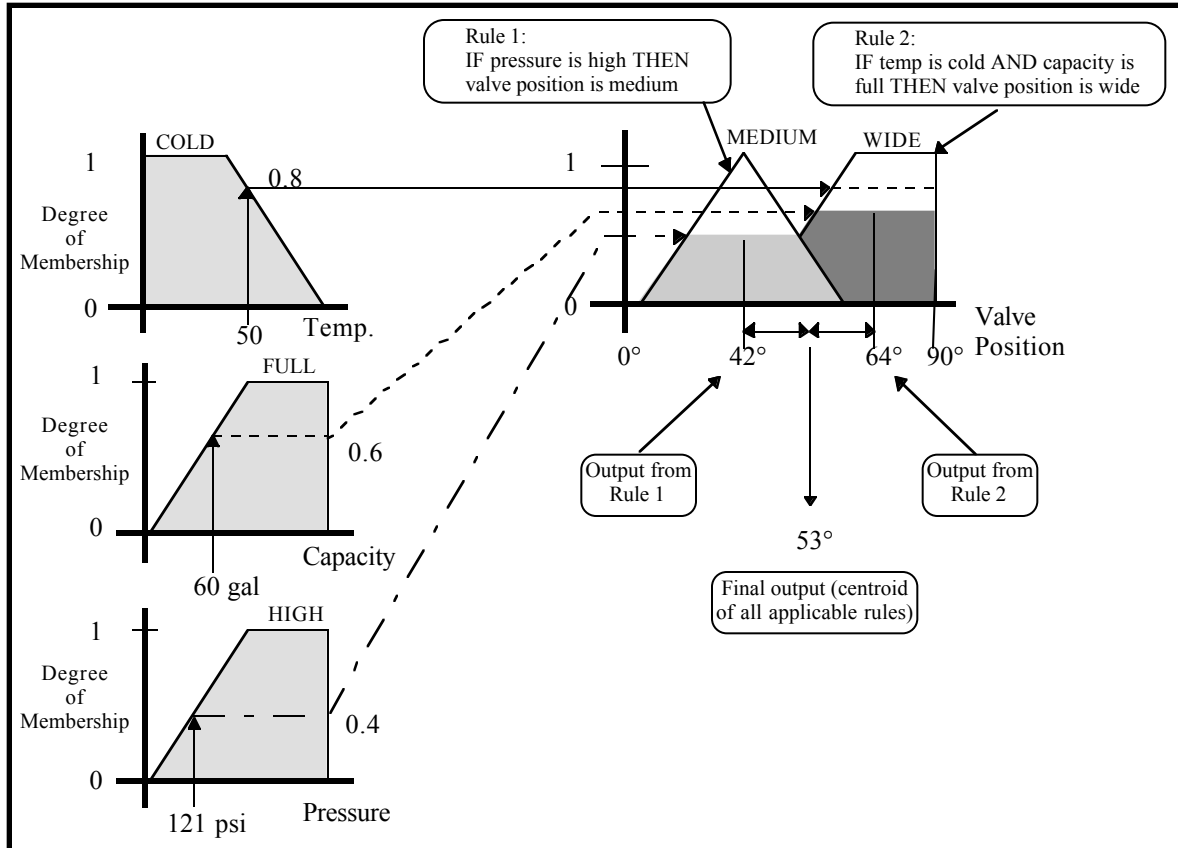

FIGURE 10. Fuzzy Logic Set Membership.

By providing the means for an expert system structure to treat continuous inputs and outputs as lexical elements, it eliminates the stepwise approximation a classical expert system would normally be forced to use in such a situation. This significantly reduces the number of inference rules required and makes the program structure more clear. Also, because the mapping between inputs, outputs and lexical elements is done via simple curve functions, a fuzzy system is easier to "fine tune". Thus a given fuzzy solution can be taken to other similar domains by rescaling or reshaping the input and output curves while leaving the logical inferences unchanged.

4.3.2.5.3 Neural Networks. Artificial neural networks consist of a large number of densely-interconnected simple processing nodes, each of which produces a non-linear result of a weighted

¹² The AND operator selects the smallest degree-of-membership of its operands, while the OR operator selects the largest degree-of-membership.

sum of its inputs (e.g., the output is a binary "1" if the sum exceeds a set threshold). The input stimuli and/or the outputs of other neurons are typically as shown in Figure 11. While there are numerous architectures of neural networks, they all work by partitioning the N-dimensional stimulus space into a series of continuous regions and as such, serve as "feature detectors" where the output (1,0) of an output-stage neuron represents the presence or absence of a desired feature. This behavior is especially useful in pattern recognition.

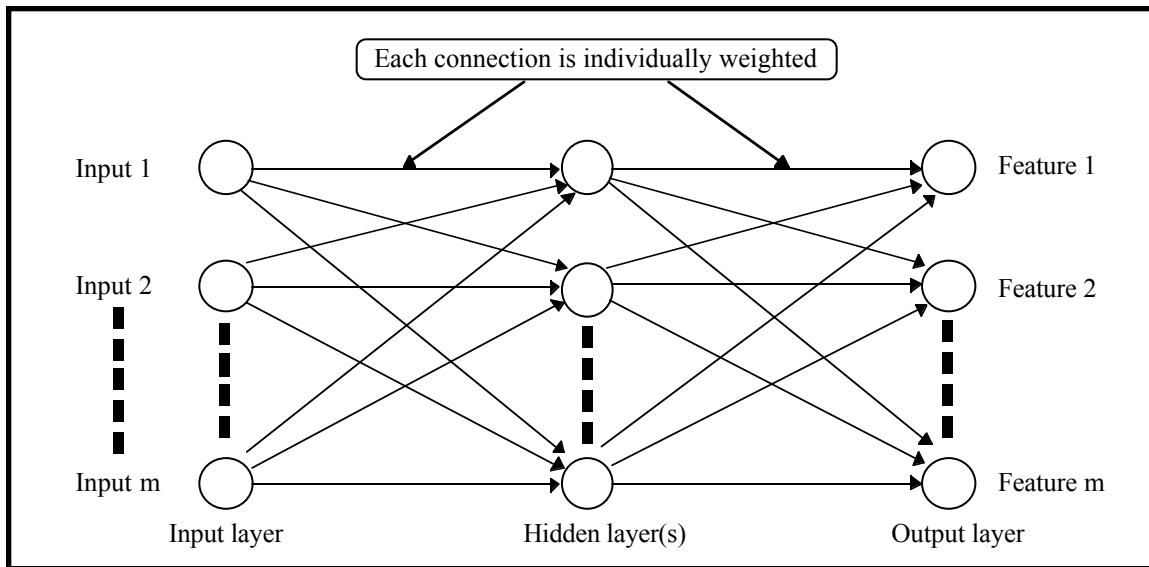

FIGURE 11. Typical Neural Network Configuration.

Neural networks, unlike expert systems or fuzzy logic, do not partition the stimulus space based on explicit rules. Rather, they are "trained" with sets of example stimuli and desired outputs. The training procedure gradually adjusts the weighting coefficients on each neuron's input until the global error is minimized. Successive training sets for other stimulus-response sets alter the coefficients, but a "memory" of previous training sets remains. Given a sufficient number of training sets, the neural network gradually converges to a stable set.

Neural nets have four significant advantages over expert systems:

- 1) While they are slow to train, neural networks can be trained by someone who is not an expert in the field (the training data sets, however, must be prepared by such an expert). This can translate into considerable time and cost savings.
- 2) Because the network is trained by example, it can capture the intuitional expertise as well as the procedural aspects.
- 3) The neural net automatically creates contiguous regions in the stimulus hypercube, eliminating the: region gap, overlap, and understatement problems inherent in expert systems.

- 4) Neural networks have been shown to be robust in the face of the noisy data found in nature. They require little or no sensor calibration or special non-linear quantization schemes.

Several factors, however, mitigate against the use of neural networks. These include:

- Lack of a sound theoretical understanding of neural networks.
- Absence of practical guidelines for selecting amongst the multitude of competing architectures. Network architecture is often a matter of personal taste.
- Lack of an established means for determining the correct number of neurons to use in a given architecture for a given problem. Practitioners typically add neurons until they achieve a desired level of network stability.
- Neural networks are sensitive to the training data: With too little training neural nets tend to misidentify stimuli (i.e., mispartition stimuli space). They can also exhibit pattern sensitivity to some data sets. That is to say, the network will not converge to a stable configuration, but oscillates between two or more metastable regions.
- Attempts to deal with metastability and divergence often incur a rapid growth in the number of neurons.
- Neural networks are unable to provide an audit trail showing how or why an incorrect decision was made. This makes them much harder to debug than expert systems, and also poses some interesting liability issues.

In summary, neural networks provide several distinct advantages over classical expert systems, most notably, a) training by example, b) robust pattern matching in the face of noisy or incomplete data, and c) the ability to capture an expert's intuitive knowledge. However, they operate "mysteriously", in a field with few landmarks. This makes neural network solutions difficult to develop.

4.4 Maintainability Analyses and Test

4.4.1 Analyses. This section first discusses the objectives of maintainability analyses. Next, the typical products or outputs of maintainability analysis will be outlined. Finally, brief descriptions will be provided of the most common maintainability analyses.

4.4.1.1 Objectives of Maintainability Analyses. Maintainability analyses have five main objectives.

- To establish design criteria that will provide the necessary maintainability features
- To support the evaluation of design alternatives and trade-off studies
- To provide inputs to the process of identifying and quantifying support requirements (spares, training, support equipment, etc.)

- To evaluate the effectiveness of the support concept and maintenance policies and to identify needed changes to the concept and policies
- To verify that the design complies with the maintainability design requirements

4.4.1.2 Typical Products of Maintainability Analyses. The products of performing maintainability analyses include but are not limited to:

- Mean and maximum times to repair (at various levels of maintenance and at platform and unit level)
- Inputs to level of repair analysis
- Maintenance time or labor hours per task or operating hour
- Inputs to maintenance personnel requirements (e.g., number required, existing or special skills, etc.)
- Inputs to spares requirements
- Support equipment requirements
- False alarm rates, methods of fault detection, and effectiveness of BIT
- Mean time between scheduled and preventive maintenance
- Maintainability Models and Block Diagrams

4.4.1.3 Commonly Used Maintainability Analyses. The depth and scope of any analysis will vary with the design detail available and the complexity of the equipment. Some analyses are performed for other purposes. For example, an FMEA is usually performed as part of the reliability effort to identify potential weaknesses in the design. In such cases, to avoid duplicative effort, it must be decided who will be responsible for the analysis.

The various types of maintainability analyses include but are not limited to (a brief description of each of these analyses follows):

- Equipment Downtime Analysis
- Maintainability Design Evaluation
- FMEA
- Testability Analysis
- Human Factors Analysis

4.4.1.3.1 Equipment Downtime Analysis. Equipment downtime analysis is used to evaluate the expected time that a piece of equipment is not available (i.e., it is down) due to maintenance or a supply backlog. This value is the sum of elapsed maintenance time, awaiting parts time, and awaiting maintenance time. It is a primary measure of merit that considers reliability, maintainability, support system attributes, and operational environment. The results of this analysis may be used to calculate other equipment measures of merit, such as mission capable

rate and equipment availability. The results of the analysis indicate those areas driving non-availability of the equipment and are used to evaluate alternative design and support concepts based on total system downtime.

Equipment downtime is derived by using the reliability and maintainability parameters and support parameters. Downtime (DT) is the sum of elapsed maintenance time (EMT), awaiting parts (AWP) time, and awaiting maintenance (AWM) time, and can be expressed as:

$$DT = EMT + AWP + AWM \quad (\text{Equation 5})$$

where: This parameter indicates repair time for corrective (unscheduled) maintenance. EMT is a function of failure rate, maintenance action rate, maintenance action to failure ratio, and mean time to repair. It can also include administrative and logistics delay.

AWP time combines mean operating hours between demands, not repairable this station (NRTS) rate, and expected available inventory to determine the expected length of time a part is not available due to stockout conditions.

AWM time is the expected length of time the equipment cannot be worked on due to any other considerations such as unavailable personnel, administrative delays, logistics delays other than spare parts (e.g., support equipment), and weather delay. This is usually derived from field data.

Equipment downtime analysis is typically performed at the total system level to provide the operator with information that can be used for: (1) alternative design or support system concept comparisons, (2) operations or mission planning, and (3) readiness capability assessment. Individual subsystems and lower indenture equipment items can also be evaluated using this analysis approach to identify the effects of individual equipment modifications or high-driver contributors to overall system downtime.

Equipment downtime analysis may be used any time during the program or product life cycle. The depth of this analysis increases as the system is more completely defined and parametrically described in the later phases of a program. Early use of downtime analysis will provide criteria to influence design for supportability, while later use will point out corrective actions that can be taken through changes in the design or support system.

Equipment downtime analysis results in a figure of merit called "equipment downtime," measured in hours, days or other time cycle appropriate for the equipment evaluated. It can be used to identify areas driving system non-availability, to compare alternate design or support system concepts, and as input to other equipment capability measures.

4.4.1.3.2 Maintainability Design Evaluation. Maintainability design evaluation is the process of analyzing the maintenance implications of a proposed or evolving design and

providing feedback to the designer in a timely manner. A major goal of this evaluation is to ensure that maintainability is designed into the product from the start.

The process starts with a set of standards available to the designer and maintainability engineer. These standards normally consist of a preliminary "use study," maintenance concept, qualitative and quantitative maintainability requirements, and lessons learned. The in-process evaluations refine the maintenance concepts that will later form the basis for the maintenance elements of logistics support analysis.

The depth of this analysis depends on the phase that the design program is in at the time and the complexity of the equipment being designed. More complex equipment will need extensive evaluation to ensure that all maintainability requirements are being met. The design criteria in Appendix C provide a basis for evaluating a design for maintainability.

4.4.1.3.3 Failure Modes and Effects Analysis (FMEA). Traditionally, the FMEA (referred to as a Failure Mode, Effects, and Criticality Analysis, or FMECA, when the criticality of failures is also determined) has been used as a reliability analysis and design tool. However, the results of an FMEA are also a key input to the design for maintainability. The FMEA helps establish the necessary maintainability design characteristics based on potential failure modes and their effects on subsystems, equipment, and product operation. The results of the FMEA are used to determine placement and nature of test points, to develop troubleshooting schemes, to establish design characteristics relative to the ease of maintenance, and to develop fault detection and isolation strategies (the use of an FMEA as an input to testability analysis is discussed in 4.4.1.3.4).

Some of the prime outputs of an FMEA, from a maintainability viewpoint, include:

- Identification of single point failures
- Fail-safe design deficiencies
- False alarm occurrences
- Operator/maintenance person safety considerations
- Potential failure detection methodology, including
 - Protective and warning devices
 - Failure over-ride features
 - Built-in test (BIT) provisions

The FMEA should describe the means by which the occurrence of a specific functional failure (failure mode) is detected and localized by the operator or maintenance person. FMEA outputs are very important to the design of a system's diagnostic system, which may include BIT. By identifying both local and next higher level effects of each potential system failure mode, methods for identifying, annunciating, and isolating the failures modes that affect system operation can be devised. Any applicable warning devices, BIT indications, or other indications which make evident that an item has failed or malfunctioned should be clearly identified. If no such indication

exists, the situation should be flagged in the FMEA as a potential maintainability problem. Proper recognition of an item failure or malfunction requires that normal, abnormal, and incorrect indications be known. A normal indication is one that is obvious to an operator or maintenance person when the item is operating normally. Abnormal and incorrect indications are those that are evident when an item has malfunctioned or failed.

As indicated in the list of maintainability-related FMEA outputs, an FMEA can be used to identify potential false alarms. False alarms often occur when the system's BIT detects and annunciates a failure during operation that cannot be repeated or duplicated later at the initial maintenance level. A false alarm can occur when the failure is an out-of-tolerance condition that exceeds the preset BIT limits that define "good" indications of system operation. The FMEA can be used to identify those failure modes that result in an out-of-tolerance condition rather than in a hard failure. This knowledge can then be used to design the BIT so it recognizes such a condition and only declares a failure if the condition persists over a specified period (time, cycles, etc.) of operation. This is one example of how an FMEA can be used to avoid false alarms. Another example is when the out-of-tolerance condition has no effect on system operation. Without this knowledge, the BIT could be designed to declare a failure, resulting in an unnecessary mission abort. With such knowledge, the BIT can be designed to ignore (intentionally over-ride) this condition, allowing the mission to be completed.

Finally, the FMEA can be used to identify failures that are undetectable but have no effect on the mission. In such cases, the consequences of a second failure can be analyzed. For those cases in which the mission would be jeopardized by the second failure, the FMEA can be used to determine whether or not a failure indication would now be evident to the operator, maintenance person, or BIT.

Figure 12 illustrates the steps in an FMEA. As mentioned earlier, when the criticality of each failure mode is also determined, the analysis is known as a FMECA. Figure 13 illustrates a typical FMEA worksheet. References that describe a detailed methodology for performing an FMEA are listed in Appendix F. Note that the text of the Society of Automotive Engineers (SAE) document J-1739 is essentially identical to that of Automotive Industries Action group (AIAG) document "Potential Failure Modes and Effects Analysis (FMEA)". Both are listed in Appendix F for the sake of completeness and to avoid the impression that one is preferred over the other. Finally, Figure 14 shows an abbreviated results of an FMEA performed on a solid rocket motor.

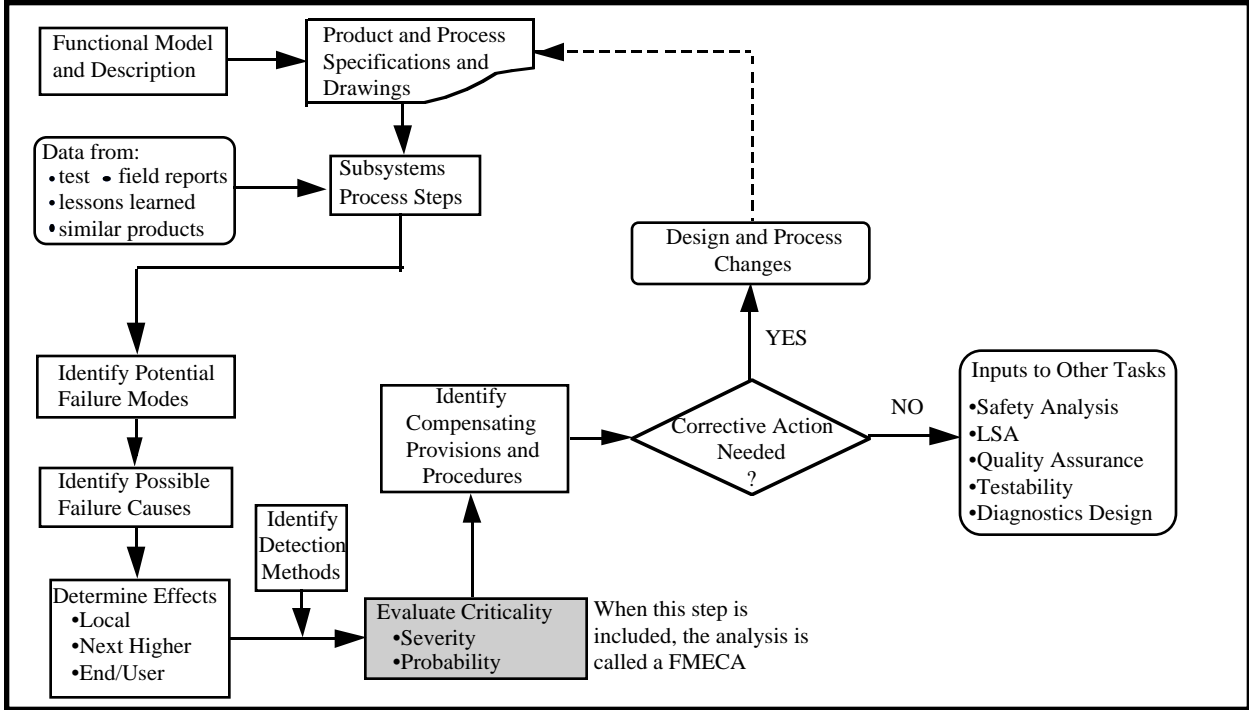

FIGURE 12. Steps in an FMEA.

FAILURE MODES AND EFFECTS ANALYSIS							
Product: _____				Date: _____			
Indenture Level: _____				Sheet ____ of ____ Sheets			
Reference Drawing: _____				Completed by: _____			
Mission: _____				Approved by: _____			
ID Number	Nomenclature	Function	Modes	Causes	Effects	Detection Method	Compensating Provisions

FIGURE 13. Typical FMEA Worksheet.

FMEA			
1. Subsystem: <u>Rocket Motor</u> 2. FMEA Prepared by: <u>A. N. Engineer</u> 3. Date: <u>January 3, 1993</u>			
Component or Item	Failure Mode	Cause of Failure	Effects
1. Motor case	1. Rupture	1. Poor workmanship 2. Defective materials 3. Damage during shipping 4. Damage during handling 5. Damage during storage 6. Overpressurization	Destruction of missile
2. Propellant grain	1. Cracking 2. Voids 3. Bond separation	1. Abnormal stresses from cure 2. Excessively low temperature 3. Aging	1. Excessive burn rate 2. Overpressurization 3. Motor case rupture during operation
3. Liner	1. Separation from case 2. Separation from motor grain or insulation	1. Inadequate cleaning of case after fabrication 2. Unsuitable bonding material 3. Bonding process inadequate or not in control	1. Excessive burn rate 2. Overpressurization 3. Motor case rupture during operation

FIGURE 14. Abbreviated Results from FMEA of a Solid Propellant Rocket Motor.

4.4.1.3.4 Testability Analysis. Testability analysis is important at all levels of design and can be accomplished in a variety of ways. For instance, when designing complex integrated circuits (ICs), such as Application Specific ICs, or ASICs, it is important to develop test vectors that will detect a high percentage of 'stuck at' faults (i.e., signal stuck at logic '1' or '0'). This is almost always determined via logic simulation wherein a model of the design is developed in an appropriate fault simulation language. Once the model is compiled and ready to be simulated, a set of test vectors are applied to the model. The fault simulation program then produces a list of faults detected by the test vectors, as well as reporting the percentage (or fraction) of faults detected. Many such programs also identify specific signals that were not detected such that adjustments can be made either in the design or in the test vectors themselves in order to increase fault detection percentage.

For non-digital electronics, fault detection efficiency is typically determined with the aid of an FMEA. The FMEA will provide those faults that result in an observable failure, and can therefore be detected. The test engineer then must develop a test that will verify operation and detect any malfunctions as identified in the FMEA. Fault detection percentages are then determined by summing the number of faults identified in the FMEA that are detected versus the total number identified as being detectable. This process can occur at all levels of design. The fault grading methods described in the first paragraph above are primarily applied at the IC and printed circuit card levels.

In addition to determining fault detection percentage, a testability analysis should be performed to determine the fault isolation effectiveness of designed tests. For digital electronics, many of the tools used to grade test vectors also provide statistics on fault isolation percentages. This is

typically provided by creating a fault dictionary. During fault simulation, the response of the circuit is determined in the presence of faults. These responses collectively form the fault dictionary. Isolation is then performed by matching the actual response obtained from the circuit or test item with one of the previously computed responses stored in the fault dictionary. Fault simulation tools can determine from the fault dictionary the percentage of faults that are uniquely isolatable to an ambiguity group of size n ($n = 1, 2, 3, \dots$). These tools can be used to verify fault isolation goals or requirements via analysis, prior to actual testing. For non-digital circuits, hybrid circuits or even digital systems above the printed circuit card level, analysis of fault isolation capability can be performed with the aid of a diagnostic model and a software tool that analyzes that model. Examples are dependency modeling tools such as the Weapon System Testability Analyzer (WSTA), System Testability Analysis Tool (STAT) or the System Testability and Maintenance Program (STAMP)¹³. These tools, and others like them, can be used to determine the fault isolation capability of a design based on the design topology, order of test performance, and other factors such as device reliability. Statistics such as percentage of faults isolatable to an ambiguity of group size n are provided, as is the identification of which components or modules are in an ambiguity group for a given set of tests. Test effectiveness and model accuracy are the responsibility of the test designer, however.

4.4.1.3.4.1 Dependency Analysis. Assessing testability via dependency analysis has gained in popularity recently, and it is therefore prudent to provide some additional information on this technique. Dependency analysis starts with the creation of a dependency model of the item to be analyzed. The model is designed to capture the relationship between tests or test sites within a system, and those components and failure modes of components that can affect the test. As an example, consider the simple functional block diagram shown in Figure 15.

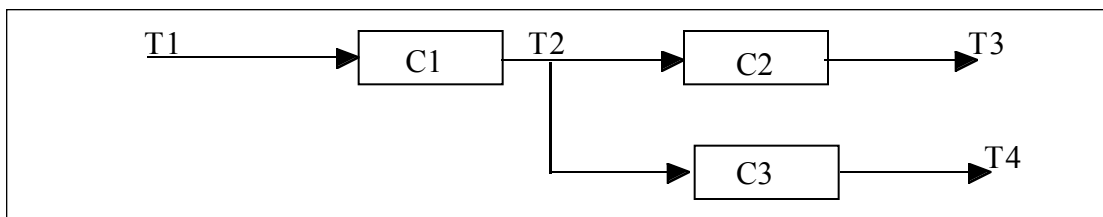

FIGURE 15. Simple System Showing Test Dependencies.

The dependency model for the system, in the form of a tabular list of tests and their dependencies is provided in Table IX.

¹³ STAT is a registered trademark of DETEX Systems, Inc. and STAMP is a registered trademark of the ARINC Research Corporation. WSTA is a tool developed by the US Navy and available to most US Government contractors and US Government employees.

TABLE IX. First Order Dependency Model for Simple System.

Test	First-Order Dependencies
T1	None
T2	C1, T1
T3	C2, T2
T4	C3, T2

Figure 15 has been labeled to identify each potential test site within the system, where in this example, exactly one test is being considered at each node. The dependency model shown in Table IX is a list of "first-order dependencies" of each test. For example, the first order dependency of test T3 is C2 and T2. This would indicate that T3 *depends* upon the health of component C2 and any inputs to C2, which is T2 in this case. For this simple system, it is also obvious that T3 will also depend on C1 and T1, but these are considered higher-order dependencies. Each of the tools mentioned previously (i.e., STAT, STAMP and WSTA), determine all higher order dependencies based on a first order dependency input model.

Dependency modeling is attractive due to its applicability to any kind or level of system. Note in the example that neither the nature nor level of the system is required to process the model. Consequently, this methodology is applicable to most any type of system technology and any level (i.e., component to system).

Based on the input model, the analysis tools can determine the percentage of time isolation to an ambiguity group of n or fewer components will occur. In addition, each of the tools discussed will also identify which components or failures will be in the same ambiguity group with other components or failures. Furthermore, any test feedback loops that exist, including those components contained within the feedback loop, will also be identified. Note that the ambiguity group sizes and statistics are based on a binary test outcome (i.e., test is either good or bad), and in most cases the tools assume that the test is 100% effective. This means that if the model indicates that a particular test depends on a specified set of components, the tools assume that should the test pass, all components within the dependency set are good. Conversely, a failed test makes all of the components within the dependency set suspect. Therefore, the accuracy of the model, in terms of what components and component failure modes are actually covered by a particular test are the responsibility of the model developer. The coverage is very much dependent upon test design and knowledge of the system's functional behavior.

Even before intimate knowledge of what tests are to be performed is known, such as in the early stages of system development, a model can be created that assumes a test at every node, for instance. The system design can be evaluated as to where feedback loops reside, which components are likely to be in ambiguity, and where more visibility, in terms of additional test points, need to be added to improve the overall testability of the design. Once the design is more developed, and knowledge of each test becomes available, the dependency model can then be refined. Given that the analyst is satisfied with the model results, each of the tools discussed can be used to develop optimal test strategies based on system topology and one or more weighting

factors such as test cost, test time, component failure rates, time to remove an enclosure to access a test point, etc..

One of the drawbacks in the past to dependency modeling has been the time it takes to create a model. However, translation tools exist and are continuously being developed that can translate a design captured in a CAD format, such as the Electronic Data Interchange Format (EDIF), into a dependency model compatible with the specific dependency analysis tool being used. The analyst is still responsible for verifying the accuracy of the model, however, as in some cases, not all dependencies will be 100% correctly translated. Despite this fact, the amount of time that can be saved in translation outweighs any additional time it may take to verify the model.

4.4.1.3.4.2 Dependency Analysis Tools. The three tools mentioned, STAT, STAMP and WSTA, provide the same basic kinds of outputs as just discussed. Each tool has other features that may be attractive depending on the system being analyzed, CAD tools being used in the design process, etc. Therefore, more information should be gathered on these and other similar tools prior to making a final decision as to which one to acquire. Contact information for STAT, STAMP, WSTA, and similar tools is provided in Appendix F.

The key points to remember about any of these tools is that model accuracy is most important. Therefore, it is important to understand how the system behaves in the presence of a failure, and which tests can be developed to detect such behavior. Thus, to gain the most benefit from the model development process, experts in design and test should be involved. For additional information on dependency analysis and dependency analysis tools and their applications, see references listed in Appendix F.

4.4.1.3.4.3 Other Types of Testability Analyses. Other types of analyses that do not require the use of a software tool are ad hoc procedures, such as reviewing a design against a known set of testability design practices, such as the checklist found in Appendix C. Grumman, and later Raytheon, developed such a procedure for the US Air Force Rome Laboratory that rates a design based on the presence or absence of design features that increase or decrease ease of test. The result is a score that is subjectively evaluated as indicating the design is anywhere between untestable without redesign to very testable. Used in conjunction with a design guide, also developed as part of the process by the mentioned companies, this method can be very effective in making the test engineer's job easier and less costly. Some of the testability design guidelines taken from the report referenced in the footnote¹⁴ are provided in Appendix C. Testability analysis is a combination of applying any of the above mentioned techniques to a system design, and should be tailored according to the design level and design technology.

4.4.1.3.5 Human Factors Analysis. One of the most basic maintainability requirements is that the system be easy to maintain by human personnel. Maintainability analysis of a system

¹⁴ RL-TR-92-12, VOLUMES I & II - Testability Design Rating System: Testability Handbook (Volume I) & Analytical Procedure (Volume II).

typically involves maintenance tasks that deal with the repair or removal and replacement of a part or subassembly. Maintenance tasks usually involve the disassembly, which is needed to access the target component, component repair or replacement and subsequent reassembly.

Thus, human factors analysis is performed to identify problems related to the interaction between maintenance personnel and the design model in performing each maintenance task. This analysis is used to verify that each required maintenance task, and its associated motions and manipulations, can be performed by humans. It deals more with the qualitative requirements than the quantitative requirements. Also, it is extremely important, that this analysis be done while the product is still in the early design stages, i.e., before any "metal is bent."

Human factors problems may involve the limited strength of maintenance personnel, limited or no work clearance required to carry out the task, i.e., accessibility problems and problems related to visual requirements of the maintenance person performing the task. Thus, human factors analysis involves three major considerations:

- Strength analysis
- Accessibility analysis
- Visibility analysis

Strength analysis. This analysis is used to determine the feasibility of the disassembly and assembly sequences. Determine whether or not the maintenance person is able to carry out a maintenance activity that requires a certain level of human strength. That is, to evaluate the ability of the maintenance person to carry, lift, hold, twist, push, and pull objects in a standard body position (i.e., standing, bending, sitting, squatting, lying, etc.). Strength analysis can be one of the most important criteria for the evaluation of a maintenance task.

Accessibility analysis. This analysis is performed to identify design problems related to the inability of maintenance personnel to access the work area, i.e., to detect possible collisions during the maintenance activity.

Visibility analysis. For some maintenance activities it is important (e.g. for safety considerations) that the maintenance person be able to fully observe the work area.

In the past, human factors analyses were very time consuming. They required the construction of expensive physical mock-ups to perform the analysis and also, unfortunately, the analysis was not done until the final stages of design, when modifications were very costly. However, there are a variety of modern, animated, computer-aided-design (CAD) tools and new virtual reality techniques available to assist the maintainability engineer in effectively and efficiently performing these analyses. Furthermore, when problems are discovered in the course of the human factors analysis, the proposed design modifications can be quickly verified for their effectiveness using these same tools and techniques.

4.4.1.4 Quantitative Measures of Maintainability. Quantitative maintainability requirements are associated with those design characteristics controllable by the designer. They are determined through an analysis of the customer needs and constraints as was discussed in 3.1, "Understand the Customer's Maintainability Needs." Customer-imposed constraints include:

- Expected operating time (or cycles) per unit of calendar time
- Maximum downtime or maintenance time, or required availability
- Operational environment and mission profile
- Skill types and skill levels of maintenance personnel
- Existing types of diagnostics and other maintenance support equipment available to support the product and customer
- Turnover rate of personnel

Quantitative maintainability requirements may be expressed using many different metrics and may be established at any or all levels of maintenance. For example, they may be structured as functions of time, labor hours, or in terms of fault detection and isolation. Examples of quantitative maintainability requirements include:

- Active maintenance in terms of corrective maintenance time in labor hours
- Mean preventive maintenance time in labor hours
- Mean active maintenance time in terms of mean labor hours per maintenance action
- Unit removal and installation times
- Inspection times
- Turnaround time
- Reconfiguration time
- Mean Time to Repair (MTTR)
- Mean Time to Restore System (MTTRS)
- Maximum Time to Repair [at a specified confidence level, Φ] ($M_{\text{Max}}(\Phi)$)
- Mean Manhours (MMH) per repair
- Mean Manhours per Operating Hour (MMH/OH)
- Mission Time to Restore Functions (MTTRF)
- Direct Manhours per Maintenance Action (DMH/MA)
- Mean Equipment Corrective Maintenance Time to Support a Unit Hour of Operating Time (MTUT)
- Maintenance Ratio (MR)
- Mean Time to Service (MTTS)

- Mean Time Between Preventive Maintenance (MTBPM)
- Mean Manhours per Flying Hour (MMH/FH)
- Probability of Fault Detection
- Proportion of Faults Isolatable
- Proportion of faults detected and percentage of time detected for failure modes to be detected or isolated by automatic or built-in test equipment
- Maximum false alarm rate for automatic or built-in test equipment

4.4.1.4.1 Maintainability Models and Maintenance Activities Block Diagrams.

Maintainability models and maintenance activities block diagrams are essential elements of maintainability analysis. Models and diagrams are developed and used as the basis for the allocation and prediction processes. Models also may be used as graphical representations of maintenance tasks and may be used to assess compatibility with the maintenance human resource requirements. Finally, models and diagrams are used to augment systems engineering tradeoff studies.

Models and maintenance activities block diagrams may be based on system engineering models, and are developed for alternative system concepts or configurations or for proposed design changes. The models and maintenance activities block diagrams must be well documented and used consistently throughout the design process. Figure 16 shows the maintenance activities block diagram for the following example maintenance task.

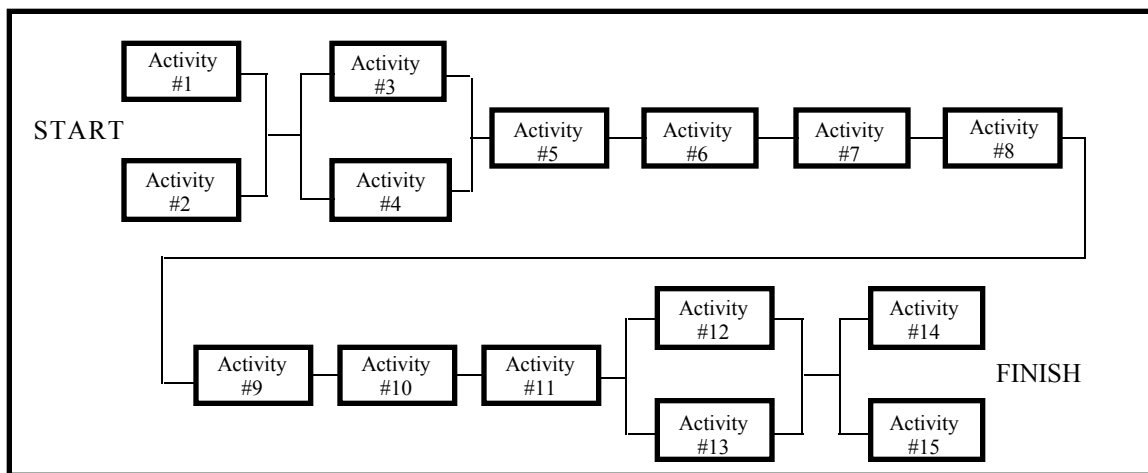

FIGURE 16. Maintenance Activities Block Diagram.

Example Maintenance Task (Reference Figure 4-12).

Task Description: Replace a receiver/transmitter (R/T) on an aircraft

Number of maintenance personnel: 2

Equipment/parts: Allen wrench, new R/T unit, maintenance stand, electrical power cart

- Activities:
1. Get Allen wrench from tool box (or tool bin)
 2. Get maintenance stand and position adjacent to R/T equipment bay
 3. Move electrical power cart to aircraft and connect to aircraft power connection
 4. Open access panel Tridair fasteners using Allen wrench
 5. Disconnect electrical cables with BNC connectors
 6. Unscrew ATR latches securing unit to rack and remove R/T
 7. Install new R/T and secure in position with ATR latches
 8. Reconnect electrical cables with BNC connectors
 9. Start power cart
 10. Apply power to and run operational checks on R/T unit using established procedures -- then turn power off
 11. Turn off power cart
 12. Close access panel; re-secure Tridair fasteners using Allen wrench
 13. Disconnect power cart and move away from aircraft
 14. Move maintenance stand away from aircraft & return to storage site
 15. Return Allen wrench to tool box (or tool bin)

Note the activities that can be done simultaneously (in parallel). Although it might be possible for one person to perform the task by doing each activity serially, two people make the job easier and, during application of electrical power and operational checkout, safer. Also note that both people are not needed during the entire maintenance action. The individual not performing activities 5, 6, 7, and 8 can perform other work in the vicinity of the aircraft.

As a minimum, maintainability models should consider:

- Operational maintenance concept
- Safety considerations
- Applicable levels of the system hierarchy
- List of line replaceable units (LRUs)
- Company policies

4.4.1.5 Qualitative Maintainability Factors. Any maintainability requirement that cannot be categorized as a quantitative requirement is, by definition, a qualitative requirement. Qualitative maintainability requirements encompass a wide variety of desired outcomes considered to be essential in ensuring the product is maintainable. For example, customers

usually want to minimize the number of new skills, support equipment, and tools, the use of safety wire, and the number and variety of fastener types. Such qualitative requirements are not useful to the designer (i.e., when is the number of new skills minimized?). So some measurable design rules must be established to ensure that the design reflects the qualitative requirements. Using some of the examples of qualitative requirements already given, for instance, design rules that are quantifiable might be:

- No less than 80% of all maintenance actions will be performed using only those tools in the customer's standard tool kit and no torque wrenches
- No safety wire or lockwire shall be used
- Existing skill levels must be used at all maintenance levels
- No more than 15% of all access panels will be designed to require more than 4 fasteners per side (or a total of 12 per perimeter)

4.4.1.6 Predictions, Allocations, and Assessments.

4.4.1.6.1 Maintainability Prediction. Maintainability predictions are estimates of design performance from a maintainability perspective. They serve as a means for comparing design options, assessing the feasibility of achieving maintainability requirements, and assessing progress in achieving the maintainability requirements. However, predictions are imprecise, the degree of imprecision being determined by the validity of assumptions, amount of available performance data, applicability of the method, and so forth. Predictions should, therefore, never be used as the sole basis for programmatic or engineering decisions.

The maintainability prediction is a useful tool for determining where to place the most emphasis in designing for maintainability. Each subsystem, equipment, and component can be evaluated in terms of failure rate, maintenance time required, and complex maintenance tasks. The designer is thus provided with the necessary visibility into the attributes of subsystems, equipment, and components to:

- Identify design weaknesses, from a maintainability perspective
- Support trade-off studies (e.g., relax maintainability requirement for a high reliability component and still achieve the same availability)
- Determine if the design is ready to proceed to next phase of development

The maintainability prediction is an iterative estimate of the future observed maintainability characteristics of the product. Prior to starting the prediction process, all assumptions must be specifically defined and evaluated as to their validity and applicability. Rationale must be provided for all assumptions.

The predictions also are useful in logistical planning. Early estimates of maintenance time, labor hours, and other maintainability metrics can be used in making preliminary assessments of the support equipment, spare parts, personnel, training, and other logistics resources required to maintain the system in operational use. As estimates are refined using test and demonstration data, the estimates of logistics resources can be revised. Although other factors determine the types and amounts of logistics resources to be acquired, maintainability predictions are important for this purpose and, in the early stages of a program, may be the only basis on which to plan logistics. By beginning the process of identifying logistics resources early in the program, a "fully operational" status can be rapidly achieved after the fielding of a new system.

A variety of methods and metrics are used to predict maintainability. Each prediction method is designed for a specific application. All depend on at least two basic input parameters. These two common parameters are:

- Failure rates of components at the specific level of assembly of interest
- Repair times¹⁵ required at the maintenance level involved

Historically, the most commonly used methods for maintainability predictions are those found in MIL-HDBK-472, "Maintainability Predictions."

4.4.1.6.1.1 Maintainability Prediction in Accordance with MIL-HDBK-472. Five different maintainability methods are documented in MIL-HDBK-472. The different prediction methods address different aspects of maintainability and each method predicts maintainability using different metrics.

Procedure I - This procedure typically is intended to be used to predict flight-line maintenance of **airborne electronic and electromechanical systems** involving modular replacement. It uses a calculation procedure based on a list of elemental activities for which normalized distributions and occurrence probability are given. The parameters used in this method are: the distribution of downtimes for various elemental activities, maintenance categories, repair times, and system down time.

Procedure II - This procedure typically is intended to be used to predict the maintainability of **shipboard and shore electronic** equipment and systems. It could be used to predict the maintainability of mechanical systems provided that task times and functional levels could be established. Procedure II contains two different approaches, Part A and Part B.

Part A: The parameter used is corrective maintenance time expressed as an MTTR in hours.

¹⁵ Most maintainability experts agree that repair times exhibit the skewed characteristics of the log-normal distribution. Thus, repair times are usually assumed to be log-normally distributed.

Part B: The parameters used are: active maintenance in terms of mean **corrective** maintenance time in **labor hours**, mean **preventive** maintenance time in labor hours, and mean **active** maintenance time in terms of mean **manhours per maintenance action**.

Procedure III - This procedure typically is intended to be used to predict the mean and the maximum active corrective maintenance down time for **Air Force ground electronic** systems and equipment. It also can be used to predict preventive maintenance down time. The parameters used in this method are: mean and maximum active corrective down time (at the 95th percentile), mean and maximum preventive downtime, and mean downtime.

Procedure IV - This procedure is intended to be used to predict the mean or total corrective and preventive maintenance downtime of systems and equipment. The parameters used in this method are: mean system maintenance **downtime**, mean corrective maintenance downtime per operational period, total corrective maintenance per operational period, and total preventive maintenance **downtime per operational period**.

Procedure V - This procedure was developed much later than the other four procedures and is by far the most versatile. Typically it is used to predict the maintainability parameters of avionics, ground and shipboard electronics at the organizational, intermediate and depot levels of maintenance. It presents a tabulation of time standards in relation to illustrations of what each time represents. The parameters used include: MTTR, $M_{Max}(\phi)$, MMH/repair, MMH/OH and MMH/FH

Significantly, all commercial computer software development to date has concentrated on Procedure V, to the exclusion of the other four maintainability prediction procedures. Therefore, only the procedure previously designated as "Procedure V" in MIL-HDBK-472 has been included as Appendix D, "Maintainability Prediction" in this handbook.

4.4.1.6.2 Maintainability Allocation. Maintainability allocation is the process of apportioning the system level maintainability requirements to lower levels of assembly. In other words, the system requirements are apportioned to each subsystem; each subsystem's requirements are apportioned to components and equipment within the subsystem; and, finally, the component and equipment requirements may be apportioned to modules.

Maintainability allocation requires a detailed analysis of the system architecture and a knowledge of the characteristics of various types of systems, subsystems, and so forth. Allocations are made primarily for corrective maintenance requirements. Historically, system-level requirements have been difficult to fully assess without a prototype or first-production version of the system. So allocations have been used to assess the progress being made toward achieving the system level maintainability requirement.

Maintainability allocations are a natural management tool. They are used by the customer, prime contractor, and subcontractors and suppliers to:

- Derive "not-to-exceed" maintainability values (i.e., maximum MTTR) for the system's lower level indentures of assembly
- Provide designers and maintainability engineers with a standard for monitoring and assessing compliance with stated maintainability objectives
- Identify areas needing additional emphasis (regarding maintainability) and areas where improvements in maintainability will have the greatest effect on the system

Maintainability allocations provide a "budget" of maintainability values which, if met, will ensure with a high degree of confidence that the system level requirements will be achieved. This budget is the standard against which subsequent maintainability predictions and demonstrated (i.e., measured) values are compared. The allocation of maintainability requirements must be completed and the results made available to the designers and any subcontractors early in the program.

Allocation is an iterative process. The feasibility of achieving the initial set of allocated values must be evaluated and, if the allocated values are not reasonable, the allocation must be revised.

One final note regarding allocations. As discussed thus far and will be shown in the specific methods that follow, the maintainability values allocated to subsystems, components, etc. are expressed in the same term as used for the product (MTTR, for example). However, an item may simply be removed and replaced to repair the product (see 4.3.1.1). Repair of the item itself would then be done off the product. For example, if an aircraft (the product) had an engine fail internally, the engine would be removed and replaced. It then would be sent to the engine shop or the engine manufacturer for repair. For complex products that are mobile (wheeled and tracked vehicles, aircraft, railroad engines and cars, and, to a lesser extent, ships), many "repairs" consist of removing and replacing the failed item or component. Table X shows the types of repairs and maintenance that are made on the product (i.e., in-place).

TABLE X. Typical Types of "In-place" Repair and Maintenance.

Type of Maintenance Action	Performed On
Repair	<ul style="list-style-type: none"> • Hydraulic, pneumatic, lubrication, and fuel lines • Electrical cables and wiring • Structural components • Control cables
Calibration & adjustments	Subsystems, components, or items
Fueling and servicing (Includes lubrication)	Product, components, items

4.4.1.6.2.1 Failure Rate Complexity Method. In this method, the most stringent maintainability requirements (that is, the lowest MTTR values) are allocated to the subsystems and components having the lowest reliability; and conversely, the least stringent maintainability

requirements are allocated to the subsystems components having the highest reliability. The assumption is that the most complex items will have the highest failure rates. For that reason, the method is referred to as the Failure Rate Complexity Method (FRCM). The procedure for the method is as follows:

- Step 1. Determine N_i , the number of each item in the product for which the allocation is being made.
- Step 2. Identify λ_i , the failure rate for each item (constant failure rate is assumed).
- Step 3. Multiply λ_i by N_i to find C_{fi} , item is contribution to total failure rate.
- Step 4. Express each item's MTTR, M_i , as the product of (λ_H / λ_i) and M_H , where H is the item having the highest failure rate.
- Step 5. Multiply each result from Step 4 by the corresponding λ_i . The result is C_{Mi} .
- Step 6. Using equation 6, solve for the MTTR of the item having the highest failure rate.

$$MTTR_{Product} = \frac{\sum_i C_{Mi}}{\sum_i C_{fi}} \tag{Equation 6}$$

where $C_{Mi} = M_i C_{fi}$

- Step 7. Solve for the MTTR of the other items by multiplying the MTTR found in Step 6 by λ_H / λ_i .

Table XI illustrates an example of maintainability allocation using the FRCM, for the subsystems shown in Figure 17. The same method was used to allocate the MTTRs found for subsystem B to its components.

TABLE XI. Allocation Using Failure Rate Complexity Method.

Item	Step 1. Determine No. of Items per Product (N_i)	Step 2. Identify Failure Rate λ_i $\times 10^{-3} f/H$	Step 3. Calculate Contribution to Total Failure Rate $C_{fi} = N_i \lambda_i$ $\times 10^{-3} f/H$	Step 4. Express each MTTR (M_i) as $(\lambda_H / \lambda_i) \times M_H$	Step 5. Calculate Contribution to System MTTR $C_{Mi} = M_i C_{fi}$
A	1	5	5	M_a	$5 M_a$
B	1	1.111	1.111	$4.5 M_a$	$5 M_a$
C	1	.833	.833	$6 M_a$	$5 M_a$
			$\sum C_{fi} = 6.944$		$\sum C_{Mi} = 15 M_a$
Step 6. Solve for M_a					
$MTTR_{Product} = \sum C_{Mi} / \sum C_{fi} \Rightarrow 1.44 = 15 M_a / 6.944 \Rightarrow M_a = .67 \text{ hours}$					
Step 7. Solve for M_b and M_c					
$M_b = 4.5 M_a = 3 \text{ hours} ; M_c = 6 M_a = 4 \text{ hours}$					

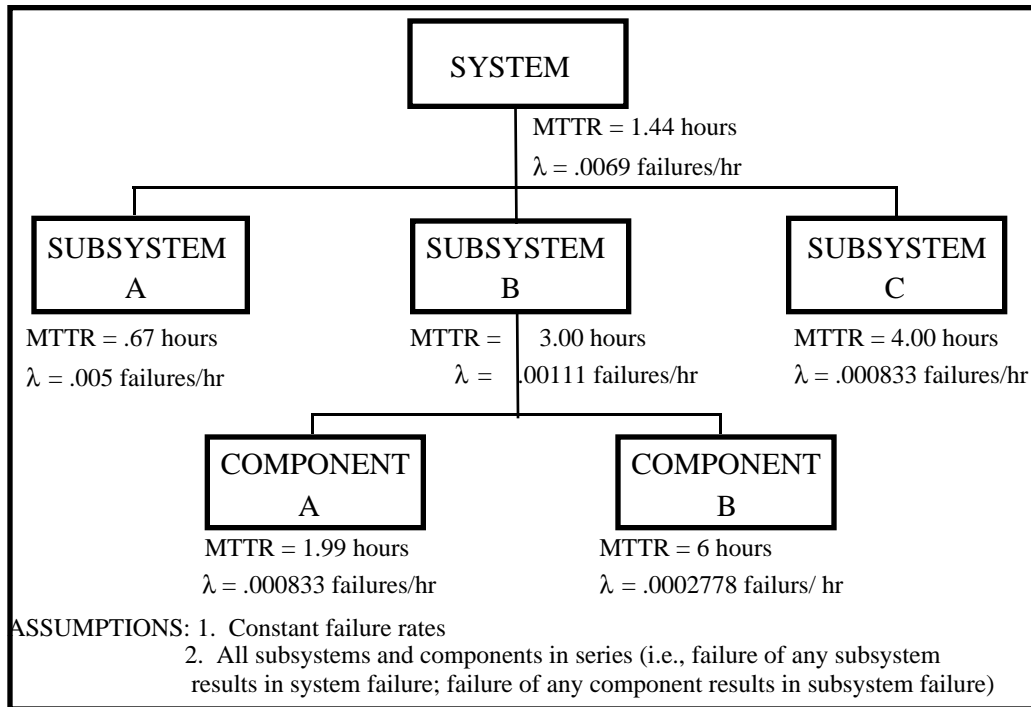

FIGURE 17. Example of Maintainability Allocation.

4.4.1.6.2.2 Variation of the Failure Rate Complexity Method. A method used by Blanchard and Fabrycky in their text¹⁶ is a variation of the Failure Rate Complexity Model. In this approach, an initial MTTR is assumed for each item and the product-level MTTR, M_{Product} , is calculated using equation 5. If the result is equal to or less than the required M_{Product} , the allocation is complete. If it is not, then new values of each item's MTTR are selected and the process repeated until the calculated M_{Product} is equal to or less than the required M_{Product} . The initial values for the items' MTTRs can be selected based on similar items already in use or engineering estimates.

4.4.1.6.2.3 Statistically-Based Allocation Method. A well-documented, statistically-sound methodology for performing a maintainability allocation may be found in IEC 706-6, "Guide on Maintainability of Equipment - Part 6: Section 9: Statistical Methods in Maintainability Evaluation," Annex A, "Maintainability Allocation." The key underlying assumption is that, within a product, item maintainability is inversely proportional to item complexity.

This method is based upon the frequently used assumption that the maintenance times, and especially the active corrective maintenance part of them, which is generally under the control of the supplier, can be adequately described by a log-normal distribution with mean active corrective maintenance time (MACMT) and 95th fractile maximum active corrective maintenance time (ACMT₉₅; also called $M_{\text{Max}}(95)$). Active corrective maintenance times longer than ACMT₉₅

¹⁶ Blanchard, Benjamin S. and Wolter J. Fabrycky, "Systems Engineering and Analysis," Prentice-Hall, Englewood Cliffs, NJ, 1981.

are also determined so as to provide the complement to the accumulated mean active corrective maintenance time specified for the item.

4.4.1.6.2.4 Equal Distribution Method. This method is applicable when the items have equal, constant failure rates. The Equal Distribution method simply allocates the product-level value of maintainability to each lower indenture item. As shown in Table XII for the product depicted in Figure 17, using the product-level MTTR for each item does indeed result in an allocation that supports the product-level requirement. The assumption underlying this method is that repair times are unrelated to the failure rate (i.e., MTTR is not affected by complexity). The method is identical in principle with the Equal Distribution method used for reliability allocations.

TABLE XII. Example of Equal Distribution Method.

Item	No. of Items per Product (N_i)	Item Failure Rate λ_i $\times 10^{-3}$	Contribution to Total Failure Rate $C_{fi} = N_i \lambda_i \times 10^{-3}$	MTTR (M_i) (each set equal to product-level M)	Contribution to System MTTR $C_{Mi} = M C_{fi}$
A	1	5	5	1.44	7.2
B	1	1.11	1.11	1.44	1.6
C	1	.833	0.833	1.44	1.2
			$\Sigma C_{fi} = 6.943$		$\Sigma C_{Mi} = 10$
CHECK					
MTTR _{Product} = $\Sigma C_{Mi} / \Sigma C_{fi} = 10/6.943 = 1.44$ hours					

4.4.1.6.3 Maintainability Assessment. Periodically, assessments are made of the quantitative and qualitative maintainability characteristics of the design. In making these assessments, terms and parameters must be carefully defined.

Maintainability terms and parameters are many and varied, to the extent that maintainability engineers sometimes use different terms for the same measure. Therefore, all parties involved in the task must understand and track, for example, how the time intervals are measured and which type of activities; preventive, corrective or both are included and which are excluded. If units or categories get mixed, the results of the computations will be inconsistent and will have no effective meaning or use. For further discussion of other data considerations see section 4.5, "Data Collection and Analysis."

4.4.2 Test. In the development of any product, and prior to release to the customer, testing of the product is conducted for several purposes. Tests are conducted to:

- Verify that the hardware and software meet product performance specifications
- Validate that the design is reliable and maintainable
- Improve product quality by uncovering design and manufacturing process problems, determining the root causes of problems, and subsequently introducing fixes

While we cannot develop a product without performing some kind of testing, it is often difficult to determine how much testing should be done, given the constraints of limited test samples,

time, and budget. Given these factors, it becomes important to develop a well coordinated and conceived product development and evaluation test plan. This plan should include input from all disciplines, including maintainability. Without an integrated approach to testing, certain risks and consequences can ensue, as shown in Table XIII.

TABLE XIII. Risks and Consequences of a Testing Approach That is Not Integrated.

Risks	Consequences
Critical tests are omitted	Design shortcomings may appear after the customer assumes ownership of the product
Tests are duplicated	Development costs increase and schedules are affected
Test resources are inadequate	Tests are delayed, results are incomplete, results are inaccurate or invalid, faults are missed, and product performance suffers
Test schedules are not coordinated	Inadequate time for testing, tests occur in wrong sequence, tests compete for critical test equipment, test requirements are not met, etc.
Schedules are milestone-oriented	Test results seem to confirm progress but do not result in needed product design improvements

Because testing budgets may be limited, it may be necessary to validate, refine and demonstrate a product's maintainability, using the results of tests performed for other reasons. If this is to be the case, the maintainability engineer must be involved in the test planning process, such that provisions can be made to collect maintainability-related information that will assist in the evaluation of the product maintainability design.

4.4.2.1 Objectives. There are two primary objectives for performing a test on a product:

- (1) to validate and refine the design (and the design approaches and tools)
- (2) to determine if a specification has been met.

In both cases, several tests may be required to meet these objectives. A maintainability test objective may be to validate that a product's subassemblies can be removed and replaced by a person using a defined set of tools. Another test may be performed to determine if the specification for MTTR is being achieved. In either case, planning must be accomplished early in development to determine if a formal maintainability test will be performed. If not, then a well coordinated data collection program must be initiated that solicits information important to maintainability. For example, if a reliability growth test is to be conducted, then data should be collected on fault detection and isolation times and diagnostic efficiency when failures occur that must be fixed. In addition, data should be collected on ease of maintenance during removal and replacement of the failed items. Formal maintainability testing should be planned using standardized methods such as those found in Appendix B, Test Methods. Appendix B was based, in part, on MIL-STD-471A, Maintainability Verification, Demonstration, and Evaluation.

4.4.2.2 Types of Testing. In general, testing related to maintainability can be grouped into five basic areas: functional, performance, verification, demonstration, and evaluation. Functional testing is performed to verify that a product, or product function, is behaving as intended. Such testing typically involves applying a known stimulus or set of stimulus to the test item and comparing the item response to a known response or set of responses.

Performance testing goes beyond functional testing to verify that the level of performance of the product functions meet the requirements. It is not sufficient, for example, to verify that for a given input signal, the product provides the right kind of output signal; the characteristics of the signal (amplitude, noise level, and so forth) and the reliability, maintainability, safety, and so forth of the product must meet the requirements. Special types of performance testing are design limit tests, life tests, software tests, electromagnetic interference (EMI) tests, and reliability growth tests.

Functional testing and performance testing are performed throughout various phases of product development and may include the use of models, simulations, testbeds, and prototypes or Full Scale Development models of the product. While such testing is almost always performed as part of the product design and development process, testing of the maintainability features of the product design, such as diagnostics, must also be planned for in a similar fashion. Diagnostic and other maintainability performance testing must be an integral part of all testing. This is important to evaluate performance, uncover deficiencies and implement corrective action while the product is still in development.

Verification testing is performed on a continuous basis throughout product development to determine the accuracy of and update the analytical data obtained from engineering analysis. Verification is typically performed prior to any planned demonstration or evaluation test to provide assurances that the maintainability of the product can be achieved and demonstrated. Note that all kinds of test data collected, such as from a functional test of the diagnostics, should be used for verification of maintainability analyses and requirements.

Demonstration testing is usually a formal process conducted by the product developer and end customer to determine whether specific maintainability requirements that have been specified have been achieved. Such testing will involve development of a formal test plan, using defined methods of analysis to determine compliance. Details of demonstration test plans and procedures, as well as verification and evaluation test data can be found in Appendix B, Test Methods.

Evaluation testing is the process to determine, at all levels of maintenance and product design, the impact of the operational and maintenance and support environments on the maintainability parameters of the product. Such testing should involve performance of defined maintenance tasks in the product's actual use environments. Maintainability evaluation testing, as with other forms of testing, should be integrated with testing designed to evaluate other product parameters. Evaluation testing is one area that stands to benefit from virtual reality capabilities. Such capabilities would allow the testing of some maintenance tasks (such as manual ones) in a simulated usage environment, rather than the actual one. Some obvious cost savings are possible with this approach.

4.4.3 Statistical Distributions Used in Maintainability Models. The distributions most commonly used in maintainability analysis are the normal, lognormal, and exponential. Just as the exponential distribution has been the one most widely used in reliability analysis of products,

the lognormal distribution is the one most commonly used in maintainability analysis of products. However, use of other distributions such as the Weibull and gamma is also possible, depending upon the analysis of the data and the use of "goodness of fit" tests.

4.4.3.1 Lognormal Distribution. The lognormal is the most commonly used distribution in maintainability analysis because it is considered representative of the distribution of most repair times. It applies to most maintenance tasks and repair actions comprised of several subsidiary tasks of unequal frequency and time duration.

The probability density function is given by:

$$g(t = M_{ct_i}) = \frac{1}{t\sigma_{t'}\sqrt{2\pi}} \exp \left[-\frac{1}{2} \left(\frac{t' - \bar{t}'}{\sigma_{t'}} \right)^2 \right] \quad (\text{Equation 7})$$

where:

$t = M_{ct_i}$ = repair time from each failure

$\sigma_{t'}$ = standard deviation of repair times =

$$\sqrt{\frac{\sum (\ln M_{ct_i})^2 - \left(\frac{\sum (\ln M_{ct_i})}{N} \right)^2}{N-1}} \quad (\text{Equation 8})$$

$t' = \ln M_{ct_i} = \ln t$

$\bar{t}' = \frac{\sum t_i'}{N} = \frac{\sum \ln M_{ct_i}}{N}$

N = number of repair actions

The mean time to repair is given by:

$$\text{MTTR} = \overline{M_{ct}} = \bar{t} = \int_0^{\infty} t g(t = M_{ct_i}) dt \quad (\text{Equation 9})$$

$$= \exp \left[\bar{t}' + \frac{1}{2} (\sigma_{t'})^2 \right] \quad (\text{Equation 10})$$

The median time to repair is given by:

$$\tilde{M}_{ct} = \exp(\bar{t}') \quad (\text{Equation 11})$$

The maximum time to repair is given by:

$$M_{Max_{ct}} = antiln \left[\bar{t}' + z(t'_{1-\alpha}) \sigma_{t'} \right] \tag{Equation 12}$$

where $z(t'_{1-\alpha})$ = the value from the normal distribution function corresponding to the percentage point $(1-\alpha)$ on the maintainability function for which $M_{Max_{ct}}$ is defined. Most commonly used values of $z(t'_{1-\alpha})$ are shown in Table XIV.

TABLE XIV: Values of $z(t'_{1-\alpha})$ Most Commonly Used in Maintainability Analysis.

$(1-\alpha)$	$z(t'_{1-\alpha})$
0.80	0.8416
0.85	1.036
0.90	1.282
0.95	1.645
0.99	2.326

4.4.3.2 Normal Distribution. In maintainability, the normal distribution applies to relatively straightforward maintenance tasks and repair actions (e.g., simple removal and replacement tasks) which consistently require a fixed amount of time to complete. Maintenance task times of this nature are usually normally distributed, producing a probability density function given by:

$$g(t = M_{ct}) = \frac{1}{S_{M_{ct}} \sqrt{2\pi}} \exp \left[\frac{-(M_{ct_i} - \bar{M}_{ct})^2}{2(S_{M_{ct}})^2} \right] \tag{Equation 13}$$

where:

M_{ct_i} = repair time for an individual maintenance action

$\bar{M}_{ct} = \frac{\Sigma(M_{ct_i})}{N}$ = average repair time for N observations

$S_{M_{ct}} = \sqrt{\frac{\Sigma(M_{ct_i} - \bar{M}_{ct})^2}{N - 1}}$ = standard deviation of the distribution of repair times, based on N observations

N = number of observations

The mean time to repair (\bar{M}_{ct}) is given by:

$$\bar{M}_{ct} = \frac{\sum M_{cti}}{N} \quad (\text{Equation 14})$$

The median time to repair (\tilde{M}_{ct}) is given by:

$$\tilde{M}_{ct} = \frac{\sum M_{cti}}{N} \quad (\text{Equation 15})$$

which is equal to the mean time to repair because of the symmetry of the normal distribution.

The maximum time to repair is given by:

$$M_{\text{Max}_{ct}} = \bar{M}_{ct} + z(t_{1-\alpha}) S_{M_{ct}} \quad (\text{Equation 16})$$

where:

$z(t_{1-\alpha})$ = value from normal distribution function corresponding to the percentage point $(1-\alpha)$ on the maintainability function for which $M_{\text{Max}_{ct}}$ is defined.

Values of $z(t_{1-\alpha})$ as a function of $(1-\alpha)$ are shown in Table XIV.

4.4.3.3 Exponential Distribution. In maintainability analysis, the exponential distribution applies to maintenance tasks and maintenance actions for which completion times are independent of previous maintenance experience (e.g., substitution methods of failure isolation in which several equally likely alternatives are available and each alternative is exercised, one at a time, until the one which caused the failure is isolated), producing a probability density function given by:

$$g(t = M_{ct}) = \frac{1}{\bar{M}_{ct}} \exp \left(-\frac{M_{cti}}{\bar{M}_{ct}} \right) \quad (\text{Equation 17})$$

The method used in evaluating the maintainability parameters is similar to that used for analyzing reliability with exponential times-to-failure. The fundamental maintainability parameter is the repair rate, μ , which is constant for the exponential distribution. It is the reciprocal of \bar{M}_{ct} , the mean-time-to-repair (MTTR). Thus, another expression for $g(t)$ in terms of μ , the repair rate, is:

$$g(t) = \mu e^{-\mu t} \quad (\text{Equation 18})$$

The maintainability function, $M(t)$, is given by:

$$M(t) = \int_0^t g(t) dt = \int_0^t \mu e^{-\mu t} dt = 1 - e^{-\mu t} \quad \text{(Equation 19)}$$

The MTTR is given by:

$$\bar{M}_{ct} = \frac{1}{\mu} = \frac{\sum M_{cti}}{N} \quad \text{(Equation 20)}$$

If the maintainability function, $M(t)$, is known, the MTTR can also be obtained from:

$$MTTR = \bar{M}_{ct} = \frac{-t}{\{\ln[1 - M(t)]\}} \quad \text{(Equation 21)}$$

The median time to repair \tilde{M}_{ct} is given by:

$$\tilde{M}_{ct} = 0.69 \bar{M}_{ct} \quad \text{(Equation 22)}$$

The maximum time to repair is given by:

$$M_{Max_{ct}} = k_e \bar{M}_{ct} \quad \text{(Equation 23)}$$

where:

k_e = value of M_{ct_i} / \bar{M}_{ct} at the specified percentage point α on the exponential function at which $M_{Max_{ct}}$ is defined.

Values of k_e are shown in Table XV.

TABLE XV: Values of k_e for Specified α .

α	k_e
95%	3.00
90%	2.31
85%	1.90
80%	1.61

4.5 Data Collection and Analysis. Valid data are important to every aspect of a maintainability program. These data include data resulting from design analyses as well as data generated from maintenance actions both during development and during a product's useful life phase. For design, data are required for maintainability predictions, demonstration test development, maintainability model verification (including diagnostics), and as input to simulation models. Maintainability information collected from the field is important to determine actual performance, capture lessons learned, and to identify where improvements are required for product upgrades or new product development. Maintainability data analysis techniques are also important to understand so that effective and efficient use of the information can be made.

Because of the importance of data to the success of product development, careful consideration should be given to the kinds of data required, where to obtain the data, and how to analyze the data in a way that is cost-effective.

4.5.1 Types of Data. The types of data to be collected can be broadly categorized as development data and field data.

4.5.1.1 Development Data. Development data include built-in-test (BIT) effectiveness information, such as fault detection and fault-isolation performance, and repair data. Whenever failures occur during development or demonstration testing (such as a reliability demonstration test), the results of fault isolation, such as time to isolate, ambiguity levels, and resources expended should be recorded. Any problems noted during troubleshooting of failures should also be recorded. Such information should be tied to the failure information, such as failure mode and cause, so that the effectiveness of any diagnostic elements in correctly detecting and isolating the fault can be determined. If the fault was a false alarm detected by system BIT, this fact should also be recorded. If such a problem continues to exist, then an analysis will be required to determine why the problem exists and how it can be fixed. In addition to diagnostic data, data on repair actions should also be collected. Once again, information on repair times, resources and any noted problems should be collected. All data should continuously be reviewed to determine if corrective actions are necessary to improve maintainability. These reviews should be done in conjunction with and as part of a failure reporting, analysis and corrective action system, or FRACAS. Although most associated with reliability programs, FRACAS is a closed-loop data reporting system for the purpose of systematically recording, analyzing, and resolving equipment reliability AND maintainability problems and failures.

To benefit from a FRACAS, the maintainability manager must closely coordinate with the reliability manager to ensure that maintainability data are incorporated into a FRACAS data collection form. An example of a FRACAS form, showing blocks for maintainability data (highlighted) is presented as Figure 18. In addition to collecting maintainability data resulting from actual failure occurrences, information from maintainability simulations should also be documented. This information would include BIT coverage values derived via fault simulations and the results of simulating product repair procedures.

FRACAS FORM			
1. Failure Report By:	2. Project RAM Manager	3. Initial Report Date:	
4. Failure Analysis By:	5. Report No.	6. Final Report Date:	
7. Incident Classification: Relevant Nonrelevant (Check only one)			
<input type="checkbox"/> Independent Failure	<input type="checkbox"/> Accident/Mishandling Failure		
<input type="checkbox"/> No-Fault Verified	<input type="checkbox"/> Externally Applied Overstress		
<input type="checkbox"/> Intermittent/Unverified	<input type="checkbox"/> Beyond Replacement Time		
<input type="checkbox"/> Redundant System Failure	<input type="checkbox"/> Secondary Failure		
<input type="checkbox"/> Inadvertent Operator Failure	<input type="checkbox"/> Test Initiation		
8. Identify Unit and Test Run Number for This Event: _____ Run No. _____			
<input type="checkbox"/> Unit XYZ	<input type="checkbox"/> Unit ABC	<input type="checkbox"/> Unit XXX	<input type="checkbox"/> Unit YYY
<input type="checkbox"/> Unit ZZZ	<input type="checkbox"/> Unit AAA	<input type="checkbox"/> Unit BBB	
9. Describe Component Identification:			
A. Next Higher Level System Name _____ WBS No. _____ Serial No. _____ Part/Dwg. No. _____			
B. Failed Level Component Name _____ WBS No. _____ Serial No. _____ Part/Dwg. No. _____			
10. Start Time for Component Operation			
Yr	Mo	Day	Hr Min Sec ETI CYC
11. Stop Time for Component Operation			
Yr	Mo	Day	Hr Min Sec ETI CYC
12. Describe Symptoms and Method of Early Fault Detection and Isolation			
13. Document Failure Detection/Isolation Effectiveness (e.g., actual fault correctly detected, fault isolation to ambiguity group size of _____, etc.):			
14. Document Fault Isolation Time:			
15. Describe Failure Mode, Cause of Failure, Findings of Failure Analysis:			
16. End Effect of the Failure: <input type="checkbox"/> Module Catastrophic <input type="checkbox"/> Module Derate <input type="checkbox"/> Module Incipient			
17. Describe Repair Action, Any Problems (e.g., Accessibility, Difficulties in Removal or Replacement), Parts Repaired, Replaced, or Serviced			
18. Corrective Action, Responsible Individual:			

FIGURE 18. Example FRACAS Form.

4.5.1.2 Field Data. Field maintainability data include all operational information relevant to all manual or automatic actions taken to retain an item in or restore it to an operable condition. These data include repair time (including diagnostics), number and skill level of personnel required, environmental conditions, and failure disposition (e.g., no fault found, relevant failure, independent failure, etc.). The information should also be classified according to the maintenance actions taken (i.e., preventive or corrective).

When designing a field data collection system, or when trying to improve upon an existing system, it is important to minimize any bias that can be introduced by those personnel collecting the data. Therefore, keep in mind that operations and maintenance personnel should be trained on the data collection system, and its importance to tracking performance, identifying problems, and improving the product and product support characteristics. As an example of the data fields that exist in a current maintenance database, Table XVI shows the database structure from an Air Force system developed for a specific product, in this example an electronic warfare system.

Other categories of data that would be beneficial to collect include information on the maintenance support conditions. As noted previously, operational maintainability may not be determined solely by inherent maintainability, but by logistical factors. Therefore, information to be collected should include shortages in spares (due to inadequate initial provisioning, long pipeline times, etc.), test resources, and human resources. Such data are important to determine why a product's maintainability, as measured in the field, may not be meeting the values expected based on design data. In addition to maintenance data collected as the result of performing a maintenance action, other forms of data include customer satisfaction surveys. Such surveys may include perception of product performance and dependability, service support performance, agreements with advertised claims, maintainability performance, and maintenance and assistance effectiveness. More detailed information on data collection systems and data requirements can be found in IEC Standard 300-3-2: "Dependability Management - Part 3: Application Guide - Section 2: Collection of Dependability Data from the Field," and in IEC Standard 706-3, "Guide on Maintainability of Equipment - Part 3: Sections Six and Seven: Verification and Collection, Analysis, and Presentation of Data."

4.5.2 Sources of Data. Maintainability-related data may be obtained from several different types of sources. Some potential sources of maintainability data include:

- Historical data from similar items
- Item design and/or manufacturing data
- Data recorded during item demonstration
- Field use data

The data may be expressed in a variety of terms. These include observed values or modified values (true, predicted, estimated, extrapolated, etc.) of the various maintainability measures. Some precautions are therefore necessary regarding the understanding and use of such data.

TABLE XVI. Example Data Fields From an Existing R&M Data Base.

Field Name	Description of Field
Job Control Number	Documents year and day of action and assigns job control number
Work Center	Primary Work Center
Serial Number	Serial number of component maintenance is being reported against. Serial number must be input if maintenance action involves serially controlled or time change item (i.e., If the item being removed from an aircraft, the aircraft serial number is input into this field). Otherwise may be blank.
MDS	Mission/Design/Series data. If data pertains to all equipment of a particular mission/design/series, the field is left blank.
SRD	Standard Reference Designator. The code can be used to designate whether an item is Mission Capability (MICAP) and/or MDS reportable. This field may be prefilled if maintenance action is against a component which is not directly related to an ID numbered piece of equipment and has an established event ID. Otherwise the SRD of equipment end item the component is used on is entered. This field may be blank.
Sortie No.	Sortie Number
FSC	Federal Stock Class. The federal supply classification code of the item being modified or removed
Part/Lot No.	The part or lot number of the item being modified or removed
Operating Hours	For items with an Elapsed Time Indicator (ETI), the number of hours indicated. Otherwise, left blank.
Serial No.	Serial number of the item removed.
Tag No.	Tag Number that is prepared and attached to the removed item.
Discrepancy	Free test narrative that describes the discrepancy that caused the reported maintenance event. This field may be prefilled if the maintenance action is against a previously established event ID.
Corrective Action	Narrative that describes the detailed actions taken to correct the problem
Type Maint	Type Maintenance Code. This field is a one character field used to identify the type of work that was accomplished, such as scheduled or unscheduled maintenance. TMs can be found in the WUC manual. (Y or S = transient aircraft)
Comp Pos	Component Position. If installation involves the installation, removal, or maintenance of installed engine on any component WUC item within systems 21-24 or 27, enter component position. May be blank
WUC	Work Unit Code. Five character field designed to provide a quick reference to identify system, subsystem, and component relationships within end items.
Action Taken	One character field used to identify the maintenance action that was taken such as the removal or replacement of a component. Action taken codes are standard for all equipment and are listed in the WUC manuals.
When Disc	When discovered. One character field used to identify when a defect or maintenance requirement was discovered. When discovered codes are listed in the WUC manuals.
How Mal	How Malfunction Code. The How Mal code consists of three characters and is used to identify the nature of the defect and not the cause of the discrepancy. May be blank.
Start	Date/hour when a job is initiated.
Stop	Stop day/stop hour. Job stop time. Typically only the number of hours taken to complete a job is available. Hours are input in hours and tenths (i.e., XXX.X). Cannot be blank.
Crew Size	Crew Size (0 to 9) can't be blank. Reflects the number of individuals or crew from the same work center (same category of labor) that actually participated in the maintenance action during the period of time documented identifying the action. When the crew size exceeds nine an additional entry is made to reflect the additional number of technicians.
Cat Lab	Category of Labor (1 to 6), can't be blank. Used to differentiate between the types of man-hour expenditures. If all members of a maintenance crew are the same category of labor then only one entry is required. If more than one category of labor (military and civilian) is performing the same maintenance task, or if overtime hours are expended an entry is required to reflect each category of labor.
Qty	Quantity of items on a given line removed during the repair process.

Historical data - The origin of the historical data (e.g., field operation, repair shop and software center) and the item on which such data are based should be described and the reasons why and how they apply to the current item should be addressed. The methods used to collect the data, together with the training and skill levels of maintenance personnel involved, should also be clearly stated. Discrepancies which might affect the applicability of historical data to the item under consideration should be specifically addressed.

Historical data is used primarily during the concept definition phase and for specification requirement generation purposes. In the later phases of the item life cycle, historical data may be considered in relation to actual data obtained for the current item. They can also serve as an additional source of information for maintainability verification.

Item design/manufacturing data - When maintainability-related data are obtained through the use of design analysis or prediction, or from data generated during the design phase or the manufacturing phase (e.g., development tests, production or assembly operations), the methodology used needs to be clearly identified. A discussion may also be needed to explain how the specific method was selected and applied. Any possible resulting limitations in data accuracy needs to be noted. Design/manufacturing data may be used as the basis for:

- Item qualification and acceptance (with regard to maintainability requirements)
- Review of the relevancy of historical data and the validity of previous maintainability assessments

Item demonstration data and/or field data - Maintainability-related data may also be obtained from formal or informal demonstration tests on mock-ups, prototypes or production equipment in either a true or a simulated environment. Data may also be generated during actual item use (e.g., support center, repair work shop, field operations, etc.). The methods for selecting specific maintenance actions, data monitoring and recording techniques thus need to be described. The skill level of maintenance personnel and the specific equipment training they have received should be noted. The feedback of item demonstration data and field data is the primary means for sustaining engineering activities during the in-service phase of the item life cycle.

4.5.3 Data Analysis Techniques. The precise form of statistical analysis of data is specific to each use and can be a complex and time-consuming process. It should be carried out by an experienced analyst who can properly assess the information required to be extracted from the raw data.

Data (including maintenance data) are frequently analyzed to obtain statistical inferences regarding a given population of data. Statistical inference, is the process of drawing conclusions about an entire population of similar objects, events, or tasks, based upon a sample of a few.

Two basic approaches to statistical inference are mainly used¹⁷ (either or both approaches may be used in the analysis of maintenance/maintainability data¹⁸):

- *Parametric* - which is primarily concerned with inference about certain summary measures of distributions (mean, variance, etc.). This approach is based on explicit assumptions about the normality of population distributions and parameters.
- *Distribution* - which is concerned with inference about an entire probability distribution, free of the assumptions regarding the parameters of the population sampled.

Meaningful data handling and its subsequent evaluation also require some prior investigation of the process generating the data. Different sets of data available on an item may be combined, provided that the same selection criteria have been applied to each set. The choice of appropriate methods of data evaluation may be influenced by such factors as possible time-dependency of the process or more than one cause relating directly to the data.

Any peculiarities in the data collection scheme should be taken into account in developing the data and in the analytical process. The analyst should identify any data falling outside a pre-set range. Acceptance or rejection criteria should be explicitly validated.

Frequently one of a number of types of statistical distribution will underlie the collected data. Three principal methods are available to identify a particular underlying distribution:

- Engineering judgment, based upon an analysis of the physical process generating the data
- Graphical methods using special charts, leading to the construction of nomographs
- Statistical tests, such as the Chi-square and goodness of fit, providing a measure of the deviations between the sample and the assumed distributions

4.5.3.1 Data Used Explicitly for Compliance Verification. When maintainability-related data is to be used for compliance testing and for determination testing, the analysis procedures used need to be considered very carefully and discussed in detail in any subsequent test report.

Matters of importance include:

- Data Editing/Data Transposition
- Distribution Analysis

¹⁷ Hays, W. L. and Winkler, W. L. "Statistics-Probability, Inference and Decision", Holt, Reinhart and Winston, New York, 1971

¹⁸ Knezevic, J. "Effective Analysis of Existing Maintainability Data", SAE Communications in RMS, Volume 2/Number 1, January 1995

- Parameter Computation
- Presentation of Results

a. *Data Editing/Data Transposition* - Actions taken to assure the accuracy, completeness and validity of the data should be described. If any censoring is performed, the rules and reasons for performing the censoring should be presented. If data are transposed from one form to another (e.g., from a linear to a logarithmic scale), the reason and justification for such a transposition should be clearly stated.

b. *Statistical Distribution Analysis* - If the data are to be analyzed statistically, it is usually necessary to determine the underlying distribution. The most commonly used distribution functions in maintainability are: the log-normal distribution and the multimodal distribution (in special cases only). The method of testing the distribution assumption should be described, with the reasons for that specific selection. Common methods used in maintainability analysis include the χ^2 (chi-square), Kolmogorov-Smirnov and various graphical tests. The Kolmogorov-Smirnov (also known as *d*-test) is the most frequently used method for distribution testing. Its usage, relative to maintainability data, is described in detail in IEC 706-6, "Guide on Maintainability of Equipment - Part 6: Section 9: Statistical Methods in Maintainability Evaluation," Annex C, "Kolmogorov-Smirnov Distribution Testing." For other possible statistical analysis methods pertinent statistical textbooks should be consulted.

c. *Parameter Computation* - The basis for computing all maintainability parameters to be presented should be clearly stated. If selected parameters are to be computed on a cumulative or interval basis, the method to be used should be detailed. If maintainability mathematical models are to be used, they should be fully described.

d. *Presentation of Results* - When the results are to be presented, all conditions needed for their understanding and use should be clearly stated. These conditions include the purpose of the data collection scheme, especially with respect to type and variation of the data chosen. Circumstantial information should also be provided, such as time (e.g., busy hours), locations (e.g., geographic conditions) and the current duration of the data-collection scheme. Particular situations which may limit the data application and use should be indicated (for example, any difficulties encountered, assumptions, or incompleteness of data).

Consideration should also be given to the form of presentation. A condensed form (for example, diagrams, histograms, graphical presentations) may be more appropriate than detailed numerical listings.

4.5.4 Uses of Data

Data is always the key to the proverbial management sequel, namely - Where are we now? - Where do we want to go? - How do we get there?

Maintainability data frequently answers the first question - *Where are we now?*

Subcontractors and suppliers frequently have little, if any, maintainability data. In fact, unless they have previously had to deal specifically with maintainability requirements, they often have **no information** about the maintainability of the items which they have delivered in the past. Data collection is not a strong point in many industrial companies. Many are interested in closing their contractual responsibilities at the end of the warranty period rather than motivated for setting up an after-contractual data follow-up procedure with their customers. The practical consequence of this philosophy is that collection of performance data on similar systems does not become a priority task - until the early phases of a new program development.

Unless we know where we are - how can we know where we want to go?

Thus, subcontractors and suppliers often are reluctant to accept maintainability targets without knowing the exact maintainability demonstration procedure.

Building of a corporate maintainability data base is the key, the starting point.

Such a data base (grounded upon actual product experience) is an important resource, a definite corporate asset. It can prove to be extremely helpful for subsequent developments.

With modern spread sheet and data-base programs it is relatively easy to build such a data bank based upon actual experience with a specific product. These data can then be used, for example, to customize and enhance an existing automated prediction software program and thus provide a more accurate maintainability prediction on a subsequent development item.

A closed-loop failure reporting system (FRACAS) addresses the third question - How do we get there?

We get there - by first identifying, and then resolving, each problem one by one, as they are discovered. Again, the data - which has been, or is being, collected - is the key.

Some of the specific benefits for such maintenance/maintainability data are:

- Determine compliance with specified maintainability requirements
- Provide logistics and support information
- Assess adequacy of support resources
- Determine personnel requirements
- Determine deficiencies in maintainability and provide a basis for corrective action
- Establish repair time histories and build a corporate maintainability data base
- Detect excessive preventive maintenance

This page has been left blank intentionally.

APPENDIX A

**ACQUISITION GUIDANCE, TEMPLATES FOR PREPARING MAINTAINABILITY
SECTION OF SOLICITATION, AND GUIDANCE FOR SELECTING SOURCES**

SECTION A. ACQUISITION GUIDANCE

Scope. This Appendix is an essential part of MIL-HDBK-470A. The information contained herein is intended for reference only. This Appendix is for guidance only and cannot be cited as a requirement. If it is, the contractor does not have to comply.

Defense Acquisition Reform

Actions taken by the Secretary of Defense starting in 1994 significantly changed the way that the Department of Defense (DoD) and military departments contract for products.

1. Background. On June 29, 1994, Secretary of Defense William Perry issued a five-page memorandum, "Specifications & Standards - A New Way of Doing Business." The intent of the memorandum can be summarized as three "overarching" objectives:

- Establish a performance-oriented solicitation process
- Implement a document improvement process
- Create irreversible cultural change in the way DoD does business

The DoD is working to streamline the way in which procurement is managed and to adopt commercial practices whenever possible. It is reassessing and trying to improve the way it does business to decrease costs and increase customer satisfaction.

2. Specifications and Standards. Many months prior to the Perry memorandum of 29 June, a Process Action Team (PAT), chartered by Colleen Preston, Deputy Under Secretary for Acquisition Reform, and chaired by Darold Griffin, was tasked to review the system of military standardization documents and develop recommendations to:

- eliminate unnecessary and obsolete specifications and standards
- use performance specifications and standards
- use commercial standards and specifications to the greatest extent practicable
- encourage industry to propose alternative solutions to military specifications and standards
- and reduce paperwork

APPENDIX A

The preparing activities of military standardization documents have reviewed and will continue to review their documents and recommend disposition to the Secretary. The possible recommendations for disposition of a military specification or standard are:

- Retain as performance-based document (some revision may be necessary)
- Retain as interface standard
- Retain as test method standard
- Convert to handbook
- Inactivate for new design (reprocurement only)
- Delete in favor of a commercial item description
- Delete in favor of a non-government standard
- Cancel

As is explained in sections 4a and 4b of this Appendix, military standards and specifications may be cited for guidance in a Department of Defense solicitation but **may not** be cited as requirements unless a waiver is granted. Commercial standards may be cited for guidance. Although not specifically prohibited by policy at the time this handbook was written, commercial standards should not be mandated as requirements. Given the spirit of the new acquisition policy, mandating a commercial standard is no different than mandating a military standard. In either case, the procuring agency would be telling the bidding contractors what to do and how to do it, at least to the extent that the cited standard provides suggestions on the tasks and activities needed for maintainability. **The main objective of the new policy is to use performance specifications.** Only when performance specifications are inadequate for fully describing what the Government wants should commercial specifications and standards be considered. And only when commercial specifications and standards are inadequate should a waiver (see Section 4 for an explanation of which military documents require a waiver) to use a military specification or standard be considered.

3. Performance-based Specifications

a. A performance specification states requirements in terms of the required results and provides criteria for verifying whether or not the requirements have been met. Performance specifications do not state the methods for achieving the required results. They have the following characteristics:

- (1) Requirements should be stated quantitatively
- (2) Requirements should be verifiable
- (3) Interfaces should be stated in sufficient detail to allow interchangeability with parts of a different design.
- (4) Requirements should be material and process independent

APPENDIX A

b. There are four types of performance specifications: commercial item descriptions (CIDs), guide specifications (GSs), standard performance specifications (SPSs), and program-unique specifications.

- (1) Commercial Item Descriptions. An indexed, simplified product description prepared by the Government that describes, by performance characteristics, an available, acceptable commercial product that will satisfy the Government's needs. Guidance for CIDs is given in the General Services Administration Federal Standardization Manual (Chapter 6), in the Defense Standardization Manual, DoD 4120.3-M, and in DoD 5000.37-H. By definition, CIDs are used only to describe requirements in terms of function, performance, and essential form and fit requirements. CIDs are listed in the DoD Index of Specifications and Standards (DoDISS).
- (2) Guide Specifications. Guide specifications identify standard, recurring requirements that are common for like systems, subsystems, equipments, and assemblies. The format of a GS forces the user to tailor the document to the specific application. Guidance for GSs is in DoD 4120.3-M. GSs are listed in the DoD Index of Specifications and Standards (DoDISS).
- (3) Standard Performance Specifications. A specification that establishes requirements for military-unique items used in multiple programs or applications. MIL-STD-961 includes guidance on the format and content of SPSs.
- (4) Program-Unique Specifications. This type of specification, also called a system specification, establishes requirements for items used for a particular program or weapon system. Little potential exists for using these specifications in other programs or applications. They should be performance-based but may include a blend of performance and detail design requirements. They are restricted to items for which the preceding categories of performance specifications are not applicable.

c. Performance specifications are also categorized by the type of item being acquired. Those used to acquire materials are called material specifications, to acquire components are called component specifications, and to acquire systems are called system specifications. The Department of Defense has issued a guide to performance specifications, SD-15. Issued under the Defense Standardization Program, the guide covers the writing of performance requirements, standard performance specifications, guide specifications, and program-unique specifications. The preceding discussions under 3.a and 3.b are based on SD-15.

4. Other Standardization Documents.

a. Standards. There are four types of standards: interface, test method, manufacturing process, and practices.

- (1) Interface Standards. An interface standard is one that specifies the physical or functional interface characteristics of systems, subsystems, equipments, assemblies,

APPENDIX A

components, items, or parts to permit interchangeability, compatibility, or communications. Waivers **are not required** to use military interface standards as requirements in Department of Defense solicitations.

- (2) Test Method Standard. A test method standard is one that specifies procedures or criteria for measuring, identifying, or evaluating qualities, characteristics, and properties of a product or process. Military test method standards **may not** be cited as requirements in a Department of Defense solicitation unless a waiver is granted.
- (3) Manufacturing Process Standard. This type of standard states the desired outcome of manufacturing processes or specifies procedures or criteria on how to perform manufacturing processes. Military manufacturing process standards **may not** be cited as requirements in a Department of Defense solicitation unless a waiver is granted.
- (4) Standard Practice Standard. A standard practice standard is one that specifies procedures on how to conduct certain functions or operations. These procedures are not related to manufacturing processes. It has not yet been decided if standard practice standards may be cited as requirements in a Department of Defense solicitation without a waiver.

b. Handbooks. A handbook is a guidance document that provides engineering or technical information, lessons learned, possible options to resolve technical issues, classification of similar items, interpretive direction and techniques, and other types of guidance or information. The purpose is to help the customer or the seller to design, construct, select, manage, support, or operate systems, products, processes, or services. Military handbooks **may not** be cited as a requirement in a Department of Defense solicitation, contract, specification, standard, drawing, or any other document.

5. Overall Acquisition Policy and Procedures. The primary documents governing defense acquisition are DoD Directive 5000.1 and DoD Regulation 5000.2-R. Both documents were revised as a result of Defense Acquisition Reform. A third document, DoD 5000.2-M has been canceled. The revisions to 5000.1 and 5000.2-R (previously a DoD Instruction) incorporate new laws and policies, separate mandatory policies and procedures from discretionary practices, and integrate acquisition policies and procedures for weapon systems and automated information systems. In addition to the two documents, an Acquisition Deskbook is available to DoD procuring activities. The Deskbook is an automated repository of information consisting of a Desk Reference Set, a Tool Catalog, and a forum for information exchange. The Reference Set consists of mandatory Guiding Principles, discretionary Institutionalized Knowledge, and Sage Information (expert wisdom and lessons learned). Information about the Acquisition Deskbook can be obtained using the Internet: <<http://deskbook.osd.mil/deskbook.html>>.

The major themes of the new acquisition documents are teamwork, tailoring, empowerment, cost, commercial products, and best practices. In summary, (1) acquisition should be a team effort among all concerned in the process, (2) the acquisition approach for a specific system should be

APPENDIX A

tailored based on risk and complexity, (3) acquisition will be conducted with a customer focus, (4) cost will be an independent variable in programmatic decisions, (5) commercial products should be used when practical, and (6) acquisition is now more closely modeled on best commercial business practices.

The guiding principles of DoDD 5000.1 that are based on these themes are:

1. Translate Operational Needs into Stable, Affordable Programs

- Program stability
- Risk assessment and management
- Total systems acquisition
- Cost as an independent variable
- Program objectives and thresholds

2. Acquire Quality Products

- Event-oriented management
- Hierarchy of material alternatives
- Communication with users
- Competition
- Test and evaluation
- Independent assessments

3. Organize for Efficiency and Effectiveness

- Acquisition corps
- Teamwork
- Limited reporting requirements
- Automated acquisition information

DoD 5000.2-R also redefines the life cycle phases of a product. These phases do not necessarily occur in strictly a serial manner but may overlap. Preceding each phase is a decision milestone. Decision milestones are points in time when a decision is made to either enter the next phase or to stop the acquisition. These decisions are made on the basis of criteria defined in DoD 5000.2-R. The criteria for leaving one phase and being considered for continuation into the next phase are called exit criteria. An acquisition begins with the determination of a valid customer need.

A summary of the phases of acquisition as defined by DoD 5000.2-R are:

- Phase 0: Concept Exploration - Conduct competitive, parallel short-term studies to define and evaluate feasibility of alternative concepts and provide a basis for evaluating the relative merits of these alternatives at the next decision milestone

APPENDIX A

- Phase I: Program Definition and Risk Reduction - Define the program as one or more concepts, and pursue design approaches and technologies as warranted. Perform risk reduction activities including prototyping, demonstrations, and early operational assessments as appropriate
- Phase II: Engineering and Manufacturing Development - Translate the most promising design approach into stable, producible, supportable, and cost effective design; establish and validate a manufacturing capability; and demonstrate system capabilities through testing.
- Phase III: Production Fielding/Deployment and Operational Support - Produce systems (except software-intensive systems having no hardware components or those in ACAT 1A¹), conduct operational test and demonstrations, provide operational support, and incorporate modifications as needed

Although not referred to specifically as a phase, Demilitarization and Disposal is described by DoD 5000.2-R as those activities conducted at the end of a system's useful life. See Appendix E of MIL-HDBK-470A for a discussion of maintainability activities by phase.

6. Acquiring Maintainable Systems. Acquiring a maintainable product requires that certain key issues be addressed and that a sound solicitation package be developed. As has been stated previously, the solicitation must clearly define the maintainability requirements and provide sufficient information that suppliers responding to the solicitation can develop cost-effective, innovative approaches for meeting customer needs.

a. Key Issues. For any product, the key maintainability issues, from the customer's perspective, are:

- What measures of operational² maintainability are important to me?
- What realistic levels of operational maintainability are required?
- Have the required levels of operational maintainability been achieved?

From the seller's perspective, the issues are:

- How and when can the achievable levels of operational maintainability for a new product under development for the customer be assessed for realism (neither too optimistic nor too conservative given the nature of the development effort)?
- How can the customer's operational maintainability requirements be "translated" into design rules and requirements (i.e., design maintainability)?

¹ Acquisition Category 1A , Major Automated Information System Acquisition Programs.

²Section 2.1 of this handbook explains the differences between operational and design maintainability.

APPENDIX A

- What design approaches and analysis tools will help achieve the levels of maintainability required in the expected environment?
- How can progress toward meeting the required levels of design maintainability be measured?
- How and when can the achieved levels of design maintainability be demonstrated or determined?
- How can the design maintainability be retained during manufacturing?

In a purely commercial world, particularly when the customer is the average consumer, the customer is not usually concerned with the second set of issues - they are left to the seller to confront. If the seller does a poor job, the customer will go elsewhere for the product. Thus, competition in the marketplace provides a strong incentive to "do it right." In the defense world, the level of competition is often much lower than in the commercial world. If dictated by the nature of the product (e.g., used only by the military), the risks (e.g., very high with unproved technologies being used), and the type of acquisition (e.g., totally new development), it will be necessary for the Government customer to take more of an active role in addressing the second set of issues. (Some industrial customers also may be involved with the second set of issues, especially those dealing with measuring progress and determining the achieved level of design maintainability.) The form that this role takes, however, has changed.

Previously, by imposing standards and specifications, the military customer could force contractors to use certain analytical tools and methods, perform certain tests in a prescribed manner, use parts from an approved list, and so forth. As has already been discussed, the memorandum issued on 29 June 1994 by Secretary of Defense Perry primarily requires that military agencies develop and use performance-based specifications in solicitations. It permits the imposition of military standards and specifications as requirements only when performance specifications are inadequate and no commercial specifications and standards are suitable. Even then, military specifications and standards can be imposed only with a "blanket" waiver or the approval of the acquisition authority.

In any case, the objective under Defense Acquisition Reform is not to tell contractors how best to design and manufacture a product. The responsibility for making such decisions has shifted from the Government to the contractor. None-the-less, military customers are still more likely to be aware of the second set of issues than are commercial customers. Consequently, specifications issued by the Government will probably continue to be more detailed than those issued by commercial organizations. Of course, the procurement of commercial items or non-developmental items (NDI)³ provides the best opportunity to adopt a commercial approach to acquisition.

³Publication SD-2, Buying NDI, issued in April 1996 by the Office of the Assistant Secretary of Defense for Production and Logistics, defines commercial item and NDI.

APPENDIX A

b. The Solicitation. It is through the solicitation that a customer describes a needed product and solicits bids from competing sources to develop the product. Typically, a Government solicitation consists of the sections shown in Figure A-1.

PART I. THE SCHEDULE	
A.	Solicitation/Contract Form
B.	Supplies or Services and Prices/Costs
C.	Description/Specification/Work Statement
D.	Packaging and Marking
E.	Inspection and Acceptance
F.	Deliveries or Performance
G.	Contract Administration Data
H.	Special Contract Requirements
PART II. CONTRACT CLAUSES	
I.	Contract Clauses
PART III. LIST OF DOCUMENTS, EXHIBITS, AND OTHER ATTACHMENTS	
J.	List of Attachments
PART IV. REPRESENTATIONS AND INSTRUCTIONS (Solicitations and RFPs only)	
K.	Representations, Certifications, and Other Statements of Offerors
L.	Instructions, Conditions, and Notices to Offerors
M.	Evaluation Factors for Award
CONTRACT ATTACHMENTS (e.g., SOW or SOO)	
CONTRACT EXHIBITS (e.g., CDRL)	

FIGURE A-1. Sections of a Government Solicitation or Contract.

Of most interest to the maintainability engineer are the specification, Section L, and the statement of objectives (SOO) or statement of work (SOW). (Note: Military solicitations must be issued in accordance with the Federal Acquisition Regulations.)

(1) Section L provides instructions to the offerors and can be used to explain the information the offeror is expected to provide regarding how maintainability will be addressed in the program, should a contract be offered.

(2) As already discussed, the specification should be a performance specification, one that states requirements in terms of the required results with criteria for verifying compliance but does not state the methods for achieving the required results.

APPENDIX A

Traditionally, a military or commercial acquisition has only one specification. Some companies, however, have adopted a new approach to specifications. They issue an initial specification and then work with each prospective bidder to develop a specification unique to that bidder. In that way, multiple specifications are developed. The specifications reflect the technical capability of each bidder, and one bidder's specification may be more demanding than others, although all must meet the customer's needs. The bidder whose specification and price represents a best-value is awarded the contract.

In some cases, the customer does not provide a specification. For example, the general public does not provide automobile manufacturers with specifications for a vehicle. Instead, the automobile manufacturers must develop their own specifications based on such considerations as:

- federal, state, and other Government laws and regulations
- benchmarking of competitors' products
- market surveys and opinion polls

(3) The SOW normally includes constraints, assumptions, and other criteria that the bidders must consider in developing and manufacturing the product. For example, the customer should identify how the product will be used (operating concept) and supported (support concept). In a military procurement, such information could be included in Sections L and M of the solicitation. (See MIL-HDBK-245D for instructions on the preparation of a Statement of Work.)

The SOW may also include specific activities or tasks required by the customer. In the past, the SOW included with a military solicitation almost always identified specific tasks, such as "perform a Failure Modes and Effects Analysis." As stated earlier, the approach under Defense Acquisition Reform is to allow the bidders to identify planned activities and to explain why, how, and when these activities will be performed. Commercial customers seldom specify specific tasks but are, of course, free to do so.

Instead of the traditional SOW, some procuring agencies use a statement of objective (SOO). Considered more in keeping with the spirit of acquisition reform, the SOO is concise and written to allow the contractor as much flexibility as possible in responding to the solicitation. A typical SOO has five sections: Objective of the Program (Solicitation), Objective (Purpose) of the Contract, Scope of the Contract, Work to be Accomplished Under the Contract, and Program Control. The SOO is included as an attachment to a Request for Proposal (RFP), typically appended to Section L. Normally, the Government will ask offerors in response to the SOO to prepare and provide a SOW in their proposals. Specific efforts defined in an offerors SOW shall be traceable to the SOO. An example of how a SOO might be worded is shown in Figure A-2. Note that the SOO may not discuss specific disciplines. So it is especially incumbent upon the Government to ensure that maintainability is addressed in the specification.

APPENDIX A

In the section immediately following, guidance is given for preparing the maintainability portion of a solicitation. This guidance is consistent with the policies established by the Perry memorandum. In the final section of this appendix, guidance is provided for selecting a contractor on the basis of the maintainability portion of submitted proposals.

<p style="text-align: center;">Statement of Objectives</p> <p>1.0 Program Objective</p> <p>a. The program is: (here the customer defines the program as: (1) multi-phased, (2) single-phase, or (c) one program with multiple contractors)</p> <p>b. The objective of the program is to design, test, and manufacture [*] to satisfy the performance requirements of the specification to meet a need date of [date].</p> <p>2.0 Contract Objectives. The contractor shall meet the following objectives.</p> <p>2.1 Design, Analysis, and Test.</p> <p>Design the [*] to satisfy the user's performance requirements as defined in [cite applicable section of RFP]. Perform such analysis and tests necessary to design the [*], to reduce risk, and to verify that the product meets the user's performance requirements.</p> <p>2.2 Configuration Management</p> <p>Establish a product baseline to define the configuration of the [*] with a verified capability to satisfy the user's performance requirements. Establish and maintain a management process to thereafter control the product's configuration for the life of the contract. Document the design of the product baseline through the use of engineering data.</p> <p>2.3 Quality Control</p> <p>Institute a quality program to ensure the [*] is produced in accordance with engineering data, measuring and test equipment are properly maintained, and that appropriate actions are taken for nonconforming materials.</p> <p>2.4 Logistics</p> <p>Develop and deliver all data necessary to support the [*] (including provisioning, installation, and reprourement data and operating and repair manuals) consistent with the maintenance concept as stated in [cite applicable section of RFP]. All data shall be in a form and format compatible with existing Government data systems.</p> <p>*Name of the product</p>
--

FIGURE A-2. Example wording for a Statement of Objectives.

APPENDIX A

SECTION B. TEMPLATE FOR PREPARING MAINTAINABILITY SECTION OF SOLICITATION.

In developing the maintainability portion of a procurement package, two distinct areas must be covered. These areas are:

- performance-based requirements
- programmatic and reporting requirements

In the case of performance-based requirements, customers must specify maintainability either in terms they use to measure maintainability or in "translated" design terms. Commercial and military customers measure the performance of products in their own ways, to suit their own needs. A car owner may be most concerned with low cost of operation and quick and inexpensive repair. An airline may be most concerned with staying on schedule. These measures may or may not include factors within the control of the supplier. Furthermore, the way in which a customer measures the maintainability of a product in use may not be meaningful to a designer. If customer measures are placed in a specification, then the supplier must do the translation from the user's measures to measures more appropriate to design.

A two-step conversion might be needed to translate an operational need to a design parameter. Consider the following example in which we know what the operational availability⁴, defined by equation A-1, and the mean time between maintenance (MTBM) must be, and we want to specify both reliability and maintainability.

$$A_o = \frac{\text{MTBM}}{\text{MTBM} + \text{MDT}} \quad (\text{Equation A-1})$$

Solve for mean downtime (MDT) which includes the actual repair time plus logistics delay time. We've now "translated" A_o into MTBM and MDT. MTBM and MDT are operational measures that take into account factors that may be beyond the control of suppliers. So MTBM and MDT must now be translated into terms more suited to design (MTBF and MTTR, for example).

One way of translating operational terms like MTBM and MDT into specifications such as MTBF and MTTR can be done by examining the constituent elements of the operational terms. For example, MTBM normally includes all maintenance events. Suppose, through evaluation of field data or some other means, the number of maintenance events due to actual failures of fielded products (similar to the one to be developed) can be determined. This number can be divided by the total number of maintenance events giving a ratio we will call R. Then, a good estimate of MTBM (inherent), a good estimate of the specification MTBF, can be found by dividing the

⁴Operational availability, A_o , differs from inherent availability, A_i , because it accounts for all causes of maintenance (not just failures) and for all downtime (not just the time to repair).

APPENDIX A

customer's MTBM requirement for the product by the ratio R . Likewise, the ratio of the total mean downtime attributable to repair to total downtime, M , can be multiplied by the MDT to derive a first estimate of MTTR.

The process cannot end with the translation to a contractual value. The translated requirements must be evaluated for realism by the customer and by the supplier. The customer needs to check for realism to make sure that the cost of the product will not be driven up by unnecessarily high maintainability requirements. The supplier needs to check for realism to ensure that the product can be developed with the requisite level of maintainability. Questions that have to be answered are: are the requirements compatible with the available technology and do the requirements unnecessarily drive the design (conflict with product constraints such as weight and power). Answering these questions usually involves a review of previous studies and data for similar or comparative products. The requirements may need to be adjusted to account for improvement of technology, different operating environments, changes in force structure, different duty cycles, and so forth.

Requirements for maintainability that may be placed in a specification include but are not limited to:

- MTTR
- MDT
- Ambiguity group size
- Specific design requirements (see Appendix C of MIL-HDBK-470A)
- MTBM
- Maintenance hours per operating hour
- False alarm rate

In the case of programmatic and reporting requirements, the customer:

- may require the seller to prepare and submit reports describing the results of analyses, tests, and other activities conducted by the contractor and described in the maintainability program plan to design and manufacture a maintainable product
- for NDI and COTS, may require the seller to furnish operational data and the results of testing to substantiate maintainability claims
- may suggest standards and specifications to be used as guidance
- may require the seller to propose a method for verifying that maintainability requirements have been met

It should be the seller's responsibility to select the tasks and other activities that will achieve these objectives and to describe the tasks and activities in the maintainability program plan. When the customer mandates specific tasks (and, even worse, how to do the tasks), the contractor is, to some extent, relieved of the responsibility to ensure the tasks are value-added and are preferable to other tasks.

APPENDIX A

The following Template provides an outline for developing the maintainability portion of a procurement package. The following conventions are used.

Words within { } pertain only to new development efforts; words within [] pertain only to procurement of NDI or COTS. Procurement packages for programs involving both NDI/COTS and new development items should address each type of item separately but require that the maintainability efforts be integrated.

Blanks _____ indicate where the user of the template must provide a value or other information.

It licized words are optional instructions that may or may not be used depending on the desires of the user and needs of the procurement.

Notes to the reader are in parentheses with NOTE printed in all caps.

The reader is reminded that when purchasing NDI or COTS, the best course of action may be to require only data that substantiates any claims for performance and to emphasize the role of manufacturing processes (for NDI not yet in production) in determining the maintainability of the product. In some cases, even that data may not be needed if either the customer has already determined (through its own testing of samples, for example) that the product has the requisite performance or if use or independent testing of the product in actual applications has shown the product's performance to be satisfactory (for example, a personal computer in an office environment).

In any case, imposing tasks on manufacturers of NDI, if they were willing to bid on such a procurement, is counterproductive and expensive. The advantage of using NDI is that the development is complete (with possibly slight exceptions); the contractor already has done (or omitted) whatever might have been done to design a maintainable product. Again, what may be needed are data to substantiate claims of performance and certain activities intended to ensure that the integration of NDI into other products does not compromise the designed-in maintainability characteristics.

As previously discussed, in lieu of issuing a SOW with a specification, many customers now issue a SOO and require the offerors to include a SOW as part of their proposals. The best manner to respond to the solicitation would be left entirely to the bidders (for example, whether or not to have a maintainability plan). If the winning bidder did include such a plan in the proposal, it would then become contractually binding. Some buying offices now prohibit the solicitation from requiring the contractor to submit any plans.

A draft solicitation can be released by a customer for comment and suggestions for a statement of work by potential bidders. Based on the comments and suggestions received, a "negotiated" statement of work reflecting the bidders' best ideas on achieving the required level of maintainability would be included in the formal solicitation (assuming a SOO is not being used instead).

APPENDIX A

**TEMPLATE FOR DEVELOPING MAINTAINABILITY PORTION
OF A PROCUREMENT PACKAGE**

(NOTE: Not all possible requirements are listed, and not all listed requirements are necessarily applicable to all procurements.)

SECTION L

1. The bidder shall describe how he will meet the maintainability requirements of the solicitation. If a bidder elects to submit a maintainability program plan, the plan will become a part of the contract upon contract award. In any event, the bidders' responses will be evaluated using the following criteria.

1.1. The bidder shall describe all activities considered to {be necessary for ensuring the development of a} [have contributed to designing and manufacturing a] maintainable product. For each activity, the bidder shall describe the objective, rationale for selection, method of implementation, methods of assessing results, and any associated documentation.

1.2 The bidder shall explicitly address how the included activities {will be} [were] integrated into the product and manufacturing design processes.

1.3 The bidder shall show how the results of the included activities {will be} [were] used to support other activities, such as logistics planning, safety analyses, etc.

1.4 The bidder shall explicitly show a clear understanding of:

- a. the importance of designing in maintainability and the relationship of maintainability to other system performance characteristics.
- b. maintainability design techniques, methodologies, and concepts.
- c. the importance of integrating maintainability activities into the overall systems engineering process.
- d. the role of testability and diagnostics in maintainability and maintenance
- e. integrated diagnostics design principles

1.6 The bidder shall show how the following objectives {will be} [were] met:

- a. design for accessibility.
- b. design for human factors.
- c. minimize number of special tools (design so faults can be readily and confidently detected and isolated).
- d. design for testability.
- e. design for ease of inspection and incorporate provisions for non-destructive inspection.
- f. verification of requirements.
- g. evaluate the achieved maintainability.
- {h. determine feasibility of achieving required maintainability.}

APPENDIX A

THE STATEMENT OF WORK

(NOTE: Regarding the next section, the reader is reminded that mandating tasks, even for new development, is somewhat risky because it relieves the bidders of the responsibility for selecting the best means to accomplish the desired ends [in this case, meet the maintainability performance requirements]. Mandating tasks should be done only after careful consideration of the advantages and disadvantages of doing so. **Even then, bidders should not be told how to accomplish the required task.**)

{1. The following activities will be conducted by the bidder and reflected in the technical approach.

1.1 Develop a maintainability model and make initial maintainability predictions using that model. All predictions shall be made at a stated level of confidence.

1.2 Conduct an Integrated Diagnostics Analysis to identify the best mix of automatic, semi-automatic, built-in, and manual test capabilities; identify expected false alarm, cannot duplicate, and retest OK rates; and identify levels of isolation and ambiguity.

1.3 Use computer modeling or other techniques to determine the accessibility of components for servicing and maintenance.

1.4 Conduct an analysis, such as a Fault Tree Analysis or FMEA to assist in the efficient design of BIT and external test equipment and to assist in the identification of corrective maintenance requirements. Rationale for selecting the chosen analysis technique will be given.

1.5 Conduct Human Factors analyses to ensure that any human-machine interface is acceptable.

1.6 Conduct a maintainability demonstration. The contractor shall explain how the demonstration will be implemented and the underlying statistical basis of the demonstration.

1.7 Conduct a safety analysis to identify risks to support personnel.

1.8 Conduct a _____ (NOTE: others as determined by buyer) _____ }

APPENDIX A

(NOTE: All reports, data requirements, and deliverable documents should be identified in the Contract Deliverables Requirements List (CDRL). Data items can include FMEA results, results of trade studies, BIT analyses results, and so forth. Data items should be selected based on the nature of the development, the level of risk, intended use of the item [benefit], and cost. The CDRL should provide data format and content preparation instructions and data delivery requirements. Although the text of the SOW should not include these items, a data item description number listed in the CDRL may be cross-referenced in the SOW. This cross reference should usually be made in the paragraph describing the task that will lead to the development of the data or document.)

APPENDIX A

THE SPECIFICATION

1. The following levels of maintainability are required. Note: All values are the minimum acceptable values at a ____ confidence level, when appropriate.

(NOTE: Not all possible quantitative requirements are listed, and not all listed requirements are necessarily applicable to all procurements.)

1.1 Platform-level (e.g., end product):

1.1.1 ____ mean time to repair

1.1.2 ____ maximum active corrective maintenance time at the ____ percentile on a log-normal distribution

1.1.3 ____ mean corrective maintenance time

1.1.4 ____ mean preventive maintenance time

1.1.5 ____ mean time to fault isolate

1.1.6 ____% maximum False Alarm Rate for BIT

1.1.7 ____ % to ____ LRUs Fault Isolation Capability

1.1.8 100% fault detection through integrated diagnostics

1.1.9 ____ : average maintenance personnel skill level (customer-defined title or designation)

1.2 Critical Systems (NOTE: User must define these)

1.2.1 ____ mean time to repair

1.2.2 ____ maximum active corrective maintenance time at the ____ percentile on a log-normal distribution

1.2.3 ____ mean corrective maintenance time

1.2.4 ____ mean preventive maintenance time

1.2.5 ____ mean time to fault isolate

1.2.6 ____% maximum False Alarm Rate for BIT

1.2.7 ____ % to ____ components or modules within LRUs Fault Isolation Capability

1.2.8 100% fault detection through integrated diagnostics

APPENDIX A

2. The design of the product and all components shall be such that:

- functionally different items cannot be interchanged
- a fastener cannot be installed where a longer fastener is required
- equipment can be operated and maintained by personnel whose anthropometric dimensions are within the ____ percentile values for _____. (NOTE: user must stipulate the percentile and whether it is for men, women, or both. Also, a reference from a military or other Government or commercial standard giving the anthropometric measurements should be cited.)
- equipment can be operated and maintained by personnel wearing clothing appropriate for the range of climatic conditions described in Section _____.
- the probability of a catastrophic hazard to personnel during normal operation and maintenance is essentially zero.
- personnel do not have to lift or carry weights that exceed those prescribed for the ____ percentile _____. (NOTE: user must stipulate the percentile and whether it is for men, women, or both. Also, a reference from a military or other Government or commercial standard giving the maximum prescribed weights should be cited.)

3. The product will be designed so that its maintainability will not be reduced due to the effects of being shipped by land, sea, or air or by periods of storage up to _____ life units. (NOTE: User must state the proper life units, either months or years.)

4. All maintainability requirements apply to the product as it will be used in the operating and support environment defined in Section _____ of the Specification and in accordance with the operating and support concepts defined in Section _____ of the _____.

APPENDIX A

SECTION C. GUIDANCE FOR SELECTING SOURCES

The maintainability portion of a bidder's proposal can be evaluated using the criteria in Figure A-3. In addition to the criteria listed in the figure, the customer should encourage and look for innovative approaches that achieve the maintainability performance requirements in the most effective way. Also, the proposal should emphasize the following objectives:

- Understand the Customer's Maintainability Needs - if the customer has not explicitly done so, determine the required level of maintainability as measured by the user during actual use of the product. No matter the source of the requirement, determine the feasibility of achieving the required maintainability and track progress toward that achievement.
- Thoroughly Understand the Design - understand the maintainability of the design and the maintenance required for the product.
- Integrate Maintainability with the Systems Engineering Process - make the maintainability activities conducted during design and manufacturing an integral part of the product and processes design effort. Ensure all sources (i.e., suppliers, vendors, etc.) of components, materials, etc. used in the product, design and manufacture those components and materials in accordance with the maintainability requirements.
- Design for Desired Level of Maintainability - use proven design approaches to make needed maintenance safe, economical, and easy to perform.
- Validate the Maintainability Through Analysis and Development Test - conduct analyses, simulation, and testing to uncover maintainability problems, revise the design, and validate the effectiveness of the redesign.
- Monitor and Analyze Operational Performance - assess the operational maintainability of the product in actual use to uncover problems, identify needed improvements, and provide "Lessons Learned" for incorporation in handbooks and for refining modeling and analysis methods.

NOTE: The following list is not all-inclusive and not all items necessarily apply to every program

Understanding. Does the proposal show a clear understanding of:

- the importance of designing in maintainability?
- maintainability techniques, methodology, and concepts?
- the role of testability and diagnostics in maintainability and maintenance?
- integrated diagnostics design principles?
- the importance of integrating maintainability activities into the overall systems engineering process?

FIGURE A-3. Checklist for Evaluating Maintainability Portion of a Proposal.

APPENDIX A

Approach

- **Management.** Does the proposal identify:
 - who is responsible for maintainability and his/her experience and qualifications?
 - the number and experience of maintainability personnel assigned to the program and the level of effort allocated to maintainability activities?
 - how maintainability personnel fit in the program's organizational framework?
 - an effective means of communication and sharing of information among maintainability engineers and analysts, design engineers, manufacturing engineers, and higher management?
 - how the testability and diagnostics functions are integrated into the maintainability function?
 - the suppliers' system for controlling the maintainability of items from other suppliers & vendors?
 - how the supplier implements concurrent engineering practices and integrates maintainability into the overall engineering and manufacturing effort?
- **Design.** Does the proposal explain:
 - if and how design standards, guidelines, and criteria will be used?
 - the approach to designing for testability and diagnostics?
 - if and how tradeoff studies will be used for critical design areas?
 - the time-phasing of maintainability activities in relation to key program milestones?
 - any areas of maintainability risk?
 - if and how software maintainability will be addressed?
- **Analysis/Test.** Does the proposal identify and describe:
 - methods of analysis and math models to be used?
 - maintainability modeling, prediction, and allocation procedures?
 - the time phasing of any proposed maintainability testing in relation to the overall program schedule?
 - the time available for the test type required (such as maximum time for maintainability demonstration) and how that time was determined?
 - if and how the supplier will predict the maintainability (in whatever parameters are specified) prior to the start of testing?
 - the resources (test chambers, special equipment, etc.) needed to perform all required testing, how they were determined, and their availability?
 - how the results of all testing will be used to evaluate maintainability and identify maintainability problems?

Compliance

- **Design.** The proposal should include:
 - evidence of compliance with military and commercial specifications and standards, when required, and good engineering practices for maintainability.
 - evidence that ease of maintenance and preventive maintenance requirements will be addressed.
 - justification (models, preliminary estimates, data sources, etc.) to back up the claims of meeting maintainability requirements.
- **Analysis/Test.** The proposal should indicate:
 - an explicit commitment to perform all maintainability analyses cited in the proposal or required by contract.
 - an explicit commitment to perform all maintainability testing cited in the proposal or required by contract.
 - that the supplier complies with all product-level maintainability test requirements and that the contractor will demonstrate the maintainability figures of merit by test using any specified accept/reject criteria or by analysis.
 - if and how the contractor will perform verification or demonstration testing, the type of testing planned, and the specific purpose of the testing.
- **Data.** The proposal should show an explicit commitment to deliver all required maintainability data items in the format specified.

**FIGURE A-3. Checklist for Evaluating Maintainability Portion of a Proposal.
(continued)**

APPENDIX B

MAINTAINABILITY TEST AND DEMONSTRATION METHODS

B.1.0 Scope

This Appendix is an essential part of MIL-HDBK-470A. The information contained herein is intended for reference only. Much of this appendix is based on the information that was contained in MIL-HDBK-471 (formerly MIL-STD-471A), *Maintainability Verification/Demonstration/Evaluation*. Although the referenced document covered verification, demonstration and evaluation, the methods presented dealt primarily with maintainability demonstration. Part of the reason is that separate tests designed and planned specifically to verify or evaluate the maintainability characteristics of a design have not typically been part of a system development program. In the case of reliability, testing such as reliability growth testing is a separate process from reliability qualification testing or production reliability acceptance testing. No such techniques, in the form of handbooks or standards have been developed for similar (e.g., maintainability growth) testing associated with maintainability. Consequently, in this Appendix, specific techniques for maintainability demonstration testing will be presented, while other types of maintainability testing (i.e., verification and evaluation) will be addressed from a more qualitative aspect.

This Appendix is for guidance only and cannot be cited as a requirement. If it is, the contractor does not have to comply.

B.1.1 Purpose. The purpose of conducting maintainability tests is to verify, demonstrate and evaluate both quantitative and qualitative maintainability characteristics of a design. Quantitative parameters include metrics discussed elsewhere in this handbook, such as MTTR, M_{ct} , or $M_{Max_{ct}}$.

B.1.2 Definitions. The following terms, used and discussed within this appendix are as defined as follows:

B.1.2.1 Maintenance Task. The maintenance effort necessary for retaining an item in, changing to, or restoring it to a specified condition.

B.1.2.2 Maintainability Model. A quantifiable representation of a test or process the purpose of which is to analyze results to determine specific relationships of a set of quantifiable maintainability parameters.

B.1.2.3 Verification. The effort performed from system concept through the hardware development phase to: determine the accuracy of and update the analytical (predicted) data obtained from the maintainability engineering analysis, identify maintainability design deficiencies, and gain progressive assurance that the maintainability of the system or item can be achieved and demonstrated in subsequent phases.

APPENDIX B

The effort to verify maintainability parameters that are developed during Phase 0 (e.g., predicted values of MTTR), is incremental in nature commencing with initial design and continuing through hardware development from components to the configuration item. The basic objectives of maintainability verification are:

- To verify and update the contractor's maintainability model.
- To ensure economical correction of design deficiencies and to provide assurance that maintainability requirements will be achieved and demonstrated, if required, by performing early in the design process, maintainability verifications such as limited low confidence maintainability tests, time-motion measurements or such other tests as may be proposed by the system developer.
- To provide progressive assurance that the maintainability requirements can be achieved and demonstrated and that elements of the integrated support plan directly related to maintainability are valid.

Maximum use should be made of data resulting from maintenance performed in conjunction with such tests as development, prototype, mock-up, qualification, and reliability tests. In this respect, collection of maintenance task data must be planned for and coordinated with other disciplines. (See Section 4.5 of this handbook for a discussion of maintainability data elements to be collected as part of a Failure Reporting, Analysis and Corrective Action System [FRACAS]). Further, specific maintenance tasks used in development of the maintainability model and prediction must be clearly defined such that when failures occur during development testing that result in a specific maintenance task, the maintenance time can be compared to that used in the prediction model. This must be done for both preventive (as applicable) as well as corrective maintenance tasking.

B.2.1 The Importance of Verification Testing. Development of a predicted value for maintainability, whether it be a mean corrective maintenance time, mean downtime, or other parameter, is based on time estimates of individual tasks associated with maintenance of a system and its individual parts. The reliability data, such as failure frequency and failure mode and effects, play a role in maintainability prediction as well, since it is the failure modes, their effects and frequency of occurrence that ultimately define individual maintenance tasks to be performed. In order to develop a maintainability prediction, the predictor must assume that a person with a particular skill level will be assigned to maintain a particular subsystem within the system of interest. Further, estimates of fault isolation time and fault detection capability must also be developed based on the testability design and assumed effectiveness of any built-in-test (BIT) features incorporated at various system levels. Often, time estimates derived in this manner are based on experience and knowledge of the individual performing the estimate. Therefore, the chances for bias in a prediction exist, especially if such factors as maintenance environment are not well understood early in the design phase. It is important then to verify the maintenance task database that is used to obtain the predicted values as a means of improving the maintainability

APPENDIX B

design aspects of the system, and to improve the chances of performing a meaningful and successful maintainability demonstration.

In addition to the preceding discussion, testability aspects, such as BIT effectiveness, are not easily verified in a formal demonstration test. This is due in part to the fact that such failure mechanisms that cause transient or intermittent behavior are not easily simulated in a laboratory environment (where many demonstrations take place). Further, the number of failures induced in a demonstration represent such a small part of the overall number of failures that may occur during fielded operation and are therefore too small to really demonstrate the diagnostic capabilities of a system design. Because of this, a well planned verification program, that optimizes naturally occurring failures during development and subsequent testing is needed to assess the diagnostic characteristics of the design. In short, demonstration techniques and methods that are documented in this appendix (and previously in MIL-HDBK-471A) are inadequate for testability demonstration. Further discussion of testability verification is provided in Section B.7 of this appendix.

B.2.2 Verification Techniques and Concepts. The means by which verification is accomplished will depend on the maintainability characteristic or data element to be verified. For qualitative elements, such as accessibility, clearances for use of tools, available work space, or safety concerns, ease of maintenance studies can be planned and executed. This may include the use of mock-ups, or in the future, the use of virtual mock-ups using virtual reality techniques as discussed in Section 4 of this handbook. Other verification methods include design reviews, other special studies (e.g., maintenance task analysis or simulation studies), or review of historical information on like systems. The verification process should be continuous throughout the system life cycle, and therefore data obtained from maintainability demonstration testing (see Section 3 of this appendix) and operational test and evaluation should also be used to verify both quantitative and qualitative features.

The process of executing a verification program should follow the general procedural elements outlined below:

- Identify possible data sources and develop data collection and analysis plan
- Evaluate both qualitative and quantitative data
- Compare results with requirements

Quantitative data analysis typically relates to collecting information on maintenance task times, such as removal and replacement times, and developing an approach to statistically compare actual data to predicted values.¹

¹ See Downs, W.R., "System Maintainability Verification - The Paired Time Comparison (PTC) Method," Proceedings, 1979 Annual Reliability and Maintainability Symposium for an example of a method used for verification.

APPENDIX B

B.3.0 Maintainability Demonstration

As discussed here, the purpose of conducting a maintainability demonstration is to provide assurance that a specified maintainability index (i.e., MTTR, MDT, MMH/OH, etc.) will be attained during fielded operation. This is done by scheduling and execution of a demonstration test wherein maintenance tasks are performed at a specified level of maintenance (e.g., organizational, intermediate, depot) by personnel having the skill levels available or required in the fielded maintenance environment. For each maintenance task performed, where a typical task is to isolate and repair a failed unit, the time required to perform the maintenance task is recorded. Depending on the maintainability index being demonstrated, and the test plan chosen, once a statistically significant number of tasks are performed, the collected data are then used to determine if the maintainability is acceptable or not. In addition to the quantitative data collected during the demonstration test, qualitative information, such as the adequacy of test support documentation or ease of maintenance (accessibility, safety, etc.) is also collected and reviewed.

B.3.1 Maintainability Demonstration Test Specification. As noted, the purpose of the demonstration test is to provide assurance of the ability to meet a specified maintainability requirement. The demonstration test is defined as a set of numerical requirements and associated risk levels that will govern the design and decision criteria of the demonstration test. For the test plans to be described, this specification involves decisions regarding the following:

- Type of maintainability index to be specified
- Acceptable and unacceptable values of the index
- Associated risk levels

For example, the test specification might be as follows:

H_0 : Mean corrective-maintenance time = 40 minutes

H_1 : Mean corrective-maintenance time = 80 minutes

$\alpha = 0.20$, $\beta = 0.10$

H_0 and H_1 are the null and alternative hypothesis, respectively. α and β are the producer and consumer risks, respectively. For the defined specifications above, the demonstration test must be designed such that the probability of rejecting a system whose mean corrective maintenance time is 40 minutes is 0.20, while the probability of accepting a system whose mean corrective maintenance time is 80 minutes is 0.10. This is presented below in the form of probability equations.

$P(\text{reject} \mid M_{ct} = 40 \text{ min.}) = 0.20$

$P(\text{accept} \mid M_{ct} = 80 \text{ min.}) = 0.10$

APPENDIX B

Typically the maintainability index is that specified in the procurement specification. The index should represent a measure that is directly influenced by the equipment design so that the producer can plan for high assurance of a pass decision, but bears the responsibility for a reject decision. The index should also be appropriate for, and measurable in, the demonstration-test environment. If a demonstration of the chosen maintainability index is to be required, then adequate sampling and statistical-evaluation procedures, such as those described in this appendix, should be available for demonstrating conformance to the requirement. Finally, the specified index and risk values should not lead to sample sizes (i.e., the number of maintenance tasks required to assess compliance) that would exceed available test resources.

B.3.2 Choosing a Demonstration Test Method. Table B-I provides a summary of the test methods presented in this appendix. For each test method, the table also lists the maintainability index for which the plan is designed to demonstrate, a summary of assumptions, the required number of samples, the method by which samples are selected, and the demonstration specification parameters. Definitions of individual terms found in the "Specification Requirement" column of B-1 can be found in the subsection where the method is presented.

In reviewing Table B-I, it is evident that a number of factors influence the choice of a maintainability demonstration test method. These include the index to be demonstrated, any assumptions about the statistical nature of the index as related to the test method requirements, the means by which sample maintenance tasks are selected, the number of maintenance tasks that must be demonstrated to obtain a statistically significant number of data samples, and the individual producer's and consumer's risk for some of the tests. Guidance and discussions of some of these factors are provided in the sections that follow, to aid the user in making informed decisions when specifying and executing a maintainability demonstration.

B.3.3 Choosing a Maintainability Index. As stated above, historically the specified maintainability index is also the one that is demonstrated. However, it is important to provide some guidance on choosing such an index, as this can affect which of the test methods, outlined in Table B-I, is chosen for Maintainability Demonstration testing.

The principal criterion in selecting the index for a maintainability demonstration (and therefore for a product specification) is consistency with the mission objectives and operational constraints. This will generally mean that equipment downtime is the time measurement of the index since operational effectiveness cannot be achieved unless downtime is controlled. If the need for an equipment or system is not critical, and manpower control is important, a labor-hour index may be most appropriate. Preventive-maintenance labor-hours per operating hour is preferable to downtime due to preventive maintenance for equipments for which such required maintenance can be scheduled without fear of operational demand during the maintenance action.

APPENDIX B

TABLE B-I. Test Method Matrix.

Test Plan	Test Index	Assumptions	Sample Size	Sample Selection	Specification Requirement
1-A	Mean	Log-normal dist. and prior knowledge of variance	See test method	Natural occurring failures or stratification ¹	H_0, H_1, α, β
1-B	Mean	No dist. assumption, prior knowledge of variance	See test method	Natural occurring failures or stratification	H_0, H_1, α, β
2	Critical Percentile	Lognormal dist., prior knowledge of variance	See test method	Natural occurring failures or stratification	H_0, H_1, α, β
3	Critical Main. Time or Manhours	None	See test method	Natural occurring failures or stratification	H_0, H_1, α, β
4	Median	A Specific Variance Log-normal	20	Natural occurring failures or stratification	ERT
5 ²	Chargeable maint. Downtime/ Flight	None	See test method	Natural occurring failures	ORR or A, NCMDT/NOF DDT/NOF, α, β
6 ³	Manhour Rate	None	See test method	Natural occurring failures	Manhour Rate Δ MR
7 ⁴	Manhour Rate	None	See test method	Natural occurring failures or stratification	μ_R, α
8	Mean and Percentile	Log-normal	See test method	Natural occurring failures or Simple random sampling	Mean, M_{Max}
	Dual Percentile	None			Dual Percentile
9	Mean (Corrective Task Time, Prev. Maint. Time, Downtime)	None	30 minimum	Natural occurring failures or stratification	$\mu_c, \mu_{pm}, \mu_{p/c},$
	M_{Max} (90 or 95 percentile)				M_{Max_c}
10	Median (Corrective task time, Prev. maint. time), $M_{Max_{ct}}$ (95 percentile), $M_{Max_{pm}}$ (95 percentile)	None	50 minimum	Natural occurring failures or stratification	$\tilde{M}_{ct}, \tilde{M}_{pm}$ $M_{Max_{ct}}, M_{Max_{pm}}$
11	Mean (preventive maint. task time) M_{Max} (preventive maint. task time at any percentile)	None	All possible tasks	All	μ_{pm} $M_{Max_{pm}}$

- Notes for Table B-I:
- (1) See section 3.3 for stratification method for sample selection
 - (2) Test method 5 is an indirect method for demonstrating operational ready rate (ORR) or Availability (A).
 - (3) Test method 6 is intended for use with aeronautical systems and subsystems.
 - (4) Test method 7 is intended for use with ground electronic systems where it may be necessary to simulate faults.

By the same reasoning, corrective maintenance is more crucial than preventive maintenance, especially if the latter can be scheduled to take place during known periods of non-use. For equipment operated or needed continuously, such as an alert radar, total maintenance time is of

APPENDIX B

prime importance. For equipment demanded at random times, such as a missile-defense system, the approach might be to use separate controls for corrective maintenance and preventive maintenance. The choice of the statistical measure to be used often depends on the mission objective. If there is an operational availability requirement for the system, then the equation for A_o , reprinted below from Section 2.2.1.2 of the handbook, is used to determine maintainability requirements.

$$\text{Operational Availability} = \frac{\text{MTBM}}{\text{MTBM} + \text{MDT}} \quad (\text{Equation B-1})$$

Inherent availability may also be a requirement, in which case MTBF and MTTR are substituted for MTBM and MDT, respectively, in the above equation. When either availability expression is appropriate, then a mean value becomes the maintainability index to be demonstrated. There may be, however, an availability requirement where a maximum downtime or mean time to repair is required or more appropriate. Such a requirement would apply to critical equipment aboard an aircraft, for example, where the aircraft may have to be available for a new mission within two hours after completing a mission. In this case, a requirement of 0.95 probability, for instance, of completing the necessary maintenance within 100 minutes would be more consistent with the operational objective than a mean-value index. Of course, the maintenance level for which the requirement is developed also plays a role. For instance, a maximum time to repair may not be appropriate or needed at the intermediate or depot-level of maintenance assuming that an adequate amount of spares are available at the next lower level of maintenance (i.e., organizational or intermediate, respectively).

To provide further guidance in choosing an appropriate index for demonstration, a guidance matrix is provided in here in Figure B-2.² To use the matrix, each of the conditions listed at the top of the exhibit that apply to the equipment of interest should be checked. The appropriate index is then found from the matrix by locating the column that contains an x for each condition checked above. For example, if steady-state availability is a critical parameter (Condition 1) and maintenance time is limited by environmental or operational circumstances (Condition 5), the recommended index provides a control on both the mean and maximum maintenance time, and there is an option for including preventive-maintenance time depending on equipment use or scheduling and criticality. The set of conditions listed is not exhaustive, but it is believed to include the most important ones.

² Taken from RADC-TR-69-356, "Maintainability Prediction and Demonstration Techniques, Volume II -Maintainability Demonstration," Technical Report, ARINC Research Corporation, January 1970.

APPENDIX B

<u>Condition Identification</u> (Place an x in appropriate boxes)																			
<u>Condition</u>																			
<input type="checkbox"/>	1	Steady-state availability is a critical parameter.																	
<input type="checkbox"/>	2	Steady-state availability is not a critical parameter.																	
<input type="checkbox"/>	3	Maintenance-time distribution is unknown.																	
<input type="checkbox"/>	4	Maintenance-time distribution is expected to be lognormal.																	
<input type="checkbox"/>	5	Environmental or operational circumstances limit maintenance time.																	
<input type="checkbox"/>	6	Manpower allocation or cost is an important factor.																	
Selection Matrix ¹																			
Index Condition	\bar{M}_{ct} and \bar{M}_{pt} ²				\tilde{M}_{ct}			M_{max}			MMH			\bar{M}_{ct} and M_{maxct} ² \bar{M}_{pt} and M_{maxpt}				\tilde{M}_{ct} and M_{maxct} \tilde{M}_{pt} and M_{maxpt}	
	x	x	x	x	x	x	x	x	x	x	x	x	x	x	x	x	x		
1	x	x	x	x										x	x	x	x		
2					x	x	x	x	x	x	x	x	x				x		x
3		x				x			x			x			x				x
4		x	x				x			x			x			x	x		
5								x	x	x				x	x	x	x		x
6				x							x	x	x				x		x

Notation \bar{M} = mean, \tilde{M} = median, M_{max} = maximum maintenance time, MMH = maintenance man-hours
 ct = corrective maintenance, pt = preventive maintenance

Notes 1 The inclusion of preventive-maintenance indices is optional depending on scheduling and criticality.
 2 A combined total-maintenance-time index can be used instead of separate indices for corrective and preventive maintenance.

FIGURE B-2. Procedure For Maintainability-Index Selection.

Several of the major considerations that led to the development of the matrix are as follows:

- The mean is directly related to steady-state availability and is therefore the index of choice when this operational requirement exists.
- If the distribution of maintenance times is unknown, the median is preferred since it permits distribution-free tests. If availability is critical, however, use of the central-limit theorem permits a mean test, provided the sample size is large.

APPENDIX B

- For the lognormal distribution, the median is preferred to the mean (assuming that Condition 2 applies and that 5 and 6 do not) since it is based on only one parameter, which makes statistical analysis exact.
- When maintenance time is limited (Condition 5), the M_{Max} index is preferred.
- The mean is preferred over the median if manpower control is also required because the mean is more directly related to manhours. However, if the distribution is unknown, the median may be used as long as availability is not critical.

Note that complete dependence on this procedure is to be avoided. Because of the wide variety of equipments, mission objectives, and environmental and operational circumstances, the selection matrix should be considered a guide only. Ultimately, the best measure is determined by individual system circumstances and good judgment.

Finally, no matter what indices are specified in the requirements or as the index to be demonstrated, the values for those indices must be realistic, based on current knowledge of the state-of-the-art, past history of like systems, and engineering judgment. Whether historical data or prediction, or both, is used for assessing realism, careful judgment is required. If an allocation leads to an M_{ct} value of 20 minutes, but a 30 minute value was observed for the most similar existing item, can it be concluded that 20 minutes is achievable? In all such cases, the following questions should be considered:

- How similar are the items?
- How similar will the maintenance environment be?
- Since the observed 30-minute value is necessarily based on a sample, what is the lower confidence limit associated with such a mean-value estimate?
- How much maintainability improvement can reasonably be expected?
- Is there any margin for increasing the 20-minute specified value?

B.3.4 Demonstration Environment Versus Requirements. Past history has shown that demonstrated and predicted values of both reliability and maintainability often do not correlate well with actual field experience. In the case of demonstrated maintainability values, this most likely stems from the fact that the demonstration environment is often not the fielded environment. Studies have shown that the closer the demonstration test environment is to the expected field environment, the more meaningful the demonstration test, and therefore every effort should be made to achieve such similarity.

In most cases, it is likely that demonstration environments will continue to differ from the field environment. Because of this, when maintainability demonstration environments are based on operational requirements, the applicability of that requirement to the demonstration environment needs to be considered. As a general principle, the specified value based on operational goals and conditions must be suitably adjusted to reflect the maintenance environment governing

APPENDIX B

demonstration. Often, it is a difficult to adhere to this principle. With an avionics system, for example, a certain amount of time will be spent in the field to access the equipment in the aircraft, and the time to locate the malfunction and complete repairs and checkout is a function of this accessibility. If the demonstration test is not to take place in the aircraft (and this is often the case) there is the question of whether the specified value should be adjusted and by how much.

It might be possible to construct a mockup to simulate the actual condition, thus eliminating the need for adjustment. However, this type of simulation is often expensive and therefore not practicable. Tables B-II and B-III list various factors to be considered in evaluating the applicability of a specified maintainability index.

TABLE B-II. Factors Affecting the Suitability of a Specified Maintainability Index for Maintainability Demonstration.

Physical Equipment	Support Items
Stage of completion	Tools
Similarity to production items	General and special test equipment
Physical location	Spares availability
Interfacing equipment	Technical manuals
Test Location and Facility	Operational Factors
Lighting factors	Mode of equipment operation
Weather factors	Procedures for instituting maintenance
Space factors	
Test Team	
Organization	
Training and experience	
Indoctrination	

TABLE B-III. Causes of Discrepancies Between Test and Field Results.

<p>Causes of Optimistic Test Results</p> <ol style="list-style-type: none"> 1. The demonstration maintenance technicians are not representative of typical field maintenance personnel because they have more education and training or greater knowledge of the equipment's design. 2. The monitoring situation imparts to the technician an urgency not normally encountered in the field. 3. Known probable tasks are rehearsed beforehand. 4. Necessary support equipment is readily available. 5. Observed times are not contaminated with such factors as administrative or logistic delay, as field results sometimes are. 6. Difficult to isolate faults such as intermittents and degradation failures are not simulated during demonstration.
<p>Causes of Pessimistic Test Results</p> <ol style="list-style-type: none"> 1. The technicians are not familiar with the equipment and have not acquired the necessary experience for rapid fault isolation. 2. Field and procedural modifications to reduce maintenance time have not yet been made. 3. Initial manuals may be incomplete or require revision. 4. The monitoring situation can adversely affect the technician's performance.

APPENDIX B

B.3.5 Maintenance Task Sampling. It is necessary to choose a specified number of maintenance tasks for the demonstration test. In general, there are two basic approaches for sample selection:

1. Observe maintenance tasks as they occur naturally in an operational or simulated operational situation.
2. Induce faults in the system and observe the maintenance actions to correct these faults.

For the fault-inducement approach, a decision must be made on the type of sampling procedure to be used. This is generally between stratified sampling and simple random sampling. Guidelines are presented here for evaluation of the applicability of the two basic approaches, obtaining maintenance-task samples, and choosing the appropriate sampling design and procedure.

B.3.5.1 Natural Versus Induced Failures. It is important that the choice of sample selection be made early in the development program, especially if the choice is naturally occurring failures or a combination of the two. The natural-failure approach is dependent on whether the program schedule allows enough time to obtain the required number of maintenance tasks, where the allowable time is related to reliability. Given the MTBF, or θ , of a system, the average number of operating hours needed to yield n failure occurrences is $n\theta$. Therefore, for items with large MTBFs (i.e., hundreds of hours), and a required sample size of say 30 to 50 tasks, the number of required equipment operating hours can easily exceed 10,000 (e.g., 50 samples from an item with an MTBF of 200 hours). Because of the time requirements of this magnitude, most maintainability demonstrations are based on the fault-inducement approach, allowing demonstration to be completed in a few days.

While the reality of cost and schedules dictate the use of induced failures for maintainability demonstration, the natural failure approach is the preferred one. A disadvantage that has always existed with inducing failures is that there is no guarantee that such faults are representative of those which will be seen in operation. This disadvantage is amplified when considering demonstration of diagnostic features of a design. Because of these problems, the following general recommendations are made concerning sample selection:

- If the schedule allows for natural failures, then this type of sampling is preferred.
- If the complete demonstration cannot be completed with only naturally occurring failures, a combination of the two approaches should be used. One possibility is to take advantage of other development tests, such as the reliability demonstration test and correct faults that occurred in these tests. Close coordination between the maintainability demonstration test and any other test will be required.
- If natural failure testing cannot be conducted, any natural failures that do occur during the induced failure test should be included in the sample.

APPENDIX B

B.3.5.2 Failure Inducement Approach. An initial step in developing a sample set of tasks for demonstration is to develop a hypothetical maintenance task population. The two basic approaches to identifying the maintenance task groups are simple random sampling and stratification. For discussion purposes, comments will be restricted to stratification, as they will also generally apply to simple random sampling when task selection by failure inducement is being considered.

The first task in stratification is choosing criteria by which to stratify. This involves the characteristic by which to stratify, the number of strata, and the boundaries defining the individual strata. The major objective here is to divide the equipment for which maintainability is to be demonstrated into a subset of homogeneous groups. To accomplish this, the maintenance tasks within each group, or stratum, should require approximately the same amount of maintenance time or the same number of manhours, whichever is most appropriate. Blind application of this requirement, however, is not recommended. Repairing an electronic assembly within a system may take approximately the same amount of time as repairing a motor within the same system; however the differences between the two types of maintenance actions would make it unnatural to place them in the same stratum. Therefore, it is reasonable to make sure that there are similarities among the tasks assigned to a stratum. As is evident, engineering judgment must always play a role when grouping elements of this nature. The following approach is presented as additional guidance to stratum development.

- First divide the equipment or item by physical entities, such as equipments within a system or units within an equipment. These first level breakdowns will be called blocks.
- For each block, subdivide to the highest system level at which maintenance will be performed. If the block is the highest level, no further subdivision is necessary. If an equipment is under test and the organizational maintenance philosophy is unit replacement, subdivide to the units. These elements of the subdivision will be called sub-blocks.
- For each sub-block, list the associated maintenance tasks and estimated maintenance task times or manhours. For a sub-block that is a Line Replaceable Unit (LRU), or equivalent, removal or replacement may be the only task listed. However, if LRU adjustment or some further tasks such as crystal replacement are possible, they would also be listed as sub-block tasks.
- Group together those tasks in each sub-block which require essentially similar actions and will be expected to have similar maintenance times or manhours, whichever index applies. The use of historical and predicted data, and previous development tests should be used as inputs for the time estimates. These groups will then form part of the initial set of strata.

The initial set of strata may have to be revised when the actual tasks to be induced and sample-size requirements are considered. An example of the preceding four-step process is provided

APPENDIX B

TABLE B-V. Calculations of Relative Frequency of Occurrence and Sample Size For Example Radar Equipment.

Maintenance Task Strata	Failure Rate (λ) $\times 10^{-6}$	Quantity of Items	Duty Cycle	Tot λ	Relative Freq of Occurrence	Cum. Range	Sample Size*
Antenna R/R	105	1	1.0	105	0.175	0 - .1749	9
IF -R/R	25	2	1.0	50	0.083	.1750 - .2579	4
Amp - R/R	21	1	1.0	62	0.104	.2580 - .3619	5
Mod - R/R	18	1					
PS - R/R	23	1					
Tx - R/R	10	1	1.0	10	0.017	.3620 - .3789	1
FT	400	1	0.7	280	0.467	.3790 - .8459	23
FT - Replace Crystal	20	4	0.7	56	0.093	.8460 - .9389	5
C - R/R	35	1	0.8	28	0.047	.9390 - .9859	2
ID R/R	10	1	0.8	8	0.013	.9860 - 1.000	1
Totals	N/A	N/A	N/A	599	1.000	50	50

* - The sample size shown applies only to stratified sampling. For simple random sampling, the relative frequencies of occurrence are used.

The failure rates provided in Table B-V are based on predicted values. Dividing the total failure rate of 599 into the individual maintenance task strata rates yields the relative frequencies of occurrence shown in the table. The number of sample tasks to be demonstrated for each strata are determined by multiplying the required sample size, as determined from the chosen demonstration test plan, by the relative frequencies shown in Table B-V. An alternative means of determining sample size would be by random sampling. For this example, where the required sample size is 50, 50 numbers would be drawn from a random-number table, where the numbers are between 0 and 1. If a random number is between 0 and 0.1749, a maintenance task involving the antenna is to be simulated. If the random number is between 0.175 and 0.2579, a fault resulting in the removal and replacement of the I/F module is induced, etc.

As implied, the last column of Table B-V is the number of samples chosen using the stratified approach, exclusively. Within this approach, when a task group consists of more than one module or assembly, etc., as is the case for the amplifier, modulator and power supply group in the R/T, the total number of maintenance tasks assigned to the group (5 in this example) should be allocated to the modules, assemblies, etc., within the group in accordance with the relative frequency of occurrence of maintenance for each module, etc., within the group. The selection process for this group is illustrated as follows:

<u>Group sub-blocks</u>	<u>Total F.R.</u>	<u>Rel. Freq. of Occur.</u>	<u>Demonstration Sample Size</u>
Amplifier	21	0.339	1.7 ~ 2 (.339 x 5 = 1.7)
Modulator	18	0.290	1.4 ~ 1
Power Supply	<u>23</u>	<u>0.371</u>	1.9 ~ <u>2</u>
	62	1.000	5

APPENDIX B

At this point, only the maintenance task sample size by strata have been discussed. To be complete, the demonstration population of maintenance tasks from which to choose the samples must also be determined, as well as the specific maintenance tasks to be sampled from within that population. To minimize any biasing problems due to task rehearsals and the problem of not being able to physically induce a selected fault, it is necessary to select a much larger number of possible tasks than required by the demonstration method. Previous standards (i.e., MIL-STD-471A) have required a number equal to four (4) times the specified sample size, or as specified by the procuring authority. Most of the methods presented in Section 4.0 are based on having a demonstration population of 4 times the specified sample size. For the example Radar system then, 200 sample tasks, or 4 x 50, should be available. This number should then be allocated to the individual groups using the relative frequency of occurrence method just presented. Further allocation within modules of a group is also necessary again, using the relative frequency of occurrence method as illustrated. An entire table for this example, documenting the process of sample task allocation is presented in Table B-VI. This table is summarized in the following 12 step approach, using the R/T as stratified in Table B-V.

Step 1. Column 1 - Identify the major units which comprise the equipment

Step 2. Column 2 - Subdivide each unit to the functional level at which maintenance for the demonstration is to be performed in accordance with the approved maintenance plan. This level may be an assembly, module, printed circuit card or piece part.

Step 3. Columns 3 & 4 - For each functional level of maintenance identified in Column 2, identify in Column 3 the type of maintenance task or tasks to be performed and in Column 4 the estimated mean maintenance time for the task. The maintenance tasks and estimated maintenance time would be derived from a maintenance engineering analysis, a maintainability prediction effort, or from historical data. The same maintenance task, such as "remove and replace" of a module may result from different faults within the module. Column 3 would identify the maintenance task and not the fault or failure which results in the occurrence of the task.

Step 4. Column 5 - Determine the failure rate ($F/10^6$ hours) for each module, printed circuit card, etc., for which the maintenance task was identified in Column 3. The failure rates used should be the latest available from an associated reliability program.

Step 5. Column 6 - Determine the quantity of items in each major unit associated with each task in Column 3.

Step 6. Column 7 - Determine the duty cycle for each item associated with each task in Column 3 (e.g., operating time of a receiver to the operating time of the radar; engine operating hours to aircraft flight hours).

APPENDIX B

TABLE B-VI. Stratification Procedure.

Nomenclature - Radar XYZ												
(1) Major Units	(2) Functional level of Maint.	(3) Maint. Task	(4) Est. Mean Maint Time (hrs.)	(5) Failure Rate F/10 ⁶ hrs.	(6) Quan. of items	(7) Duty Cyc.	(8) Task Groups	(9) Total Failure Rate	(10) Rel. Freq. of Occurrence	(11) Dem. Pop. Alloc.	(12) Demon. Sample Size	(13) Cum. Range Sample
Antenna	Antenna	R/R (A)	1.0	105	1	1.0	Grp. 1 - Task A	105	0.175	35	9	0 - .1749
Receiver/Transmitter	IF -A	R/R (A)	0.3	25	1	1.0	Grp. 2 - Task A, B	50	0.083	17	4	.1750 - .2579
	I/F -B	R/R (B)	0.3	25	1	1.0						
	Amplifier	R/R (C)	0.4	21	1	1.0	Grp. 3 - Task C-E	62	0.104	C-7	C-2	.2580 - .3619
	Modulator	R/R (D)	0.4	18	1	1.0				D-6	D-1	
	Pwr. Supply	R/R (E)	0.4	23	1	1.0				E-8	E-2	
	Transmitter	R/R (F)	0.5	10	1	1.0	Grp. 4 - Task F	10	0.017	3	1	.3620 - .3789
Freq. Tracker	Freq. Tracker	R/R (A)	0.6	400	1	0.7	Grp. 5 - Task A	280	0.467	93	23	.3790 - .8459
		Replace Crystal (B)	0.5	20	4	0.7	Grp. 6 - Task B	56	0.093	19	5	.8460 - .9389
Radar Set Control	Radar Set Control	R/R (A)	0.5	35	1	0.8	Grp. 7 - Task A	28	0.047	9	2	.9390 - .9859
Drift Angle Indicator	Drift Angle Indicator	R/R (A)	0.5	10	1	0.8	Grp. 8 - Task A	8	0.013	3	1	.9860 - 1.0000
								599	1.000	200	50	

Note 1: R/R = remove/replace (includes time to perform each element of maintenance time).

Note 2: This table is for illustration only. It is not intended to represent a complete radar nor should the entries be considered as real data.

Note 3: Delete column 11 and column 12 for sequential test methods.

APPENDIX B

Step 7. Column 8 - Group together the maintenance tasks identified in Column 3 which have both:

a. Similar maintenance actions. NOTE: A maintenance action is an element of a maintenance task. Although the estimated maintenance time for different maintenance tasks may be similar, the actions may be different, that is, one task may involve significant diagnostics and another involve minimum diagnostics but significant access time.

b. Similar estimated maintenance times. The maintenance times in each group should be within a range that shall not exceed the smallest value in the group by more than 50 percent.

Task grouping should be limited to within major units identified in Column 1.

Step 8. Column 9 - Determine the total failure rate for each task grouping identified in Column 8. The total failure rate is equal to the sum of the products of Columns 5, 6 and 7 for all tasks within the group.

Step 9. Column 10 - Determine the relative frequency of occurrence for each task grouping by dividing the sum of the total failure rate (sum of Column 9) into the individual total failure rate for each group.

Step 10. Column 11 - Fixed Sample - A sample of maintenance tasks equal to four times the sample size specified for the selected test method (see Section B.4.0 of this appendix) or as specified or agreed upon with the procuring activity should be allocated among the task groups in accordance with the relative frequency of occurrence of the task group. (For Table B-VI, required sample size = 50, population sample size = $4 \times 50 = 200$).

Step 11. Column 12 - The maintenance tasks to be demonstrated (50 tasks for this example) are allocated among the task groups in accordance with the relative frequency of occurrence of maintenance for the group. The maintenance task to be demonstrated is then randomly selected from the maintenance tasks allocated to the group or modules, assemblies, etc., within the group (Column 11). The maintenance task to be demonstrated is not returned to the sample pool and is therefore demonstrated only once.

Step 12. Column 13 - Variable Sample/Sequential Test - When variable sample size, sequential test methods are employed, a simple random sampling of the total population of maintenance tasks using a random number table based on a uniform distribution from 0 to 1 is used. Using Table B-V, columns 1 through 10, determine from the relative frequency of occurrence (column 10), the cumulative range of frequency of occurrence for each task group. A maintenance task is selected from that group whose cumulative range of frequency of occurrence includes the number selected from the random number table. The number selected from the random number table is then "returned" to the table before selecting a second number. The "specimen" task demonstrated is also returned to the sample pool.

APPENDIX B

B.3.5.2.1 Maintenance Task Selection. The stratification procedure discussed so far only provides a technique for grouping the maintenance tasks by functional blocks or sub-blocks, and determining the population and demonstration sample sizes. However, how to choose samples from the population has yet to be addressed. Table B-VI presents the method whereby the number of maintenance tasks to be simulated is allocated to each group based on the relative frequency of occurrence expected for that group. Within these tasks, there will also be a choice of faults to be simulated. This may involve, for example, the selection of an assembly or part and its mode of failure. As an example, consider the task of choosing which failures to be simulated that will result in a maintenance task for the frequency tracker (FT) block of the Radar system example. The number of failure modes to be considered for the FT should equal at least 93 (see column 11 of Table B-VI) from which 23 failures are to be selected for simulation (see column 12).

As was done to determine the number of tasks to be sampled for Group 3 of Table B-VI, the failure modes for the FT block and their relative frequency of occurrence must be determined such that a random sampling procedure can be applied to select the maintenance tasks to be sampled. This implies that an FMEA for the system be conducted at the level of maintenance to be demonstrated. If these data are not available, an alternate means of choosing samples must be developed.³ As an example, suppose an FMEA of the FT indicates that there are five major failure modes that require a remove and replace action and that are detectable at the unit level. These modes, their effects, and relative frequencies of occurrence are shown in Table B-VII.

TABLE B-VII. Failure Mode Selection.

1 Maintenance Task	2 Failure Mode	3 Effect	4 Relative Frequency of Occurrence (%)	5 Cumulative Range
Frequency Tracker Remove/ Replace	1	Inoperative	30	0 - .2999
	2	Will not lock on	20	.3000 - .4999
	3	Breaks lock	20	.5000 - .6999
	4	Drifts	15	.7000 - .8499
	5	Erratic	15	.8500 - 1.0000

To determine which faults to induce for simulating the 23 tasks, 23 four digit numbers, between 0 and 1, are selected from a random number table. If the number is between 0 and .2999, then a fault or malfunction that makes the FT inoperative must be induced. A random number between .3000 and .4999 would indicate that a fault resulting in inability to lock-on effect is to be simulated, etc.

Within any failure mode, a choice would then have to be made concerning the specific means of fault inducement (e.g., which lead to disconnect or which part to replace with a known faulty part). If, with respect to the maintenance action, there is no discernible difference, the simplest means can be used. If, however, the fault selection can affect maintenance time (e.g.,

³ See the symptom-matrix approach in RADC-TR-69-356.

APPENDIX B

disconnecting one lead may cause secondary symptoms, while disconnecting another will not), then, again, a random-selection criterion could be used, if desired.

The preceding process adds to the previous 12 step process for development of a stratification table. Continuing with step 13, the following steps are added to the entire process of maintenance task selection (refer to Table B-VII.)

Step 13. Column 1 - Identify the maintenance task of interest.

Step 14. Column 2 - Determine the failure modes which will result in the maintenance task of interest.

Step 15. Column 3 - Determine the effect of each failure mode identified in column 2.

Step 16. Column 4 - Determine the relative frequency of occurrence of each failure mode.

Step 17. Column 5 - Simple Random Sampling - Determine the cumulative range of frequency of occurrence for each failure mode. Using a random number table a number is selected and the failure mode to be induced is that whose cumulative range of frequency of occurrence includes the number selected. The number selected from the random number is "returned" to the table before selecting a second number. The specimen demonstrated is also returned to the sample pool.

There are alternative approaches documented for choosing the maintenance tasks to be demonstrated, such as the symptom-matrix approach referenced earlier. However, this approach requires a much more detailed analysis of the system design. Interested readers are encouraged to review the report referenced in the footnotes for more information.

B.3.6 Statistical Maintainability Demonstration Plans. The following subsections contain test methods and criteria for demonstrating the achievement of specified quantitative maintainability requirements. The matrix presented previously in Table B-I is repeated as a summarization of the major characteristics of each test method as well as the quantitative requirements which must be specified for each. The data analysis method included with each test method provides the decision criteria for acceptance or rejection of the item being demonstrated.

Each of the test plans contained in this section includes an equation or other directions for determining a minimum sample size of maintenance tasks. Any departure from the minimum sample size requirements can affect the statistical validity of the test procedures. Some of the test plans require a prior estimate of the variance of the distribution of interest for the calculation of sample size. Such prior estimates are typically obtained from data on similar systems provided similarities in maintainability design, skill levels of maintenance personnel, test equipment, manuals and the maintenance environment are considered in the estimation process. Equations for predicting the variance when prior estimates are not available are presented in RADC-TR-69-356 (see footnotes), which can be used, provided the information needed for the prediction is available. To preserve the desired risk values in those cases where the variance is

APPENDIX B

predicted, the 85th - 95th upper confidence bound on the predicted or estimated variance should be used. Average values of the variance have ranged from 0.5 to 1.3.

Test Method Matrix

Test Plan	Test Index	Assumptions	Sample Size	Sample Selection	Specification Requirement
1-A	Mean	Log-normal dist. and prior knowledge of variance	See test method	Natural occurring failures or stratification ¹	H_0, H_1, α, β
1-B	Mean	No dist. assumption, prior knowledge of variance	See test method	Natural occurring failures or stratification	H_0, H_1, α, β
2	Critical Percentile	Lognormal dist., prior knowledge of variance	See test method	Natural occurring failures or stratification	H_0, H_1, α, β
3	Critical Main. Time or Manhours	None	See test method	Natural occurring failures or stratification	H_0, H_1, α, β
4	Median	A Specific Variance Log-normal	20	Natural occurring failures or stratification	ERT
5 ²	Chargeable maint. Downtime/ Flight	None	See test method	Natural occurring failures	ORR or A, NCMDT/NOF DDT/NOF, α, β
6 ³	Manhour Rate	None	See test method	Natural occurring failures	Manhour Rate ΔMR
7 ⁴	Manhour Rate	None	See test method	Natural occurring failures or stratification	μ_R, α
8	Mean and Percentile	Log-normal	See test method	Natural occurring failures or Simple random sampling	Mean, M_{Max}
	Dual Percentile	None			Dual Percentile
9	Mean (Corrective Task Time, Prev. Maint. Time, Downtime)	None	30 minimum	Natural occurring failures or stratification	$\mu_c, \mu_{pm}, \mu_{p/c},$
	M_{Max} (90 or 95 percentile)				M_{Max_c}
10	Median (Corrective task time, Prev. maint. time), $M_{Max_{ct}}$ (95 percentile), $M_{Max_{pm}}$ (95 percentile)	None	50 minimum	Natural occurring failures or stratification	$\tilde{M}_{ct}, \tilde{M}_{pm}$ $M_{Max_{ct}}, M_{Max_{pm}}$
11	Mean (preventive maint. task time) M_{Max} (preventive maint. task time at any percentile)	None	All possible tasks	All	μ_{pm} $M_{Max_{pm}}$

- Notes for Table B-1: (1) See section 3.3 for stratification method for sample selection
(2) Test method 5 is an indirect method for demonstrating operational ready rate (ORR) or Availability (A).
(3) Test method 6 is intended for use with aeronautical systems and subsystems.
(4) Test method 7 is intended for use with ground electronic systems where it may be necessary to simulate faults.

APPENDIX B

Because of the difficulty in obtaining prior information and estimates of variance, and due to the fact that the mean corrective maintenance time (M_{ct}) and maximum corrective maintenance time ($M_{Max_{ct}}$) have historically been the maintainability requirement most often cited in a procurement specification, test method 9 has been the most chosen method for maintainability demonstration. Note that this method does not rely on any assumptions regarding the distribution of maintenance times. Despite this fact, there are examples when one or more of the other test methods have been employed, and therefore all methods will be given equal consideration in this handbook.

B.3.6.1 Task Selection. Section 3.5.2 presented methods of determining which tasks to be sampled under the fault inducement approach, which are applicable to each of the test methods presented herein. When the demonstration is a requirement of the development program, the procuring activity historically has had the option of surveillance over and/or participation in the random selection of tasks comprising the demonstration population (see Column 11 of Table B-V) down to and including the specific faults to be simulated or induced. It is recommended that this practice continue. Further details on this and other management aspects of maintainability demonstration are contained in Section B.6.0 of this appendix. In all cases, whenever a chosen task can result in events detrimental to safety of personnel or property, appropriate redesign action must take place. In the event that secondary failures result from an induced fault, they should be documented and their impact on item maintainability assessed. A report of such findings is typically made to the procuring activity or demonstration authority.

Two basic types of tests may be used for statistical maintainability demonstration: sequential and non-sequential. In sequential testing, testing continues until a decision to accept or reject the hypothesis under consideration (see Section B.3.1 of this Appendix for discussion of hypothesis testing) can be made. One drawback of sequential testing is that the length of the test cannot be determined in advance. However, sequential testing will accept very low MTTRs or reject very high MTTRs very quickly. A non-sequential, or fixed sample size is best when the maintainability must be demonstrated with a given confidence level.

Whenever sequential test plans are employed (see Test Method 1, for example), care must be exercised in selecting and sampling tasks to insure that a true simple random sample is obtained. Departures from simple random sampling, such as proportionate stratified sampling, can affect the validity of the test procedures presented herein. However, this effect is considered minimal for the sample sizes required by the test procedures that are not sequential tests. In short, simple random sampling must be used for sequential test methods.

B.4.0 Test Methods

In general, the maintainability index to be demonstrated is the primary consideration in selecting a maintainability demonstration test method. Considerable savings in sample size can be obtained

APPENDIX B

by use of sequential test procedures in preference to fixed sample sized tests. As a general rule, however, the sequential test should be used only when prior knowledge (e.g., from the prediction) indicates that the equipment may be much better (or worse) than the specified value.

The justification for use of the log-normal assumption for corrective maintenance time is based on extensive analysis of field data which have shown that the log-normal distribution provides a good fit to the data. However, in some cases it might be suspected that the log-normal assumption does not hold (e.g., equipment with a high degree of built-in diagnostics). When this occurs the log-normal assumption should be tested through the use of goodness of fit tests such as the Chi-square or Kolomogorov-Smirnov. If other distributions also do not fit the data, then a distribution-free method should be employed to ensure preservation of specified risks.

B.4.1 List of Symbols. The following symbols and notations are common to test methods 1 - 3 contained in this appendix:

X = the random variable which denotes the maintenance characteristics of interest (e.g., X can denote corrective maintenance time, preventive maintenance time, fault location time, manhours per maintenance task, etc.).

X_i = the i^{th} observation or value of the random variable X .

n = the sample size.

\bar{X} = the sample mean (i.e., $\bar{X} = \frac{1}{n} \sum_{i=1}^n (X_i)$)

$E(\text{random variable})$ = the expected value of the variable

σ^2 = $E[(\ln X - \theta)^2]$ = the true variance of $\ln X$.

μ = $E(X)$ = the true mean of X .

\hat{d}^2 = $\text{Var}(X) = E[(X - \mu)^2]$ = the true variance of X .

\hat{d}^2 = the sample variance of X (i.e., $\hat{d}^2 = \frac{1}{n-1} \sum_{i=1}^n (X_i - \bar{X})^2 = \frac{1}{n-1} \left(\sum_{i=1}^n X_i^2 - n\bar{X}^2 \right)$)

\tilde{d}^2 = the prior estimate of the variance of the maintenance time.

APPENDIX B

X_p = the (1-p)th percentile of X (i.e., $X_{.05}$ = the 95th percentile of X).

\tilde{M} = $X_{.50}$ = the median of X.

Y = $\ln X$ = the natural logarithm of X.

\bar{Y} = the sample mean of Y

θ = $E(\ln X)$ = the true mean of $\ln X$

$\tilde{\sigma}^2$ = the prior estimate of the variance of the logarithm of maintenance times.

s^2 = the sample variance of $\ln X$.

Z_p = the standardized normal deviate exceeded with probability p (i.e.,

$$\int_{Z_p}^{\infty} \frac{1}{\sqrt{2\pi}} e^{\left(\frac{-Z^2}{2}\right)} dz = p)$$

Z_α = $Z_{(1-\beta)}$ = standardized normal deviate exceeded with probabilities α and $(1-\beta)$ respectively.

α = the producer's risk; the probability that the equipment will be rejected when it has a true value equal to the desired value (H_0).

β = the consumer's risk; the probability that the equipment will be accepted when it has a true value equal to the maximum tolerable value (H_1).

H_0 = the desired value specified in the contract or specification and is expressed as a mean, critical percentile, or critical maintenance time.

H_1 = the maximum tolerable value. Note: $H_0 < H_1$.

When X is a log-normally distributed random variable:

$$f(x) = \frac{1}{\sigma x \sqrt{2\pi}} e^{-1/2\sigma^2 (\ln x - \theta)^2}, \quad 0 < x < \infty$$

If $Y = \ln X$, the probability density of Y is normal with mean θ and σ^2 variance

$$Y \sim N(\theta, \sigma^2)$$

APPENDIX B

Properties of the log-normal distribution:

$$\text{mean} = \mu = e^{\left(\theta + \frac{\sigma^2}{2}\right)}$$

$$\text{variance} = d^2 = e^{\left(2\theta + \sigma^2\right)} \left(e^{\sigma^2} - 1\right)$$

$$\text{median} = \tilde{M} = e^{\theta}$$

$$\text{mode} = M = e^{\left(\theta - \sigma^2\right)}$$

$$(1-p)\text{th percentile} = X_p = e^{\left(\theta + Z_p \sigma\right)}$$

TABLE B-VIII. Standardized Normal Deviates.

P	Z _p
0.01	2.33
0.05	1.65
0.10	1.28
0.15	1.04
0.20	0.84
0.30	0.52

The following symbols are common to test methods 4, 8 - 11 contained in this appendix.

X_{ci} = Maintenance downtime per corrective maintenance task (of the i^{th} task).

X_{pm_i} = Maintenance downtime per preventive maintenance task (of the i^{th} task).

n_c = Number of corrective maintenance tasks sampled.

n_{pm} = Number of preventive maintenance tasks sampled.

β = Consumer's risk

ϕ = That value, corresponding to risk, which is obtained from a table of normal distribution for a one-tail test.

f_c = Number of expected corrective maintenance tasks occurring during a representative operating time (T).

APPENDIX B

- f_{pm} = Number of expected preventive maintenance tasks occurring during a representative operating time (T).
- T = Item representative operating time period.
- D_t = Total maintenance downtime in the representative operating time (T).
- $\bar{X}_c, \bar{X}_{pm}, \bar{X}_{p/c}$ = Mean downtimes of sample. (Corrective, Preventive, and combined Corrective/Preventive Maintenance Times.)
- M'_{Max_c} = Sample calculated maximum corrective maintenance downtime.
- μ_c = Specified mean corrective maintenance time.
- μ_{pm} = Specified mean preventive maintenance time.
- $\mu_{p/c}$ = Specified mean maintenance time. (Taking both corrective and preventive maintenance time into account.)
- M_{Max} = A requirement levied in terms of a maximum value of a percentile of task time (i.e., 95% of all corrective task times must be less than 60 minutes) usually taken as the 90th or 95th percentile.
- M_{Max_c} = Specified M_{Max} of corrective maintenance downtimes.
- $M_{Max_{pm}}$ = Specified M_{Max} of preventive maintenance downtimes.
- θ_c = $E(\ln X_c)$ = Expected value of the logarithm of corrective maintenance tasks.
- $\text{Log } X_{c_i}, \text{Log } X_c$ = Log to the base 10 of X_{c_i}, X_c .
- $\ln X_{c_i}, \ln X_c$ = Natural logs of X_{c_i}, X_c .
- \tilde{M}_{ct} = Median value of corrective maintenance tasks.
- \tilde{M}_{pm} = Median value of preventive maintenance tasks.

B.4.2 TEST METHOD 1: Test On The Mean. This test provides for the demonstration of maintainability when the requirement is stated in terms of both a required mean value (μ_1) and a design goal value (μ_0) (or when the requirement is stated in terms of a required mean value (μ_1) and a design goal value (μ_0) is chosen by the contractor). The test plan is subdivided into two basic procedures, identified herein as Test Plan A and Test Plan B. Test A makes use of the lognormal assumption for determining the sample size, whereas Test B does not. Both tests are fixed sample tests, (minimum sample size of 30), which employ the Central Limit Theorem and the asymptotic normality of the sample mean for their development.

APPENDIX B

ASSUMPTIONS

Test A - Maintenance times can be adequately described by a lognormal distribution. The variance, σ^2 , of the logarithms of the maintenance times is known from prior information or reasonably precise estimates can be obtained.

Test B - No specific assumption concerning the distribution of maintenance times are necessary. The variance d^2 of the maintenance times is known from prior information or reasonably precise estimates can be obtained.

Hypotheses

$$H_0: \text{Mean} = \mu_0 \quad (\text{Equation B-2})$$

$$H_1: \text{Mean} = \mu_1, (\mu_1 > \mu_0) \quad (\text{Equation B-3})$$

Illustration: $H_0: \mu_0 = 30$ minutes
 $H_1: \mu_1 = 45$ minutes

Note that μ_0 is normally the specified maintainability index value, and that μ_1 is typically the maximum acceptable value of the specified index.

SAMPLE SIZE - For a test with producer's risk α and consumer's risk β , the sample size for Test A is given by:

$$n = \frac{(Z_\alpha \mu_0 + Z_\beta \mu_1)^2}{(\mu_1 - \mu_0)^2} (e^{\tilde{\sigma}^2} - 1) \quad (\text{Equation B-4})$$

where $\tilde{\sigma}^2$ is a prior estimate of the variance of the maintenance times and Z_α and Z_β are standardized normal deviates. The sample size for Test B is given by:

$$n = \left(\frac{Z_\alpha + Z_\beta}{\frac{\mu_1 - \mu_0}{\tilde{d}}} \right)^2 \quad (\text{Equation B-5})$$

where \tilde{d}^2 is a prior estimate of the variance of the maintenance times. Z_α and Z_β are standardized normal deviates.

APPENDIX B

Decision Procedure - Obtain a random sample of n maintenance times, X_1, X_2, \dots, X_n , and compute the sample mean,

$$\bar{X} = \frac{1}{n} \sum_{i=1}^n X_i \quad (\text{Equation B-6})$$

and the sample variance

$$\hat{d}^2 = \frac{1}{n-1} \left(\sum_{i=1}^n X_i^2 - n\bar{X}^2 \right) \quad (\text{Equation B-7})$$

Test A: Accept if $\bar{X} \leq \mu_0 + Z_\alpha \frac{\hat{d}}{\sqrt{n}}$ (Equation B-8)

Test B: Accept if $\bar{X} \leq \mu_0 + Z_\alpha \frac{\hat{d}}{\sqrt{n}}$ (Equation B-9)

Reject otherwise

Discussion - By the central limit theorem, the sample mean \bar{X} is approximately normal for large n with mean $E(X)$ and variance $\text{Var}(\bar{X})$. In Test A, under the log-normal assumption $\text{Var}(\bar{X}) = d^2$ where $d^2 = e^{(2\theta + \tilde{\sigma}^2)}(e^{\tilde{\sigma}^2} - 1) = \mu^2 (e^{\tilde{\sigma}^2} - 1)$. Thus the sample size, n , can be computed using a prior estimate of $\tilde{\sigma}^2$. In Test B, a prior estimate of d^2 is assumed to be available to calculate the sample size. A critical value C is chosen such that $\mu_0 + Z_\alpha \sqrt{\text{Var}\bar{X}} = C = \mu_1 - Z_\beta \sqrt{\text{Var}\bar{X}}$. If $\mu = \mu_0$, then $P(\bar{X} > C) = \alpha$ and if $\mu = \mu_1$, then $P(\bar{X} \leq C) = \beta$.

Example - It is desired to test the hypothesis that the mean corrective maintenance time is equal to 30 minutes against the alternate hypothesis that the mean is 45 minutes with $\alpha = \beta = 0.05$.

Then $H_0: \mu_0 = 30$ minutes.

$H_1: \mu_1 = 45$ minutes.

Test A: Under the log-normal assumption with prior estimate of $\tilde{\sigma}^2 = 0.6$, the sample size using equation B-4 is: $n_c = \frac{[1.65(30) + 1.65(45)]^2}{(45 - 30)^2} (e^{0.6} - 1) = 56$.

APPENDIX B

Test B: Under the distribution-free case with a prior estimate of $\tilde{d}^2 = 900$, (or $\tilde{d} = 30$), the sample size using equation B-5 is:

$$n_c = \left[\frac{3.29}{\left(\frac{45 - 30}{30} \right)} \right]^2 = 43$$

Operating Characteristic (OC) Curve - The OC curve for Test B for this example is given in Figure B-4. It gives the probability of acceptance for values of the mean maintenance time from 20 to 60 minutes. The OC curve for Test A for this example is given in Figure B-3. It gives the probability of acceptance for various values of the mean maintenance time. Thus, if the true value of μ is 40 minutes, then the probability that a demonstration will end in acceptance is 0.21 as seen from Figure B-3.

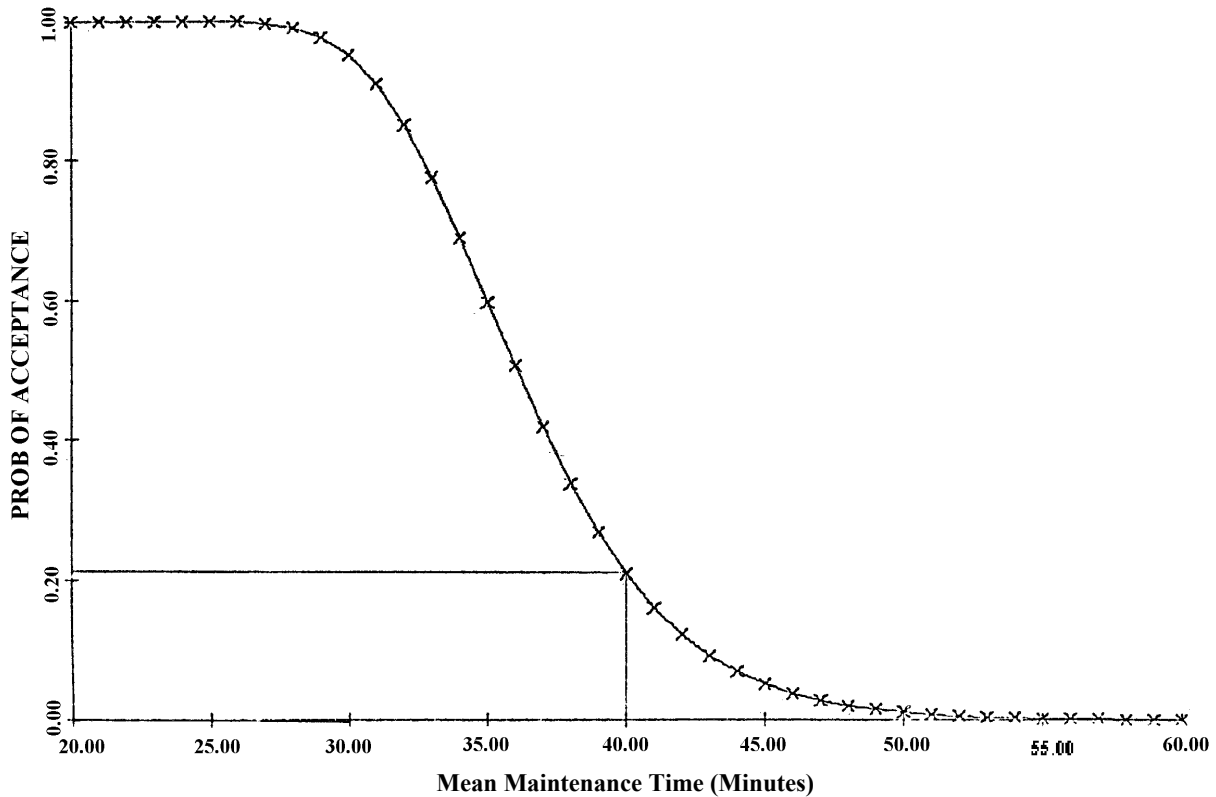

FIGURE B-3. OC Curve for Test A.

APPENDIX B

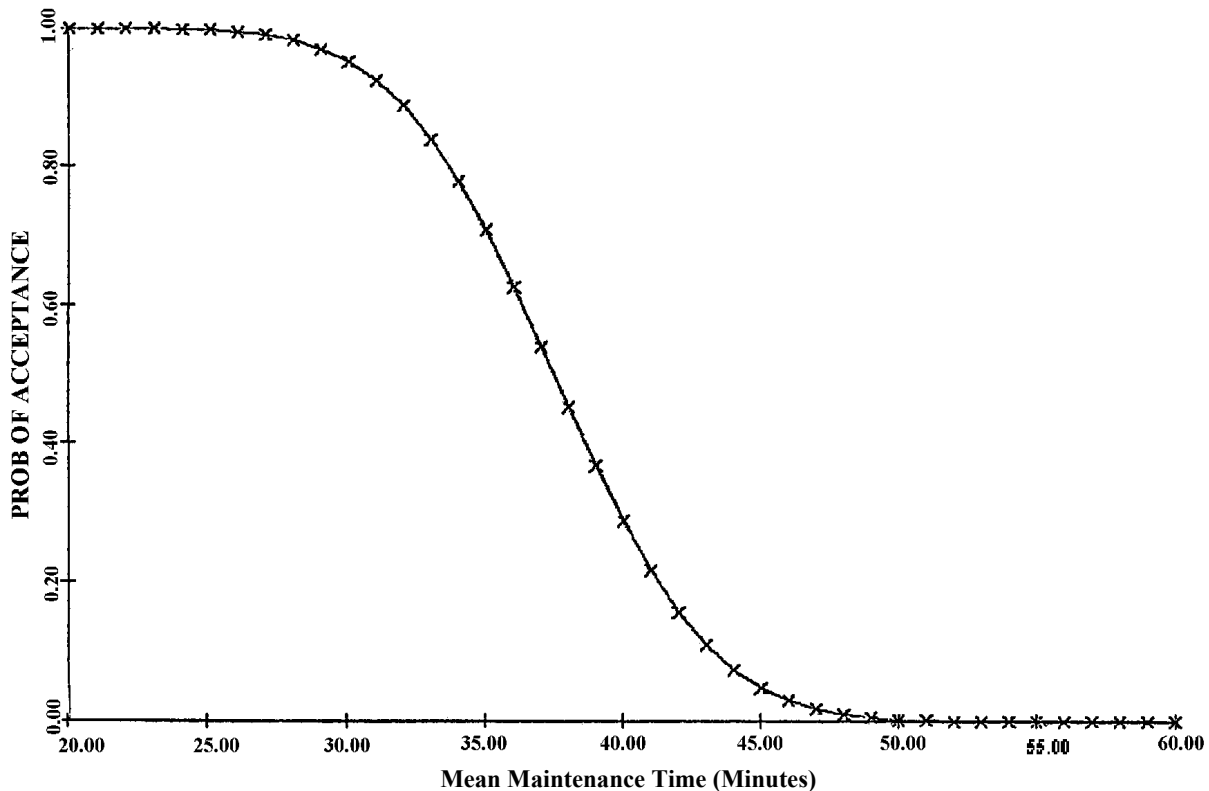

FIGURE B-4. OC Curve for Test B.

B.4.3 TEST METHOD 2: Test On Critical Percentile. This test provides for the demonstration of maintainability when the requirement is stated in terms of both a required critical percentile value (T_1) and a design goal value (T_0) [or when the requirement is stated in terms of a required percentile value (T_1) and a design goal value (T_0) is chosen by the system developer]. If the critical percentile is set at 50 percent, then this test method is a test of the median. The test is a fixed sample size test. The decision criterion is based upon the asymptotic normality of the maximum likelihood estimate of the percentile value.

ASSUMPTIONS - Maintenance times can be adequately described by a log-normal distribution. The variance, σ^2 , of the logarithms of the maintenance times is known from prior information or reasonably precise estimates can be obtained.

HYPOTHESES

$$H_0: (1-p)\text{th percentile, } X_p = T_0 \quad (\text{Equation B-10})$$

$$\text{or } P[X > T_0] = p$$

$$H_1: (1-p)\text{th percentile, } X_p = T_1 \quad (\text{Equation B-11})$$

$$\text{or } P[X > T_1] = p, (T_1 > T_0)$$

APPENDIX B

Illustration: H_0 : 95th percentile = $X_p = X_{.05} = T_0 = 1.5$ hours

$$\ln T_0 = 0.4055$$

H_1 : 95th percentile = $X_p = X_{.05} = T_1 = 2$ hours

$$\ln T_1 = 0.6932$$

SAMPLE SIZE - To meet specified α and β risks, the sample size to be used is given by the formula

$$n = \left(\frac{2 + Z_p^2}{2} \right) \tilde{\sigma}^2 \left(\frac{Z_\alpha + Z_\beta}{\ln T_1 - \ln T_0} \right)^2 \quad (\text{Round up to next integer}) \quad (\text{Equation B-12})$$

where:

$\tilde{\sigma}^2$ is a prior estimate of σ^2 , the true variance of the logarithms of the maintenance times.

Z_p is the standardized normal deviate corresponding to the (1-p)th percentile.

DECISION PROCEDURE - Compute:

$$\bar{Y} = \frac{1}{n} \sum_{i=1}^n \ln X_i \quad (\text{Equation B-13})$$

$$s^2 = \frac{1}{n-1} \left[\sum_{i=1}^n (\ln X_i)^2 - n \bar{Y}^2 \right] \quad (\text{Equation B-14})$$

$$X^* = \ln T_0 + Z_\alpha s \left[\frac{1}{n} + \frac{Z_p^2}{2(n-1)} \right]^{1/2} \quad (\text{Equation B-15})$$

$$\text{Accept if } \bar{Y} + Z_p s \leq X^* \quad (\text{Equation B-16})$$

Reject otherwise.

DISCUSSION - This test is based upon the fact that under the log-normal assumption, the (1-p)th percentile value is given by $X_p = e^{(\theta + Z_p \sigma)}$. Taking logarithms gives $\ln X_p = \theta + Z_p \sigma$, and using maximum likelihood estimates for the normal parameters θ and σ , the (1-p)th percentile maximum likelihood estimate is $\ln \hat{X}_p = \bar{Y} + Z_p \sigma \sqrt{\frac{n-1}{n}}$. $\ln X_p$ is approximately normal. To meet the producer's risk requirements, a critical value X^* is chosen for the sample estimate of the (1-p)th percentile X_p . Note $\bar{Y} = \hat{\theta}$ is an estimate for θ .

APPENDIX B

Example - The following hypotheses are to be tested at $\alpha = \beta = .10$.

$$H_0: 95\text{th percentile} = X_{.05} = 1.5 \text{ hours} = T_0; \ln T_0 = .4055$$

$$H_1: 95\text{th percentile} = X_{.05} = 2.0 \text{ hours} = T_1; \ln T_1 = .6932$$

A prior estimate of $\tilde{\sigma}^2$ is equal to 1.0. Using equation B-12,

$$n_c = \left(\frac{2 + (1.65)^2}{2} \right) 1.0 \frac{(2.65)^2}{(\ln 2.0 - \ln 1.5)^2}$$

$$= 187$$

The critical value X^* is given by equation B-15,

$$X^* = \ln T_0 + Z_{\alpha} s \left[\frac{1}{n} + \frac{Z_p^2 p}{2(n-1)} \right]^{1/2}$$

$$= \ln 1.5 + 1.28s \left[\frac{1}{187} + \frac{(1.65)^2}{372} \right]^{1/2}$$

$$= .4055 + .1437s$$

OC Curve - The OC curve for Test Method 2 for this example is given in Figure B-5. It gives the probability of acceptance for various values of the 95th percentile of the maintenance time distribution. If the true value of $X_{0.05}$ is 1.7 hours, then the probability that a demonstration will end in acceptance is 0.57 as seen from Figure B-5.

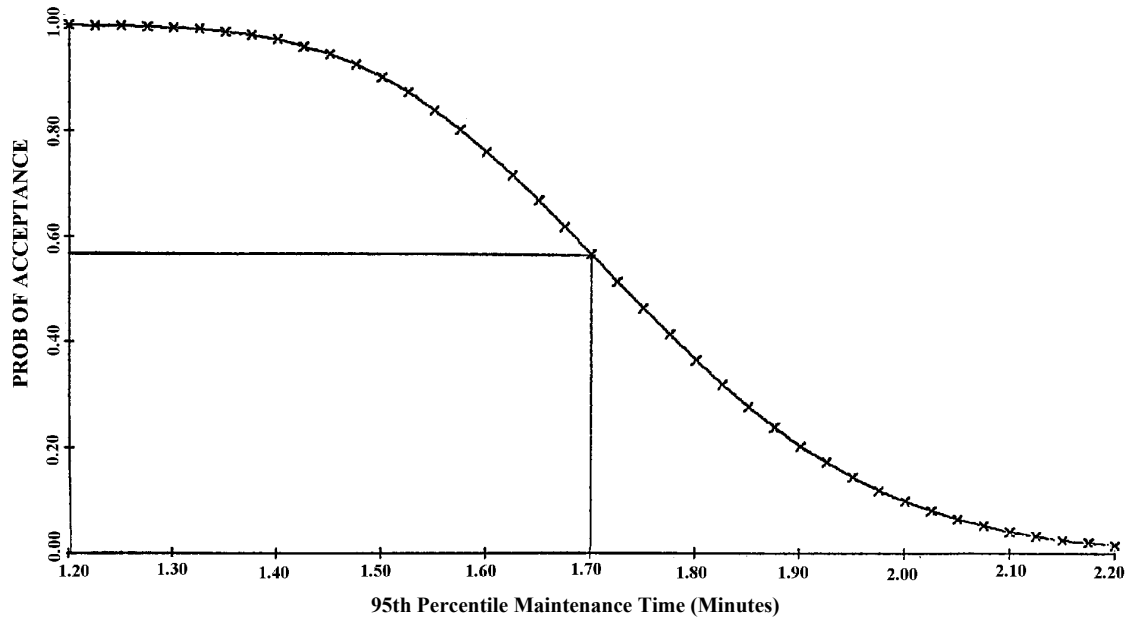

FIGURE B-5. OC Curve for Test Method 2.

APPENDIX B

B.4.4 TEST METHOD 3: Test On Critical Maintenance Time Or Manhours. This test provides for the demonstration of maintainability when the requirement is specified in terms of both a required critical maintenance time (or critical manhours) (X_{p_1}) and a design goal value (X_{p_0}) (or when the requirement is stated in terms of a required critical maintenance time (X_{p_1}) and a design goal value (X_{p_0}) is chosen by the system developer). The test is distribution-free and is applicable when it is desired to establish controls on a critical upper value on the time or manhours to perform specific maintenance tasks. In this test both the null and alternate hypothesis refer to a fixed time and the percentile varies. It is different from Test Method 2 where the percentile value remains fixed and the time varies.

ASSUMPTIONS - No specific assumption is necessary concerning the distribution of maintenance time or manhours.

HYPOTHESES

$$H_0: T = X_{p_0} \quad (\text{Equation B-17})$$

$$(p_1 > p_0)$$

$$H_1: T = X_{p_1} \quad (\text{Equation B-18})$$

For a specified α and β .

Illustration

$$H_0: 30 \text{ minutes} = X_{0.50} = 50\text{th percentile (median)}$$

$$H_1: 30 \text{ minutes} = X_{0.75} = 25\text{th percentile}$$

SAMPLE SIZE, n, AND ACCEPTANCE NUMBER, c - The normal approximation to the binomial distribution is employed to find n and c when p_0 is not a small value. Otherwise, the Poisson approximation is employed. The equations for n and c are as follows:

For $0.20 < p_0 < 0.80$ ($p_i = 1 - Q_i$),

$$n = \left[\frac{Z_\beta \sqrt{p_1 Q_1} + Z_\alpha \sqrt{p_0 Q_0}}{p_1 - p_0} \right]^2 \quad (\text{Use next higher integer value.}) \quad (\text{Equation B-19})$$

$$c = n \left[\frac{Z_\beta p_0 \sqrt{p_1 Q_1} + Z_\alpha p_1 \sqrt{p_0 Q_0}}{Z_\alpha \sqrt{p_0 Q_0} + Z_\beta \sqrt{p_1 Q_1}} \right] \quad (\text{Use next lower integer value.}) \quad (\text{Equation B-20})$$

APPENDIX B

For $p_0 < 0.20$, n and c can be found from the following two equations:

$$\sum_{r=0}^c \frac{e^{-np_0} (np_0)^r}{r!} \geq 1 - \alpha \quad (\text{Equation B-21})$$

$$\sum_{r=0}^c \frac{e^{-np_1} (np_1)^r}{r!} \leq \beta \quad (\text{Equation B-22})$$

Table B-IX provides sampling plans for various α and β risks and ratios p_1/p_0 when $p_0 < 0.20$.

Decision Procedure - Random samples of maintenance times are taken, yielding n observations X_1, X_2, \dots, X_n . The number of such observations exceeding the specified time T is counted. This number is called r .

$$\text{Accept } H_0 \text{ if } r \leq c. \quad (\text{Equation B-23})$$

$$\text{Reject } H_0 \text{ if } r > c. \quad (\text{Equation B-24})$$

Example - A median value of 30 minutes is considered acceptable whereas if 30 minutes is the 25th percentile then this is considered unacceptable. The following hypotheses result:

$$H_0: \quad 30 \text{ minutes} = X_{0.50} = 50\text{th percentile (median)}$$

$$H_1: \quad 30 \text{ minutes} = X_{0.75} = 25\text{th percentile}$$

$$\alpha = \beta = .10$$

Then, $Z_\alpha = Z_\beta = 1.28$, $p_0 = 0.50$, $p_1 = 0.75$. Using equations B-19 and B-20:

$$n = (1.28)^2 \left[\frac{\sqrt{(.75)(.25)} + \sqrt{(.50)(.50)}}{(.25)} \right]^2 \approx 23$$

and,

$$c = 23 \left[\frac{1.28(0.5)\sqrt{(.75)(.25)} + 1.28(.75)\sqrt{(.50)(.50)}}{1.28\sqrt{(.50)(.50)} + 1.28\sqrt{(.75)(.25)}} \right] \approx 14$$

APPENDIX B

TABLE B-IX. Sampling Plans for Specified p_0 , p_1 , α , and β When p_0 is Small (e.g., $p_0 < 0.20$).

$k = \frac{p_1}{p_0}$	$\alpha = 0.05$						$\alpha = 0.10$						$\alpha = 0.20$					
	$\beta = 0.05$		$\beta = 0.10$		$\beta = 0.20$		$\beta = 0.05$		$\beta = 0.10$		$\beta = 0.20$		$\beta = 0.05$		$\beta = 0.10$		$\beta = 0.20$	
	c	D	c	D	c	D	c	D	c	D	c	D	c	D	c	D	c	D
1.5	66	54.1	54	43.4	39	30.2	51	43.0	40	33.0	29	23.2	36	31.8	27	23.5	17	14.4
2	22	15.7	18	12.4	14	9.25	17	12.8	14	10.3	10	7.02	12	9.91	9	7.29	6	4.73
2.5	13	8.46	10	6.17	8	4.70	10	7.02	8	5.43	6	3.90	7	5.58	5	3.84	3	2.30
3	9	5.43	7	3.98	6	3.29	7	4.66	5	3.15	4	2.43	4	3.09	3	2.30	2	1.54
4	6	3.29	5	2.61	4	1.97	4	2.43	3	1.75	2	1.10	3	2.30	2	1.54	1	0.824
5	4	1.97	3	1.37	3	1.37	3	1.75	2	1.10	2	1.10	2	1.54	1	0.824	1	0.824
10	2	0.818	2	0.818	1	0.353	1	0.532	1	0.532	1	0.532	1	0.824	1	0.824	0	0.227

To find the sample size n , for given p_0 , p_1 , α , and β , divide the appropriate D value by p_0 and use the greatest integer less than the quotient. Example: $p_0 = 0.05$, $p_1 = 0.20$, $\alpha = 0.10$, $\beta = 0.05$. Then $k = \frac{0.20}{0.05} = 4$ and $n = \frac{D}{0.05} = \frac{2.43}{0.05} = 48$. The acceptance number is $c = 4$.

APPENDIX B

OC Curve - The OC curve for Test Method 3 for this example is given in Figure B-6. It gives the probability of acceptance for values of probability p , varying from 0.3 to 1.0. Here X_p is the $(1-p)$ th percentile. Thus, if the true value of the given critical maintenance time is the 40th percentile, i.e., if the value of p is 0.6, then the probability that a demonstration will end in acceptance is 0.61 as seen from Figure B-6.

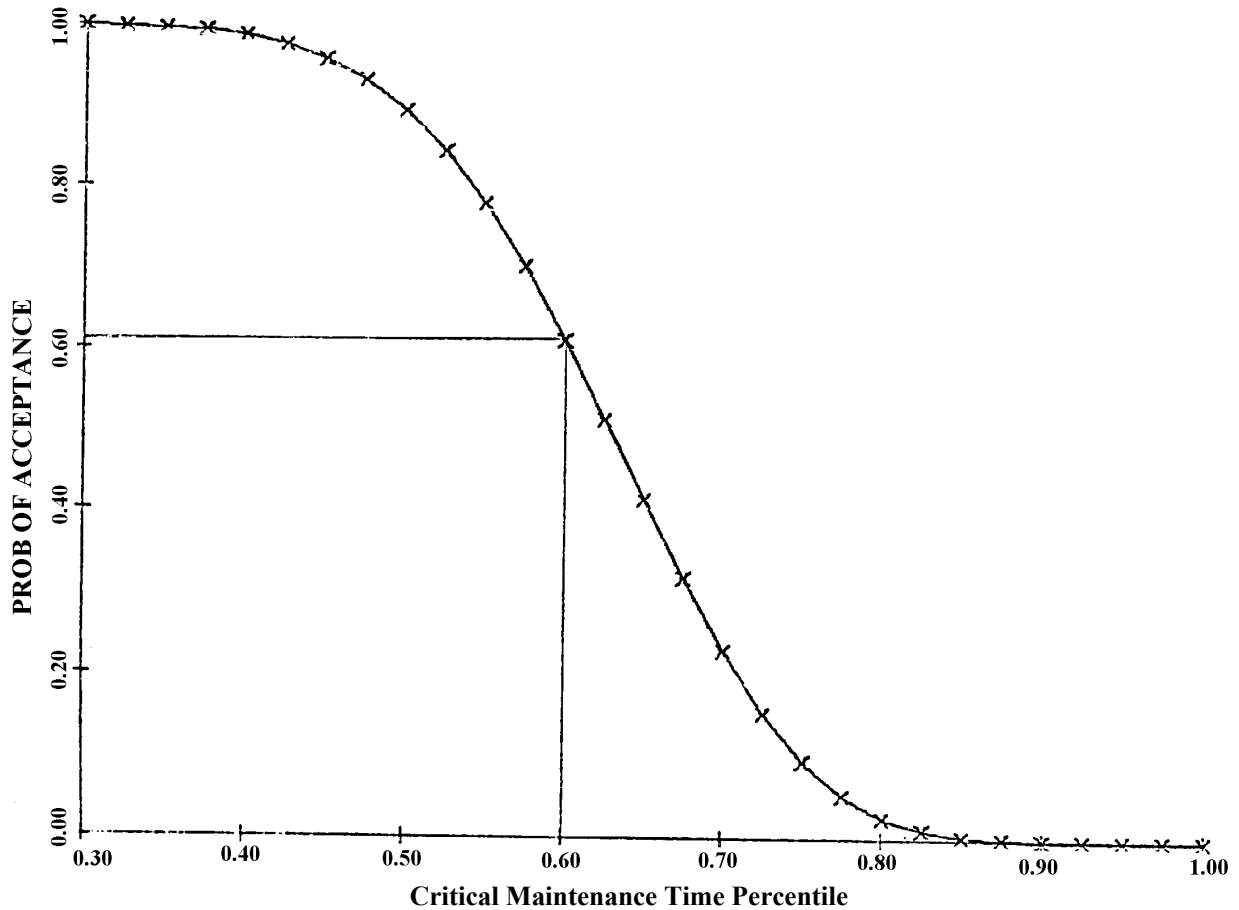

FIGURE B-6: OC Curve for Test Method 3.

B.4.5 TEST METHOD 4: Test On The Median (ERT). This method provides for demonstration of maintainability when the requirement is stated in terms of an Equipment Repair Time (ERT) median, which will be specified in the detailed equipment specification.

ASSUMPTION - This method assumes the underlying distribution of corrective maintenance task times is lognormal.

SAMPLE SIZE - The sample size required is 20. This sample size must be used to employ the equation described in this test method.

APPENDIX B

TASK SELECTION AND PERFORMANCE - Sample tasks are selected in accordance with the stratification procedure outlined in Section 3.5.2. The duration of each task is recorded and used to compute the following statistics:

$$\text{Log MTTR}_G = \frac{\sum_{i=1}^{n_c} (\text{Log} X_{c_i})}{n_c} \quad (\text{Equation B-25})$$

$$S = \sqrt{\frac{\sum_{i=1}^{n_c} (\log X_{c_i})^2}{n_c} - (\log \text{MTTR}_G)^2} \quad (\text{Equation B-26})$$

(Note: All logarithms in equations B-25 and B-26 are to be taken to the base 10.)

Where: MTTR_G is the measured geometric mean time to repair. It is the equivalent to the \tilde{M}_{ct} used in other plans included in this document.

DECISION PROCEDURE - The equipment under test will be considered to have met the maintainability requirement (ERT) when the measured geometric mean-time-to-repair (MTTR_G) and standard deviation (S) as determined in equation B-26 above satisfies the following expression:

$$\text{Accept if } \log \text{MTTR}_G \leq \log \text{ERT} + 0.397(S) \quad (\text{Equation B-27})$$

where:

- $\log \text{ERT}$ = logarithm of the equipment repair time
- $\log \text{MTTR}_G$ = the value determined in accordance with equation B-25
- S = the value determined in accordance with equation B-26

DISCUSSION - The value of equipment repair time (ERT) to be specified in the detailed equipment specification should be determined using the following expression:

$$\text{ERT (specified)} = 0.37 \text{ERT}_{\max} \quad (\text{Equation B-28})$$

ERT_{\max} = the maximum value of ERT that should be accepted no more than 10 percent of the time.

0.37 = σ value resulting from application of "student's t" operating characteristic that assures a 95 percent probability that an equipment having an acceptable ERT will not be rejected as a result of the maintainability test when the sample size is 20, and assuming a population standard deviation (σ) of 0.55.

APPENDIX B

DERIVATION OF CRITERIA - The following are brief explanations of the derivations of various criteria specified herein, and are intended for information purposes only. The acceptance criterion, $\log \text{MTTR}_G \leq \log \text{ERT} + 0.397(S)$, assures a probability of 0.95 of accepting an equipment or system as a result of one test when the true geometric mean-time-to-repair is equal to the specified equipment repair time (that is, a probability of 0.05 of rejecting an equipment or system having a true MTTR_G equal to the specified ERT). This was derived by using conventional methods for establishing acceptance criteria. The conventional methods for determining acceptance based on the measured mean of a small sample (that is, sample size less than 30), and when the true standard deviation (σ) of the population can only be estimated, is to compare the measured mean with the desired mean using the expression:

$$t = \frac{(\bar{x} - \bar{x}_0)}{S} \sqrt{n_c - 1} \quad (\text{Equation B-29})$$

where:

$$S = \sqrt{\frac{\sum_i (x_i - \bar{x})^2}{n_c}} \text{ or the standard deviation of the sample}$$

\bar{x} = the sample or measured mean
 \bar{x}_0 = the specified or desired mean
 n_c = the sample size
 x_i = the value of one measurement of the sample

The decision to accept the product will be made when the test results give a value of t , as calculated for the above expression, numerically less than or equal to a value of t obtained from "student's t " distribution tables at the established level (that is, 0.99, 0.95, 0.90, etc.) of acceptance and the appropriate sample size. The "student's t " distribution tables (for a single tailed area) give a value to $t=1.729$ at the 0.95 acceptance level when the sample size is 20 (that is, 19 degrees of freedom). The table for single tailed area is used since only values of MTTR_G greater than the specified ERT are critical. An equipment with any value of MTTR_G lower than the specified ERT is acceptable. To apply the expression for " t " to the maintainability test, let $\bar{x}_0 = \log \text{ERT}$ (specified), $\bar{x} = \log \text{MTTR}_G$ (measured), S = the measured standard deviation of the logarithms of the sample of measured repair time, and n_c = the sample size of 20. The measured MTTR_G is then compared to the desired ERT by calculating the value of t using the expression below:

$$t = \frac{(\log \text{MTTR}_G - \log \text{ERT})}{S} \sqrt{19}$$

The equipment under test can be acceptable if the value of t calculated from the expression above is equal to or less than +1.729 (the value of t from the "Student's t " distribution tables at an

APPENDIX B

acceptable level of 0.95 when the sample size is 20). Therefore, the equipment should be accepted when:

$$\sqrt{19} \frac{(\log \text{MTTR}_G - \log \text{ERT})}{S} \leq +1.729.$$

Upon rearranging and simplifying the above expression, the acceptance criterion is obtained as shown below:

$$\log \text{MTTR}_G - \log \text{ERT} \leq \frac{1.729(S)}{\sqrt{19}}$$

$$\log \text{MTTR}_G \leq \log \text{ERT} + 0.397(S)^4$$

B.4.6 TEST METHOD 5: Test on Chargeable Maintenance Downtime per Flight.

Because of the relatively small size of the demonstration fleet of aircraft and administrative and operational differences between it and fully operational units, operational ready rate or availability cannot be demonstrated directly. However, a contractual requirement for chargeable downtime per flight can be derived analytically from an operational requirement of operational ready rate (ORR) or availability. This chargeable downtime per flight can be thought of as the allowable time (hours) for performing maintenance given that the aircraft has levied on it a certain availability or operational ready requirement. The requirement for chargeable downtime per flight will be established using the procedure presented within this section.

DEFINITIONS - The following definitions apply to this test method:

A = Availability - A measure of the degree (expressed as a probability) to which an aircraft is in the operable and committable state at the start of the mission, when the mission is called for at an unknown (random) point in time. For this test method, availability is considered synonymous with operational readiness. The aircraft is not considered to be in an operable and committable state when it is being serviced and is undergoing maintenance.

TOT = Total Active Time in Hours.

Active Time = That time during which an aircraft is assigned to an organization for the purpose of performing the organizational mission. It is time during which:

1. The aircraft is flying or ready to fly.
2. Maintenance is being performed.
3. Maintenance is delayed for supply or administrative reasons.

⁴ Reference - "Introduction to Mathematical Statistics," P. Hoel, J. Wiley and Sons, Inc., 2nd Edition, 1954, pp. 222-229)

APPENDIX B

DUR = Daily Utilization Rate - The number of flying hours per day.

AFL = Average Flight Length - Flying hours per flight.

NOF = Number of Flights per day.

DT = Downtime - Time (in hours) during which the aircraft is not ready to commence an assigned mission (i.e., have the flight crew aboard the aircraft).

CMDT = Chargeable Maintenance Downtime - Time (in hours) during which maintenance personnel are working on the aircraft, except when the only work being done would fall under the nonchargeable maintenance downtime (NCMDT) category.

NCMDT = Nonchargeable Maintenance Downtime - Time (in hours) during which the aircraft is not available for immediate flight but the only maintenance being performed is not chargeable. It would include the following:

1. To correct maintenance or operational errors not attributable to technical orders, contractor furnished training or faulty design.
2. Miscellaneous tasks such as keeping of records or taxiing or towing the aircraft to or from other than the work center area.
3. Repair of accident or battle damage.
4. Modification tasks.
5. Maintenance caused by test instrumentation.

DDT = Delay Downtime - Downtime (in hours) during which maintenance is required but no maintenance is being performed on the aircraft for supply or administrative reasons. It would include the following:

1. Supply Delay Downtime.
 - a. Not Operationally Ready Supply (NORS) time.
 - b. Item obtainment time from other than the work center area.
2. Administrative Delay Downtime.
 - a. Personal breaks such as coffee or lunch.
 - b. No maintenance people available for administrative reasons.

APPENDIX B

α = the producer's risk: The risk that the producer (or supplier) must take that the hypothesis that a true mean = M_0 will be rejected even though it is true. The desirable value of α must be determined by judgment and agreed upon by the procuring activity and the systems developer. All other things being equal, a smaller value of α will require a larger sample size.

M = The maximum mean chargeable maintenance downtime per flight.

M_0 = The required mean CMDT per flight.

$M - M_0$ = The difference between the maximum mean (M) of the parameter being tested and the specified mean (M_0). This value must be determined in conjunction with a value for β , the consumer's risk. M is a value, greater (or worse) than the specified mean, which the consumer is willing to accept, but only with a small risk or probability (β). If the true mean is in fact equal to the value of M selected, the hypothesis the true mean = M_0 will be accepted, although erroneously, 100 β percent of the time.

β = The consumer's risk. The risk, which the consumer is willing to take, of accepting the hypothesis that the true mean = M_0 when in fact the true mean = M. All other things being equal, a smaller value of β will require a larger sample size.

σ = The true standard deviation of the parameter (CMDT per flight) being tested. *This value, unless it is a specification requirement, will not be known, but an estimate must be made.* (It is assumed that both M and M_0 will have the same value of σ .) The developer's maintainability math model, previous models, or previous data may be used. All other things being equal, a larger value of σ will require a larger sample size.

ASSUMPTIONS - This method requires no assumption as to the probability distribution of chargeable downtime per flight. The method is valid only if the Central Limit Theorem applies, which means that the sample size (number of flights) must be large enough for this theorem to apply. *The sample size must be at least 50, but the actual size is to be determined in accordance with equation B-39.*

DERIVATION OF CMDT PER FLIGHT FROM AVAILABILITY - The requirement for CMDT per flight which will be demonstrated will be determined using the following mathematical derivation.

$$A = 1 - \frac{\text{CMDT} + \text{NCMDT} + \text{DDT}}{\text{TOT}} \quad (\text{Equation B-30})$$

$$A(\text{TOT}) = \text{TOT} - \text{CMDT} - \text{NCMDT} - \text{DDT} \quad (\text{Equation B-31})$$

$$\text{CMDT} = \text{TOT} - A(\text{TOT}) - \text{NCMDT} - \text{DDT} \quad (\text{Equation B-32})$$

APPENDIX B

$$\frac{\text{CMDT}}{\text{NOF}} = \frac{\text{TOT} - A(\text{TOT}) - \text{NCMDT} - \text{DDT}}{\text{NOF}} \quad (\text{Equation B-33})$$

but,

$$\text{NOF} = \frac{\text{TOT}(\text{DUR})}{24(\text{AFL})} \quad (\text{Equation B-34})$$

therefore,

$$\frac{\text{CMDT}}{\text{NOF}} = \frac{24(\text{AFL})}{\text{DUR}} - \frac{A(24)(\text{AFL})}{\text{DUR}} - \frac{\text{NCMDT}}{\text{NOF}} - \frac{\text{DDT}}{\text{NOF}} \quad (\text{Equation B-35})$$

$$\frac{\text{CMDT}}{\text{NOF}} = \text{CMDT per flight, which will be demonstrated.}$$

Values for DUR and AFL should be those planned for the aircraft during operational use. Values for $\frac{\text{NCMDT}}{\text{NOF}}$ and $\frac{\text{DDT}}{\text{NOF}}$ are a function of the operational environment. They should be provided to the system developer in the RFP or, if not, must be provided by the developer in his proposal. The value for availability or operational ready rate should be provided in the RFP.

Example - Following is an example of how a requirement for CMDT per flight $\left(\frac{\text{CMDT}}{\text{NOF}}\right)$ will be derived:

Required A = 0.75

DUR = 2 hours per day

AFL = 4 hours per flight

$\frac{\text{NCMDT}}{\text{NOF}} = 0.2$ hours per flight

$\frac{\text{DDT}}{\text{NOF}} = 1.0$ hours per flight

Then,

$$\frac{\text{CMDT}}{\text{NOF}} = \frac{24(4)}{2} - \frac{(0.75)(24)(4)}{2} - 0.2 - 1.0$$

$$\frac{\text{CMDT}}{\text{NOF}} = 48 - 36 - 0.2 - 1.0$$

$$\frac{\text{CMDT}}{\text{NOF}} = 10.8 \text{ hours per flight}$$

APPENDIX B

SAMPLE SIZE - Since the Central Limit Theorem is applied, the expected distribution of the means will take on a normal distribution as in Figure B-7. If the true mean is equal to M_0 and a particular α is desired, the upper distribution (the mean of the distribution will equal M_0) will apply. It is on this basis that an acceptance rule is generated to the effect that if \bar{X} is found to be equal to or less than the value $M_0 + \frac{Z_\alpha \sigma}{\sqrt{n}}$ the item is to be accepted.

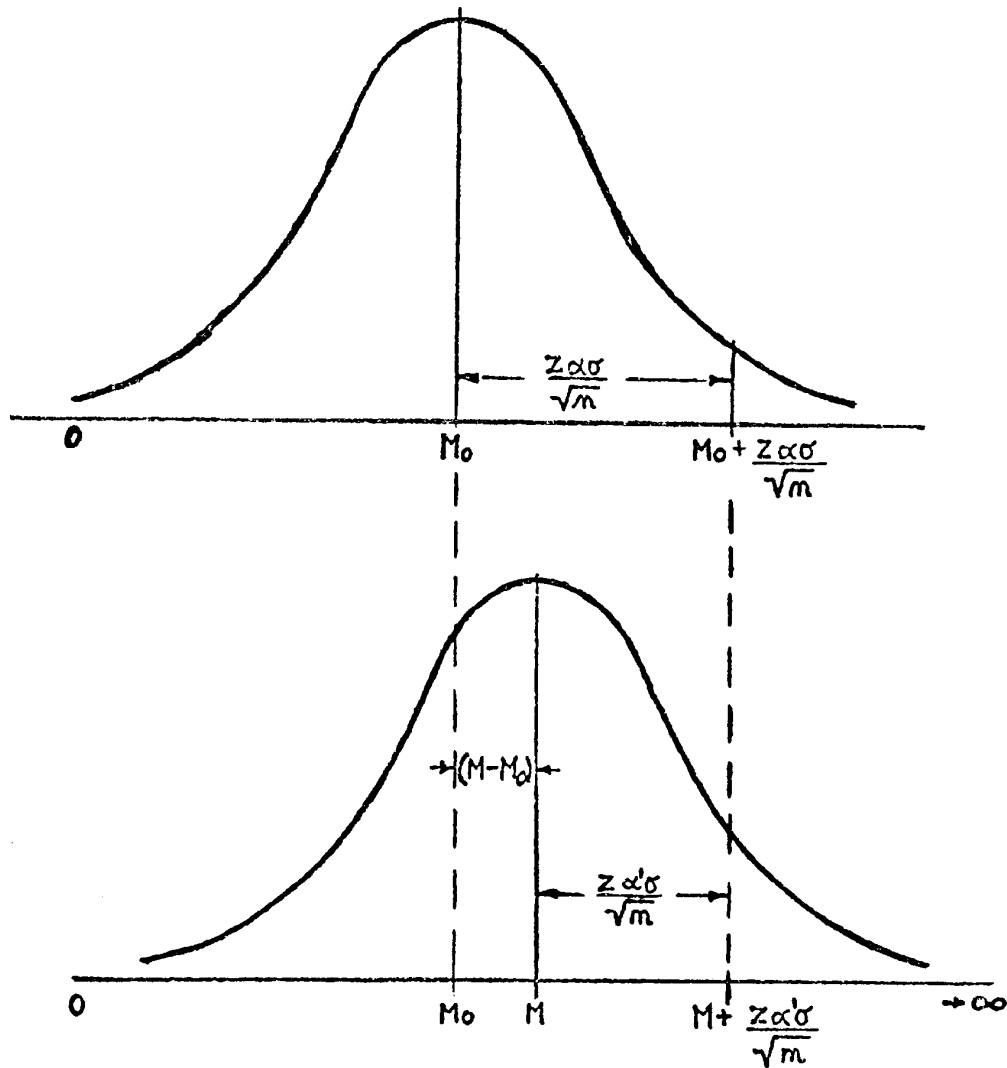

Where: $\left(M + \frac{Z_\alpha' \sigma}{\sqrt{m}} \right)$
 corresponds to the value
 $\left(M_0 + \frac{Z_\alpha \sigma}{\sqrt{m}} \right)$

FIGURE B-7. Distribution of Means.

APPENDIX B

If the true mean is equal to M (which is greater than M_0) the distribution of means will take on a normal distribution with a mean of M as shown in the lower distribution. The value to be used as an acceptance criterion, $M_0 + \frac{Z_{\alpha}\sigma}{\sqrt{n}}$, corresponds and is equal to a value:

$$M + \frac{Z_{\alpha'}\sigma}{\sqrt{n}}; \text{ where } \alpha' \text{ is a new confidence level}$$

$$M_0 + \frac{Z_{\alpha}\sigma}{\sqrt{n}} = M + \frac{Z_{\alpha'}\sigma}{\sqrt{n}}; \tag{Equation B-36}$$

$$\text{where } M = M_0 + (M - M_0) \tag{Equation B-37}$$

$$M_0 + \frac{Z_{\alpha}\sigma}{\sqrt{n}} = M_0 + M - M_0 + \frac{Z_{\alpha'}\sigma}{\sqrt{n}} \tag{Equation B-38}$$

or simplifying, the sample size (n) requirement is:

$$n = \frac{(Z_{\alpha} - Z_{\alpha'})^2}{\left(\frac{M - M_0}{\sigma}\right)^2} = \frac{(Z_{\alpha} - Z_{(1-\beta)})^2}{\left(\frac{M - M_0}{\sigma}\right)^2} \tag{Equation B-39}$$

If this expression should result in n less than 50, then a sample of 50 must be used.

α = Probability of rejection if true mean equals M.

$1 - \alpha' = \beta$ = Probability of acceptance if true mean equals M.

$Z_{\alpha}, Z_{(1-\beta)}$ = standardized normal deviate as defined.

See table below for relationships between Z_w and α and β , where $w = \alpha$ or $1 - \beta$.

Z_w	.01	.05	.1	.15	.2	.3	.7	.8	.85	.9	.95	.99
	2.33	1.65	1.28	1.04	.84	.52	-.52	-.84	-1.04	-1.28	-1.65	-2.33

$$Z_w = Z_{\alpha} \text{ or } Z_{(1-\beta)}$$

Example - Suppose for a requirement of $M_0 = 2.0$, the following statistical test parameters were agreed to by the procuring activity and the system developer:

$$\alpha = 0.10; Z_{\alpha} = 1.28; \beta = 0.10; Z_{1-\beta} = -1.28; M - M_0 = 0.30; \sigma = 1.0; \frac{M - M_0}{\sigma} = 0.3$$

APPENDIX B

$$\text{Using equation B-39: } n = \frac{(1.28 + 1.28)^2}{(0.3)^2} = \frac{(2.56)^2}{(0.3)^2} = \frac{6.57}{0.09} = 73$$

Decision Procedure - The chargeable maintenance downtime (X_i) after each flight will be measured and, at the end of the test, the total chargeable downtime will be divided by the total number of flights to obtain (\bar{X}) the sample mean CMDT and the sample standard deviation (s) of CMDT.

$$\bar{X} = \frac{\sum_{i=1}^{\text{NOF}} X_i}{\text{NOF}} \quad (\text{Equation B-40})$$

$$s = \sqrt{\frac{\sum_{i=1}^{\text{NOF}} (X_i - \bar{X})^2}{\text{NOF} - 1}} = \sqrt{\frac{1}{(\text{NOF} - 1)} \left[\sum_{i=1}^{\text{NOF}} X_i^2 - (\text{NOF})\bar{X}^2 \right]} \quad (\text{Equation B-41})$$

$$\text{Accept if: } \bar{X} \leq M_0 + \frac{Z_\alpha S}{\sqrt{\text{NOF}}} \quad (\text{Equation B-42})$$

$$\text{Reject if: } \bar{X} > M_0 + \frac{Z_\alpha S}{\sqrt{\text{NOF}}} \quad (\text{Equation B-43})$$

B.4.7 TEST METHOD 6: Test on Manhour Rate.⁵ This test for demonstrating manhour rate (manhours per flight hour) is based on a determination during Phase II (See Appendix E) test operation of the total accumulative chargeable maintenance manhours and the total accumulative demonstration flight hours. The demonstrated manhour rate is calculated as:

$$\text{Manhour Rate} = \frac{\text{Total Chargeable Maintenance Manhours}}{\text{Total Demonstration Flight Hours}} \quad (\text{Equation B-44})$$

If the demonstrated manhour rate is less than or equal to the manhour rate requirement plus a maximum value (ΔMR), by which the demonstrated manhour rate will be permitted to differ from the required manhour rate, then the requirement has been met. ΔMR will be provided, by the procuring activity, as a percentage of the system manhour rate requirement and will be determined based upon such considerations as the expected Phase II duration, and prior experience with similar systems. It is recognized that this demonstration method is non-statistical in nature and does not allow the determination of quantitative producer's and

⁵ Test Method 6 is intended for use with aeronautical systems and subsystems.

APPENDIX B

consumer's risk levels. It is for this reason that the Δ MR is provided (in a subjective manner) to minimize the producer's risk.

Normally, all maintenance performed by approved test maintenance personnel during Phase II and documented in appropriate maintenance reports will be the source of data for identifying chargeable maintenance manhours. The procuring activity may elect to terminate the demonstration prior to Phase II completion if sufficient data are collected to project that the requirement will be met.

The manhour rate requirement must pertain to the aircraft configuration provided for in the contract. For Phase II flights conducted with a configuration other than this, an appropriate amount of chargeable manhours will be included in calculating the total chargeable manhours. This amount will be based upon the predicted manhour rate associated with the equipment not installed.

Care must be exercised in assuring that the predicted manhour rate pertains to flight time and not equipment operating time. Appropriate ratios of equipment operating time to flight time must therefore be developed.

B.4.8 TEST METHOD 7: Test on Manhour Rate - (Using Simulated Faults).⁶ This test for demonstrating manhour rate (manhours per operating hour) is based on (a) the predicted total failure rate of the equipment used in the formulation of Table B-V (see section 3.5.2 of this appendix), and (b) the total accumulative chargeable maintenance manhours and the total accumulative simulated demonstration operating hours. The demonstrated manhour rate is calculated as:

$$\text{Manhour Rate} = \frac{\text{Total Chargeable Maintenance Hours}}{\text{Total Operating Time}} = \frac{\sum_{i=1}^n X_{c_i} + (PS)}{T} \quad (\text{Equation B-45})$$

where:

- X_{c_i} = Manhours for corrective maintenance task i
- n = Number of corrective maintenance tasks sampled; n must not be less than 30
- MTBF = MTBF of the unit (value used in development of Table B-V)
- (PS) = Estimated average total manhours which would be required for preventive maintenance during a period of operating time equal to n-(MTBF) hours

⁶ Test Method 7 is intended for use with ground electronic systems where it may be necessary to simulate faults.

APPENDIX B

$$\frac{\sum_{i=1}^n X_{c_i}}{n} = \bar{X}_c = \text{Average number of corrective maintenance manhours per corrective maintenance task}$$

T = Operating time

Discussion - When maintenance tasks are simulated as in Table B-V, $T = n(\text{MTBF})$, where $1/\text{MTBF} = \lambda_T$, the total failure rate of the equipment in question.

$$\frac{\sum_{i=1}^n X_{c_i} + (\text{PS})}{T} = \frac{\sum_{i=1}^n X_{c_i} + (\text{PS})}{n \bullet (\text{MTBF})} = \frac{1}{\text{MTBF}} \left[\bar{X}_c + \frac{(\text{PS})}{n} \right] \quad (\text{Equation B-46})$$

All components of (B-46) with the exception of \bar{X}_c can be considered constants. \bar{X}_c can be considered a normally distributed variable when n is large (due to the Central Limit Theorem) with Variance = $\frac{d^2}{n}$.

If \bar{X}_c is normally distributed it can be shown that the function: $\frac{1}{\text{MTBF}} \left[\bar{X}_c + \frac{\text{PS}}{n} \right]$ is also normally distributed around the mean of the manpower rate with Variance = $\left(\frac{1}{n} \right) \left(\frac{d}{\text{MTBF}} \right)^2$; assuming $d = \hat{d}$.

Decision Procedure - Therefore, if the manhour rate requirement = μ_R :

Accept if:

$$\bar{X}_c \leq \mu_R (\text{MTBF}) - \left(\frac{\text{PS}}{n} \right) + Z_\alpha \frac{\hat{d}}{n} \quad (\text{Equation B-47})$$

Where α denotes producer's risk.

B.4.9 TEST METHOD 8: Test on a Combined Mean/Percentile Requirement. This test provides for the demonstration of maintainability when the specification is couched in terms of a dual requirement for the mean and either the 90th or 95th percentile of maintenance times when the distribution of maintenance time is lognormal.

ASSUMPTIONS - For use as a dual mean and 90th or 95th percentile requirement, the mean must be greater than 10 and less than 100 units of time; the ratio of the 90th percentile

APPENDIX B

maximum value to the value of the mean must be less than two (2); the ratio of the 95th percentile maximum value to the value of the mean must be less than three.

	Maximum Ratio of Percentile to Mean
90th Percentile Value	2
95th Percentile Value	3

Distribution assumptions are as defined above.

DISCUSSION - The test method actually demonstrates the 61st percentile value of maintenance time in combination with either the 90th or 95th percentile values of maintenance time rather than the mean value of maintenance time in combination with either the 90th or 95th percentile values of maintenance time. However, because of the particular characteristic of the lognormal distribution once a 61st percentile value of maintenance time less than X_1 and a 90th or 95th percentile value less than X_2 has been demonstrated, for all practical purposes, a mean value of less than approximately X_1 and a 90th or 95th percentile value less than X_2 have likewise been demonstrated.

A dual requirement on maintainability, assuming a lognormal distribution of repair times, of a maximum value of the Mean in conjunction with either the maximum value of the 90th or 95th percentile of repair time (to be referred to as M_{Max}) results in the definition of various combinations of θ s and σ s which are acceptable to the dual requirement. (A complete technical description of a lognormal distribution is provided by knowledge of θ and σ , hence all possible lognormal distributions acceptable to the requirements are defined through definition of all possible acceptable values of θ and σ .) See Figure B-8A which defines the acceptable combinations of θ and σ for a Mean of 30 minutes and a 95th percentile (M_{Max}) of 60 minutes.

For the lognormal distribution, it is also possible to structure a dual requirement made up of the maximum values of two percentiles (for example, the 61st percentile of repair time shall be a maximum of 30 minutes and the 95th percentile of repair time shall be a maximum of 60 minutes). This dual requirement also results in the definition of various combinations of acceptable values of θ and σ . See Figure B-8B. If a dual percentile requirement could be structured such that the set of acceptable values of θ and σ defined were almost identical to the set of values of θ and σ defined for a given dual Mean and percentile requirement then a demonstration of that dual percentile requirement would in reality also demonstrate the attainment of the dual Mean and M_{Max} requirement. For this particular instance it has been found that under the assumption listed above, almost identical acceptable values of θ and σ are provided for a combined Mean and M_{Max} requirement and a combined 61st percentile (where the value of the 61st percentile is taken equal to the specified value of the Mean) and M_{Max} requirement. See Figure B-8B which defines the values of θ and σ acceptable to a dual 61st percentile (where the value of the 61st percentile is taken equal to a specified mean of 30 minutes) and 95th percentile (where the

APPENDIX B

maximum value of the 95th percentile, M_{Max} , is given as 60 minutes) and Figure B-8C, which is the superimposition of Figure B-8A on Figure B-8B.

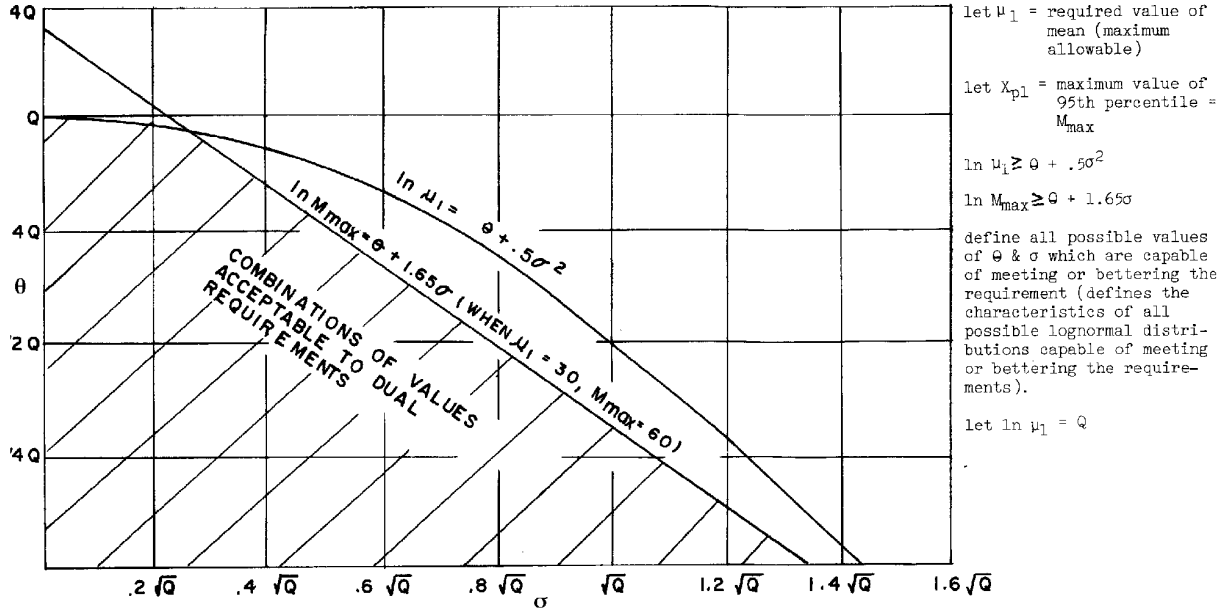

FIGURE B-8A. Acceptable Combinations of Dual Requirements.

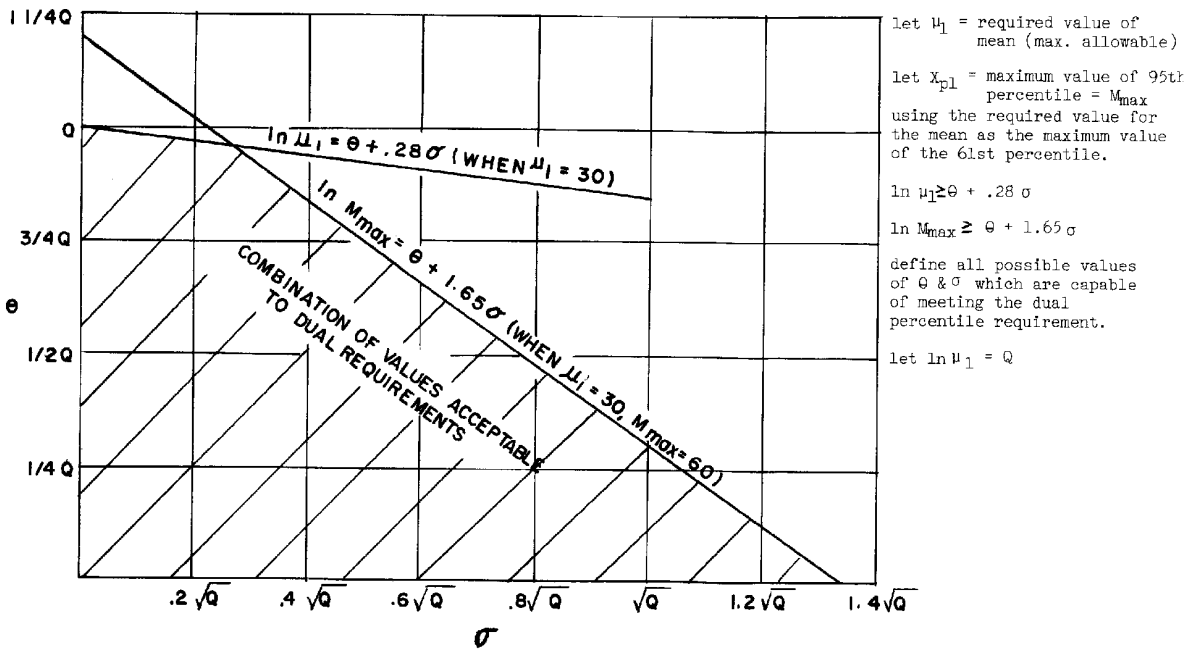

FIGURE B-8B. Values Acceptable to Dual Requirements of Maximum Values of Two Percentiles.

APPENDIX B

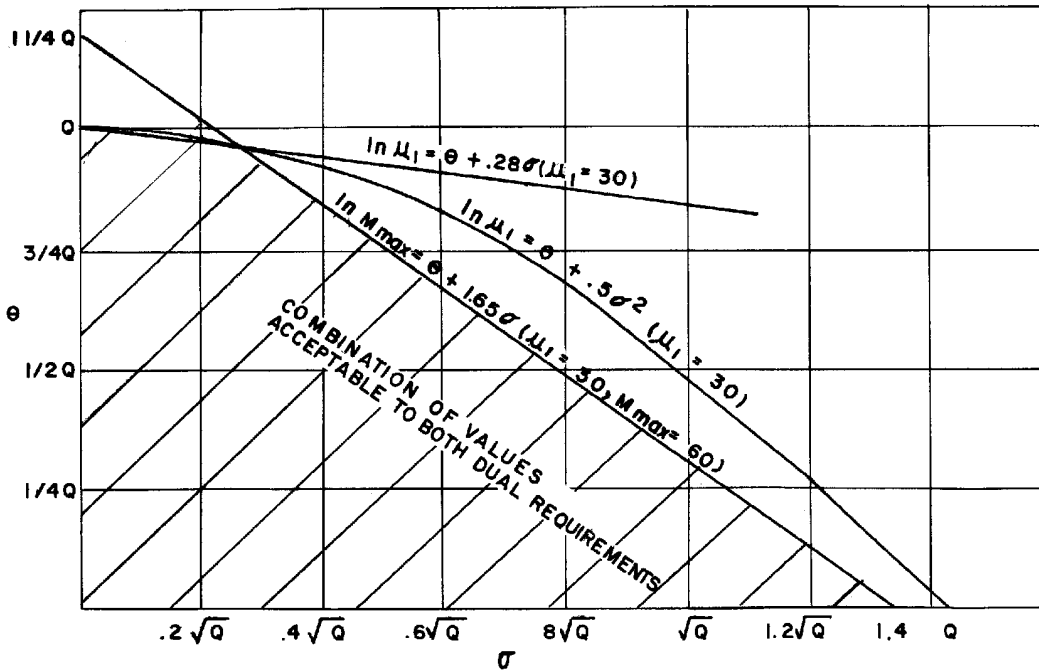

FIGURE B-8C. Superimposition of Figure B-8A and B-8B.

Therefore, tests performed to demonstrate the attainment of both the percentiles in question actually demonstrates the attainment of values of θ and σ which are almost identically acceptable to a dual requirement of the Mean and M_{Max} . It follows then that an accept decision relative to both percentiles would also approximately signify an accept decision for a dual Mean and M_{Max} requirement.

Since both percentiles can be considered independent for practical purposes, the same samples can be used for demonstration of both percentiles, therefore, if desired, the tests may be run simultaneously.

PROCEDURE - Sample tasks are to be selected with respect to the procedure defined for variable sample/sequential tests. The same sample tasks may be used simultaneously in the demonstration of both the Mean and M_{Max} requirements. Table B-X*, Table B-XI*, and Table B-XII* (which are based upon the sequential probability ratio test of proportion) define the accept/reject criteria for the values of the required mean, M_{Max} (when defined as the maximum 90th percentile value), M_{Max} (when defined as the maximum 95th percentile value), respectively. The number of observations greater than and less than the required values of the Mean and M_{Max} must be cumulated separately and compared to the decision values shown in the tables applicable to the two requirements. When one plan provides an accept decision, attention to that plan is discontinued. The second plan continues until a decision is reached. The

* Tables B-X, B-XI, and B-XII are appropriate to Test Plans A₁, B₁ and B₂, respectively.

APPENDIX B

**TABLE B-X. PLAN A₁: OBSERVATIONS EXCEEDING THE VALUE OF THE MEAN
(OR 61ST PERCENTILE VALUE).**

# of Tasks Observed (N)	Accept	Reject	# of Tasks Observed (N)	Accept	Reject
5		5	55	12	20
6		6	56	13	↓
7		↓	57	↓	21
8		↓	58	↓	↓
9		7	59	14	↓
10		↓	60	↓	22
11		↓	61	↓	↓
12	0	↓	62	↓	↓
13	↓	8	63	15	23
14	↓	↓	64	↓	↓
15	1	↓	65	↓	↓
16	↓	9	66	16	↓
17	↓	↓	67	↓	24
18	↓	↓	68	↓	↓
19	2	↓	69	17	↓
20	↓	10	70	↓	25
21	↓	↓	71	↓	↓
22	3	↓	72	↓	↓
23	↓	11	73	18	↓
24	↓	↓	74	↓	26
25	4	↓	75	↓	↓
26	↓	12	76	19	↓
27	↓	↓	77	↓	27
28	↓	↓	78	↓	↓
29	5	↓	79	20	↓
30	↓	13	80	↓	28
31	↓	↓	81	↓	↓
32	6	↓	82	↓	↓
33	↓	14	83	21	↓
34	↓	↓	84	↓	29
35	7	↓	85	↓	↓
36	↓	15	86	22	↓
37	↓	↓	87	↓	30
38	↓	↓	88	↓	↓
39	8	↓	89	↓	↓
40	↓	16	90	23	31
41	↓	↓	91	↓	↓
42	9	↓	92	↓	↓
43	↓	17	93	24	↓
44	↓	↓	94	↓	32
45	↓	↓	95	↓	↓
46	10	↓	96	25	↓
47	↓	18	97	↓	33
48	↓	↓	98	↓	↓
49	11	↓	99	↓	↓
50	↓	19	100	26	↓
51	↓	↓			
52	12	↓			
53	↓	20			
54	↓	↓			

APPENDIX B

TABLE B-XI. PLAN (B₁): OBSERVATIONS EXCEEDING M_{max} - 90 Percentile

# of Tasks Observed (N)	Accept	Reject	# of Tasks Observed (N)	Accept	Reject
2		2	52	1	4
3			53		5
4			54		
5			55		
6			56		
7			57		
8			58		
9			59		
10			60		
11			61		
12			62		
13		↓	63		
14		3	64	↓	
15			65	2	
16			66		
17			67		
18			68		
19			69		
20			70		
21			71		
22			72		
23			73		6
24			74		
25			75		
26	0		76		
27			77		
28			78		
29			79		
30			80		
31			81		
32			82		
33		↓	83		
34		4	84	↓	
35			85	3	
36			86		
37			87		
38			88		
39			89		
40			90		
41			91		
42			92		↓
43			93		7
44			94		
45	↓		95		
46	1		96		
47			97		
48			98		
49			99		
50		↓	100	↓	↓
51	↓	↓			

APPENDIX B

TABLE B-XII. PLAN (B₂): OBSERVATIONS EXCEEDING M_{max} - 95 Percentile

# of Tasks Observed (N)	Accept	Reject	# of Tasks Observed (N)	Accept	Reject
2		2	52		3
3			53		
4			54		
5			55		
6			56		
7			57	0	
8			58		
9			59		
10			60		
11			61		
12			62		
13			63		
14			64		
15			65		
16			66		
17			67		
18			68		▼
19			69		3
20			70		4
21			71		
22			72		
23			73		
24			74		
25			75		
26		▼	76		
27		2	77		
28		3	78		
29			79		
30			80		
31			81		
32			82		
33			83		
34			84		
35			85		
36			86		
37			87		
38			88		
39			89		
40			90		
41			91		
42			92		
43			93		
44			94		
45			95		
46			96		
47			97	▼	
48			98	0	
49			99	1	▼
50			100	1	4
51		▼			

APPENDIX B

equipment is rejected when a decision to reject on either plan has occurred regardless of the status of the other plan. The equipment is accepted only when an accept decision has been reached on both plans. If no accept or reject decision has been made after 100 observations, the following rule applies:

Plan A_1 - Accept only if 29 or less observations are more than the value of the required Mean.

Plan B_1 - Accept only if 5 or less observations are more than M_{Max_c} .

Plan B_2 - Accept only if 2 or less observations are more than M_{Max_c} .

It is recognized and accepted that truncation will somewhat modify probability of acceptance characteristics as described in the following subsection.

The OC Curve - The operating characteristic curve for the test procedure may be determined by mapping the probability of acceptance for various selected points on a diagram of the acceptable and unacceptable regions such as Figure B-8D. (Note that any point can be identified uniquely by the coefficient of Q , where $Q = \ln(\text{required Mean})$, on the ordinate and the coefficient of \sqrt{Q} on the abscissa - let the coefficient of Q be denoted as (C) and the coefficient of \sqrt{Q} be denoted as (K) - for example, point B on Figure B-8D can be uniquely located at $C=3/4$, $K=.4$). Each point is also representative of a particular lognormal distribution possessing unique percentiles for the values given for μ_1 (required maximum value for Mean) and M_{Max} , respectively.

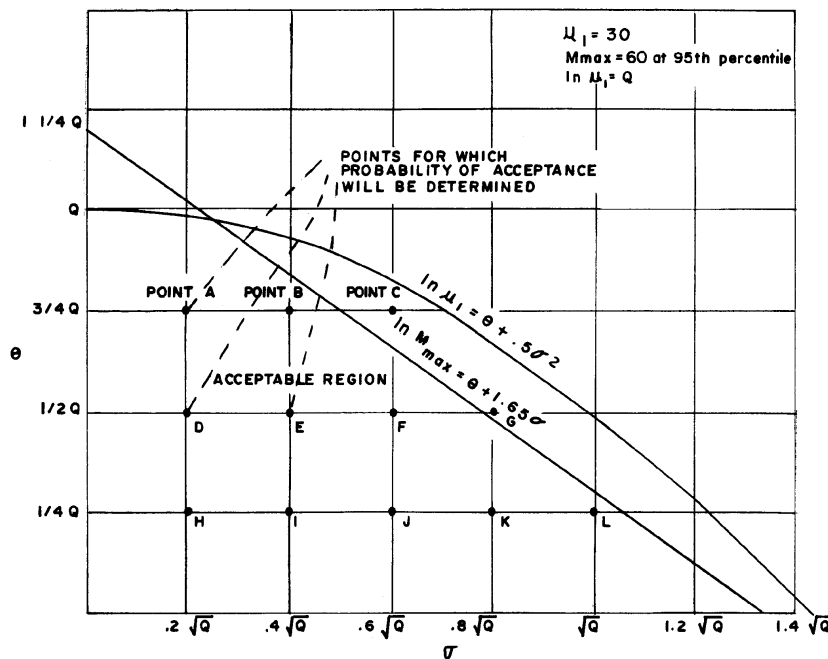

FIGURE B-8D. OC Curve for Test Method 8.

APPENDIX B

The probability of acceptance relative to any point is equal to the compound probability of passing the percentile test relative to μ_1 (Test A_1) and passing the percentile test relative to M_{Max} (Test B_1 or B_2).

Let P_{A1} , P_{B1} , and P_{B2} be the probability of passing test A_1 , B_1 and B_2 , respectively for any given unique combination of θ and σ (a particular point). P_{A1} , P_{B1} , and P_{B2} may be determined by calculating Y_{A1} , Y_{B1} , and Y_{B2} from the following equations:

$$Y_{A1} = \frac{\sqrt{Q}(1-C)}{K} \quad (\text{Equation B-48})$$

$$Y_{B1} = Y_{B2} = \frac{\ln M_{\text{max}} - CQ}{K\sqrt{Q}} \quad (\text{Equation B-49})$$

and entering Figure B-8E (for Test A_1) with the calculated value of Y_{A1} and Figure B-8F (for Test B_1) or Figure B-8G (for Test B_2) with the calculated value of Y_{B1} or Y_{B2} . The corresponding value of probability of acceptance, P_{A1} , and P_{B1} or P_{B2} (whichever of the B tests are appropriate) is read from each figure and P_{A1} and the appropriate P_{B1} , or P_{B2} value are multiplied. The result of this multiplication is the probability of acceptance of a unit having a particular θ and σ characteristic defined by (C) and (K).

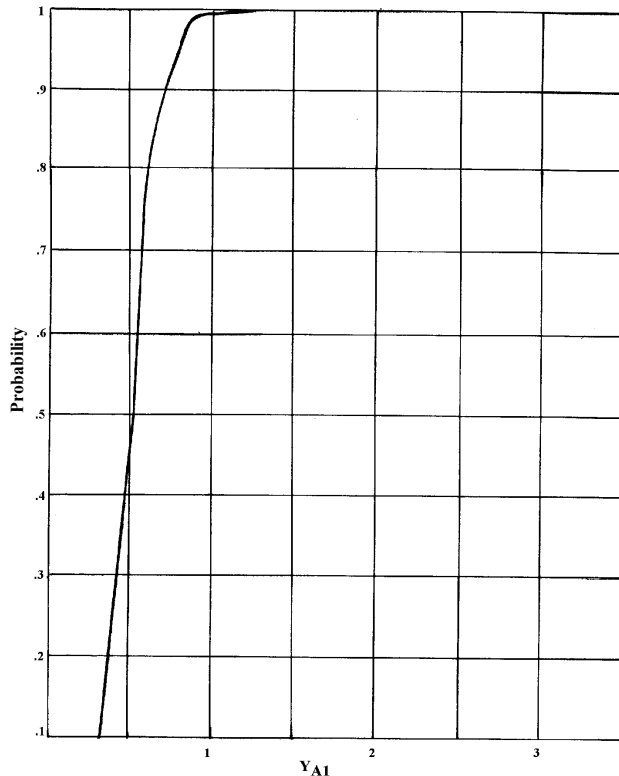

FIGURE B-8E. Probability of Passing Test A.

APPENDIX B

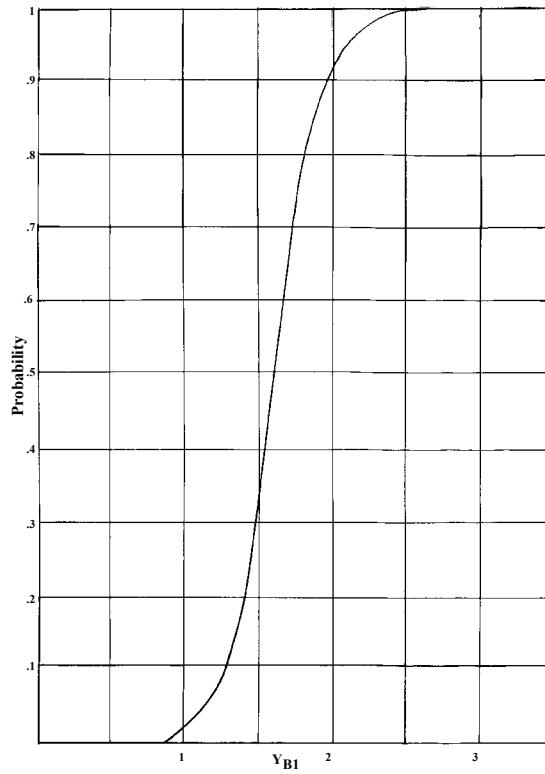

FIGURE B-8F. Probability of Passing Test B₁.

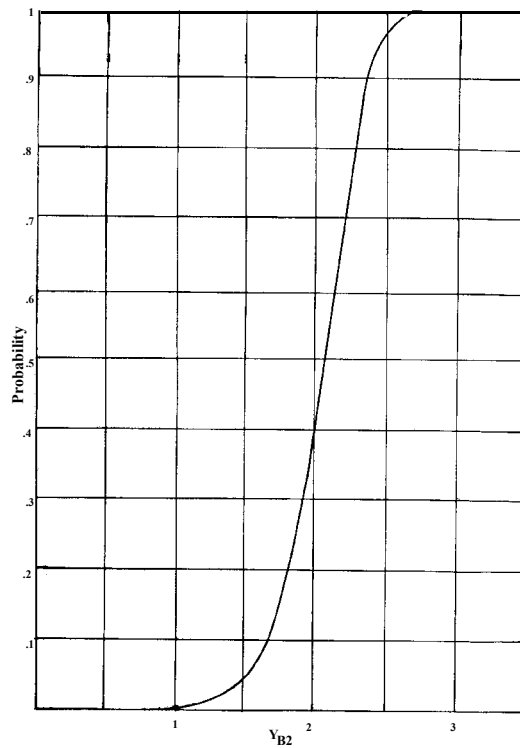

FIGURE B-8G. Probability of Passing Test B₂.

APPENDIX B

Repeating the above for a number of points, as in Figure B-9, defines an operating characteristic map relative to a given dual requirement. Note that probabilities of acceptance always decrease as the point is located upward or to the right and always increase as the point in consideration is located downward or to the left on the figure. Hence, sufficient knowledge of test characteristics can be generated by evaluating relatively few points.

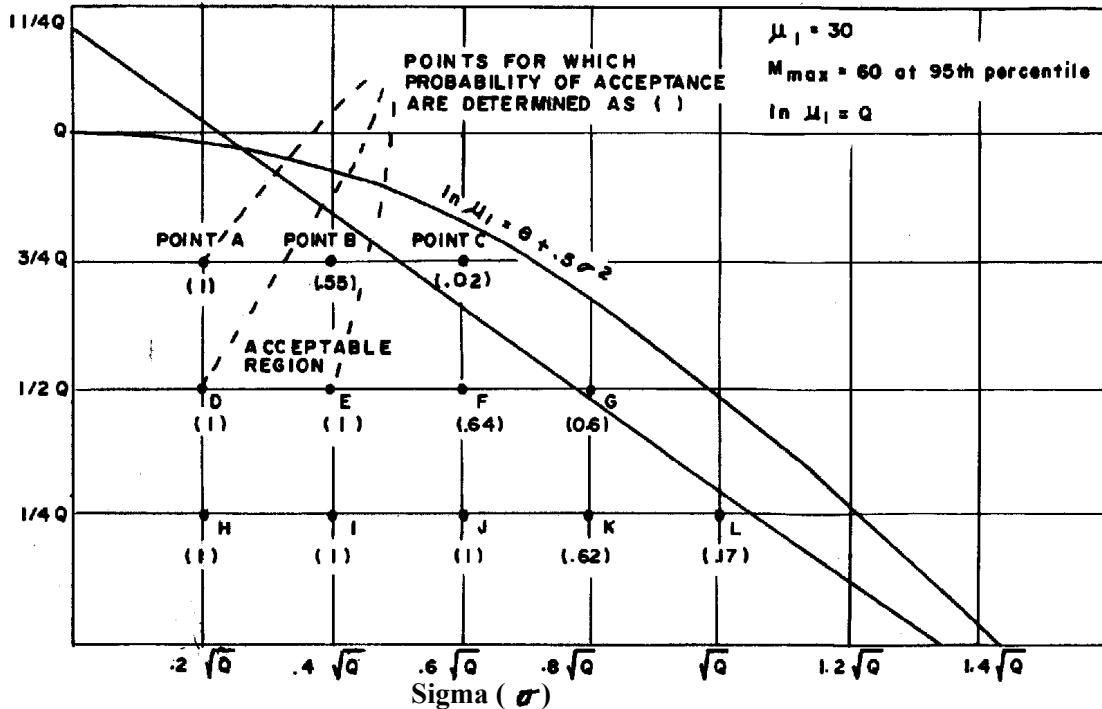

FIGURE B-9. OC Map Relative to a Given Dual Requirement.

B.4.10 TEST METHOD 9: Test for Mean Maintenance Time (Corrective, Preventive, Combination of Corrective and Preventive) and M_{Max} . This method is applicable to demonstration of the following indices of maintainability: Mean Corrective Maintenance Time (μ_c), Mean Preventive Maintenance Time (μ_{pm}), Mean Maintenance Time (includes preventive and corrective maintenance actions) ($\mu_{p/c}$), and M_{Max} (percentile of repair time).

CONDITIONS OF USE - The procedures of this method for demonstration of μ_c , are based on the Central Limit Theorem. No information relative to the variance (d^2) of maintenance times is required. It may therefore be applied whatever the form of the underlying distribution, provided the sample size is adequate. The minimum sample size is set at 30. The actual sample size (if greater than 30 are required) must be determined for each equipment to be demonstrated, and is usually approved by the procuring activity.

Note: The procedure of this method for demonstrating M_{Max_c} is valid for those cases where the underlying distribution of corrective maintenance task times is lognormal.

APPENDIX B

QUANTITATIVE REQUIREMENTS - Application of this plan requires identification of the index or indices of interest and specification of quantitative requirements for each. When demonstration involves μ_c or μ_{pm} , or a combination of both, consumer's risks need to be specified. When demonstration involves M_{Max_c} , the percentile point which defines the specified value of M_{Max_c} is specified. A minimum sample size of 30 corrective maintenance tasks is required for demonstration of corrective maintenance indices. A minimum sample of 30 preventive maintenance tasks is required where demonstration of preventive maintenance indices by sampling is permitted and is to be accomplished by this method.

TASK SELECTION AND PERFORMANCE - Sample tasks are selected in accordance with the stratification procedures outlined in Section 3.5.2. The duration of each is recorded and used to compute the following statistics:

$$\bar{X}_c = \frac{\sum_{i=1}^{n_c} X_{c_i}}{n_c}$$

$$\bar{X}_{pm} = \frac{\sum_{i=1}^{n_{pm}} X_{pm_i}}{n_{pm}}$$

$$D_t = f_c \bar{X}_c + f_{pm} \bar{X}_{pm}$$

$$\bar{X}_{p/c} = \frac{f_c X_c + f_{pm} X_{pm}}{f_c + f_{pm}}$$

$$M'_{max_c} = \text{Anti log} \left[\frac{\sum_{i=1}^{n_c} \ln X_{c_i}}{n_c} + \Psi \sqrt{\frac{\sum_{i=1}^{n_c} (\ln X_{c_i})^2 - \frac{\left(\sum_{i=1}^{n_c} \ln X_{c_i} \right)^2}{n_c}}{n_c - 1}} \right]$$

APPENDIX B

where the Antilog is taken to the Base e and where ψ is the value of the independent variable lognormal function which corresponds to the percentile point at which M_{Max_c} has been established. For the two most common percentile points, 90% and 95%, ψ is 1.282 and 1.645 respectively.

ACCEPT/REJECT CRITERIA - A table of the normal distribution function is consulted for values of ϕ (for a one-tailed test) which corresponds to the specified level of consumer risk β . Table XIII provides values of ϕ which correspond to the most commonly used values of β .

TABLE B-XIII. ϕ vs. β .

ϕ	β
0.84	20%
1.04	15%
1.28	10%
1.65	5%

Accept/reject criteria is computed for each specified index in accordance with the following:

Test for Mean Corrective Maintenance Time (μ_c) - The accept/reject value for μ_c is:

$$\bar{X}_c + \frac{\phi \hat{d}_c}{\sqrt{n_c}} \quad \hat{d}_c = \text{standard deviation of sample of corrective maintenance tasks.}$$

$$\text{Accept if } \mu_c \text{ (specified)} \geq \bar{X}_c + \frac{\phi \hat{d}_c}{\sqrt{n_c}}$$

$$\text{Reject if } \mu_c \text{ (specified)} < \bar{X}_c + \frac{\phi \hat{d}_c}{\sqrt{n_c}}$$

Test for Mean Preventive Maintenance Time (μ_{pm}) - The accept/reject value for μ_{pm} is:

$$\bar{X}_{pm} + \frac{\phi \hat{d}_{pm}}{\sqrt{n_{pm}}} \quad \hat{d}_{pm} = \text{standard deviation of sample of preventive maintenance tasks.}$$

$$\text{Accept if } \mu_{pm} \text{ (specified)} \geq \bar{X}_{pm} + \frac{\phi \hat{d}_{pm}}{\sqrt{n_{pm}}}$$

APPENDIX B

$$\text{Reject if } \mu_{pm} \text{ (specified)} < \bar{X}_{pm} + \frac{\phi \hat{d}_{pm}}{\sqrt{n_{pm}}}$$

Test for the Mean of all Maintenance Actions ($\mu_{p/c}$) - The accept/reject value of $\mu_{p/c}$ is:

$$\bar{X}_{p/c} + \phi \sqrt{\frac{n_{pm} (f_c \hat{d}_c)^2 + n_c (f_{pm} \hat{d}_{pm})^2}{n_c n_{pm} (f_c + f_{pm})^2}}$$

$$\text{If } \mu_{p/c} \text{ (specified)} \geq \bar{X}_{p/c} + \phi \sqrt{\frac{n_{pm} (f_c \hat{d}_c)^2 + n_c (f_{pm} \hat{d}_{pm})^2}{n_c n_{pm} (f_c + f_{pm})^2}}, \text{ Accept}$$

$$\text{If } \mu_{p/c} \text{ (specified)} < \bar{X}_{p/c} + \phi \sqrt{\frac{n_{pm} (f_c \hat{d}_c)^2 + n_c (f_{pm} \hat{d}_{pm})^2}{n_c n_{pm} (f_c + f_{pm})^2}}, \text{ Reject}$$

Test for M_{Max_c} - The accept/reject value for M_{Max_c} is:

$$M'_{Max_c} = \text{Antilog} \left[\frac{\sum_{i=1}^{n_c} (\ln X_{c_i})}{n_c} + \Psi \sqrt{\frac{\sum_{i=1}^{n_c} (\ln X_{c_i})^2 - \frac{(\sum_{i=1}^{n_c} \ln X_{c_i})^2}{n_c}}{n_c - 1}} \right], \text{ where Antilog is to the}$$

Base e.

Accept if $M_{Max_c} \text{ (specified)} \geq M'_{Max_c}$

Reject if $M_{Max_c} \text{ (specified)} < M'_{Max_c}$

B.4.11 TEST METHOD 10: Tests for Percentiles and Maintenance Time (Corrective Preventive Maintenance). This method employs a test of proportion to demonstrate

APPENDIX B

achievement of \tilde{M}_{ct} , \tilde{M}_{pm} , M_{Max_c} and $M_{Max_{pm}}$ when the distribution of corrective and preventive maintenance repair times is unknown.

CONDITIONS OF USE - This method is intended for use in cases where no information is available on the underlying distribution of maintenance task times. The plan holds the confidence level at 75% or 90% as may be desired and requires a minimum sample size (N) of 50 tasks.

QUANTITATIVE REQUIREMENTS - Application of this method requires specification of \tilde{M}_{ct} , \tilde{M}_{pm} , $M_{Max_{ct}}$ (95th percentile) or $M_{Max_{pt}}$ (95th percentile) and selection of 75% or 90% confidence level.

TASK SELECTION AND PERFORMANCE - Sample tasks are selected in accordance with the stratification procedures outlined in section 3.5.2. The duration of each task will be compared to the required value(s) of the specified index or indices (\tilde{M}_{ct} , \tilde{M}_{pm} , $M_{Max_{ct}}$ and $M_{Max_{pm}}$) and recorded as greater than or less than each index.

ACCEPT/REJECT CRITERIA - The item under test shall be accepted when the number of observed task times which exceed the required value of each specified index is less than or equal to that shown in the Table (B-XIV or B-XV) corresponding to each index for the specified confidence level.

Test for the Median - Table B-XIV is a test of the median for corrective and preventive maintenance tasks. The acceptance level is shown for two confidence levels and a sample size (N) of 50 tasks.

TABLE B-XIV⁷. Acceptance Table for \tilde{M}_{ct} , or \tilde{M}_{pm} ; Sample Size = 50.

<u>Confidence Level</u>	
75%	90%
<u>Acceptance Level</u>	
22	20

Test for M_{Max_c} and $M_{Max_{pm}}$ - Table B-XV is a test for M_{Max_c} and $M_{Max_{pm}}$ at the 95th percentile. The acceptance level is shown for two confidence levels and a sample size (N) of 50 tasks.

⁷ NOTE: Reference for Tables B-XIV and B-XV - "Introduction to Statistical Analysis" by Dixon & Massey, Page 230, McGraw-Hill Company, 2nd Edition, 1957.

APPENDIX B

TABLE B-XV. Acceptance Table for M_{Max_c} or $M_{Max_{pm}}$; Sample Size = 50.

<u>Confidence Level</u>	
75%	90%
<u>Acceptance Level</u>	
1	0

B.4.12 TEST METHOD 11: Test For Preventive Maintenance Times. This method provides for maintainability demonstration when the specified index involves μ_{pm} and/or $M_{Max_{pm}}$ and when all possible preventive maintenance tasks are to be performed.

CONDITIONS OF USE - All possible tasks are to be performed and no allowance need be made for underlying distribution.

QUANTITATIVE REQUIREMENTS - Application of this plan requires quantitative specification of the index or indices of interest. In addition, the percentile point defining $M_{Max_{pm}}$ must be stipulated when $M_{Max_{pm}}$ is of interest.

TASK SELECTION AND PERFORMANCE - All preventive maintenance tasks will be performed. The total population of PM tasks will be defined by properly weighing each task in accordance with relative frequency of occurrence as follows: Select the particular task for which the equipment operating time to task performance is greatest and establish that time as the reference period. Determine the frequency of occurrence (f_{pm}) of all other tasks during the reference period, where the frequency of occurrence of a given task is a fractional number, the frequency shall be set at the nearest integer. The total population of tasks consists of all tasks with each repeated in accordance with its frequency of occurrence during the reference period.

ACCEPT/REJECT CRITERIA

Test for μ_{pm} - the mean is computed as follows:

$$\mu_{pm} \text{ (Actual)} = \frac{\sum_{i=1}^k f_{pm_i} (X_{pm_i})}{\sum_{i=1}^k f_{pm_i}}$$

Where: f_{pm_i} is the frequency of occurrence of the i^{th} task in the reference period,

k is the number of different PM tasks.

APPENDIX B

$\sum f_{pm_i}$ is the total number of PM tasks in the population.

Accept if: μ_{pm} (required) \geq μ_{pm} (actual)

Reject if: μ_{pm} (required) $<$ μ_{pm} (actual)

Test for $M_{Max_{pm}}$ - The PM tasks shall be ranked by magnitude (lowest to highest value).

The equipment shall be accepted if the magnitude of the task time at the percentile of interest is equal to or less than the required value of $M_{Max_{pm}}$.

B.5.0 Maintainability Evaluation

The objective of maintainability evaluation is to evaluate the impact of the actual operational, maintenance, and support environment on the maintainability parameters of the system, to evaluate the correction of any deficiencies exhibited during maintainability demonstration, and to demonstrate depot level maintenance tasks when applicable. A maintainability evaluation is managed and conducted by the procuring activity during Operational Test and Evaluation as part of the total system evaluation (see Figure B-1). Many of the requirements for demonstration testing apply for evaluation testing except for the following:

- All evaluation items are production or production equivalent models
- The evaluation is conducted in the actual operational and maintenance environment unless otherwise specified by the procuring activity
- All maintenance tasks are performed by those personnel (either procuring agency (e.g., government or civil service) or contractor who would normally perform maintenance on the system in the fielded environment at the specified maintenance level.
- Maintenance tasks to be evaluated are those resulting directly from and incidental to actual operation and maintenance. These tasks should be supplemented by fault simulation only to evaluate specific tasks or special tasks that do not occur by chance during the evaluation phase.

B.6.0 Maintainability Verification/Demonstration/Evaluation Planning and Management

Management of maintainability verification/demonstration/evaluation should include the development of a maintainability test program plan⁸. The plan is prepared by the system developer and should typically include the following sections, tailored according to the specific

⁸ This plan should be an integral part of the overall test plan for the development program.

APPENDIX B

requirements of a program. Each of the sections should be in some way identified as being applicable to verification, demonstration or evaluation phases of the program.

Background Information - Includes a description of the quantitative and qualitative maintainability requirements; the maintenance concept; maintenance environment; applicable levels of maintenance; where testing is to be conducted; test facilities requirements; participating agencies; mode (s) of operation of the items of interest, including configuration and mission requirements; the specific items that are subject to verification, demonstration, and evaluation; and data required for completion of the verification/demonstration/evaluation.

Item Interface - A description of the adequacy or inadequacy of the item support elements and an estimate of their effect on the item maintainability. These elements would include the following: Maintenance planning; support and test equipment; supply support; transportation, handling and storage; technical data; facilities; and personnel and training.

Test Team - A test team should be assembled and described in the plan. The description should include: Organization, degree of participation of procuring activity personnel and system developer personnel, including managerial, technical, maintenance, and operation personnel. The plan should also include test team member qualifications, quantity, sources, training requirements, and indoctrination requirements.

Support Material - This section should cover support equipment, tools and test equipment, technical manuals to be used (or required), spares and consumables requirements/needs, safety equipment needs, and calibration equipment requirements.

Preparation Plan - Include a description of and schedule for the organization and assembly of the test team, training of personnel, preparation of facilities, and availability, assembly, checkout, and preliminary validation of support material.

Implementation - Provide a description of: the test objectives of each test phase (i.e., verification, demonstration, evaluation), schedule of tests (as coordinated with other disciplines); procedures for selection of maintenance tasks when faults are to be simulated; any special maintenance tasks, such as those requiring unique skills, equipment, test methods, etc., to be performed, including method of demonstration; test method (see Section 3.6), including accept/reject decision criteria, risks, etc.; data acquisition methods; data analysis methods and procedures; specific data elements; type and schedule of reports to be generated, if any; and the maintenance tasks to be verified, demonstrated, and evaluated.

Retesting Requirements - Provide a provisional schedule for special or repeat testing required to investigate any deficiencies or trouble areas. Deficiencies should be corrected in any item which has failed to meet the acceptance criteria. The corrected portions of the item and any

APPENDIX B

other portions of the item affected by the correction should be retested during retest. The maintenance tasks to be demonstrated should be as designated by the procuring activity.

B.6.1 Test Procedures. In designing the maintainability test procedures, both qualitative and quantitative requirements should be verified, demonstrated and evaluated. Typically, qualitative maintainability requirements to be verified, demonstrated and evaluated are described via a checklist prepared by the system developer and coordinated with the procuring activity, when applicable. These checklists permit observation, analysis, and identification of maintainability characteristics incorporated or omitted. Quantitative requirements are verified, demonstrated, and evaluated by actual demonstration of maintenance tasks.

B.6.1.1 Maintenance Task Generation. As implied, verification, demonstration and evaluation is accomplished by performance of maintenance tasks at a specified maintenance level. Generation of the specific maintenance tasks during each maintainability test phase can take several forms as indicated below. The means by which the tasks are generated should be considered, planned for and documented in the maintainability test plan.

Actual operation of the item in the specified test, operational and maintenance environment is always the preferred method of maintenance tasks generation (i.e., maintenance is performed as a result of naturally occurring failures). This can only be done, however, provided that assurances can be given that a sufficient number of failures or maintenance tasks will occur during the test period to satisfy any minimum sample requirements for the test method employed. This method of maintenance task generation must therefore be considered early in the development stages to make sure that a sufficient number of test or operational hours are planned, both through tests dedicated for maintainability and other forms of testing, to make this approach feasible. Close coordination with the entire development team is required for this approach to maximize all test time planned.

In lieu of the naturally occurring failure approach to maintenance task generation is the fault or failure simulation approach. This approach is to introduce failures by way of faulty parts, deliberate misalignment, open leads, shorted parts, etc. As part of this approach, a maintenance task sampling plan, as described in Section 3.5.2, must be prepared. When this is done as part of demonstration testing, the actual task selection should not be made by the test team until immediately prior to the demonstration.

B.6.2 Administration. As mentioned in the description of the maintainability test plan, a test team consisting of members of both the procuring activity, if any, and the system developer should be formed to manage the test program. The team members should be empowered to make decisions for their respective organizations. Each member of the team may have advisors from their organizations who are knowledgeable in the various aspects of the demonstration and the requirements of the verification/demonstration/evaluation plan. The responsibilities of the team

APPENDIX B

will be in accordance with what is described in the maintainability test plan, and should typically include the following:

- Maintain surveillance over maintenance and inspection operations. Any apparent discrepancies in maintenance task accomplishment and documentation observed by any member of the team should be brought to the attention of the remaining test team members within one working day of the occurrence for appropriate action.
- Evaluate and validate maintenance and operational data to determine applicable labor hours, flying hours, operating time, maintenance time, downtime, item status, etc.
- Assure that the demonstration item selected has been adequately prepared in accordance with applicable technical manuals and that no maintenance has been deferred that will compromise the successful completion of the next scheduled operation or mission prior to being placed in an operational ready status.
- Decide if resulting failures, maintenance time, elapsed downtime, maintenance labor hours, etc., should be chargeable in cases where operator or maintenance crew errors have been committed.
- Rule on questions of whether or not the verification, demonstration, and evaluation plan has been adhered to.
- Rule on controversial points which may arise that are not specifically covered by applicable specifications or other pertinent documentation. Further, determine those matters which require contractual interpretation or resolution by the appropriate procuring authority and system developer organizations. For these matters, the test team majority and minority statements should be submitted to the procuring activity, or other applicable authorities' contracting officer for resolution.
- Prepare and submit demonstration status reports to the procuring activity and system developer.
- Analyze data and determine the extent of achievement of specified maintainability requirements.
- Prepare and submit final results of each of the maintainability test phases to the procuring activity and the system developer within the time period indicated in the test plan.
- Assure that the following conditions have been fulfilled prior to the start of the demonstration and evaluation test phase:
 - each test item complies with the established configuration or that all deviations reported have been accepted by the procuring activity
 - all required technical manuals have been updated as necessary.
 - all support resources are available in the type and quantity specified in the verification, demonstration and evaluation test plan.
 - all operator or maintenance crew personnel are properly trained and meet established skill level requirements.

APPENDIX B

- all records of approved changes in personnel requirements, operating and maintenance manuals, data handling procedures and analysis techniques have been incorporated in the final revision of the verification, demonstration, and evaluation test plan.

B.6.2.1 Other Administrative Requirements. In addition to those duties just listed for the test team, there are other administrative duties that usually accompany the implementation of a maintainability test plan. For instance, the designated test team should have a test director who has the authority to decide in all cases of deadlock between the members of the team. This person is usually designated by the procuring activity. Other such requirements or "rules of conduct" are provided below.

Instrumentation Failures: Any failures of test instrumentation used to instrument the demonstration item for test purposes or failures induced by such test instrumentation installation or operation, and all associated maintenance are not chargeable maintenance tasks.

Maintenance Due To Secondary Failures: If any secondary failures result from a chargeable primary failure, the total resultant maintenance time to restore the items are chargeable as a single maintenance task, except when the secondary failure results from the method used to simulate a fault rather than from the fault itself. If the reason for the secondary failure is removed (corrected), the time charged for the secondary failure can be deleted.

Inadequate Technical Manuals Or Support Equipment: If, in the accomplishment of a maintenance task, a technician finds the applicable technical manuals or support equipment to be inadequate, these instances should be brought to the attention of the test team and, if the inadequacy is verified, this portion of the demonstration can be terminated. In these instances, times measured are not chargeable. Action then must be taken to correct the inadequacies of the technical manuals or support equipment, after which the same maintenance task is repeated.

Cautions: If an item is damaged or maintenance errors induced by item design complexity, by poor design practice, or by following improper procedures that allow improper maintenance (e.g., interchangeability of connectors) without proper caution in the technical manuals, the failure and resultant maintenance times are chargeable. In these cases, action is then taken to correct the improper procedures or deficiencies and the corrective action verified. When this action is completed, the maintenance time saved can then be deleted.

Personnel Number and Skill: Each task should be performed by the prescribed number of personnel with the prescribed skills. If personnel are required on an intermittent or sequenced basis, the labor hours assessed against the maintenance task will include the required standby time only if the standby time is of a type or duration which prevents standby personnel from performing other productive tasks.

APPENDIX B

Cannibalization: The maintenance associated with the removal or reinstallation of the item or support equipment assemblies and/or components for cannibalization purposes are not chargeable unless the deficiency can be directly related to lack of recommendations for proper level of support spares or expendables. If the system developer takes action to correct the deficiency, the time charged can be deleted.

B.6.3 Data Collection. As mentioned in other parts of this handbook, data collection is important to the ability to identify weaknesses in the maintainability design of a system and subsequent correction of those weaknesses. For the purposes of verification, demonstration and evaluation, a sound data collection system must exist and be coordinated with other disciplines and tests. The data system should be accessible by all members of the test team, including the procuring activity, and should include information on all mission debriefings, failures and maintenance data. The descriptions of all maintenance tasks must be adequate to enable determination of which maintenance task was performed. It is important to include in the maintainability database or maintenance related data records, all direct maintenance downtime or labor hours which are not specifically determined to be nonchargeable. This information will then feed into the quantitative calculations of all applicable maintainability metrics. Maintenance times that may not be chargeable could result from such causes as:

- Maintenance and operational errors not chargeable to technical manuals, system developer furnished training or faulty design
- Miscellaneous tasks such as keeping of records, taxiing and towing of aircraft to or from an area other than the assigned work center area
- Repair of accident damage
- Documented delay downtime (supply or administrative) which is clearly outside the responsibility of the system developer
- Modification tasks
- Maintenance of test instrumentation exclusive of normal configuration
- Maintenance time accountable to test instrumentation installation (other than normal configuration) accrued during maintenance task performance

In any case, it is extremely important to establish up front in the program which maintenance tasks will be chargeable, and which ones that will not. This will avoid confusion and arguments later on between test team members.

B.6.3.1 Maintainability Parameter Calculations. All data acceptable to the test team during each applicable test phase (i.e., verification, demonstration, etc.) is used in calculating the maintainability parameters of interest. Section B.4.0 of this appendix provides methods of calculating several such parameters and for determining, statistically, whether the system meets the requirements.

APPENDIX B

B.6.4 Documentation. After each phase of maintainability testing, a final report should be developed that documents, as a minimum, the following information:

- Summary of data collected and location of data files
- Factors that influence the data
- Analysis of the data
- Results of the phase and certification that the specified objectives and requirements have or have not been met
- Assessment of the integrated logistic support factors, such as technical manuals, personnel, tools and test equipments, support equipment, maintenance concept and provisioning for their effect on quantitative and qualitative demonstrated maintainability parameters
- All noted deficiencies
- All recommendations to correct deficiencies and to make improvements

B.7.0 Testability Demonstration

A review made of a sample of past maintainability demonstrations showed a 100% success rate for both large and small systems at primarily the organizational and intermediate maintenance level. Only a small percentage of the systems reviewed, however, specifically addressed testability. Those that did also had a 100% demonstration success rate, determined by specifically calculating the percentage of faults detected and isolated. Despite the fact that maintainability demonstrations are quite successful, testability related problems, especially those associated with Built-In-Test (BIT), have continued to plague the maintainability performance of many complex systems. Metrics such as cannot duplicate (CND) rate, retest OK (RTOK), and false alarm rate have continued at unacceptable values in actual operations resulting in too many resources being spent on maintenance of systems and equipments.

There are several reasons why maintainability demonstrations are usually successful, but testability performance in the field continues to fall short of both expectations and demonstrated values. Specifically, current demonstration techniques are inadequate to demonstrate testability metrics such as fraction of faults detected and fault isolation resolution. Most maintainability demonstrations are performed in laboratory environments using the fault insertion methods previously described. Furthermore, the faults selected for insertion represent a small percentage of those likely to occur during fielded operation. The reasons for limiting the number of faults inserted include the fact that faults that will result in equipment damage or cannot be easily inserted are not selected for demonstration. Only hard faults, such as open leads or shorted components, that are relatively easy to detect, isolate and repair are selected. Also, many of the faults that result in CNDs or RTOKs, are not easily simulated in a demonstration test. Finally, it is not possible to simulate failures or intermittent conditions that can be considered false alarms, thus eliminating the ability to demonstrate any specified false alarm rate for BIT.

APPENDIX B

Given the preceding facts, effective demonstration of testability is probably not possible in the near future. It should be considered as part of future development programs only if significant progress is made in developing methods that can demonstrate meaningful testability metrics. This does not mean that maintainability demonstration, as described in this appendix, is not useful. The need to demonstrate ease of maintenance and the adequacy of logistical support services such as technical manuals, support equipment, sparing levels and training is still extremely important to maintainability. Furthermore, if the diagnostic system designed into a system cannot detect and isolate even those hard failures induced as part of a maintainability demonstration, then this is an indication that a redesign is warranted.

If it is not possible to adequately demonstrate testability characteristics of the design in terms of the aforementioned metrics, the question still remains then as to how the customer can be given some assurance that the diagnostic system will allow the system to meet its overall system performance requirements. The key is to do a better job early on in development of determining exactly what the system diagnostic needs are, and then to develop a process by which higher level requirements are allocated properly to subsystems. Further, as part of the systems engineering approach to design, wherein an integrated product development (IPD) team is assembled to manage the program and make decisions regarding requirements, allocations, etc., a single individual must be given overall authority for testability. Furthermore, this person must be given equal status in the decision making process, such that testability needs and requirements do not take a back seat to other performance needs. In this manner, any design decisions must consider the impact on testability prior to finalizing any approaches.

B.7.1 Defining Needs. In addition to making sure that testability receives equal consideration, the IPD team needs to determine several items that will contribute to an effective testability design. For instance, the need exists to define what constitutes a failure. In particular, failures that can affect BIT performance, such as drift, must be clearly defined. This has been a problem that has plagued BIT performance in the field. BIT algorithms that are too sensitive may detect and report failures that only occur intermittently due to environmental or other factors, but it may not be possible to duplicate in the maintenance environment the conditions that caused the failure. A formal process must also be in place to ensure that test verticality is maintained from one maintenance level to the next.

Another area that needs clear definition is in which failures need to be reported by BIT. Should all BIT failures be reported, or only those that degrade safety or mission capability? For example, should a failure be reported in a connector if it occurs intermittently (e.g., an average of once every three flights) or only if the connector has failed three times in five consecutive test attempts? All reportable BIT indications should be carefully reviewed to define the failure state and the appropriate action.

Testability needs also should be determined from field and manufacturing data on like systems. This is a problem, however, as many data collection systems do not adequately report testability

APPENDIX B

problems. Therefore, the data collection system must be devised to collect data such as CNDs. These data must then be analyzed to determine the root causes of such behavior such that corrective actions can be implemented in next generation designs.

B.7.2 Using Test Programs to Verify Testability Design Attributes. Although a formal test program to demonstrate testability features is not practical, full use must be made of all forms of other testing, including reliability demonstration tests and other development tests, to improve the testability design of the system. This requires, however, that the diagnostic system, such as BIT, be available prior to the testing taking place. Once again, close coordination between the individual(s) responsible for the diagnostic design and other disciplines within the IPD team is absolutely essential.

During all testing that includes diagnostics, all failures and the diagnostic system response to those failures, as well as the ability to detect and isolate faults using test support equipment, must be recorded and analyzed accordingly to identify problems and to develop corrective actions. This process includes collecting diagnostic performance data on both hardware and software faults. A training program should be instituted that disseminates to all individuals responsible for data collection the importance of testability information, and how to properly record such data. This form of verification and evaluation (i.e., using laboratory tests, development tests, etc.), as opposed to dedicated demonstration testing, is much more effective for testability features, as such testing provides a means for testing diagnostics for long periods of time without the need for unique diagnostic tests and extra assets.

Other methods regarding testability design and testability improvement can be found in Appendix C, Design Guidelines.

B.7.2.1 Evaluation Methods for Digital Technology. Despite the noted lack of adequate formal methods for testability demonstration, analytical techniques are available for specific technologies at specific levels of design. In particular, fault simulation tools have been used for several years in the assessment of digital designs. They are used at the IC level for manufacturing level test, and at the circuit card level and above for both manufacturing level test and diagnosis for repair.

In general, simulation, as described here, is the process of modeling the behavior of an object. The purpose of using simulation is to save costs by verifying the designs and their specifications in a software environment, prior to committing the design to hardware. Fault simulation of a digital network is the modeling of the network's behavior in the presence of faults, where such faults can be caused by physical defects or environmental influences.

As a means of testability verification, fault simulation is used for measuring or grading the adequacy of a set of test patterns for detecting single "stuck-at" faults. In this way, the percentage of failures that are detectable in the circuit, given a specific test pattern, is reported by a particular fault simulation package. In essence, this is a measure of the fault coverage capability

APPENDIX B

of the test pattern. Fault coverage is measured as the ratio of the number of faults detected by the test pattern to the total number of simulated faults. Note that this number is not always determined the same way in all fault simulators⁹. For instance, some fault simulators determine the number of "fault classes" detected by the test pattern and divide this by the total number of fault classes simulated to get fault coverage. A fault class is one or more faults in a circuit that cause the same fault signature at a primary output of the circuit. Note also that most fault simulators simulate "Stuck at" faults on the inputs and outputs of the devices in the model. This is the most popular fault model, and will represent a majority of the faulty behaviors of digital circuits. However, this technique does not cover all possible faults, and therefore some faults can still occur that are undetectable, even if the fault simulation results in 100% fault coverage. The standard procedure for fault coverage measurement, procedure 5012 of MIL-STD-883, outlines a method for obtaining consistent results from any commercially available fault simulator. This procedure is provided in Section 8.0 of this appendix.

Note that the achievable level of fault coverage is determined by the design of the circuitry, and not just the test patterns. Many commercial packages that provide fault simulation capabilities also report design characteristics that contribute to poor fault coverage values, thus allowing the design engineer to make changes necessary to improve the testability of the circuit.

In addition to identifying design characteristics that inhibit fault coverage potential, many fault simulators are used to build fault dictionaries for the purpose of fault isolation. Fault dictionaries are created by applying tests to the design and then recording the errors in the form of a fault signature. When an actual test is applied using ATE, for example, the errors that result are recorded, and the fault dictionary is then searched in order to find the fault signature that matches the observed fault signature. The corresponding list of candidate faults represents the ambiguity groups that may contain the fault. Note that creation of such fault dictionaries, especially for highly complex designs, can be expensive. Because of this, fault simulation is used more to evaluate the fault detection characteristics of the design, rather than to build fault dictionaries.

Fault simulation is an essential part of evaluating the testability of digital designs, and of developing test programs needed to support such designs. Often, fault simulation is not performed during the development of digital circuits, even when good circuit simulation is. Trying to develop high quality diagnostic tests without fault simulation is extremely difficult and can lead to test strategies inadequate to detect and isolate faults in complex digital designs. Therefore, investment in a commercial fault simulator and integration of fault simulation into the digital design process should be a high priority for the IPD team.¹⁰

⁹ See RADC-TR-89-230, "Fault Simulator Evaluation," Final Technical Report, November 1989, University of South Florida

¹⁰ For further information on fault simulation see: RL-TR-91-6, "Digital Logic Testing and Testability, In-House Report," February 1991, Dr. Warren H. Debany, Jr., and "Digital Systems Testing and Testable Design, Revised Edition," by Abramovici, Breuer and Friedman, IEEE Press, 1990.

APPENDIX B

B.8.0 Fault Coverage Measurement For Digital Microcircuits, Method 5012.1 — Excerpted from MIL-STD-883D, 27 July 1990

B.8.1 Purpose. This test method specifies the procedures by which fault coverage is reported for a test program applied to a microcircuit herein referred to as the device under test (DUT). This method describes requirements governing the development of the logic model of the DUT, the assumed fault model and fault universe, fault classing, fault simulation, and fault coverage reporting. This method provides a consistent means of reporting fault coverage regardless of the specific logic and fault simulator used. Three procedures for fault simulation are described in this method: full fault simulation and two fault sampling procedures. The applicable acquisition document shall specify a minimum required level of fault coverage and, optionally, specify the procedure to be used to determine the fault coverage. A fault simulation report shall be provided that states the fault coverage obtained, as well as documenting assumptions, approximations, and procedures used. When any technique detailed in this method is inapplicable to some aspect of the logic model, or inconsistent with the functionality of the available fault simulator and simulation postprocessing tools, it is sufficient that the user employ an equivalent or comparable technique and note the discrepancy in the fault simulation report. Microcircuits may be tested by nontraditional methods of control or observation, such as power supply current monitoring or the addition of test points that are available by means of special test modes. Fault coverage based on such techniques shall be considered valid if substantiating analysis or references are provided in the fault simulation report.

B.8.1.1 Terms. Terms and abbreviation not defined elsewhere in the text of this test procedure are defined in this section.

- a. Automatic Test Equipment (ATE). The apparatus with which the actual DUT will be tested. ATE includes the ability to apply a test vector sequence (see 8.1.1L).
- b. Broadside application. A method of applying a test vector sequence where input stimuli change only at the beginning of a simulation cycle or ATE cycle and all changes on primary inputs of the DUT are assumed to be simultaneous. Nonbroadside application occurs when test vectors are conditioned by additional timing information such as delay (with respect to other primary inputs), return-to-zero, return-to-one, and surround-by-complement.
- c. Detection. An error at an observable primary output of a logic model caused by the existence of a logic fault. A hard detection is where an observable output value in the fault-free logic model is distinctly different from the corresponding output value in the faulty logic model. An example of a hard detection is where the fault-free logic model's output value is 0 and the faulty logic model's output value is 1, or where the fault-free logic model's output value is 1 and the faulty logic model's output value is 0. If the high-impedance state (Z) can be sensed by the ATE, then a hard detection can involve the Z state as well. A potential detection is an error where the fault-free output is 0 or 1 and the faulty output value is unknown (X), or Z if Z cannot be sensed by the ATE.

APPENDIX B

- d. Established test algorithm. An algorithm, procedure, or test vector sequence, that when applied to a logic component or logic partition has a known fault coverage or test effectiveness. This fault coverage or test effectiveness is denoted herein as the established fault coverage or established test effectiveness for the established test algorithm. For example, an established test algorithm for a RAM may be a published memory test algorithm, such as GALPAT, that has been shown by experience to detect essentially all RAM failures and therefore is assessed an established test effectiveness of 100 percent. An Arithmetic Logic Unit (ALU) may be tested by means of a precomputed test vector sequence for which fault coverage has been previously determined. More than one established test algorithm may exist for a logic component or logic partition, each with a different established fault coverage or test effectiveness.
- e. Failure hierarchy: Failure mechanism, physical failure, logical fault, error. The failure hierarchy relates physical defects and their causes to fault simulators and observable effects. A failure mechanism is the actual cause of physical failure; an example is electromigration of aluminum in a microcircuit. A physical failure (or simply failure) is the actual physical defect caused by a failure mechanism; an example is an open metal line. A logical fault (or simply fault) is a logical abstraction of the immediate effect of a failure; an example is "stuck-at-one" behavior of a logic gate input in the presence of an open metal line. An error is a difference between the behavior of a fault-free and faulty DUT at one or more observable primary outputs of the DUT.
- f. Fault coverage. For a logic model of a DUT, a fault universe for the logic model of the DUT, and a given test vector sequence, fault coverage is the fraction obtained by dividing the number of faults contained in the fault universe that are detected by the test vector sequence as a percentage. In this test procedure, fault coverage is understood to be based on the detectable fault equivalence classes (see B.8.3.3.2). Rounding of fault coverage fractions or percentages shall be "toward zero," not "to nearest." For example, if 9,499 faults are detected out of 10,000 faults simulated, the fault coverage is 94.99 percent; if this value is to be rounded to two significant digits, the result shall be reported as 94 percent, not 95 percent.
- g. Logic line, node. Logic lines are the connections between components in a logic model, through which logic signals flow. Logic lines are the idealized "wires" in a logic model. A set of connected logic lines is a node.
- h. Logic: Combinational and sequential. Combinational digital logic contains only components that do not possess memory, and in which there are no feedback paths. Sequential digital logic contains at least one component that contains memory, or at least one feedback path, or both. For example, a flip-flop is a component that contains memory, and cross-coupled logic gates introduce feedback paths.
- i. Macro. A logic modeling convention representing a model contained within another model. A macro boundary does not necessarily imply the existence of a physical boundary in the logic model. A main model is a logic model that is not contained within a larger model. Macros may be nested (that is, a macro may contain submacros).

APPENDIX B

- j. Primary inputs, primary outputs. Primary inputs to a logic model represent the logic lines of a DUT that are driven by the ATE's drivers and thus are directly controllable test points. The inputs to the "main model" of the logic model of the DUT are the primary inputs, and the outputs from the main model are the primary outputs. Internal nodes that can be driven or sensed by means of special test nodes shall be considered to be control or observation test points.
- k. Test effectiveness. A measure similar to fault coverage, but used in lieu of fault coverage in cases where physical failures cannot be modeled accurately as logical faults. For example, many RAM and Programmable Logic Array (PLA) failures cannot be idealized conveniently in the same way as gate-level failures. However, established test algorithms may be used to detect essentially all likely physical failures in such structures.
- l. Test vector sequence. The (ordered) sequence of stimuli (applied to a logic model of a DUT) or stimulus/response values (applied to, and compared for, the actual DUT by the ATE).
- m. Undetectable and detectable faults. An undetectable fault is defined herein as a logical fault for which no test vector sequence exists that can cause at least one hard detection or potential detection (see B.8.1.1c). Otherwise (that is, some test vector sequence exists that causes at least one hard detection, or potential detection, or both), the fault is defined herein to be a detectable fault (see B.8.3.3.3).

B.8.2 Apparatus

B.8.2.1 Logic Simulator. Implementation of this test procedure requires the use of a facility capable of simulating the behavior of fault-free digital logic in response to a test vector sequence; this capability is herein referred to as logic simulation.

In order to simulate sequential digital logic, the simulator must support simulation of a minimum of four logic states: zero (0), one (1), high-impedance (Z), and unknown (X). In order to simulate combinational digital logic only, the simulator must support simulation of a minimum of two logic states: 0 and 1.

At the start of logic simulation of a logic model of a DUT containing sequential logic, the state of every logic line and component containing memory shall be X; any other initial condition, including explicit initialization of any line or memory element to a 0 or 1, shall be documented and justified in the fault simulation report.

In order to simulate wired connections or bus structures, the simulator must be capable of resolving signal conflicts introduced by such structures. Otherwise, modeling workarounds shall be permitted to eliminate such structures from the logic model (see B.8.3.1.2).

In order to simulate sequential digital logic, the simulator must support event-directed simulation. As a minimum, unit-delay logic components must be supported.

APPENDIX B

Simulation of combinational-only logic, or simulation of sequential logic in special cases (such as combinational logic extracted from a scannable sequential logic model) can be based on nonevent-directed simulation, such as levelized, zero-delay, or compiled-code methods. The fault simulation report shall describe why the selected method is equivalent to the more general event-directed method.

B.8.2.2 Fault Simulator. In addition to the capability to simulate the fault-free digital logic, the capability is also required to simulate the effect of single, permanent, stuck-at-zero and stuck-at-one faults on the behavior of the logic; this capability is herein referred to as fault simulation. Fault simulation shall reflect the limitations of the target ATE. It is not necessary that the fault simulator directly support the requirements of this test procedure in the areas of hard versus potential detections, fault universe selection, and fault classing. However, the capability must exist, at least indirectly, to report fault coverage in accordance with this procedure. Where approximations arise (for example, where fault classing compensates for a different method of fault universe selection) such differences shall be documented in the fault simulation report, and it shall be shown that the approximations do not increase the fault coverage obtained.

B.8.3 Procedure**B.8.3.1 Logic Model.**

B.8.3.1.1 Level of Modeling. The DUT shall be described in terms of a logic model composed of components and connections between components. Primary inputs to the logic model are assumed to be outputs of an imaginary component (representing the ATE's drivers), and primary outputs of the logic model are assumed to be inputs to an imaginary component (representing the ATE's comparators). Some logic simulators require that the ATE drivers and comparators be modeled explicitly; however, these components shall not be considered to be part of the logic model of the DUT.

B.8.3.1.2 Logic Lines and Nodes (see B.8.1.1g). All fan-out from a node in a logic model is ideal, that is, fan-out branches associated with a node emanate from a single point driven by a fan-out origin. All fan-in to a node in a logic model is ideal; that is, multiple fan-in branches in a node drive a single line. Figure B-10 shows a node that includes fan-in branches, a fan-out origin, and fan-out branches. Because fan-in and fan-out generally are not ideal in actual circuit layout, the actual topology of the circuit should be modeled, if it is known, by appropriately adding single-input noninverting buffers to the logic model.

B.8.3.1.3 G-logic and B-logic Partitions. Simple components of the logic model (logic primitives such as AND, OR, NAND, NOR, XOR, buffers, or flip-flops; generally the indivisible primitives understood by a simulator) are herein referred to as gate logic (G-logic). Complex components of the logic model (such as RAM, ROM, or PLA primitive components, and behavioral models - relatively complex functions that are treated as "black boxes" for the purpose of fault simulation) are referred to herein as block logic (B-logic).

APPENDIX B

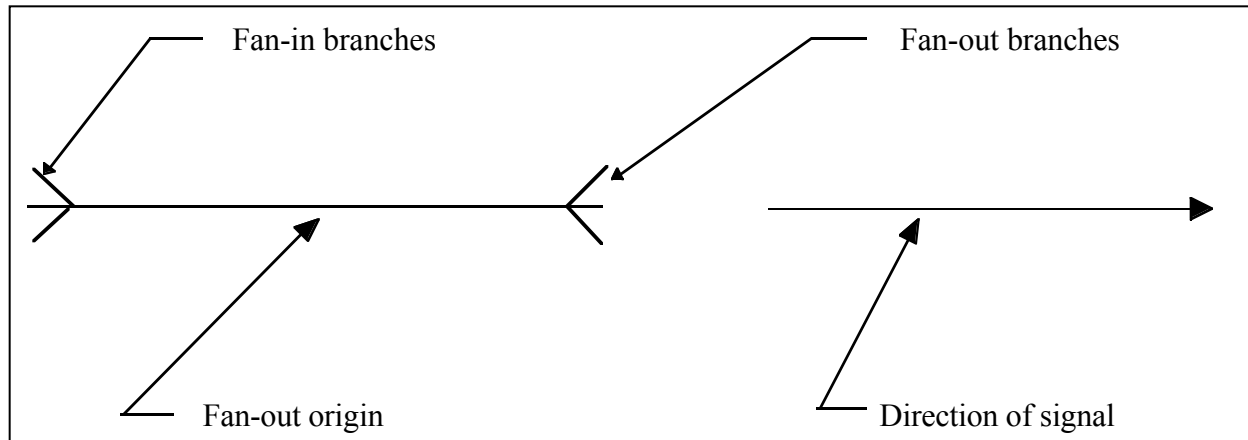

FIGURE B-10. Node Consisting of Fan-in Branches, a Fan-out Origin, and Fan-out Branches.

For the purpose of fault simulation, the logic model shall be divided into nonoverlapping logic partitions; however, the entire logic model may consist of a single logic partition. The logic partitions contain components and their associated limits; although lines may span partitions, no component is contained in more than one partition. A G-logic partition contains only G-logic; any other logic is a B-logic partition.

A logic partition consisting of G-logic, or B-logic, or G-logic and B-logic that, as a unit, is testable using an established testing algorithm, with known fault coverage or test effectiveness, may be treated as a single B-logic partition.

B.8.3.1.4 Model Hierarchy. The logic model may be hierarchical (that is, consisting of macro building blocks), or flat (that is, a single level of hierarchy with no macro building blocks). Hierarchy does not impose structures on lines; for example, there is no implied fan-out origin at a macro input or output. Macros that correspond to physical partitions in a model shall use additional buffers (or an equivalent method) to enforce adherence to the actual DUT's fan-out.

B.8.3.1.5 Fractions of Transistors. The fraction of transistors comprising each G-logic and B-logic partition, with respect to the total count of transistors in the DUT, shall be determined or closely estimated; the total sum of the transistor fractions shall equal 1. Where the actual transistor counts are not available, estimates may be made on the basis of gate counts or microcircuit area; the assumptions and calculations supporting such estimates shall be documented in the fault simulation report. The transistor fractions shall be used in order to weight the fault coverage measured for each individual logic partition (see B.8.3.5).

B.8.3.2 Fault Model.

B.8.3.2.1 G-logic. The fault model for G-logic shall be permanent stuck-at-zero and stuck-at-one faults on logic lines. Only single stuck-at faults are considered in calculating fault coverage.

APPENDIX B

B.8.3.2.2 B-logic. No explicit fault model is assumed for B-logic components. However, an established test algorithm shall be applied to each B-logic component or logic partition. If a B-logic partition contains logic lines or G-logic components, or both, justification shall be provided in the fault simulation report as to how the established test algorithm that is applied to the B-logic partition detects faults associated with the logic lines and G-logic components.

B.8.3.2.2.1 Built-in Self-test. A special case of B-logic is a partition that includes a linear-feedback shift register (LFSR) that performs signature analysis for compression of output error data. Table B-XVI lists penalty values for different LFSR degrees. If the LFSR implements a primitive GF(2) polynomial of degree "k", where there is at least one flip-flop stage between inputs to a multiple-input LFSR, then the following procedure shall be used in order to determine a lower bound on the established fault coverage of the logic partition:

Step 1: Excluding the LFSR, but including any stimulus generation logic considered to be part of the logic partition, determine the fault coverage of the logic partition by fault simulation without signature analysis; denote this fault coverage by C.

Step 2: Reference Table B-XVI. For a given degree "k" obtain the penalty value "p". The established fault coverage of the logic partition using a LFSR of degree "k" shall be reported as (1-p)C. That is, a penalty of (100p) percent is incurred in assessing the effectiveness of signature analysis if the actual effectiveness is not determined.

TABLE B-XVI. Penalty Values, P, for LFSR Signature Analyzers Implementing Primitive Polynomial of Degree k.

k	p
k < 8	1.0
k = (8 . . . 15)	0.05
k = (16 . . . 23)	0.01
k > 23	0.0

B.8.3.3 Fault Universe Selection and Fault Equivalence Classing. Fault coverage shall be reported in terms of equivalence classes of the detectable faults. This section describes the selection of the initial fault universe, the partitioning or collapsing of the initial fault universe into fault equivalence classes, and the removal of undetectable faults in order to form the detectable fault universe. These three stages constitute the fault simulation reporting requirements; however, it is generally more efficient to obtain the set of faults that represent the fault equivalence classes directly without explicitly generating the initial fault universe.

B.8.3.3.1 Initial Fault Universe. The initial fault universe shall consist of single, permanent, stuck-at-zero and stuck-at-one faults on every logic line (not simply on every logic node) in the G-logic partitions of the logic model. A bus, which is a node with multiple driving lines, shall be considered, for the purpose of fault universe generation, to be a multiple-input, single-output logic gate. The initial fault universe shall include stuck-at-zero and stuck-at-one faults on each fan-in and fan-out branch and the fan-out origin of the bus (see Figure B-10).

APPENDIX B

The fault universe does not explicitly contain any faults within B-logic partitions. However, all faults associated with inputs and outputs of B-logic components either are contained in a G-logic partition or shall be shown to be considered by established test algorithms that are applied to the B-logic partitions.

No faults shall be added or removed by considering or not considering logic model hierarchy. No extra faults shall be associated with any primary input or output line, macro input or output line, or logic line that spans logic partitions where the logic partitions do not correspond to a physical boundary. No more than one stuck-at-zero and one stuck-at-one fault per logic line shall be contained in the initial fault universe.

B.8.3.3.2 Fault Equivalence Classes. The initial fault universe shall be partitioned or collapsed into fault equivalence classes for reporting purposes. The fault equivalence classes shall be chosen such that all faults in a fault equivalence class cause apparently identical erroneous behavior with respect to the observable outputs of the logic model. One fault from each fault equivalence class shall be selected to represent the fault class for reporting purposes; these faults shall be called the representative faults.

For the purpose of implementing this test procedure it is sufficient to apply simple rules to identify structurally-dependent equivalence classes. An acceptable method for selecting the representative faults for the initial fault universe consists of listing all single, permanent, stuck-at faults as specified in Table B-XVII. Any other fault equivalencing procedure used shall be documented in the fault simulation report. If a bus node exhibits wired-AND or wired-OR behavior in the applicable circuit technology, then faults associated with that bus shall be collapsed in accordance with the AND or OR fault equivalencing rules, respectively. Otherwise, no collapsing of faults associated with a bus shall be performed.

TABLE B-XVII. Representative Faults for the Fault Equivalence Classes.

Stuck-at faults	Type of logic line in logic model
s-a-1	Every input of multiple-input AND or NAND gates
s-a-0	Every input of multiple-input OR or NOR gates
s-a-0, s-a-1	Every input of multiple-input components that are not AND, OR, NAND, or NOR gates
s-a-0, s-a-1	Every logic line that is a fan-out origin
s-a-0, s-a-1	Every logic line that is a primary output

Note: "s-a-0" is stuck-at-zero and "s-a-1" is stuck-at-one.

B.8.3.3.3 Detectable Fault Universe. Fault coverage shall be based on the detectable fault universe. Undetectable faults shall be permitted to be dropped from the set of representative faults; the remaining set of representative faults comprises the detectable fault universe. In order for a fault to be declared as undetectable, documentation shall be provided in the fault simulation report as to why there does not exist any test vector sequence capable of guaranteeing that the fault will cause an error at an observable primary output (see B.8.1.1m). Any fault not documented in the fault simulation report as being undetectable shall be considered detectable for the purpose of calculating fault coverage.

APPENDIX B

B.8.3.4 Fault Simulation.

B.8.3.4.1 Automatic Test Equipment Limitations. Fault coverage reported for the logic model of a DUT shall reflect the limitations of the target ATE. Two common cases are:

- a. Fault detection during fault simulation shall occur only at times where the ATE will be capable of sensing the primary outputs of the DUT; there must be a one-to-one correspondence between simulator compares and ATE compares. For example, if fault coverage for a test vector sequence is obtained using broadside fault simulation (where fault detection occurs after every change of input stimuli, including clock signals), then it is not correct to claim the same fault coverage on the ATE if the test vectors are reformatted into cycles where a clock signal is pulsed during each cycle and compares occur only at the end of each cycle.
- b. If the ATE cannot sense the Z output state (either directly or by multiple passes), then the reported fault coverage shall not include detections involving the Z state. That is, an output value of Z shall be considered to be equivalent to an output value of X.

Any differences in format or timing of the test vector sequence, between that used by the fault simulator and that applied by the ATE, shall be documented in the fault simulation report and it shall be shown that fault coverage achieved on the ATE is not lower than the reported fault coverage.

B.8.4.2 G-Logic.

B.8.4.2.1 Hard Detection and Potential Detections. Fault coverage for G-logic shall include only faults detected by hard detections. Potential detections shall not be considered directly in calculating the fault coverage. No number of potential detections of a fault shall imply that the fault would be detected.

Some potential detections can be converted into hard detections for the purpose of calculating fault coverage. If it can be shown that a fault is only potentially detected by fault simulation but is in fact detectable by the ATE by a difference not involving an X value, then upon documenting those conditions in the fault simulation report that fault shall be considered to be detected as a hard detection and the fault coverage shall be adjusted accordingly.

Faults associated with three-state buffer enable signal lines can cause X states to occur on nodes with fan-in branches, or erroneous Z states to occur on three-state primary outputs that may be untestable on some ATE. These faults may then be detectable only as potential detections, but may be unconvertible into hard detections. In such cases, it is permissible for the fault simulation report to state separately the fraction of the undetected faults that are due to such faults.

B.8.4.2.2 Fault Simulation Procedures. The preferred method of fault simulation for G-logic is to simulate the effect of each representative fault in the G-logic. However, this may not be practical in some cases due to the large number of representative faults, or because of limitations

APPENDIX B

of the logic models or simulation tools. In such cases fault sampling procedures may be used. When fault sampling is used, either the acquisition document shall specify the method of obtaining a random sample of faults or the fault simulation report shall describe the method used. In either case, the complete random sample of faults shall be obtained before beginning the fault simulation procedure involving a random sample of faults.

Use of any fault simulation procedure other than fault simulation procedure 1 (see B.8.4.2.2.1) shall be documented and justified in the fault simulation report.

In this section, it is assumed that the representative faults declared to be undetectable have been removed from the set of faults to be simulated.

B.8.4.2.2.1 Fault Simulation Procedure 1. Simulate each representative fault in a G-logic partition. The procedure used shall be equivalent to the following:

Step 1: Denote by "n" the total number of representative faults in the G-logic partition.

Step 2: Fault simulate each representative fault. Denote by "d" the number of hard detections.

Step 3: Fault coverage for the G-logic partition is given by d/n .

B.8.4.2.2.2 Fault Simulation Procedure 2. Obtain lower bound on actual fault coverage in a G-logic partition using fixed sample size (see Table B-XVIII). The procedure used shall be equivalent to the following:

Step 1: Select a value for the penalty parameter "r" ($r = 0.01$ to 0.05). The corresponding value of "n" in Table B-XVII is the size of the random sample of representative faults.

Step 2: Fault simulation each of the "n" representative faults. Denote by "d" the number of hard detections.

Step 3: The lower bound on the fault coverage is given by $d/n-r$.

TABLE B-XVIII. Sample Sizes Used to Obtain Lower Bound on Fault Coverage Using Fault Simulation Procedure 2.

r	n
0.01	6860
0.015	3070
0.02	1740
0.03	790
0.04	450
0.05	290

Note: "n" is the minimum sample size required for a chosen penalty "r".

APPENDIX B

B.8.4.2.2.3 Fault Simulation Procedure 3. Accept/reject lower bound on fault coverage in a G-logic partition using fixed sample size (see Table B-XIX). The procedure used shall be equivalent to the following:

Step 1: Denote by "F" the minimum required value for fault coverage. From Table B-XIX obtain the minimum required sample size, denoted by "n".

Step 2: Fault-simulate each of the "n" representative faults, and denote by "d" the number of hard detections.

Step 3: If "d" is less than "n" (that is, any faults are undetected), then conclude that the faults coverage is less than "F". Otherwise (that is, all sampled faults are detected), conclude that the fault coverage is greater than or equal to "F".

TABLE B-XIX. Sample Size Used to Accept/Reject Lower Bound on Fault Coverage Using Fault Simulation Procedure 3.

F	n	F'
50.0%	5	87.1%
55.0%	6	89.1%
60.0%	6	89.1%
65.0%	7	90.6%
70.0%	9	92.6%
75.0%	11	93.9%
76.0%	11	93.9%
77.0%	12	94.4%
78.0%	13	94.8%
79.0%	13	94.8%
80.0%	14	95.2%
81.0%	15	95.5%
82.0%	16	95.8%
83.0%	17	96.0%
84.0%	18	96.2%
85.0%	19	96.4%
86.0%	20	96.6%
87.0%	22	96.9%
88.0%	24	97.2%
89.0%	26	97.4%
90.0%	29	97.6%
91.0%	32	97.9%
92.0%	36	98.1%
93.0%	42	98.4%
94.0%	49	98.6%
95.0%	59	98.8%
96.0%	74	99.1%
97.0%	99	99.3%
98.0%	149	99.5%
99.0%	299	99.8%

NOTE: For a given minimum required fault coverage "F" simulate "n" faults. If all faults are detected, then conclude that the actual fault coverage is greater than or equal to "F". Otherwise, conclude that the actual fault coverage is less than "F". The column labeled "F" shows that actual fault coverage that has a 50 percent probability of acceptance.

APPENDIX B

B.8.4.3 B-logic. Fault coverage shall be measured indirectly for each B-logic partition. For a given B-logic partition, the established fault coverage or test effectiveness shall be reported for that B-logic partition only if it is shown that: (a) the test vector sequence applied to the DUT applies the established test algorithm to the B-logic partition, and (b) the resulting critical output values from the B-logic partition are made observable at the primary outputs. Otherwise, the fault coverage for that B-logic partition shall be reported as 0 percent. For each B-logic partition tested in this way, the established test algorithm, proof of its successful application, and the established fault coverage or test effectiveness shall be documented in the fault simulation report.

B.8.5 Fault Coverage Calculation. Let "m" denote the number of logic partitions in the logic model for the DUT. For the i^{th} logic partition, let " F_i " denote its fault coverage (measured in accordance with 8.3.4), and let " T_i " denote its transistor fraction. The fault coverage "F" for the logic model for the DUT shall be calculated as:

$$F = F_1 T_1 \cdot F_2 T_2 \cdot \dots \cdot F_m T_m$$

If fault simulation procedure 1 is performed for each G-logic partition in the logic model of a DUT, then the fault coverage for the logic model of a DUT shall be reported as:

F of all detectable equivalence classes of single, permanent, stuck-at-zero and stuck-at-one faults on the logic lines of the logic model as measured by MIL-STD-883, test method 5012."

If fault simulation procedure 2 or 3 is performed for any G-logic partition, then the fault coverage for the logic model of a DUT shall be reported as:

"No less than F of all detectable equivalence classes of single, permanent, stuck-at-zero and stuck-at-one faults on the logic lines of the logic model, with 95 percent confidence, as measured by MIL-STD-883, test method 5012".

The confidence level of 95 percent shall be identified if any fault simulation procedure other than procedure 1 was performed for any G-logic partition.

B.8.6 Summary. The following details shall be specified in the applicable acquisition document:

- a. Minimum required level of fault coverage and method of obtaining fault coverage.
- b. If a fault sampling method is permitted, guidance on selection of the random sample of faults.
- c. Guidelines, restrictions, or requirements for test algorithms for B-logic types.

APPENDIX D

MAINTAINABILITY PREDICTIONS

FOREWORD

This Appendix is an essential part of MIL-HDBK-470A. The information contained herein is intended for reference only. The maintainability prediction procedure incorporated here was previously identified as Procedure V in MIL-HDBK-472. The procedure has been retyped and reformatted and the paragraph numbering was changed to reflect a stand-alone document. Otherwise it has been incorporated without change.

Maintainability Prediction Procedure V was initially incorporated into MIL-HDBK-472 "Maintainability Prediction" with Notice 1 to that handbook dated 12 January 1984. This incidentally was the only change made to that handbook since it was originally issued on 24 May 1966.

MIL-HDBK-472 Procedure V was developed under the joint sponsorship of Rome Laboratory, formerly Rome Air Development Center (RADC) and the Naval Electronics System Command by Hughes Aircraft. It was specifically developed to overcome deficiencies identified in Procedures I and IV (See RADC-TR-78-169). After Procedure V was incorporated into the handbook, it became the overwhelming procedure of choice for performing maintainability predictions. It is the only prediction procedure addressed by modern automated maintainability analysis tools.

Thus, only Maintainability Prediction Procedure V from MIL-HDBK-472 has been included in this appendix.

APPENDIX D

D.1.0 GENERAL

Scope. This procedure is primarily used to predict maintainability parameters of avionics and ground and shipboard electronics at the organizational, intermediate and depot levels of maintenance. It can also be applied to any application environment and type of equipment including mechanical equipment. This Appendix is for guidance only and cannot be cited as a requirement. If it is, the contractor does not have to comply.

D.1.1 Philosophy and assumptions. The maintainability prediction procedures presented herein permit the maintainability of electronic equipment/systems to be analyzed, including direct accountability of diagnostics, isolation, and test capabilities; replaceable item (RI)¹ construction; packaging; and component failure rates. In addition, the following assumptions and stipulations apply to any predictions made using the procedures:

- a. Failure rates experienced are all in the same proportion to those predicted
- b. Only one failure at a time is considered
- c. Maintenance is performed in accordance with established maintenance procedures
- d. Maintenance is performed by maintainers possessing the appropriate skills and training
- e. Only active maintenance time is addressed; administrative and logistic delays, and clean-up are excluded

Two separate methods are presented. Method A is a prediction method for use in the early stages of the development of an equipment or system. Method B is a detailed prediction method that uses actual detailed design data to predict maintainability parameters.

The application of the procedures presented here permits the user to monitor the overall system maintainability throughout the design and development of that system. The user can identify whether or not the specified maintainability design requirements will be met before the system is complete. Thus, if it appears the maintainability requirements will not be met, the designers can be informed and the necessary changes can be made before they become prohibitively expensive.

D.1.2 Point of application. Both prediction methods (Method A is the early prediction and Method B is the detailed prediction) of this procedure can be applied to any equipment or system level, at any level of maintenance, and for any maintenance concept pertinent to avionics, ground electronics, and shipboard electronics. (While the prediction methods were developed specifically for electronic equipments and systems, there is nothing inherent in the methods that should prevent them from being applicable to electro-mechanical or mechanical equipments or systems).

¹ A replaceable item (RI) is any of those physical entities normally removed and replaced to effect repair at the maintenance level for which the prediction is being made.

APPENDIX D

D.1.3 Basic parameters of measure. Mean time to repair (MTTR) is the primary maintainability parameter that can be predicted using this procedure. The other maintainability parameters that can be predicted using this procedure are: maximum corrective maintenance time at the Φ percentile ($M_{\text{Max}}(\Phi)$), percent of faults isolatable to a single replaceable item (I_1); percent of faults isolatable to $<N$ replaceable items (I_N), mean maintenance labor hours per repair (MLH/repair), mean maintenance labor hours per operating hour (MLH/OH), mean maintenance labor hours per flight hour (MLH/FH). (For details see paragraph 2.2).

D.1.4 Information required. These data items must be provided as part of the maintainability prediction.

D.1.4.1 Method A. To use Method A the following data are necessary:

- a. The number and contents of (either actual or estimated) the primary RIs
- b. The failure rates, either predicted or estimated, associated with each RI
- c. The basic fault isolation test strategy of each RI
- d. The replacement concept, if fault isolation is to a group of RIs
- e. The packaging philosophy
- f. The fault isolation resolution, either estimated or required (i.e., % of faults isolated to one repairable item or the average RI group size)

D.1.4.2 Method B. The data necessary to implement Method B are:

- a. The replacement concept of each RI or group of RIs
- b. The fault detection and isolation outputs associated with each RI
- c. The failure rate of each RI
- d. The maintenance procedure that is followed to remove and replace each RI

D.2.0 BASIC DEFINITIONS AND MODELS

D.2.1 MTTR elements. Corrective maintenance (CM) actions consist of the following tasks: Preparation, Fault Isolation, and Fault Correction (further broken down into Disassembly, Interchange, Reassembly, Alignment, and Checkout). The time to perform each of these tasks is an element of MTTR, so the task times are called MTTR elements.

The definitions and abbreviations for the MTTR elements used in the prediction models are shown in Table D-I.

APPENDIX D

TABLE D-I. MTTR Elements.

MTTR Element (Abbreviation)	Definition
Preparation ($T_{P_{nj}}$)	Time associated with those tasks required to be performed before fault isolation can be executed.
Fault Isolation ($T_{FI_{nj}}$)	Time associated with those tasks required to isolate the fault to the level at which fault correction begins.
Disassembly ($T_{D_{nj}}$)	Time associated with gaining access to the replaceable item or items identified during the fault isolation process.
Interchange ($T_{I_{nj}}$)	Time associated with the removal and replacement of a faulty replaceable item or suspected faulty item.
Reassembly ($T_{R_{nj}}$)	Time associated with closing up the equipment after interchange is performed.
Alignment ($T_{A_{nj}}$)	Time associated with aligning the system or replaceable item after a fault has been corrected.
Checkout ($T_{C_{nj}}$)	Time associated with the verification that a fault has been corrected and the system is operational.
Start-Up ($T_{ST_{nj}}$)	Time associated with bringing a system up to the operational state it was in prior to failure, once a fault has been corrected and the operational status of the system verified.

The n_j subscript indicates that the n^{th} RI is the object of the maintenance action brought about by the j th fault detection and isolation (FD&I) indication or symptom. The term FD&I is defined as those indications, symptoms, printouts, readouts, or the results of manual procedures which separately, or in combination, indicate a fault or failure has occurred and identifies to the maintainer the procedures to follow in performing maintenance.

Table D-II indicates the MTTR elements that must be predicted for each of the different fault isolation cases listed at the top of the table.

TABLE D-II. MTTR Elements for Prediction Procedure.

Isolation to Single RI	Isolation to Group with Group Replacement	Isolation to Group with Iterative Replacement	Isolation with Ambiguity (Requires Further Isolation)	
Preparation	Preparation	Preparation	Preparation	Secondary Preparation
Isolation	Isolation	Isolation	Isolation	Secondary Isolation
Disassembly	Disassembly	Disassembly	Disassembly	Secondary Fault Correction
Interchange	Interchange	Interchange	Interchange	
Reassembly	Reassembly	Reassembly	Reassembly	
Alignment	Alignment	Alignment	Alignment	
Checkout	Checkout	Checkout	Checkout	Start Up
Start Up	Start Up	Start Up	Continue	

APPENDIX D

D.2.2 Basic models. The maintainability prediction contains two separate procedures: (1) Method A is an early procedure for implementation when preliminary design data are available. (2) Method B is a detailed procedure for implementation when detailed design and support data are available. Both of these procedures are time synthesis model techniques and employ the same general MTTR prediction model.

D.2.2.1 Mean time to repair (MTTR).

$$MTTR = \frac{\sum_{n=1}^N \lambda_n R_n}{\sum_{n=1}^N \lambda_n} \quad (\text{Equation D-1})$$

where:

- N = number of replaceable items (RI)
- λ_n = failure rate of the n^{th} RI
- R_n = mean repair time of the n^{th} RI as computed in 2.2.1.1

D.2.2.1.1 Mean repair time for the n^{th} RI.

$$R_n = \frac{\sum_{j=1}^J \lambda_{nj} R_{nj}}{\sum_{j=1}^J \lambda_{nj}} \quad (\text{Equation D-2})$$

where:

- J = number of unique FD&I outputs (see 3.2.3)
- λ_{nj} = failure rate of those n^{th} RI parts which would cause the n^{th} RI to be called out in the j^{th} FD&I output.
- R_{nj} = average repair time of the n^{th} RI when called out in the j^{th} FD&I output as computed in 2.2.1.2

APPENDIX D

D.2.2.1.2 Average repair time for the nth RI.

$$R_{nj} = \sum_{m=1}^{M_{nj}} T_{m_{nj}} \quad (\text{Equation D-3})$$

where:

- M_{nj} = # of steps to perform CM when a failure occurs in the nth RI and results in the jth FD&I outputs. Includes all CM tasks, including operations on other RIs called out in the jth fault isolation result.
- $T_{m_{nj}}$ = Average time to perform the mth CM step for the nth RI given the jth FD&I output.

D.2.2.2 Percent isolation to a single RI.

$$I_1 = \frac{\sum_{k=1}^K \lambda_k}{N \sum_{n=1}^J \lambda_{nj}} \times 100 \quad (\text{Equation D-4})$$

where:

- λ_{nj} = failure rate of those nth RI parts which would cause the nth RI to be called out in the jth FD&I output.
- λ_k = failure rate associated with the kth FD&I output which results in isolation to one RI.
- K = number of FD&I outputs which result in isolation to a single RI.
- J = number of unique FD&I outputs (see 3.2.3)

D.2.2.3 Percent isolation to a group of RIs.

$$I_N = \frac{\sum_{p=1}^P \lambda_p}{N \sum_{n=1}^J \lambda_{nj}} \times 100 \times 100 \quad (\text{Equation D-5})$$

APPENDIX D

where:

- λ_p = failure rate associated with the p^{th} FD&I output which results in isolation to N or less RIs.
 λ_{nj} = same as for I_1
P = number of FD&I outputs which result in isolation to N or less RIs.

Other maintenance parameters that can be predicted using these procedures follow.

D.2.3 Mean maintenance labor hours per repair ($\overline{\text{MLH/repair}}$).

$$\overline{\text{MLH/Repair}} = \frac{\sum_{n=1}^N \lambda_n \overline{\text{MLH}}_n}{\sum_{n=1}^N \lambda_n} \quad (\text{Equation D-6})$$

where:

- N = quantity of RI's
 λ_n = failure rate of n^{th} RI
 $\overline{\text{MLH}}_n$ = mean maintenance labor hours required to repair the n^{th} RI

D.2.3.1 Mean maintenance labor hours required to repair the n^{th} RI.

$$\overline{\text{MLH}}_n = \frac{\sum_{j=1}^J \lambda_{nj} \text{MLH}_{nj}}{\sum_{j=1}^J \lambda_{nj}} \quad (\text{Equation D-7})$$

where:

- J = quantity of FD&I results
 λ_{nj} = failure rate associated with the j^{th} result for the n^{th} RI
 MLH_{nj} = maintenance labor hours required to repair the n^{th} RI given the j^{th} FD&I result

(Method A and Method B procedures can be used by replacing repair times in the appropriate method with the maintenance labor hours required for each repair action.)

APPENDIX D

D.2.4 Mean maintenance labor hours per maintenance action (MLH/MA).

This calculation is the same as for $\overline{\text{MLH}}$ per repair except that time spent as a result of system failure false alarms must also be included in the maintenance labor hours.

Two types of false alarms are considered:

- 1) Type 1 false alarm is detected during normal operations but cannot be repeated during the fault isolation process.
- 2) Type 2 false alarm is detected and isolated to an RI when the RI does not have an actual fault.

$$\overline{\text{MLH/MA}} = \frac{\sum_{n=1}^N (1 + F_{2n}) \lambda_n \overline{\text{MLH}}_n + \sum_{n=1}^N F_{1n} \lambda_n \overline{\text{MLH}}_D}{\sum_{n=1}^N (1 + F_{2n}) \lambda_n + \sum_{n=1}^N F_{1n} \lambda_n} \quad (\text{Equation D-8})$$

where:

F_{1n} = frequency of occurrence of type 1 false alarms $\underline{1/}$

F_{2n} = frequency of occurrence of type 2 false alarms $\underline{1/}$

$\underline{1/}$ is expressed as a fraction of the n^{th} RI failure rate

$\overline{\text{MLH}}_D$ = mean maintenance labor hours associated with Type 1 false alarms.

$\overline{\text{MLH}}_n$ = mean maintenance labor hours required to repair the n^{th} RI

λ_n = failure rate associated with the j^{th} result for the n^{th} RI

D.2.5 False alarm rates. False alarms are dependent on the system type, operating environment, maintenance environment, system design and fault detection and isolation implementation. Therefore, a standard set of false alarm values would be impossible to derive.

D.2.6 Mean maintenance labor hours per operating hour (MLH/OH). $\overline{\text{MLH/OH}}$ includes the entire labor power that is required to maintain a system; corrective maintenance, preventive maintenance, and maintenance caused by false alarms.

$$\overline{\text{MLH/OH}} = \sum_{n=1}^N (1 + F_{2n}) \lambda_n \overline{\text{MLH}}_n + \sum_{n=1}^N F_{1n} \lambda_n \overline{\text{MLH}}_D + \sum_{r=1}^{\text{PM}} F_r \overline{\text{MLH}}_r \quad (\text{Equation D-9})$$

APPENDIX D

where:

λ_n'	=	λ_n expressed in failures per operating hour
F_r	=	frequency of r^{th} preventive maintenance
MLN_r	=	mean maintenance labor hours to perform r^{th} preventive maintenance type
PM	=	quantity of unique preventive maintenance types
N	=	quantity of RI's
F_{1n}	=	frequency occurrence of type 1 false alarms $\underline{1/}$
F_{2n}	=	frequency of occurrence of type 2 false alarms $\underline{1/}$
MLH_D	=	mean maintenance labor hours associated with type 1 false alarms
MLH_n	=	mean maintenance labor hours required to repair the n^{th} RI

$\underline{1/}$ expressed as a fraction of the n^{th} RI failure rate.

D.2.7 Mean maintenance labor hours per flight hour (MLH/FH). $\overline{MLH/FH}$ is the same as MLH/OH where $\lambda_n' = \lambda_n$ is expressed in failures per flight hour.

D.2.8 Maximum corrective maintenance time for the percentile ($M_{\text{Max}}(\Phi)$). Two $M_{\text{Max}}(\Phi)$ models are provided. The first yields an approximate value and requires that system repair times be lognormally distributed. The second gives a more accurate value.

D.2.8.1 Approximate $M_{\text{Max}}(\Phi)$. Appendix B of MIL-HDBK-472 contains tables of $M_{\text{Max}}(\Phi)$ values for selected values of system Φ , system MTTR (MEAN), and standard deviation of system repair times (SIGMA). MTTR may be predicted using Method A, and the MTTR models in paragraph 2.2.1. SIGMA is usually determined from data on similar equipments. Approximate $M_{\text{Max}}(\Phi)$ values for values of Φ , MEAN, and SIGMA not covered in the Appendix B of MIL-HDBK-472 may be calculated by using the following equation.

$$M_{\text{Max}}(\Phi) = \exp [\log \text{MTTR} + \Phi \text{SIGMA}]$$

where:

$$\text{SIGMA} = \sqrt{\frac{\sum_{i=1}^N (\log R_{ni})^2 - [(\sum_{i=1}^N \log R_{ni})^2 / N]}{N - 1}} \quad (\text{Equation D-10})$$

D.2.8.2 Accurate $M_{\text{Max}}(\Phi)$. A computerized and a manual means of predicting an accurate $M_{\text{Max}}(\Phi)$ are provided in Appendixes C and D, respectively, of MIL-HDBK-472.

APPENDIX D

D.3.0 APPLICATION. The application of the early and detailed maintainability prediction techniques is described in 3.1 and 3.2 respectively.

D.3.1 Method A - early prediction procedure. This section provides a step-by-step procedure for performing an early prediction of mean time to repair. The tasks involved in performing the early prediction are:

- a. Define the prediction requirements
- b. Define the replacement concept
- c. Determine the prediction parameters
- d. Select the appropriate models
- e. Compute the MTTR (or other parameters)

Descriptions of each of these tasks are provided in the following subsections.

D.3.1.1 Prediction requirement definition. This step of the prediction is in some respects the most important aspect since it establishes a common baseline of understanding the prediction purpose, approach and scope. During this step, the maintainability parameter(s) to be evaluated is defined, the prediction ground rules are established, and the maintenance level for which the prediction is being made is defined.

Parameter definition includes the selection (if required) of the parameter(s) to be evaluated and the establishment of a qualitative and quantitative definition of each parameter. If the prediction is being performed in compliance with a customer statement of work defining the parameter to be analyzed, it must be determined if the stated parameter is consistent with an equivalent parameter contained in this methodology. If not, the prediction models must be changed accordingly. As part of the parameter evaluation, it must be determined which elemental maintenance tasks (e.g., preparation, isolation, etc.) are to be included in the analysis and which are to be excluded.

The latest aspect of this step is to explicitly define the maintenance level for which the prediction is being made. If the level is defined in terms of a specific maintenance organization (e.g., direct support unit, depot, etc.), then the tasks to be performed are readily defined by the maintenance concept as described in the following section. If the level is defined by operating level or location (e.g., on-site, flight-line, etc.), then this level must be redefined in terms of the maintenance organization(s) performing maintenance at the level/location.

D.3.1.2 Replacement concept definition. The maintenance concept must be established, so that in conjunction with a definition of the prediction requirements (paragraph D.3.1.1), a baseline is established which defines the prediction to be performed. With respect to the maintainability

APPENDIX D

prediction, the primary output of the maintenance concept is the definition of how a repair is effected and what the replaceable items are.

As part of this process, a complete set of replaceable items is identified. If the maintenance concept allows for fault isolation to a group of RIs and repair by group replacement, then the RI groups can be reclassified as RIs if each of the groups is independent of other groups.

D.3.1.3 Determination of the prediction parameters. This step involves:

- a. Defining the RIs
- b. Determining the predicted or estimated failure rate associated with each RI
- c. Defining fault isolation test methodology for each RI
- d. Defining the replacement concept
- e. Defining the packaging philosophy
- f. Determining the estimated or required fault isolation resolution (i.e., X% to 1 RI or average RI group size).

Forms similar to those in Figures D-1 and D-2 should be used for the data collection process. Data are collected on these forms at the level for which predictions are performed. For example, if a repair time is to be computed for every equipment within a system, then a separate data collection form should be used for each equipment. Data should be tabulated in the following manner.

- a. First tabulate all the primary RIs and their associated failure rates in the respective columns of Figure D-1 (V refers to the method).
- b. Next describe all methods (V) for performing each elemental activity (m) in Figure D-2. (Note: some maintenance actions do not include all maintenance elements).
- c. Next enter the appropriate number of headings (V_m) for each elemental activity along the top of Figure D-1.
- d. For each elemental activity (m, v) synthesize times (T_{mv}) using times, selected in accordance with paragraph 3.2.6, noting them in the respective column of Figure D-2.
- e. Next enter the associated failure rate of each RI for the elemental activity that it pertains to in Figure D-1.

APPENDIX D

Item Nomenclature				Preparation				Fault Isolation				Disassembly	
RI Description	λ	Qty	$\lambda \times$ Qty	λ_{P1n}	λ_{P2n}	...	$\lambda_{V_{Ppn}}$	λ_{FI1n}	λ_{FI2n}	...	$\lambda_{V_{FIpn}}$	λ_{D1n}	λ_{D2n}
RI ₁													
RI ₂													
RI ₃													
RI ₄													
.													
.													
.													
RI _n													
Total $\Sigma \lambda$													

FIGURE D-1: RI Data Analysis Sheet - A.

MTTR Element (m)	v	Description of the v th Method	T _{m_v}	λ_{m_v}
		(For additional data, see #12 of bibliography)		

FIGURE D-2: RI Data Analysis Sheet - B.

These completed data sheets provide the basis for the early prediction technique. Once they are complete, the submodels can be applied.

D.3.1.4 General prediction model and submodel selection. The general form of the prediction model is:

$$MTTR = \bar{T}_p + \bar{T}_{FI} + \bar{T}_{FC} + \bar{T}_A + \bar{T}_{co} + \bar{T}_{ST} = \sum_{m=1}^M \bar{T}_m \quad \text{(Equation D-11)}$$

APPENDIX D

where:

\bar{T}_p	=	Average Preparation Time
\bar{T}_{FI}	=	Average Fault Isolation Time
\bar{T}_D	=	Average Disassembly Time
\bar{T}_I	=	Average Interchange Time
\bar{T}_R	=	Average Reassembly Time
\bar{T}_A	=	Average Alignment Time
\bar{T}_{CO}	=	Average Checkout Time
\bar{T}_{ST}	=	Average Startup Time
\bar{T}_{FC}	=	$\bar{T}_D + \bar{T}_I + \bar{T}_R$
\bar{T}_m	=	Average time of the m^{th} element of MTTR

Variations of the model are limited to deleting the time elements for elemental activity terms that are not necessary to complete certain maintenance actions.

The selection of submodels is dependent on the replacement policy imposed. The appropriate submodels for computing the average time for the elemental activities and the MTTR submodel term definitions are given in Figures D-3 and D-4, respectively.

The submodels presented are of a general form and can generally be applied to any equipment level (i.e., system, subsystem, equipment, etc.). The only limitation being that if the fault isolation result (\bar{S}_G) or the average number of iterations required to correct a fault (\bar{S}_I) are computed, the prediction level must be consistent with the RI grouping rules presented in paragraph 3.1.5.1. Otherwise, the elemental activity submodels are applied at the lowest level for which an MTTR prediction is desired.

D.3.1.5 MTTR computation. The MTTR is computed at the level at which \bar{S}_G or \bar{S}_I is established. For example, if \bar{S}_G or \bar{S}_I can be estimated for each equipment within a system, then the lowest level that the MTTR can be predicted is the equipment level. Higher level predictions of MTTR, such as system level MTTR, can be computed by taking a failure rate weighted average of the equipment MTTRs within the system.

APPENDIX D

Maintenance Philosophy	Preparation T_P	Fault Isolation T_{FI}	Disassembly/Reassembly T_D/T_R	Interchange T_I	Alignment T_A	Check Out T_C	Startup T_{ST}
Isolation for Single RI	↑	↑	$\bar{T}_m = \frac{V_m \sum_{v=1}^m \lambda_{mv} T_{mv}}{V_m \sum_{v=1}^m \lambda_{mv}}$ $m = D, R$	$\bar{T}_I = \frac{V_I \sum_{v=1}^{V_I} \lambda_{Iv} T_{Iv}}{V_I \sum_{v=1}^{V_I} \lambda_{Iv}}$	↑		↑
			$\bar{T}_m = \frac{A}{\sum_{s=1}^A} \left[1 - \left(\frac{\lambda_T - \lambda_s}{\lambda_T} \right)^{S_G} \right] T_{m_s}$ $m = D, R$	$\bar{T}_I = (\bar{S}_I) \frac{V_I \sum_{v=1}^{V_I} \lambda_{Iv} T_{Iv}}{V_I \sum_{v=1}^{V_I} \lambda_{Iv}}$		$\bar{T}_C = \frac{V_C \sum_{v=1}^{V_C} \lambda_{Cv} T_{Cv}}{V_C \sum_{v=1}^{V_C} \lambda_{Cv}}$	
Group Replacement			$m = \frac{V_m \sum_{v=1}^m \lambda_{mv} T_{mv}}{V_m \sum_{v=1}^m \lambda_{mv}}$ $m = D, R$	↓		↓	
			$\bar{T}_m = \frac{V_m \sum_{v=1}^m \lambda_{mv} T_{mv}}{\left(\frac{A+1}{2} \right) \frac{V_m \sum_{v=1}^m \lambda_{mv} T_{mv}}{V_m \sum_{v=1}^m \lambda_{mv}}}$ $m = D, R$	↑	$\bar{T}_{IA} = \frac{V_A \sum_{v=1}^{V_A} \lambda_{Av} T_{Av}}{V_A \sum_{v=1}^{V_A} \lambda_{Av}}$	↑	$\bar{T}_{ST} = \frac{V_{ST} \sum_{v=1}^{V_{ST}} \lambda_{STv} T_{STv}}{V_{ST} \sum_{v=1}^{V_{ST}} \lambda_{STv}}$
Isolation to a Group of RIs	$\bar{T}_P = \frac{V_P \sum_{v=1}^{V_P} \lambda_{Pv} T_{Pv}}{V_P \sum_{v=1}^{V_P} \lambda_{Pv}}$	$\bar{T}_{FI} = \frac{V_{FI} \sum_{v=1}^{V_{FI}} \lambda_{FIv} T_{FIv}}{V_{FI} \sum_{v=1}^{V_{FI}} \lambda_{FIv}}$					
			$\bar{T}_m = (\bar{S}_I) \frac{V_m \sum_{v=1}^m \lambda_{mv} T_{mv}}{V_m \sum_{v=1}^m \lambda_{mv}}$ $m = D, R$	$\bar{T}_I = (\bar{S}_I) \frac{V_I \sum_{v=1}^{V_I} \lambda_{Iv} T_{Iv}}{V_I \sum_{v=1}^{V_I} \lambda_{Iv}}$		$\bar{T}_C = (\bar{S}_I) \frac{V_C \sum_{v=1}^{V_C} \lambda_{Cv} T_{Cv}}{V_C \sum_{v=1}^{V_C} \lambda_{Cv}}$	
Derivative Replacement			$\bar{T}_m = \frac{V_m \sum_{v=1}^m \lambda_{mv} T_{mv}}{V_m \sum_{v=1}^m \lambda_{mv}}$ $m = D, R$				
			$\bar{T}_m = (\bar{S}_I) \frac{V_m \sum_{v=1}^m \lambda_{mv} T_{mv}}{V_m \sum_{v=1}^m \lambda_{mv}}$ $m = D, R$	↓	↓	↓	↓

FIGURE D-3. MTTR Submodels.

APPENDIX D

T_{Pv}	time required to prepare a system for fault isolation using the v^{th} method
T_{FIv}	time required to isolate a fault using the v^{th} method
T_{Dv}	time required to perform disassembly using the v^{th} method
T_{Rv}	time required to perform reassembly using the v^{th} method
T_{Iv}	time required to interchange an RI using the v^{th} method
T_{Av}	time required to align or calibrate an RI using the v^{th} method
T_{Cv}	time required to check a repair using the v^{th} method
T_{STv}	time required to start up a system using the v^{th} method
λ_{Pv}	failure rate of RIs associated with the v^{th} method of performing preparation
λ_{FIv}	failure rate of RIs associated with the v^{th} method of performing fault isolation
λ_{Dv}	failure rate of RIs associated with the v^{th} method of performing disassembly
λ_{Rv}	failure rate of RIs associated with the v^{th} method of performing reassembly
λ_{Iv}	failure rate of RIs associated with the v^{th} method of performing interchange
λ_{Av}	failure rate of RIs associated with the v^{th} method of performing alignment
λ_{Cv}	failure rate of RIs associated with the v^{th} method of performing checkout
λ_{STv}	failure rate of RIs associated with the v^{th} method of performing set-up
V_P	the number of unique ways to perform preparation
V_{FI}	the number of unique ways to perform fault isolation
V_D	the number of unique ways to perform disassembly
V_R	the number of unique ways to perform reassembly
V_I	the number of unique ways to perform interchange
V_A	the number of unique ways to perform alignment
V_C	the number of unique ways to perform check-out
V_{ST}	the number of unique ways to perform start-up
\bar{S}_G	the average number of RIs contained in a fault isolation result
\bar{S}_I	the average number of interchanges required to correct a fault
A	the number of unique accesses ($A \leq V_D$ or V_R)
\bar{A}	the average number of unique accesses required per fault isolation result
λ_a	the failure rate of the RIs that require the a^{th} type of access
λ_T	the total system failure rate
T_{Da}	the time required to disassemble the a^{th} access
T_{Ra}	the time required to reassemble the a^{th} access

FIGURE D-4. Definitions of MTTR Submodel Terms.

APPENDIX D

Computing repair times below the level at which S(I or G) is established may give an inaccurate account of repair times. The only exception is when fault isolation is down to a single RI ($\bar{S}_G = 1$) for the entire system, equipment . . .), then the MTTR may be computed at any level since ambiguities between RIs do not exist. Otherwise, the following criteria must be followed:

In order to compute a repair time at a given level, a value for \bar{S} (I or G) must be established at that level. After the level at which the repair times will be computed has been selected, the appropriate models are selected to compute time for each elemental activity at that level with higher level repair time being computed using a failure rate weighted average.

Values for \bar{S}_G , \bar{S}_I , \bar{A} , \bar{T}_D' or \bar{T}_R' , where required, should be computed as detailed in the following subsections.

D.3.1.5.1 Method of computing \bar{S}_G and \bar{S}_I . Two methods are used for computing the average number of RIs in a fault isolation result (\bar{S}_G) and the average number of iterations required to correct a fault (\bar{S}_I). Compute $\bar{S}_{I \text{ or } G}$ using the specified or design requirements, or compute $\bar{S}_{I \text{ or } G}$ by assessing the approximate fault isolation capabilities of the system.

D.3.1.5.1.1 Method 1. The first method of computing \bar{S}_I or \bar{S}_G depends upon how the fault isolation requirements are specified. In the fault isolation resolution is specified as follows:

X_1 % to $\leq N_1$ RIs

N_1 RIs < X_2 % to $\leq N_2$ RIs

N_2 RIs $\leq X_3$ % to $\leq N_3$ RIs

and $X_1 + X_2 + X_3 = 100$

then,

$$\bar{S}_{I \text{ or } G} = \frac{X_1 \left(\frac{N_1 + 1}{2} \right) + X_2 \left(\frac{N_1 + N_2 + 1}{2} \right) + X_3 \left(\frac{N_2 + N_3 + 1}{2} \right)}{100}$$

APPENDIX D

If the fault isolation requirements are specified as follows:

X_1 % to $\leq N_1$ RIs

X_2 % to $\leq N_2$ RIs

100% to $\leq N_3$ RIs

where:

X_1 % < X_2 % < 100%

then,

$$\bar{S}_{I \text{ or } G} = \frac{X_1 \left(\frac{N_1 + 1}{2} \right) + (X_2 - X_1) \left(\frac{N_1 + N_2 + 1}{2} \right) + (100 - X_2) \left(\frac{N_2 + N_3 + 1}{2} \right)}{100}$$

The predicted MTTR using this method of computing S is based on the assumption that the specified fault isolation requirements have been (or will be) met. The resulting prediction is the inherent MTTR that will be realized by achieving the specified requirements. This approach is valuable during the early stages of equipment development for purposes of allocation and assessment of the requirements facility. This approach should not be used when data are available on the actual fault isolation characteristics.

D.3.1.5.1.2 Method 2. The second method of computing \bar{S}_I or \bar{S}_G involves an analysis of the fault isolation characteristics of the subject equipment/system as follows:

- a. Prepare a simple block diagram depicting the system and how each major function is related (i.e., show functional interfaces).
- b. Group the functions (RIs) into "G" RI sets such that:
 - an estimate of the fault isolation (number of RIs) can be determined for each RI set
 - each RI set is independent of any other RI set
 - each RI set established is the smallest set that can be established
- c. For each RI set (g) estimate the average fault isolation resolution or the average number of RIs per fault isolation result depending on the replacement philosophy in question ($\bar{S}_{(I)g}$ if iterative replacement, $S_{(G)g}$ if group replacement).

APPENDIX D

- d. Compute the average \bar{S}_I , or \bar{S}_G for the system or equipment using a failure rate weighted model.

$$\bar{S}_I \text{ or } \bar{S}_G = \frac{\sum_{g=1}^G \lambda_g \bar{S}_g}{\sum_{g=1}^G \lambda_g} \quad (\text{Equation D-12})$$

For repair times computed at lower levels, the overall \bar{S} does not have to be computed.

D.3.1.5.2 Computation of \bar{A} , \bar{T}_D' and \bar{T}_R' . The average number of accesses (disassemblies and reassemblies) required per fault isolation result (\bar{A}) can be computed as follows.

$$\bar{A} = \frac{\sum_{g=1}^G \lambda_g \bar{A}_g}{\sum_{g=1}^G \lambda_g} \quad (\text{Equation D-13})$$

and,

$$\bar{A}_g = \sum_{a=1}^{A_g} P_{ga} = \sum_{a=1}^{A_g} \left[1 - \frac{(\lambda_g - \lambda_{ga}) \bar{S}_g}{\lambda_g} \right]$$

where:

- \bar{A}_g = average number of accesses required per fault isolation result in g^{th} RI set, ("G" RI sets established the same way as was done for S)
- P_{ga} = the probability that the a^{th} access will be required for any random fault isolation result
- A_g = the number of unique accesses in the g^{th} RI set
- λ_g = the failure rate of the RIs located in the g^{th} RI set
- λ_{ga} = failure rate of the RIs located in a^{th} access location of g^{th} RI set
- \bar{S}_g = average number of RIs per fault isolation result for the g^{th} RI set
- G = total number of RI sets

APPENDIX D

The computation of \bar{T}_D' and \bar{T}_R' is exactly like the method used for \bar{A} with one modification. Each probability is multiplied by its appropriate disassembly or reassembly time. The equation for \bar{T}_D' or \bar{T}_R' is:

$$\bar{T}_D' = \frac{\sum_{g=1}^G \lambda_g \bar{T}_{Dg}'}{\sum_{g=1}^G \lambda_g} \quad (\text{Equation D-14})$$

and,

$$\bar{T}_R' = \frac{\sum_{g=1}^G \lambda_g \bar{T}_{Rg}'}{\sum_{g=1}^G \lambda_g}$$

where:

$$\bar{T}_{Dg}' = \sum_{a=1}^{A_g} \left[1 - \frac{(\lambda_g - \lambda_{ga}) \bar{S}_g}{\lambda_g} \right] T_{D_{ga}} \quad (\text{Equation D-15})$$

The same equation also holds true for reassembly, (\bar{T}_{Rg}')

where:

$T_{D_{ga}}$ = the disassembly time for the a^{th} access of the g^{th} RI set.

$T_{R_{ga}}$ = the reassembly time for the a^{th} access of the g^{th} RI set.

Note here also that if the RIs are grouped into just one set instead of G sets, then all the subscripts "g" will fall-out and the failure rate weighting of the g^{th} RI sets is not necessary.

APPENDIX D

D.3.1.5.3 Determination of MTTR. The MTTR can now be computed by summing up the average times computed from each submodel. Thus, the MTTR is expressed as

$$MTTR = \sum_{m=1}^M \bar{T}_m \quad (\text{Equation D-16})$$

If the repair time computed is for a lower level, then the higher level repair times are computed as follows:

$$MTTR = \frac{\sum_{b=1}^B \lambda_b MTTR_b}{\sum_{b=1}^B \lambda_b}$$

where:

- $MTTR_b$ = mean repair time of the b^{th} lower level
 λ_b = failure rate of the b^{th} lower level
 B = quantity of lower level breakdowns.

D.3.2 Method B - Detailed prediction procedure. This section provides a step by step procedure for performing a detailed prediction of mean time to repair (MTTR). The tasks involved in performing the prediction are:

- a. Define the prediction requirements
- b. Define the replacement concept
- c. Identify the fault detection and isolation outputs (FD&I outputs)
- d. Correlate the FD&I outputs and hardware features
- e. Correlate replaceable items and fault detection and isolation outputs
- f. Prepare a maintenance flow diagram
- g. Prepare time line analyses
- h. Compute the maintainability parameters

Descriptions of each of the tasks are provided in the following subsections.

D.3.2.1 Prediction requirements definition. This step is similar to that required for an early prediction; refer to paragraph 3.1.1.

APPENDIX D

D.3.2.2 Replacement concept definition. This step is similar to that required for an early prediction; refer to paragraph 3.1.2.

D.3.2.3 Fault detection and isolation output identification. This step involves the identification of all the "outputs" which are used in the fault detection and isolation process. Normally, the fault detection and isolation processes are segregated. However, for purposes of maintainability prediction, the fault detection methodology is considered as the first step of fault isolation and is properly included as part of the isolation capability. Any time associated with fault detection (e.g., mean fault detection time) is normally excluded from the prediction model, but can be included if desired.

The term fault detection and isolation outputs is defined as those indications, symptoms, printouts, readouts, or the results of manual procedures which separately or in combination, identify to the maintenance technician the procedure to be followed.

FD&I outputs will vary in form, format, complexity and data content from system to system and some will be more obvious than others. The maintenance actions taken in response to these outputs may depend upon the system maintenance environment and the system operating criticality. It is important, therefore, not only to identify the FD&I outputs but also to ensure that the FD&I outputs identified are the ones that will be used in the intended maintenance environment.

Some of the more common generic FD&I outputs are:

- a. Indicator or annunciator
- b. Diagnostic or BIT output
- c. Meter readings
- d. Circuit breaker and fuse indicators
- e. Display presentation
- f. Alarms
- g. Improper system operation
- h. Improper system response
- i. System operating alerts

To apply the prediction methodology presented herein, the predictor should first identify all primary unique outputs upon which the maintenance technician relies to make decisions on the repair methodology (e.g., perform adjustment, replace RI, proceed to a different method of fault isolation, etc.). Secondary outputs should then be identified for those cases where the primary output yielded a result which did not correct the problem and further isolation is required.

APPENDIX D

D.3.2.4 FD&I outputs and hardware correlation. The key to this prediction procedure, and by far the most demanding of the prediction tasks, is the establishment of a correlation between the FD&I outputs (See paragraph 3.2.7) and the hardware for which the prediction is being made. This step demands a thorough understanding of the system hardware, software, monitoring and diagnostic capabilities, and of the FD&I features inherent to the system. FD&I features are those hardware and software elements, or combinations thereof, which generate or cause to be generated each FD&I output.

This task can be accomplished either from the top down or bottom up. The top down approach involves a fault tree technique where the top of the tree is each unique FD&I output; the next tier identifies the FD&I feature(s) which can yield the subject output; and, the bottom tier identifies the RIs or partial RIs which upon failure would be detected or isolated by the subject FD&I feature. The bottom up approach involves identification of all the circuitry in terms of RIs associated with each FD&I feature, and the analysis of how a failure of each RI presents itself in terms of an FD&I output.

Either approach requires the same five steps to be performed:

- a. Identify all FD&I features
- b. Identify the circuitry associated with each feature
- c. Identify the FD&I sequencing
- d. Establish the RI failure rate associated with each FD&I feature
- e. Correlate the FD&I features with the FD&I outputs

FD&I features are those hardware and software elements, or combinations thereof, which generate or cause to be generated each FD&I output. Typical features include diagnostic program routines, BIT routines, BITE, performance monitoring programs, status monitors, and test points.

After the FD&I features are identified, the circuit schematics are analyzed to identify the components tested or verified by each feature. The outputs of this analysis are then translated into a matrix as shown in Figure D-5. The matrix identifies, for each FD&I feature, the RIs and components which are tested by that feature. Also included in the matrix is an identifier which defines the order in which the FD&I features are utilized during the isolation process.

APPENDIX D

Nomenclature		Fault Detection and Isolation Features								
RI/Component	Failure Rate	Feature 1 Seq No.	Feature 2 Seq No.	Feature 3 Seq No.	Feature 4 Seq No.	Feature 5 Seq No.	Feature N Seq No.	Manual Isolation Failure Rate		
RI No. 1										
Component A										
Component B										
Component C										
Component D										
Component E										
Component F-M										
Component N										
Component P-V										
RI No. 2										
Component A										
Component B										

*Component - Same lower level of assembly

FIGURE D-5. Matrix for Correlating FD&I Features with RIs.

The matrix is used to identify the failure rate of each RI associated with each FD&I feature. The first FD&I feature is examined and the failure rate of each component associated with that feature is entered in the matrix under that feature. The second feature is then examined, etc. If a component is tested by more than one feature, the failure rate is assigned to the first feature which would result in a positive failure indication. If different tests of the same component check different failure modes, then the failure rate is apportioned to each feature based on the relative occurrence of each failure mode. The failure rates for the components under each RI in each FD&I feature column are summed and entered as the failure rate for the RI checked by that particular feature. This assumes the feature either checks a single RI or can check multiple RIs by some sequencing scheme. Components not included under any FD&I features represent failures not isolated with the FD&I features. The failure rates of the failures not isolated by the FD&I features are noted in the manual isolation failure rate column of the matrix to complete the accounting of the total equipment failure rate. All manual isolation cases must be accounted for.

In those cases where the n^{th} failure rate is known to result in several FD&I outputs, but the allocated failure rates are not known, the rationale for the assumed allocation of the failure rates shall be stated.

The next step in the correlation process is to associate the FD&I features with the FD&I outputs. This is accomplished using a fault tree type diagram such as the sample shown in Figures D-6 & D-7. The top of the tree consists of all FD&I outputs; the second tier contains the FD&I features which separately or jointly result in the given FD&I output; and, the bottom tier presents the RIs associated with each FD&I feature and the failure rate associated with that feature. The circles are used to assign numbers to all unique FD&I outputs. The triangles

APPENDIX D

identify the order in which RIs are replaced when the replacement concept calls for iterative replacement.

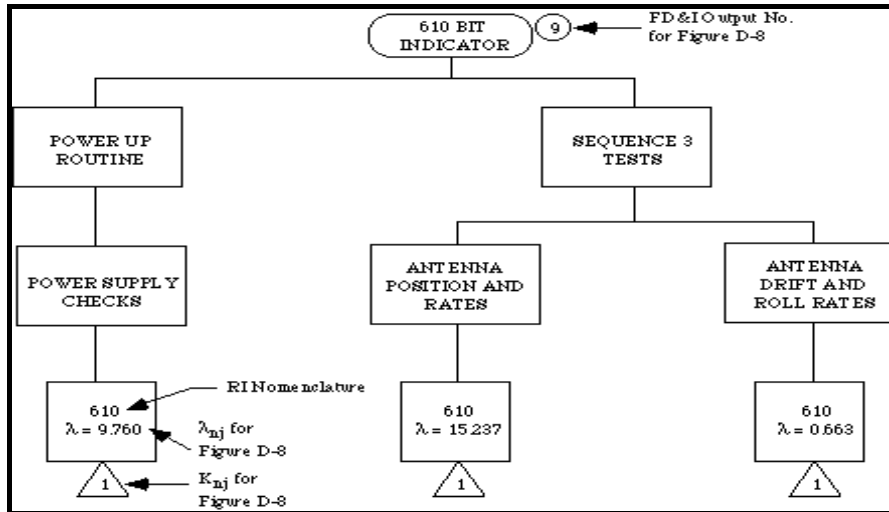

FIGURE D-6. Fault Isolation Output and RI Correlation Tree.

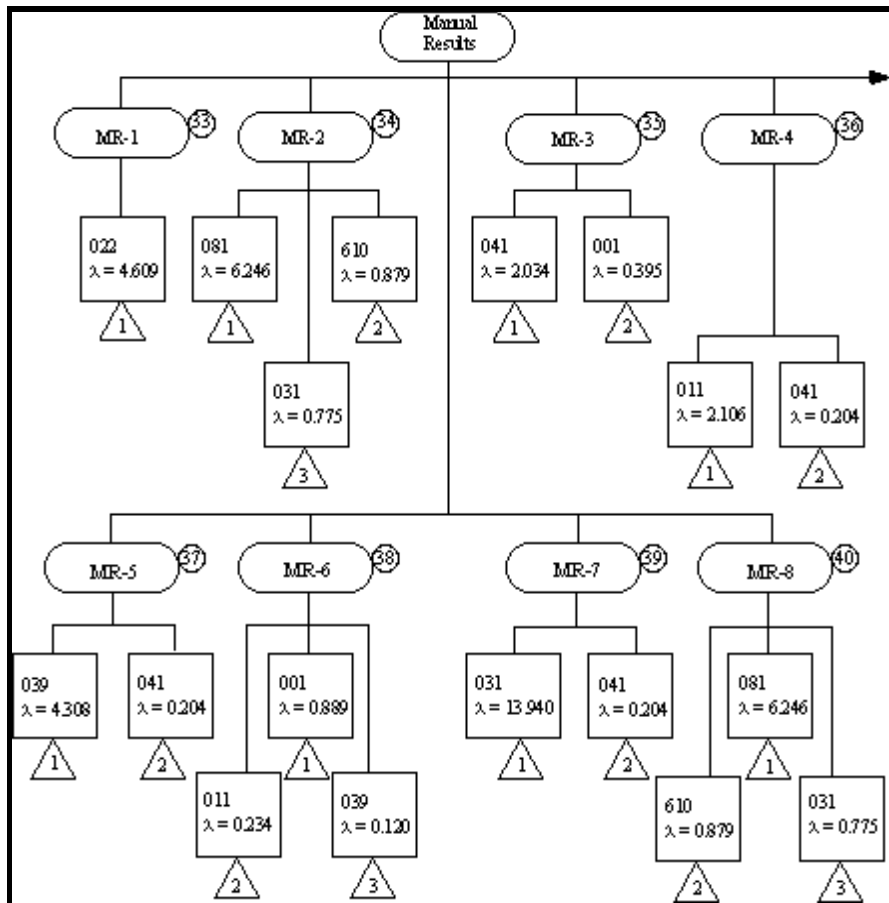

FIGURE D-7. Manual Fault Isolation Output and RI Correlation Tree (Partial).

APPENDIX D

D.3.2.5 Prepare maintenance flow diagrams. Next a maintenance flow diagram (MFD) is prepared to establish the R_{nj} values for insertion in the Maintenance Correlation Matrix (Figure D-10). The MFD is prepared to illustrate the sequence of maintenance required. The symbols used in the MFD are shown in Table D-III.

TABLE D-III. Symbols Used in the MFD.

	<u>Starting Point.</u> (i.e., Failure Occurs and is Detected) or <u>Ending Point</u>
	<u>Activity Block.</u> The top of the block indicates a specific maintenance activity and the bottom indicates the time associated with that activity. This is the only symbol that denotes time.
	<u>FD&I Outputs.</u> Designates the primary or secondary unique FD&I output which defines the subsequent maintenance activity to be performed. The "j" associated with the output is entered in the circle.
	<u>Decision Point.</u> Defines a point in the maintenance flow at which time the maintenance technician must make a decision on which subsequent path to take.
	<u>Path Identifier.</u> Uniquely identifies each path by unique RI(n) and FD&I output (j).
	<u>Continuation.</u> Designates continuation from or to another place in the maintenance flow diagram.

The MFD (as illustrated in Figure D-8) starts on the left side of the figures as a "Failure Occurs and is Detected" event. If isolation is inherent in fault detection, the next item shown in the MFD is the unique FD&I outputs. If isolation is not inherent in detection, the next item in the MFD is the fault detection output. This would be followed by activity blocks which define the procedure followed to achieve fault isolation. The activity block(s) is followed by the unique primary FD&I outputs associated with the maintenance actions that have been executed.

Following the FD&I output symbols are shown the activities required for fault correction and repair verification.

APPENDIX D

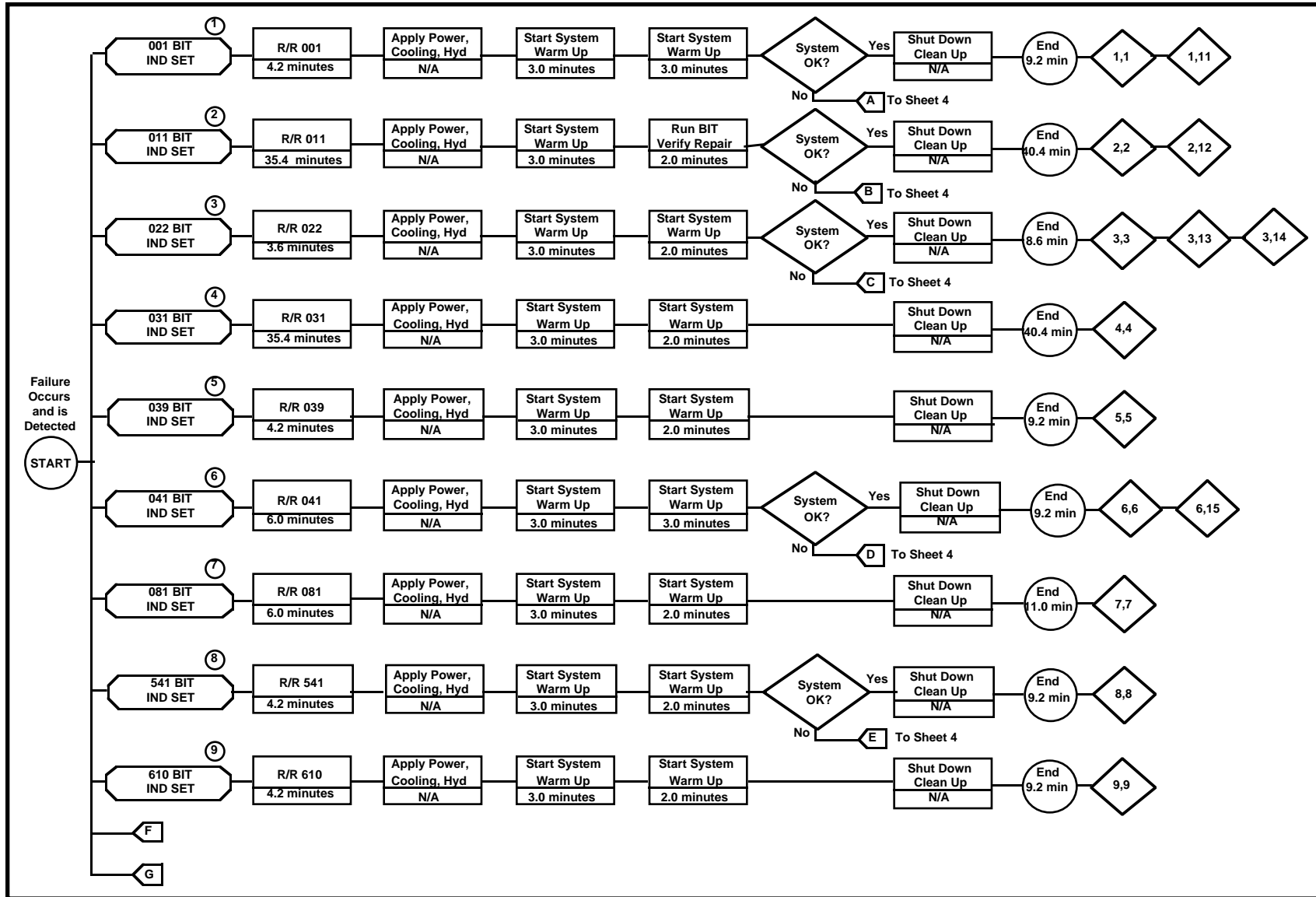

FIGURE D-8. Sample Maintenance Flow Diagram.

APPENDIX D

If an FD&I output results in non-ambiguous maintenance (i.e., primary isolation to a single RI, or group RI replacement), then an "End" symbol will directly follow the fault correction and verification activities. If an FD&I output results in an ambiguous result, a verification decision block is shown after each verification activity (except the last). Any activity (e.g., clean-up) performed after a positive verification decision is shown in an activity block(s) between the decision block and the End symbol. Associated with each End symbol is a path identifier which uniquely identifies each path by RI and FD&I output. For example, the path associated with the second RI and FD&I Output #12 would be designated as 2, 12.

Care must be exercised to ensure that all possible maintenance actions that could be followed as a result of an FD&I output observation have been accounted for, especially those that result in Manual Fault Isolation.

The R_{nj} values are computed by adding the times associated with each activity block from the "Failure Occurs and is Detected" event to the "end" event for the subject (n, j) pair. Note that only the activity blocks have time associated with them. The time entered in the individual activity blocks is computed from a time line analysis prepared in accordance with paragraph 3.2.6. Elemental times entered in the time line analysis are extracted from the following sources in the order given:

- a. Actual times experienced on the subject equipment
- b. Standard times from Tables D-IV and D-V (see Section 4)
- c. Actual times experienced on similar equipment
- d. Other recognized time sources
- e. Engineering judgment

In the establishment of the time line analysis, the number of maintainers must be considered. For example, if a given equipment has two technicians performing maintenance, one technician may perform disassembly to achieve access to the faulty RI while the second technician simultaneously performs other work. In the maintenance flow diagram, this would show as a single maintenance activity with the associated time being the elapsed clock time. If the parameter of interest was MLH/OH, instead of MTTR, then the time entered in the activity block would be the combined MLH in lieu of the elapsed time.

D.3.2.6 Time line analysis. The estimated times used in the two prediction methodologies are synthesized using a time line analysis method. A time line analysis consists of computing the total elapsed time of a maintenance action by accounting for the time required to perform each step. The procedure for performing a time line analysis is as follows:

- a. Identify each task that comprises the maintenance action
- b. Determine the time required to perform each task by either actual times, maintenance time standards, time studies, or engineering judgment

APPENDIX D

- c. Determine which actions can be done simultaneously if more than one maintainer is available
- d. Determine the overall time to perform the maintenance action by summing up the times to perform each action

Figure D-9 is an example of how to synthesize time for a simple physical task. The time associated with each task is extracted from column 3, 4, or 5 of Table D-IV.

RI Name: Module T/R Element Maintenance Action: Interchange			
Description of the Elemental Tasks	Time/Action	Qty	Total Time
Remove Quick Release Coax	0.04	4	0.16
Remove Slide Lock Connector	0.09	1	0.09
Remove Module	0.09	1	0.09
Replace Module	0.11	1	0.11
Replace Slide Lock Connector	0.12	1	0.12
Replace Quick Release Coax	0.04	4	0.16
Total Time			0.73

FIGURE D-9. Example Time Synthesis Analysis.

D.3.2.7 RI and FD&I output correlation. The results of the preceding section are summarized in a matrix which shows the relationship among the RIs for which the prediction is being performed and the total set of FD&I outputs. The matrix (Figure D-10) identifies the RIs across the top and the unique FD&I Outputs down the left column. In reference to the math models (refer to paragraph 2.2) the RIs are the "n" parameters and the FD&I outputs are the "j" parameters. Each RI column is further divided into three columns: Q_{nj} , λ_{nj} , and R_{nj}

Under each RI column, enter the failure rate (λ_{nj}) of the RI (obtained from the FD&I correlation tree) (See Figure D-6) that is associated with each FD&I output. For each unique output which has only one RI associated with it, enter a 1 in the Q_{nj} column for that combination. For those outputs which are associated with 2 or more RIs, the Q_{nj} value is determined by the replacement concept. If the replacement concept is group RI replacement, enter under Q_{nj} the number of RIs associated with each output. For example, if three RIs could contribute to the same FD&I output, then a 3 is entered in the Q_{nj} for each of those RIs. If the replacement concept is iterative replacement, then Q_{nj} is assigned based on the order of replacement. That is, the first RI to be replaced upon recognition of the subject FD&I output is designated $Q_{nj} = 1$, the second $Q_{nj} = 2$ and so forth. In cases of iterative replacement, the values for each Q_{nj} is based on the relative failure rates of the RIs, with the highest failure rate RI assigned as the first replacement item.

APPENDIX D

FD&I Outputs (j)	R _{1j}	1			2			3			4			5		
	λ _{1j}	λ ₁₁	λ ₁₂	R _{1j}	λ ₂₁	λ ₂₂	R _{2j}	λ ₃₁	λ ₃₂	R _{3j}	λ ₄₁	λ ₄₂	R _{4j}	λ ₅₁	λ ₅₂	R _{5j}
1																
2																
3																
4																
5																
6																
.																
.																
.																

FIGURE D-10. Maintenance Correlation Matrix Format.

D.3.2.8 Compute maintainability parameters. Once the MFD and Maintenance Correlation Matrix have been completed, compute the maintainability parameter(s) using the equations in Section 2 of this appendix.

D.4.0 TIME STANDARDS

The time standards are tabulated in Table D-IV. The times tabulated in Table D-IV have corresponding figures referenced which illustrate what each time represents. Table D-V contains composite times of common maintenance actions that may occur. Columns two and four of Table D-V denote which times of Table D-IV were used to synthesize each activity (letters denote removal (A) and replaceable (B) times).

It should be noted that the standard times given are ideals. In actual practice, the task times will probably be longer due to environmental conditions, the need for gloves or other protective clothing that may interfere with performing certain tasks, and less than ideal access. For this reason, as stated in D.3.2.5, elemental times should be extracted from the following sources in the order given:

- a. Actual times experienced on the subject equipment
- b. Standard times from Tables D-IV and D-V
- c. Actual times experienced on similar equipment
- d. Other recognized time sources
- e. Engineering judgment

D.4.1 Maintenance task synthesis. Other maintenance tasks can easily be synthesized by the following method (for an example, see Figure D-9, in paragraph D.3.2.6).

- a. List the actions involved for the maintenance task.
- b. Obtain the times for each action by using Table D-IV (times that are not listed should be established either by actual data, time studies, or engineering judgment).
- c. Compute the time by summing up each individual time.

APPENDIX D

TABLE D-IV. Elemental Maintenance Actions.

Time Standard Number	Description	Standard Times			Reference Figure
		Remove (min.)	Replace (min.)	Interchange (min.)	
FASTENERS					
1	Standard Screws	0.16	0.26	0.42	D-11
2	Hex or Allen Type Screws	0.17	0.43	0.60	D-12
3	Captive Screws	0.15	0.20	0.35	D-13
4	DZUS (1/4 Turnlock)	0.08	0.05	0.13	D-14
5	Tridair Fasteners	0.06	0.06	0.12	D-15
6	Thumbscrews	0.06	0.08	0.14	D-16
7	Machine Screws	0.21	0.46	0.67	D-17
8	Nuts or Bolts	0.34	0.44	0.78	D-18
9	Retaining Rings	NA	0.27	NA	D-19
LATCHES					
10	Drawhook	0.03	0.03	0.06	D-20
11	Spring Clip	0.04	0.03	0.07	D-21
12	Butterfly	0.05	0.05	0.10	D-22
13	ATR (spring loaded, pair)	0.45	0.69	1.14	D-23
14	Lift & Turn	0.03	0.04	0.07	D-24
15	Slide Lock	NA	NA	NA	D-25
TERMINAL CONNECTIONS					
16	Terminal Posts (per lead)	0.22	0.64		D-26
17	Screw Terminals	0.23	0.45	0.68	D-27
18	Termipoint	0.22	0.30		D-28
19	Wirewrap	0.09	0.24		D-29
20	Taperpin	0.07	0.07	0.14	D-30
21	PCB (a) Discretes	0.14	0.17		D-31
22	(b) Flatpacks	0.14 per lead	0.13 per flatpack		D-31
	(c) DIP ICs				
23	• 8 pin	0.46	0.52		D-31
24	• 14 & 16 pin	0.90	0.86		D-31
CONNECTORS					
25	BNC (single pin)	0.07	0.10	10.17	D-32
26	BNC (multipin)	0.07	0.12	0.19	D-32
27	Quick Release Coax	0.04	0.04	0.08	D-33
28	Friction Locking	NA	NA	NA	D-34
29	Friction Locking with one Jack Screw	0.18	0.20	0.38	D-35
30	Thread Locking	0.09	0.17	0.26	D-36
31	Slide Locking	0.09	0.12	0.21	D-37
PLUG IN MODULES					
32	DIP ICs (into DIP sockets)	0.07	0.14	0.21	D-38
	CCAs (without tool) (guided)				
	• 40 pin	NA	NA	NA	D-39
33	• 80 pin	0.04	0.07	0.11	D-39
	C C A s (with tool) (guided)				
34	• 40 pin	0.06	0.07	0.13	D-40
35	• 80 pin	0.09	0.08	0.17	D-40
	CCAs (without tool) (not guided)				
	• 40 pin	NA	NA	NA	D-41
36	• 80 pin	0.04	0.16	0.20	D-41
37	Modules	0.09	0.11	0.20	D-42

APPENDIX D

TABLE D-IV. Elemental Maintenance Actions (continued).

Time Standard Number	Description	Standard Times			Reference Figure
		Remove (min.)	Replace (min.)	Interchange (min.)	
	MISCELLANEOUS				
38	Strip Wire	-	-	0.10	-
39	Cut Wire of Sleeving	-	-	0.04	-
40	Dress Wire with Sleeving	-	-	0.21	-
41	Crimp Lugs	-	-	0.27	D-43
42	Form Leads (per lead)	-	-	0.03	D-44
43	Trim Leads (per lead)	-	-	0.03	-
44	Adhesives	0.55	0.13	0.68	-
45	Conformal Coating	2.20	0.23	2.43	-
46	Soldering (a) Terminal Post	-	-	0.22	D-45
47	(b) PCB	-	-	0.06	D-46
48	Reflow Soldering	-	-	0.25	-
49	Tinning Flatpacks (dipping)	-	-	0.30	-
50	Desoldering (a) Braided Wick	-	-	0.16	D-47
51	(b) Solder Sucker	-	-	0.09	D-48
52	Form Flatpack Leads (Mechanically)	-	-	0.11	D-49
53	Clean Surface	-	-	0.29	-
54	Panels, Doors & Covers	0.04	0.03	0.07	D-50
55	Drawers (Large)	0.09	0.10	0.19	D-51
56	Display Lamps	0.10	0.11	0.21	D-52
57	Threaded Connector Covers	0.11	0.14	0.25	-

NOTE: Data obtained from RADCR-TR-70-89, Maintainability Prediction and Demonstration Techniques

TABLE D-V. Common Maintenance Tasks.

Description	Elements of Removal*	Remove (min.)	Elements of Replacement*	Replace (min.)	Interchange (min.)
1. R/R of transistor from a PCB	50(3), 21A(3), 53	1.19	42(3), 21B(3), 47(3), 43(3), 53	1.16	2.35
2. R/R of a transistor from terminal posts	50(3), 16A(3), 53	1.43	42(3), 16B(3), 43(3), 46(3), 53	3.05	4.48
3. R/R of an axial component from a PCB	50(2), 21A(2), 53	0.89	42(2), 21B(2), 47(2), 43(2), 53	0.87	1.76
4. R/R of an axial component from terminal posts	50(2), 16A(2), 53	1.05	42(2), 16B(2), 43(2), 46(2), 53	1.69	2.74
5. R/R of a radial component from a PCB	50(2), 21A(2), 53	0.89	21B(2), 43(2), 47(2), 53	0.81	1.70
6. R/R of a radial component from terminal posts	50(2), 16A(2), 53	1.05	42(2), 16B(2), 43(2), 46(2), 53	1.69	2.74
7. R/R of a terminal point connection	18A	0.22	39, 20B	0.34	0.56
8. R/R of a wirewrap connection	19A	0.09	39, 38, 19B	0.38	0.47
9. R/R of a 16 pin IC from a PCB	50(16), 24A, 53	3.75	24B, 47(16), 43(16), 53	2.59	6.34
10. R/R of a 16 pin flatpack	50(16), 22A(16), 53	5.09	49, 52, 22B, 48, 53	1.08	6.17
11. R/R an 8 pin IC from a PCB	50(8), 23A, 53	2.03	23B, 47(8), 43(8), 53	1.53	3.56

* Numbers in these columns pertain to the time standard numbers in Table D-IV. A and B refer to removal and replacement times respectively. The number in parentheses refers to the quantity of each action. R/R = removal and replacement.

APPENDIX D

Standard Screws

- This time is for all standard threaded fasteners such as; slotted head, Phillips head, and fillister head
- The time given is the time required to remove/replace the fastener from the hole and disengage/or engage it by several twisting motions of the hand (approximately 8 twists)
- Tool required is standard screwdriver (flat head, Phillips, or hex)

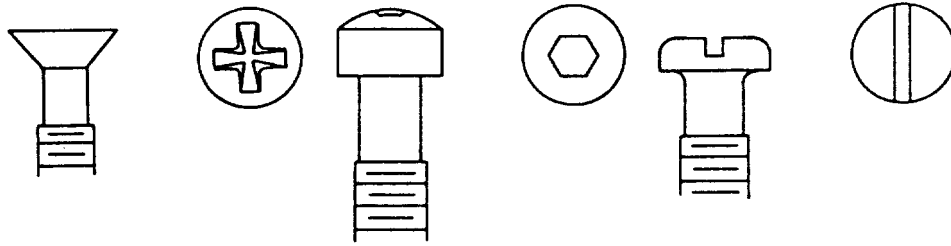

FIGURE D-11. Standard Screws.

Hex or Allen Set Screws

- This time is for hex or Allen type set screws
- The time given is for the time to tighten/or loosen a hexagonal type set screw using an Allen type wrench
- Tools required are hex wrenches or Allen type wrenches

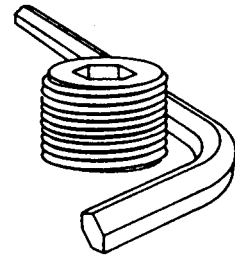

FIGURE D-12. Hex or Allen Set Screws.

Captive Screws

- This time is for standard fasteners that are captive to the panel/bracket they secure
- The time given for this action includes the time to engage/or disengage the fastener by a series of twisting motions with the hand
- The tool required is a standard screwdriver (flathead, Phillips or hex)

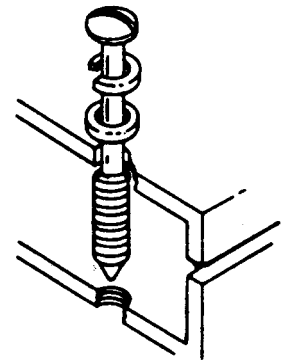

FIGURE D-13. Captive Screws.

APPENDIX D

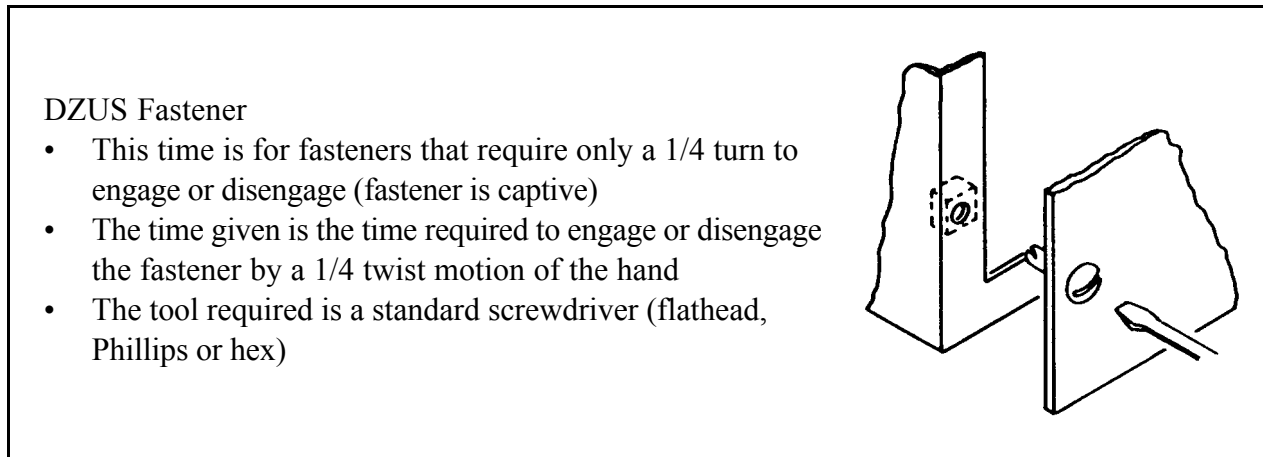

FIGURE D-14. DZUS Fasteners.

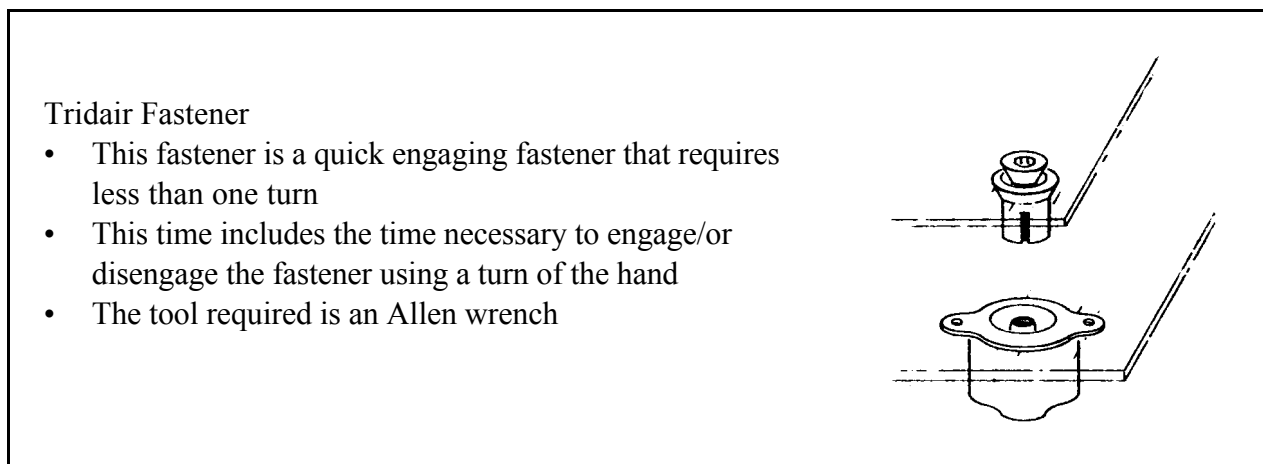

FIGURE D-15. Tridair Fastener.

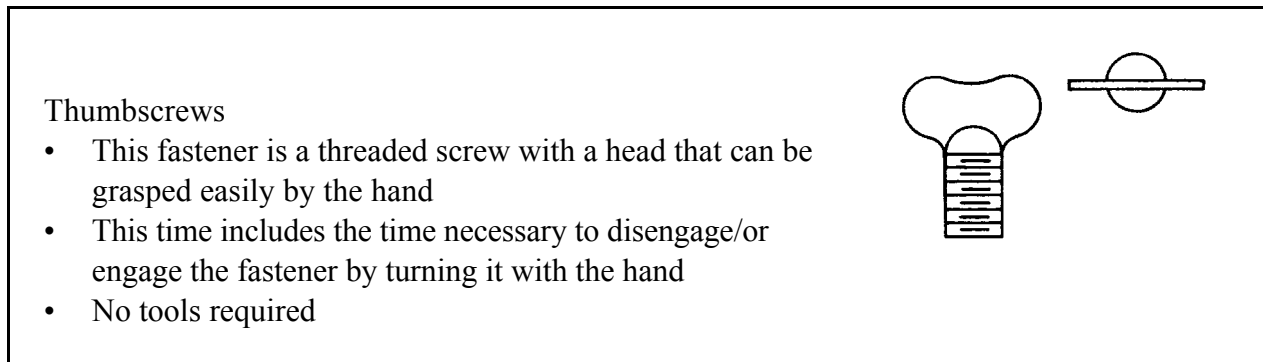

FIGURE D-16. Thumbscrews.

APPENDIX D

Machine Screws (with nut)

- This fastener is any threaded fastener that does not tap into the structure; instead it engages into a loose nut
- This time includes the time to remove/or position the fastener and nut and the time required to tighten the fastener
- Tools required are a screwdriver and a wrench

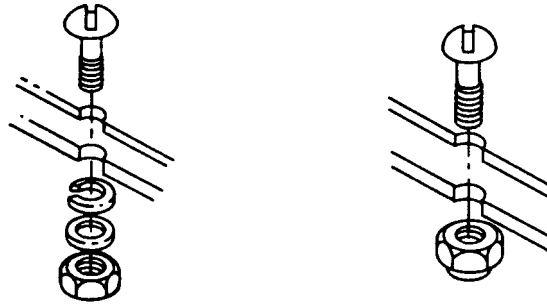

FIGURE D-17. Machine Screws.

Nuts or Bolts

- Any fastener that requires a wrench to tighten it down
- This time includes the time necessary to position the wrench and engage/or disengage the fastener

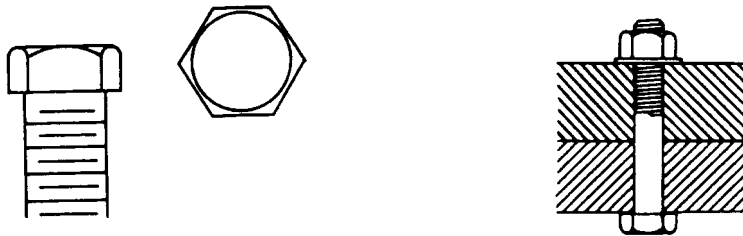

FIGURE D-18. Nuts or Bolts.

APPENDIX D

Retaining Rings

- This device is a "U" shaped piece of metal that retains a unit/component in position
- The time given includes the time necessary to engage/or disengage this fastener
- Special pliers are required to remove/replace this fastener

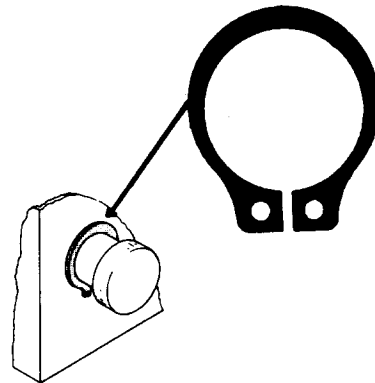

FIGURE D-19. Retaining Rings.

Drawhook Latch

- Any latch that is similar to the one shown here
- The time includes the time to engage/disengage the latch completely
- No tools required

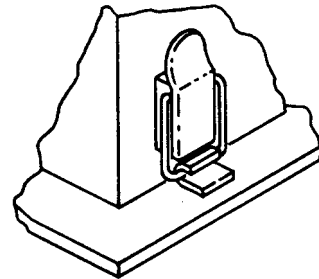

FIGURE D-20. Drawhook Latch.

Spring Clip Catch

- Any latch similar to the one shown here
- Time includes the time necessary to engage/or disengage the latch completely
- No tools required

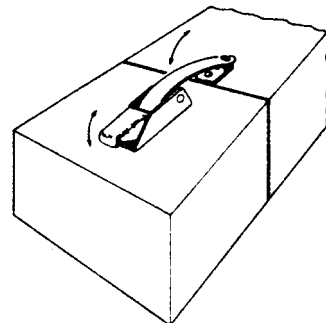

FIGURE D-21. Spring Clip Catch.

APPENDIX D

Butterfly Latch

- Any latch similar to the one shown here
- Time includes the time necessary to engage/or disengage the latch completely. Normally consists of the time to lift the tab and turn it 90°
- No tools required

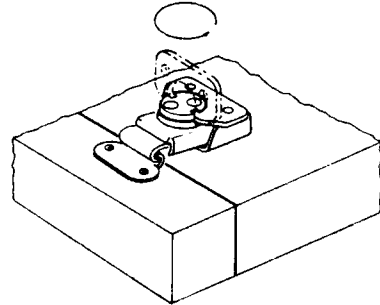

FIGURE D-22. Butterfly Latch.

ATR Latch

- Any latch similar to the one shown here
- Time includes the time necessary to unscrew/or screw the cap over the nib to engage/or disengage the secured unit. The time given is for a pair of ATR latches.
- No tools required

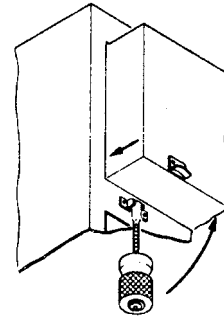

FIGURE D-23. ATR Latch.

Lift and Turn Latch

- Any latch similar to the one shown here
- Time includes the time necessary to lift the handle and turn it to unsecure or secure a door or panel
- No tools required

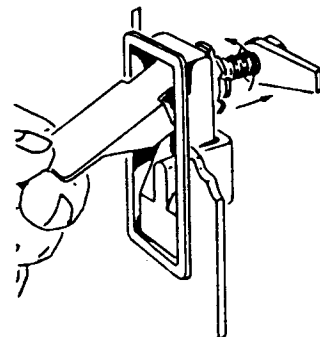

FIGURE D-24. Lift and Turn Latch.

APPENDIX D

Slide Lock Latch

- Any latch similar to the one shown here
- The time given is the time necessary to slide the locking device to engage/or disengage the panel
- No tools required

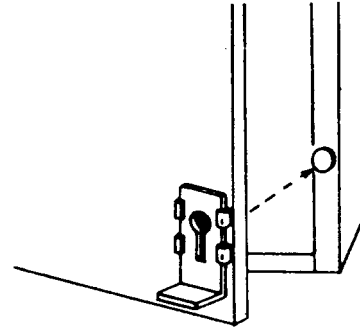

FIGURE D-25. Slide Lock Latch.

Terminal Posts

- Any terminal connection similar to the ones shown here
- This time is the time required to remove or replace a lead from a terminal (does not include soldering or desoldering)
- Needle nose pliers are required for this task

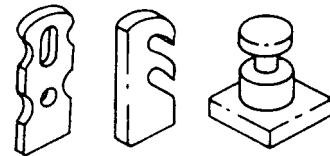

FIGURE D-26. Terminal Post Connections.

Screw Terminals

- Any terminal connection similar to the one shown here
- This time is the time required to remove/or position the terminal lug and loosen/or tighten the screw
- A screwdriver is required

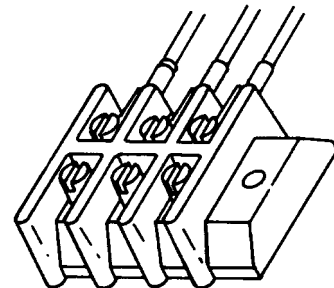

FIGURE D-27. Screw Terminal Connections.

APPENDIX D

Termipoint Connections

- Any terminal connection similar to the one shown here
- This time is the time required to remove the clip with a pick or tweezers and the time to replace the clip with a termipoint gun
- Tools required are tweezers, or a pick, and a termipoint gun

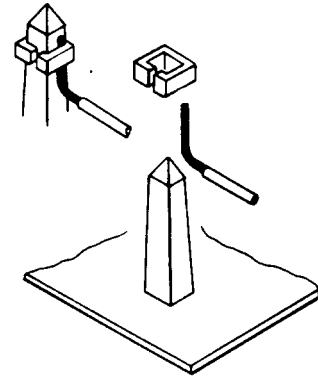

FIGURE D-28. Termipoint Connection.

Wirewrap

- Any terminal connection similar to the one shown here
- The time given are to replace the wirewrap with a wirewrap gun and to remove the connection with an unwrapping tool
- Tools required are a wirewrap gun and an unwrapping tool

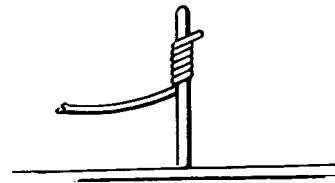

FIGURE D-29. Wirewrap Connection.

Taperpin

- Any terminal connection similar to the one shown here
- The time given is the time required to unplug mate or demate the connector
- No tool required

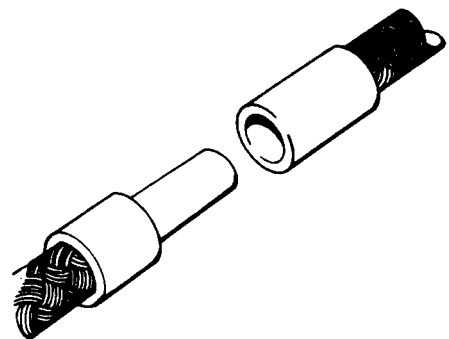

FIGURE D-30. Taperpin Connection.

APPENDIX D

PCB

- Any terminal connected directly to the printed circuitry of a circuit card
- The time given is the time required to remove or replace a lead from the PCB (no soldering or desoldering time included)
- The tools required are a pick or needlenose pliers

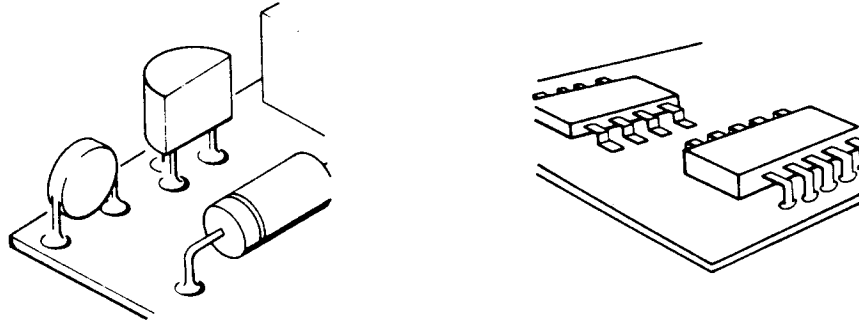

FIGURE D-31. PCB Connections.

BNC Connectors

- Any connector that has a bayonet-locking device
- Times given are for mating/demating the connectors by a twisting motion
- No tool required



FIGURE D-32. BNC Connectors.

Quick Release Coax Connectors

- Any coax connector that engages or disengages by a push or pull motion
- Times given are for demating/mating the connectors by a pulling or pushing motion
- No tool required

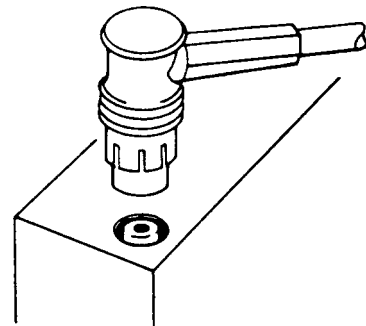

FIGURE D-33. Quick Release Coax Connectors.

APPENDIX D

Friction Locking Connectors

- Any connector that is mated and secured by the friction of the pins and/or connector case
- The time given is the time necessary to mate or demate these connector types
- No tool required

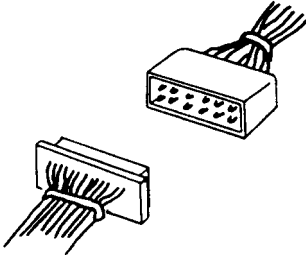

FIGURE D-34. Friction Locking Connector.

Friction Locking Connector with Jackscrew

- Any friction locking connector that is secured by a jackscrew
- The time given is the time necessary to demate/mate the connector by disengaging/engaging the jackscrew
- No tool required

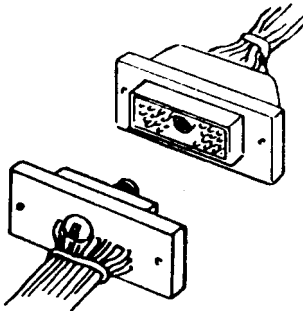

FIGURE D-35. Friction Locking Connector with Jackscrew.

Thread Locking Connector

- Any connector that is secured by a threaded connector shell
- The time given is for the demating/mating of the connector and the securing/unsecuring of it by a turning motion
- No tools required

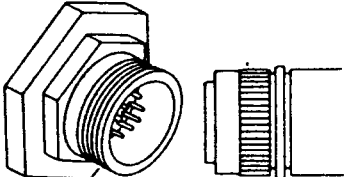

FIGURE D-36. Threadlocking Connector.

APPENDIX D

Slide Locking Connector

- Any connector that is secured by a slide lock
- The time given is the time required to mate/demate the connector and engage/disengage the slide lock
- No tools required

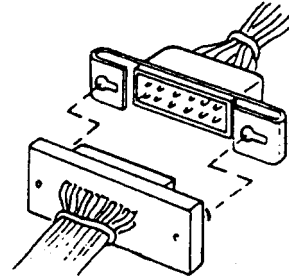

FIGURE D-37. Slide Locking Connector.

DIP ICs

- This includes any dip IC that is secured in a dip socket
- The time given is the time required to unplug or plug in the dip IC
- No tools required

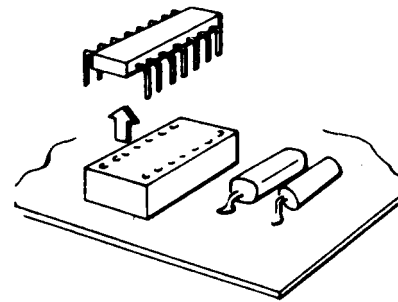

FIGURE D-38. Dip ICs.

Guided CCAs

- Any guided CCA that is inserted/removed by hand
- The time given is the time to pull out or push in the CCA
- No tools required

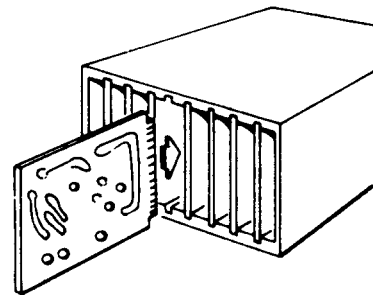

FIGURE D-39. Guided CCAs.

APPENDIX D

Guided CCAs with a Tool

- This time is associated with any CCA that is inserted/removed with a card extracting tool
- The time includes the time required to position the tool and remove/replace the CCA
- A card extracting tool is required

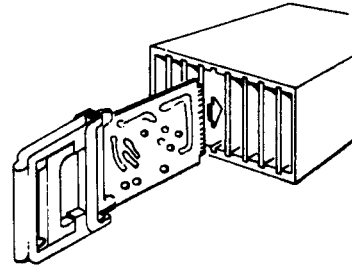

FIGURE D-40. Guided CCAs with a Tool.

Non-guided CCAs

- This time is associated with plug-in cards that are not guided
- The time includes the time required to remove/replace the CCA from the edge connector (does not include time for fasteners)
- No tools required

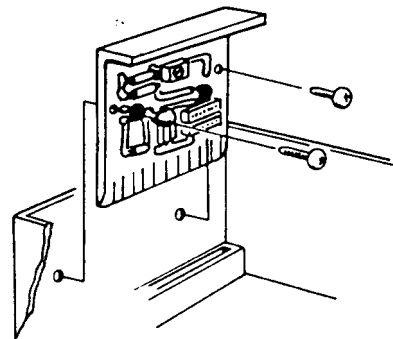

FIGURE D-41. Non-guided CCAs.

Modules

- This is the time associated with removing or positioning a modular assembly
- The time is the time necessary to remove the module or position it in place
- No tools required

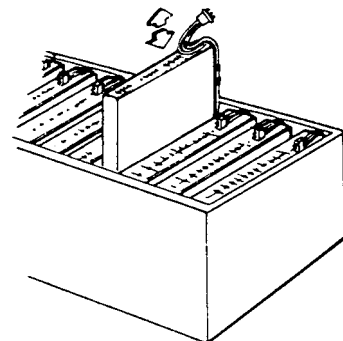
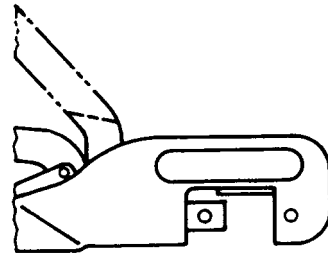

FIGURE D-42. Modules.

APPENDIX D

Crimp Lugs

- This is the time associated with securing a terminal lug to a wire
- The time given includes the time to position the wire in the lug and crimp it
- A crimping tool is required

**FIGURE D-43. Crimp Lugs.****Form Leads**

- This is the time associated with forming a lead on a component prior to connecting it to a terminal
- The time given is the time necessary to grasp the lead with the pliers and form it
- Needle nose pliers are required

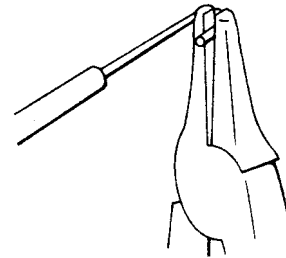
**FIGURE D-44. Form Leads.****Soldering Terminal Posts**

- The time associated with soldering a lead to a terminal post
- The time given is the time to heat the terminal post and apply the solder
- A soldering iron is required

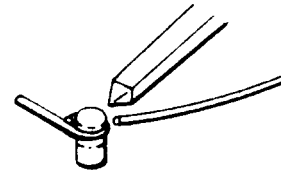
**FIGURE D-45. Soldering Terminal Posts.****Soldering PCB Connections**

- The time associated with soldering a lead to a PCB etching
- The time given is the time to heat the etching pad and apply the solder
- A soldering iron is required

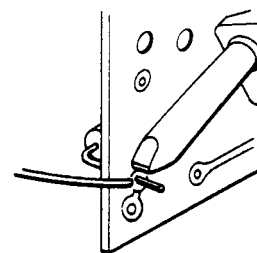
**FIGURE D-46. Soldering PCB Connections.**

APPENDIX D

Desoldering using a Braided Wick

- The time associated with desoldering a connection using a braided copper wick
- The time given is the time to reheat the solder and extract it from the PCB or terminal using a braided copper wick
- A soldering iron and braided copper wick are required

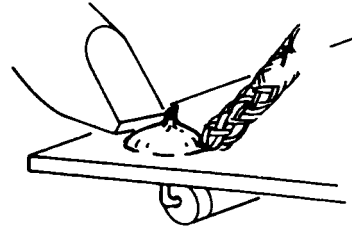

FIGURE D-47. Desoldering with a Braided Wick.

Desoldering using a Vacuum

- The time associated with desoldering a connection using a vacuum assisted desoldering iron
- The time given is the time required to reheat and "suck-up" the solder
- A desoldering iron is required

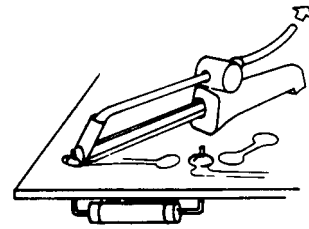

FIGURE D-48. Desoldering Using a Vacuum.

Form Flat Pack Leads

- The time associated with forming flatpack leads using a mechanically operated die
- The time given is the time required to position the flatpack and actuate the mechanism
- A mechanically operated device is used to do this

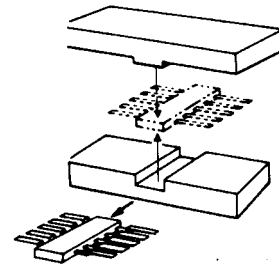

FIGURE D-49. Form Flat Pack Leads.

APPENDIX D

Panels, Doors, and Covers

- The time associated with open/closing panels, doors and covers
- No tools required

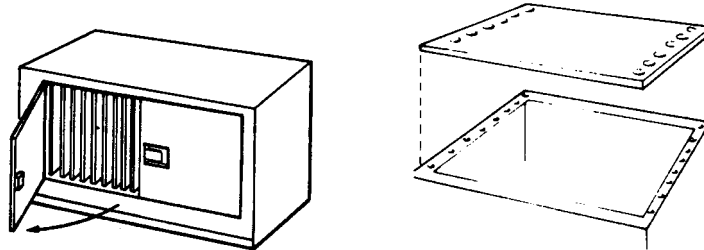

FIGURE D-50. Panels, Doors and Covers.

Drawers

- The time associated with opening/closing of drawers that are on a track
- No tools required

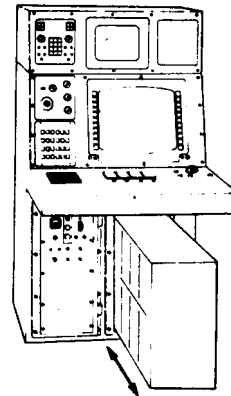

FIGURE D-51. Drawers.

Display Lamps

- The time required to remove/replace panel indicators that pop in and out
- No tools required

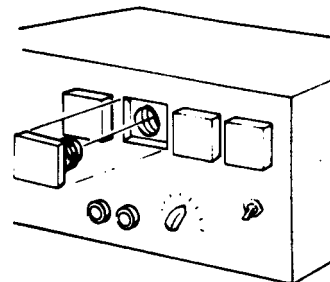

FIGURE D-52. Display Lamps.

APPENDIX D

This page has been left blank intentionally.

APPENDIX E

PHASING OF MAINTAINABILITY ELEMENTS

Scope. This Appendix is an essential part of MIL-HDBK-470A. The information contained herein is intended for reference only. This Appendix is for guidance only and cannot be cited as a requirement. If it is, the contractor does not have to comply.

E.1.0 Product Life Cycle

A product goes through several phases during its life cycle. The number, title, and definitions of the phases vary slightly between the military and commercial communities, and even among commercial companies, but are similar. The life cycle acquisition phases defined by DoD Regulation 5000.2-R are:

- Phase 0 - Concept Exploration
- Phase I - Program Definition and Risk Reduction
- Phase II - Engineering and Manufacturing Development (EMD)
- Phase III - Production, Fielding/Deployment, and Operational Support

DoD 5000.2-R does recognize that it is necessary to demilitarize and dispose of a product¹ at the end of its useful life. Although not designated as an acquisition phase, the period of time over which demilitarization and disposal occurs could be considered the Phase-out and Retirement phase of a product's life cycle.

Each phase has specific objectives and the activities conducted during the phase must support these objectives. Milestone decision points mark the beginning and end of the acquisition phases. The milestone decision points are:

- Milestone 0 - Approval to Conduct Concept Studies (beginning of phase 0)
- Milestone I - Approval to Begin a New Acquisition Program (end of Phase 0, beginning of Phase I)
- Milestone II - Approval to Enter EMD (end of Phase I, beginning of Phase II)
- Milestone III - Production or Deployment Approval (end of Phase II, beginning of Phase III)

For some products, a phase may be "abbreviated" or even "skipped." For example, the R&D phase for a new product that is simply an updated or moderately improved version of an older, mature product will likely be very short, concentrating only on the differences between the two.

¹ DoD Directive 5000.1 and DoD Regulation 5000.2-R use the term "system", not product. Recall, however, that within this handbook, the general term "product" will be used to mean system, equipment, or item. It could be a vehicle, a transmission, or an engine, whatever is being developed under the acquisition program.

APPENDIX E

Figure E-1 shows the life cycle phases, milestone decision points, the objectives of each phase, and a summary of the activities associated with each phase.

ACQUISITION PHASES				
	0 Concept Exploration	I Program Definition and Risk Reduction	II Engineering and Manufacturing Development	III Production, Fielding/Deployment, and Operational Support
O b j e c t i v e s	<ol style="list-style-type: none"> 1. Define and evaluate the feasibility of alternative concepts to meet deficiencies 2. Provide the basis for assessing relative merits of alternative concepts at next decision milestone 	<ol style="list-style-type: none"> 1. Define program as one or more concepts 2. Pursue design approaches and parallel technologies 	<ol style="list-style-type: none"> 1. Translate most promising design approach into stable, producible, supportable, and cost effective design 2. Validate manufacturing and production processes 3. Demonstrate product capabilities through testing 	<ol style="list-style-type: none"> 1. Produce and manufacture the product 2. Deploy the product 3. Operate and maintain the product
K e y A c t i v i t i e s	<ol style="list-style-type: none"> 1. Validate assessment of need 2. Conduct concept studies 3. Develop product requirements in terms of effectiveness and performance measures 	<ol style="list-style-type: none"> 1. Conduct prototyping, demonstrations, and early operational assessments to reduce risk 2. Update product requirements 3. Identify accomplishments to be completed in Phase 2 	<ol style="list-style-type: none"> 1. Achieve design stability 2. Verify adequate resources have been programmed for production, deployment, and support 3. Conduct IOT&E 	<p>Manufacturing Use of the product in the intended environment, scheduled and unscheduled maintenance, improvements through updates and modifications, performance tracking</p>
	▲ Milestone 0 Decision Point	▲ Milestone I Decision Point	▲ Milestone II Decision Point	▲ Milestone III Decision Point
MILESTONE DECISION POINTS				

FIGURE E-1. Life Cycle Phases of a Product.

The product will be kept in service, sometimes beyond the original intended service life through life extension efforts. Eventually, it will be necessary to retire and dispose of the product. Removal of a product from service can entail the disposal of toxic materials, recovery of precious metals, and recycling.

APPENDIX E

E.2.0 Maintainability Activities by Life Cycle Phase.

The maintainability activities conducted during each of the life cycle phases of a product must be consistent with and support the overall objectives for the phases. In the following discussion, maintainability activities will be discussed in the context of the phase(s) in which they are most applicable. It is not practical to try and address all possible types of products, so the discussion assumes that a major product, such as an aircraft, tank, turbine engine, or similar item, is being developed. It should be obvious that the level of effort and types and scope of activities that would be necessary for a portable, man-carried receiver/transmitter will not be the same as for a new tactical fighter or main battle tank. Figure E-2 summarizes the discussion.

E.2.1 Phase 0 - Concept Exploration. During the concept exploration phase, the maintainability activities are necessarily intended to prepare for Phase I. The maintainability program plan may be started in which the goals and objectives for the new product are broadly stated. Some analysis may be made of prior similar products to help establish ranges of realistic maintainability goals. Very general modeling may be used to complement the analysis in deriving ranges of maintainability goals. Also, new approaches and technologies related to maintainability design, analysis, and validation can be identified during this phase.

E.2.2 Phase I - Program Definition and Risk Reduction. For the alternative concepts that are carried into this phase, the maintainability effort becomes more intense and focused. Additional detail is added to the maintainability program plan. Additional analysis is required to begin developing better defined maintainability requirements for the next phase of acquisition. Maintainability engineers should be participating in and supporting trade studies in which the various alternatives are compared, different design approaches are evaluated, and overall system requirements are harmonized². Some program and design reviews are usually held during this phase, and the issue of maintainability must be considered during these reviews. The emphasis during these early reviews will be to choose among the alternative concepts. An understanding of the strengths and weaknesses of the alternatives, from a maintainability perspective, must be one result of these reviews. Preliminary modeling, high-level maintainability block diagrams of the various maintenance concepts for each design concept may be needed. In addition, the maintainability concept must be evaluated to ensure that the necessary and proper general design attributes are assigned to each product element. Data from whatever prototyping, proof-of-concept demonstrations, and similar "testing" is conducted should be analyzed in evaluating the relative maintainability of each concept and in determining realistic maintainability characteristics for the product.

² As used here, harmonization refers to developing a set of consistent, non-conflicting requirements for the product. Compromises and trade-offs are made to ensure that the overall performance (including maintainability) of the product is optimized, rather than any single requirement. Of course, the various requirements may be prioritized and the resulting harmonized set of requirements must reflect this prioritization. Finally, the goal of a totally harmonized set of requirements is elusive and the effort continues during Phase 3 as unexpected problems are revealed, especially during test.

APPENDIX E

Key Maintainability Activities	ACQUISITION PHASES			
	0 Concept Exploration	I Program Definition and Risk Reduction	II Engineering and Manufacturing Development	III Production, Fielding/Deployment, and Operational Support
Program Plan	S	G (2)	G	G (2) (1)
Supplier Control		S	G	G (Prod), S (Opnl)
Program & Design Reviews	S	G (2)	G	G (Prod), S (Opnl)
Design		S (2)	G	C (Prod), S (Opnl)
Analysis	S (2)	G (2)	G (1)	C (1) (Prod), S (Opnl)
Modeling	S	S (3)	G	C (Prod), S (3)
Test & Demo		S	G	C (Prod), S (Opnl)
Data Collection, Analysis & Corrective Action		S	G	G (Prod), S (Opnl)
	Milestone 0	Milestone I	Milestone II	Milestone III

MILESTONES

Definition of Codes:

- S - Selectively applicable
- G - Generally applicable
- C - Generally applicable to design changes only
- Prod - Production
- Opnl - Operational Support
- (1) - Requires considerable interpretation of intent to be cost effective
- (2) - Appropriate for those task elements suitable to defining during this phase
- (3) - Depends on physical complexity of the product, its packaging, and overall maintenance concept.

FIGURE E-2. Application of Activities by Phase.

APPENDIX E

E.2.3 Phase II - Engineering and Manufacturing Development. Usually only one concept is carried into Phase II. As indicated in Figure E-1, the objectives of this phase are to:

- translate the most promising design approach into a stable, producible, supportable, and cost effective design
- validate the manufacturing and production processes to be implemented in Phase III
- demonstrate product capabilities through testing

During this phase, the design of the product is matured. The processes that will be used to manufacture and produce the product are developed. Development test and evaluation (DT&E) and some initial operational test and evaluation (IOT&E) is conducted to verify the design and demonstrate the product's performance. Consequently, it is during this phase that the maintainability effort is most intense. The maintainability program plan must clearly define:

- the activities (tasks) to be conducted during this phase
- the purpose and expected result of each activity
- who will perform each activity
- when each activity must be performed
- the resources required for the activities

General and specific design criteria, standards, and policies for maintainability are defined and implemented. Requirements for suppliers are developed based on allocations of product-level maintainability requirements. Maintainability analyses are conducted to evaluate the evolving design, identify problems, and develop solutions to those problems. Modeling and simulation are used as part of the evaluation effort. Predictions and estimates of maintainability are made, first using only analytical inputs. As testing and demonstrations occur, data from these events are collected and analyzed to refine the estimates of the design maintainability. Based on the design maintainability and the results of any IOT&E, assessments can be made of the operational maintainability of the product. The effectiveness of diagnostics, especially built-in test, accessibility for maintenance, the adequacy of the man-machine interface, and other issues are addressed. Support and training equipment requirements, and maintenance training requirements must be identified as well as support facilities. Maintainability engineers are concerned with the development of maintenance procedures, determining sparing requirements, and in developing the needed inputs to the detailed maintenance plan and logistics support analysis. Data collection, analysis, and corrective action is an essential activity during this phase because it supports the analysis, design, and evaluation efforts.

E.2.4 Phase III - Production, Fielding/Deployment, and Operational Support. During production, the focus of the maintainability effort will be to ensure that the designed level of

APPENDIX E

maintainability is not compromised by any proposed engineering changes. Additional operational testing and demonstration will occur during production and deployment, and the maintainability engineer must be involved with these efforts to refine and update the assessment of the product's operational maintainability. The maintainability program plan may be updated to better define the activities to be conducted during production, deployment, and operational support. Supplier control will continue during production and may continue into the operational support phase. During the operational support portion of this phase, efforts must continue to track and evaluate proposed design changes (due to modifications and upgrades), track and evaluate the operational maintainability of the product, identify problems (ideally before they occur), and develop solutions for these problems. Maintainability design, analysis, and test will be required to support modifications, whether those modifications are made to address maintainability or for any other reason (e.g., safety, upgrade functional performance, extend life, etc.).

E.2.5 Demilitarization and Disposal. When some military products reach the end of their useful life, they may need to be demilitarized prior to disposal. It will be necessary to dispose of all "discarded" product. Disposal may involve component and material reclamation and disposal. To some extent, the maintainability engineer can address disposal and reclamation by considering material durability, environmental concerns, statutory regulations governing material disposal, and the methods and locations where reclamation and disposal might be performed during design. Special attention should be paid to the reclamation of precious metals and the disposal of hazardous or radioactive materials. During disposal, Lessons Learned files are updated, and in-depth tear-down analyses are often conducted of selected components to update service life data.

APPENDIX F

MAINTAINABILITY REFERENCES

F.1.0 Scope. This Appendix is an essential part of MIL-HDBK-470A. The information contained herein is intended for reference only. This appendix identifies both the Government and non-government documents from which material and ideas, dealing specifically with maintainability, were considered for incorporation in this handbook update. Applicable document sources include: DoD: directives, standards, handbooks, guide documents and laboratory reports; ANSI and member professional societies including the SAE and IEEE; IEC; NATO; and other published literature.

Those documents marked with an asterisk (*) are being or have been canceled by the government when this handbook was published. However, since many companies may have copies and may wish to use them as references, they are listed here. Those marked with a double asterisk (**) are being converted or have been converted to military handbooks, data specs, design criteria standards, or standard practices.

This Appendix is for guidance only and cannot be cited as a requirement. If it is, the contractor does not have to comply.

F.2.0 US Government documents. Copies of current US Government documents are available from: Standardization Document Order Desk, 700 Robbins Avenue, Building 4D, Philadelphia, PA 19111-5094.

2.1 Department Of Defense Directives and Instructions

DOD 4120.3	Defense Standardization Program Policies and Procedures
DOD 5000.1	Defense Acquisition
DOD 5000.2-R	Mandatory Procedures for Major Defense Acquisition Programs (MDAPs) and Major Automated Information System Acquisition Programs (MAISAPs)
*DOD 5000.39	Acquisition and Management of ILS for Systems and Equipment
*DOD 5000.40	Reliability and Maintainability

F.2.2 Department Of Defense Standards

MIL-STD-280	Definitions of Item Levels, Item Exchangeability, Models and Related Terms
*MIL-STD-721	Definition of Terms for Reliability and Maintainability

MIL-HDBK-470A

APPENDIX F

DOD-STD-863	Military Standard Wiring Data and Schematic Diagrams, Preparation of
MIL-STD-962	Defense Standards and Handbooks
MIL-STD-1309	Definition of Terms for Testing, Measurement, and Diagnostics
*MIL-STD-1369	Integrated Logistic Support Program Requirements
**MIL-STD-1388-1	Logistics Support Analysis
**MIL-STD-1388-2	DOD Requirements for a Logistics Support Analysis Record
**MIL-STD-1472	Human Engineering Design Criteria for Military Systems, Equipment and Facilities
*MIL-STD-1568	Materials and Processes for Corrosion Prevention and Control in Aerospace Weapons Systems
*MIL-STD-1629	Procedures for Performing an FMECA
MIL-STD-1686	Electrostatic Discharge Control Program for Protection of Electronic Parts, Assemblies and Equipment
DOD-STD-1701	Hardware Diagnostic Test System Requirements
MIL-STD-1761	Fastener Recess Test, Method for Damage Tolerance Evaluation
MIL-STD-1814	Integrated Diagnostics
MIL-STD-2067	Aircrew Automated Escape Systems R&M Program, Requirements for
MIL-STD-2073-1	DOD Standard Practice for Military Packaging
*DOD-STD-2107	Product Assurance Program Requirements for Contractors
MIL-STD-2155	Failure Reporting, Analysis and Corrective Action System
MIL-STD-2173	Reliability-Centered Maintenance Requirements for Naval Aircraft, Weapons Systems and Support Equipment

F.2.3 Department Of Defense Handbooks

MIL-HDBK-217	Reliability Prediction of Electronic Equipment
MIL-HDBK-263	Electrostatic Discharge Control Handbook for Protection of Electrical and Electronic Parts, Assemblies and Equipment
MIL-HDBK-338	Electronic Reliability Design Handbook
MIL-HDBK-454	Standard General Guidelines for Electronic Equipment
MIL-HDBK-470	Maintainability Program for Systems and Equipment
*MIL-HDBK-471	Maintainability Verification / Demonstration/ Evaluation
MIL-HDBK-472	Maintainability Prediction
MIL-HDBK-759	Human Engineering Design for Military Materiel

APPENDIX F

DOD-HDBK-791	Maintainability Design Techniques
MIL-HDBK-792	Prove Out of Production Facilities
MIL-HDBK-798	System Engineer's Design for Discard Handbook
MIL-HDBK-1472	Human Engineering Design Criteria for Military Systems, Equipment and Facilities
MIL-HDBK-2084	General Guidelines for Maintainability of Avionics and Electronic System and Equipment
MIL-HDBK-2165	Testability Program for Systems and Equipment
*MIL-HDBK-46855	Human Engineering Guidelines for Military Systems, Equipment, and Facilities

F.2.4 Department Of Defense Guide Documents

AF GUIDE SPEC. 87256 Integrated Diagnostics

F.2.5 Rome Laboratory Reports. Copies of the following Rome Laboratory documents are available from: the Defense Technical Information Center (DTIC-FDAC), Cameron Station, Building 5, Alexandria, VA 22304-6145, Tel (703) 274-7633 or from the National Technical Information Service (NTIS), Department of Commerce, 5285 Port Royal Road, Springfield, VA 22161-2171, Tel (703) 487-4650.

RL-TR-95-289	Fault Logging Using a Micro Time Stress Device
RL-TR-94-196	Micro-Time Stress Measurement Device Development
RL-TR-94-232	Reliability And Maintainability Design Expert System
RL-TR-93-209	A Quality Process Approach to Electronic Systems Reliability: (Two volumes)Handbook Procedure
RL-TR-92-12	Testability Design Rating System: Testability Handbook (Vol I) 2 Vols and Analytical Procedure (Vol II)
RL-TR-91-6	Digital Logic Testing and Testability, In-House Report
RADC-TR-90-31	A Contractors Program Manager's Testability / Diagnostics Guide
RADC-TR-89-209	Computer-Aided Design for Built-In Test
RADC-TR-89-230	Fault Simulation Evaluation
RADC-TR-78-169	Maintainability Prediction and Analysis Study
RADC-TR-70-89	Maintainability Prediction and Demonstration Techniques (Final Report)
RADC-TR-69-356	Maintainability Prediction and Demonstration Techniques (2 Volumes)

APPENDIX F

F.2.6 Air Force Documents. Copies of the following document are no longer available.

*DH 1-9 AFSC Design Handbook, Series 1-0 General - Maintainability

F.2.7 US Army Documents. Copies of the following documents are no longer available.

QR-870-J Maintainability Program for Systems and Equipment Development

AMCP 706-133 Engineering Design Handbook: Maintainability engineering Theory and Practice

F.2.8 US Navy Documents. Copies of the following documents are no longer available.

*NAVAIR 01-1A-31 Reliability and Maintainability Management Handbook

*NAVAIR 01-1A-33 Maintainability Engineering Handbook

F.2.9 National Aeronautical And Space Administration (NASA) Documents. Copies of current NASA documents are available from: NASA Center for Aerospace Information, 800 Elkridge Landing Rd., Linthicum Heights, MD 21090-2934, Tel, (301) 621-0134, Fax, (301) 621-0100.

NASA NHB 5300.4 (1G) Reliability, Maintainability, and Quality Assurance Publication, NASA Assurance Terms and Definitions

NASA NHB 5300.4 (1E) Reliability, Maintainability, and Quality Assurance Publication, Maintainability Program Requirements for Space System

F.3.0 Non-Government Publications.

F.3.1 International Electrotechnical Commission (IEC) Documents. Copies of IEC documents are available from: American National Standards Institute, 1430 Broadway, New York, NY 10018, Telephone, (212) 642-4900, FAX, (212) 302-1286.

IEC 50 Chap 191 International Electrotechnical Vocabulary Chapter 191: Dependability and Quality of Service

IEC 300 - 3-2 Dependability Management - Part 3: Application Guide - Section 2: Collection of Dependability Data from the Field

IEC 362 Guide for the Collection of Reliability, Availability, and Maintainability Data from Field Performance of Electronic Items

IEC 706 - 1 Guide on Maintainability of Equipment - Part 1: Sections One, Two and Three: Introduction, Requirements and Maintainability Programme

APPENDIX F

IEC 706 - 2	Guide on Maintainability of Equipment - Part 2: Section Five: Maintainability Studies During the Design Phase
IEC 706 - 3	Guide on Maintainability of Equipment - Part 3: Sections Six and Seven: Verification and Collection, Analysis and Presentation of Data
IEC 706 - 4	Guide on Maintainability of Equipment - Part 4: Section 8: Maintenance and Maintenance Support Planning
IEC 706 - 5	Guide on Maintainability of Equipment - Part 5: Section 4: Diagnostic Testing
IEC-812	Analysis Techniques for System Reliability - Procedure for Failure Mode and Effects Analysis (FMEA)
IEC 706 - 6	Guide on Maintainability of Equipment - Part 6: Section 9: Statistical Methods in Maintainability Evaluation
IEC 812	Analysis Techniques for System Reliability - Procedure for Failure Mode and Effects Analysis
IEC 863	Presentation Of Reliability, Maintainability and Availability Predictions

F.3.2 American National Standards Institute (ANSI) Documents. Copies of ANSI documents are available from: American National Standards Institute, 1430 Broadway, New York, NY 10018, Telephone, (212) 642-4900, FAX, (212) 302-1286.

ANSI/IEEE 762	Standard Definitions for Use in Reporting Electric Generating Unit Reliability, Availability, and Productivity
ANSI/SAE AIR 4276	Survey Results: Computerization of Reliability, Maintainability and Supportability (RM&S) in Design

F.3.3 Society Of Automotive Engineers (SAE) Documents. Copies of SAE documents are available from: SAE International, Publications Sales, 400 Commonwealth Drive, Warrendale, PA 15096-0001, Telephone, (412) 776-4970, FAX, (412) 776-5760.

SAE ARD 50010	Recommended RMS Terms And Parameters
SAE ARD 50046	RMS Information Sourcebook
SAE M-102	Reliability, Maintainability, and Supportability Guidebook
SAE J 1739	Potential Failure Mode And Effects Analysis in Design (Design FMEA) and Failure Mode And Effects Analysis in Manufacturing and Assembly Processes (Process FMEA) Reference Manual, Recommended Practice
SAE HS-2600	SAE Maintainability, Repairability, and Serviceability Standards Manual

APPENDIX F

F.3.4 Automotive Industries Action Group (AIAG) Documents. Copies of the following AIAG document are available from: Automotive Industry Action Group, 26200 Lahser Road, Suite 200, Southfield, MI 48034, Telephone (313) 358-3003.

(No number) Potential Failure Mode and Effects Analysis (FMEA).

F.3.5 Institute of Electrical and Electronics Engineers (IEEE) Documents. Copies of IEEE document are available from: IEEE, 445 Hoes Lane, P.O. Box 1331, Piscataway, NJ 08855-1331, Telephone, (800) 678-IEEE, FAX, (908) 981-9667.

IEEE-STD-1149.1 Standard Test Access Port and Boundary-Scan Architecture

F.3.6 Air Transport Association Documents. Copies of ATA document are available from: Air Transport Association of America, P.O. Box 511, Annapolis Junction, MD 20701, Telephone, (202) 626-4000.

ATA-Spec. 2100 Digital Data Standards for Aircraft Support

F.3.7 North Atlantic Treaty Organization (NATO) Documents. Copies of NATO documents are available from: Global Engineering, 15 Inverness Way East, Englewood CO 80112-5704, Telephone, (800) 854-7179, FAX, (303) 792-2192.

NATO ARMP-1 Ed 2 NATO Requirements for Reliability and Maintainability

NATO ARMP-2 Ed 2 General Application Guide on the Use of ARMP-1

NATO ARMP-3 Application of National Reliability And Maintainability Documents

NATO ARMP-5 Guidance on Reliability and Maintainability Training

NATO ARMP-6 In-Service Reliability and Maintainability

NATO ARMP-8 Ed 1 Reliability And Maintainability in the Procurement of Off-the-Shelf Equipment

F.4.0 Published Literature.

F.4.1 Reliability And Maintainability Symposium Proceedings (RAMS)

Bakken, D., and J. M. Banghart, "More Accurate Maintainability Predictions," 1985 RMS Page 44

Downs, W. R., "Maintainability Analysis versus Maintenance Analysis - Interfaces and Discrimination," 1976 RMS Page 476

APPENDIX F

Locks, M. O., "Maintainability and Life-Cycle Costing," 1978 RMS Page 251

Rawicz, A. H. and D. R. Girling, "Neural-Network Enhancement for a Reliability Expert-System", 1994 RMS.

Vannatter, R. L., "New Maintainability Prediction Technique," 1985 RMS Page 39

F.4.2 AUTOTESTCON Proceedings

Debany, W.H., D.E. Daskiewich and C.R. Unkle, "Integrating Logic Simulation And Dependency Modeling," *AUTOTESTCON*, 1993.

DeMare, G. and G. Giordano, "Intelligent Maintenance Aid "Software," *AUTOTESTCON*, 1994.

Franco, J.R., "Experiences Gained Using the Navy's IDSS Weapon System Testability Analyzer," *AUTOTESTCON*, 1988.

Su, L.P. Dr., G. de Mare, and M. Nolan, "*DARTS: An Enabling Technology for Concurrent Engineering*," *AUTOTESTCON*, 1993

F.4.3 Other Symposia

Johnson, F. and R. Unkle, "The System Testability and Maintenance Program (STAMP[®]), A Testability Assessment Tool For Aerospace Systems," AIAA/NASA Symposium on Maintainability of Aerospace Systems, 1989.

Saporito, J. and C.R. Unkle, "An Approach to Bed-Of-Nails Testing Using Dependency Modeling Techniques," *Proceedings, Symposium On the Role of Reliability, Availability, and Maintainability in Providing Quality Army Equipment*, June 1992.

F.4.4 Journals

SAE Communications in RMS, Knezevic, J., "Maintainability Prediction at the Design Level," Vol. 1, No. 1, Winter 1994.

F.4.5 Corporate Documents

"Maintainability Handbook: A Guide for Maintainability Engineers," McDonnell Douglas Corp. B1399, 27 February 1989.

APPENDIX F

F.4.6 Published Textbooks and Dictionaries

"Bodyspace: Anthropometry, Ergonomics, and Design," S. Pheasant, Taylor and Francis, Inc., Philadelphia, PA, 1986.

"Human Engineering Guide to Equipment Design," H. P. Van Cott and R. C. Kinkade, Revised Edition of 1963 Text Published by the U.S. Government Printing Office, Tams Books, Inc., Los Angeles, CA, 1972.

"Human Factors Design Guide," W. E. Woodson, McGraw-Hill, New York, NY 1981.

"The Human Factor in Engineering," J.H. Burgess, Petrocelli Books, Princeton, NJ, 1986.

"Human Factors in Engineering and Design," E. J. McCormick, McGraw-Hill, Inc., New York, NY, 1976.

"Product Assurance Dictionary," Dr. R. R. Landers, Marlton Publishers, Marlton, NJ, 1996.

"Reliability Centered Maintenance," A. M. Smith, McGraw-Hill, Inc., New York, NY, 1993.

"Systems Engineering and Analysis," B. S. Blanchard and W. J. Fabrycky, Prentice-Hall, Inc., Englewood Cliffs, NJ, 1981.

F.4.7 Maintainability Software Tools. Many maintainability software tools are available from government, industry and academia. Table F-I is a list of software tool types with associated supplier reference numbers. Table F-II is the list of the suppliers associated with the reference numbers. While the list of suppliers may not be complete, it includes addresses and telephone numbers confirmed to be accurate as of March 1995. The inclusion of a supplier does not in any way constitute Government endorsement nor does the omission of a supplier constitute Government disapproval. Potential software tool users should thoroughly research any claims made by software suppliers and carefully study their own needs before obtaining any software. Further information on maintainability software tools can be obtained in the following reports (the reports contain data relative to software tool hardware requirements, claimed capabilities, interface capabilities, demonstration package availability and price):

RL-TR-91-87 "A Survey of Reliability, Maintainability, Supportability and Testability Software Tools"

RMST 93 "R&M Software Tools," Reliability Analysis Center

Also see "<http://rome.iitri.com/RAC/TECHNICAL/RMST>", the RAC R&M Software Tools Listing on the Internet World Wide Web.

APPENDIX F

TABLE F-I: Software Tool Type/Supplier Reference Number Listing.

Software Tool Type	Supplier Reference Numbers
FMECA/FMEA	2,6,8,9,10,12,13,14,15,18,19,20,21,24,25
Maintainability Prediction & Analysis	2,3,4,7,9,13,14,15,17,20,21,22,23,24
Testability	26,27,28,29
Reliability Centered Maintenance	14
Repair Level Analysis	1
Logistics	2,14,15,22
Availability	4,5,11,14,15,16,22

TABLE F-II: R&M Software Tool Supplier Listing.

1. Air Force Materiel Command Logistics Model Development Branch ASC/ALTD Wright-Patterson AFB, OH 45433 (513) 255-2122	9. Innovative Software Designs, Inc. One Country Drive Greensburg, PA 15601 (412)836-8800 FAX: (412) 836-8844
2. Advanced Logistics Developments (IQRC) P. O. Box 232 College Point, NY 11356 (212) 594-6600	10. Innovative Timely Solutions 7413 Six Forks Road, Suite 113 Raleigh, NC 27615 (919) 846-7705 FAX: (919) 676-1282 E-mail: qed@nando.net
3. BQR Reliability Engineering Ltd. P.O. Box 208 Rishon-LeZion 75101 Israel 972-3 966-3569 FAX: 972-3 969-8459	11. Isograph Ltd. Television House 10 Mount St. Manchester M25WT United Kingdom +44 (0) 161-835-2902
4. COSMIC, University of Georgia 382 East Broad St. Athens, GA 30602 (404) 542-3265	12. JBF Associates 1000 Technology Park Center Knoxville, TN 37932-3353 (615) 966-5232 FAX: (615) 966-5287
5. Decision Systems Associates 746 Crompton Rd. Redwood, CA 94061 (415) 369-0501	13. JORI Corp. Attn: John House 4619 Fontana St. Orlando, FL 32807 (407) 658-8337
6. Engineered Work Systems, Inc. 145 S. Livernois, Suite 112 Rochester, MI 48307 (313) 651-4211	14. Management Sciences, Inc. 6022 Constitution Ave. NE Albuquerque, NM 87110 (505) 255-8611 FAX: (505) 268-6696 E-mail: marketing@mgtsciences.com
7. Evaluation Software 2310 Claassen Ranch Lane Paso Robles, CA 93446 (805) 239-4516 FAX: (805) 239-9046	15. Mitchell & Gothier 200 Baker Ave. Concord, MA 01742 (508) 369-5115
8. Ford Motor Company FMEA Program Headquarters 101 Union Street Plymouth, MI 48170 (313) 455-0055 FAX: (313) 459-6861 E-mail: fmea@quality.ta.ford.com	16. National Energy Software Center 9700 S. Cass Ave. Argon, IL 60439 (708) 972-7250

APPENDIX F

TABLE F-II: R&M Software Tool Supplier Listing (continued).

17. National Technical Information Service 5258 Port Royal Rd. Springfield, VA 22161 (703) 487-4763	24. Tecnasa Electronica Professional S.A. Av. Brig. Faria Lima 811, Cx Postal 201 Sao Jose dos Campos SP CEP12.225 Brazil 55-123-41-3344
18. OMEGA Logistics 2700 Navajo Road, Suite A, El Cajon, CA 92020 (619) 697-1238	25. Turing Institute Ltd. North American Office 68 Smith St. Chelmsford, MA 01824-1711 (508) 256-9593
19. OMNEX Engineering and Management 777 E. Eisenhower Parkway, Suite 315 Ann Arbor, MI 48108 (313)761-4940 FAX: (313) 761-4966	26. DETEX Systems, Inc. Attn: Craig De Paul (for STAT™) 1574 N. Batavia Suite 4 Orange, CA 92667 (714) 637-9325 FAX: (714) 998-4875
20. Powertronic Systems, Inc. 13700 Chef Menteur Hwy. New Orleans, LA 70129 (504)254-0383 FAX: (504) 254-0393	27. ARINC Attn: John Sheppard (for STAMP™) 2551 Riva Road Annapolis, MD 21401 (410) 266-4000
21. Probabilistic Software, Inc. PSI Building, Suite 101 4536 Indianola, P.O. Box 714 La Canada, CA 91011 (818) 790-9743	28. Naval Undersea Warfare Center Attn: Tim Bearse (for WSTA) Newport Division 1176 Howell Street Newport, RI 02841-1708
22. Rex Thompson & Partners, Ltd. Newnhams, West St. Farnham, Surrey GU9 7EQ England 0252-711414	29. Giordana Automation Corporation Attn: Gerard Giordana (for Diagnostician™) Sparta, NJ 07871
23. SEA (Systems Effectiveness Associates, Inc.) 20 Vernon St. Norwood, MA 02062 (617) 762-9252	

APPENDIX G

MAINTAINABILITY GLOSSARY OF TERMS, DEFINITIONS, ACRONYMS AND ABBREVIATIONS

SCOPE

This Appendix is an essential part of MIL-HDBK-470A. The information contained herein is intended for reference only. Many definitions, acronyms, and abbreviations are used in the field of maintainability, and no attempt has been made to list them all here. Instead, a compilation of terms from three historical documents (MIL-STD-721, MIL-HDBK-470, and MIL-HDBK-471) and from MIL-HDBK-472, and key terms from this handbook is provided.

This Appendix is for guidance only and cannot be cited as a requirement. If it is, the contractor does not have to comply.

-A-

ACCESSIBILITY: A measure of the relative ease of admission to the various areas of an item for the purpose of operation or maintenance.

ACTIVE CORRECTIVE MAINTENANCE TIME: That part of active maintenance time during which actions of corrective maintenance are performed on an item. Excluded are logistics and administrative delays (e.g., awaiting parts, shift change, etc.).

ACTIVE TIME: That time during which an item is in an operational inventory.

ADMINISTRATIVE TIME: That element of delay time, not included in the supply delay time.

AFFORDABILITY: Affordability is a measure of how well customers can afford to purchase, operate, and maintain a product over its planned service life. Affordability is a function of product value and product costs. It is the result of a balanced design in which long-term support costs are considered equally with near-term development and manufacturing costs.

ALIGNMENT: Performing the adjustments that are necessary to return an item to specified operation.

AMBIGUITY: The inability to distinguish which of two or more subunits of a product or item has failed.

AMBIGUITY GROUP: The number of possible subunits of a product or item identified by BIT, ETE, or manual test procedures, which might contain the failed hardware or software component.

APPENDIX G

ANTHROPOMETRICS: Quantitative descriptions and measurements of the physical body variations in people. These are useful in human factors design.

AUTOMATIC TEST EQUIPMENT (ATE): Equipment that is designed to automatically conduct analysis of functional or static parameters and to evaluate the degree of UUT (Unit Under Test) performance degradation; and may be used to perform fault isolation of UUT malfunctions. The decision making, control, or evaluative functions are conducted with minimum reliance on human intervention and usually done under computer control.

AVAILABILITY: A measure of the degree to which an item is in an operable and committable state at the start of a mission when the mission is called for at an unknown (random) time. (Item state at start of a mission includes the combined effects of the readiness-related system R & M parameters, but excludes mission time.)

-B-

BUILT-IN-TEST (BIT): An integral capability of the mission equipment which provides an on-board, automated test capability, consisting of software or hardware (or both) components, to detect, diagnose, or isolate product (system) failures. The fault detection and, possibly, isolation capability is used for periodic or continuous monitoring of a system's operational health, and for observation and, possibly, diagnosis as a prelude to maintenance action.

BUILT-IN TEST EQUIPMENT (BITE): Any device permanently mounted in the prime product or item and used for the express purpose of testing the product or item, either independently or in association with external test equipment.

-C-

CALIBRATION: A comparison of a measuring device with a known standard and a subsequent adjustment to eliminate any differences. Not to be confused with alignment.

CHECKOUT: Tests or observations of an item to determine its condition or status.

CHECKOUT TIME: That element of maintenance time during which performance of an item is verified to be a specified condition.

COMMERCIAL ITEM: Any item, other than real property, that is of a type customarily used for nongovernmental purposes and that has been sold, leased, or licensed to the general public, or has been offered for sale, lease, or license to the general public; items evolved from these items that are not yet available in the commercial market but will be in time to meet the delivery requirements of a solicitation. (See SD-2 or the Federal Acquisition Regulation, Parts 6, 10, 11, 12 and 14, for a complete definition and criteria.)

APPENDIX G

COMMERCIAL-OFF-THE-SHELF (COTS): Items available in a domestic or foreign commercial marketplace and usually ordered by part number.

COMPONENT: Within a product, system, subsystem, or equipment, a component is a constituent module, part, or item.

COMPUTER-AIDED DESIGN (CAD): A process which uses a computer system to assist in the creation, modification, verification, and display of a design.

CONFIGURATION ITEM (CI): A collection of hardware and software which satisfies a defined end-use function. The CI is designated for separate as-designed, as-built and as-shipped content makeup management control.

CONTRACT DELIVERABLES REQUIREMENTS LIST (CDRL): A listing of all technical data and information which the contractor must deliver to the Government.

CORRECTIVE ACTION: A documented design, process, procedure, or materials change implemented and validated to correct the cause of failure or design deficiency.

CORRECTIVE MAINTENANCE (CM): All actions performed as a result of failure, to restore an item to a specified condition. Corrective maintenance can include any or all of the following steps: Localization, Isolation, Disassembly, Interchange, Reassembly, Alignment and Checkout.

CRITICAL DESIGN REVIEW (CDR): The comparative evaluation of an item and program parameters. It is usually held just prior to production release after the item has reached a degree of completion permitting a comprehensive examination and analysis.

-D-

DATA ITEM DESCRIPTION (DID): A Government form used to define and describe the written outputs required from a contractor.

DELAY TIME: That element of downtime during which no maintenance is being accomplished on the item because of either supply or administrative delay.

DEMONSTRATION TEST: A test conducted under specified conditions, by, or on behalf of the customer, using items representative of the production configuration, in order to determine compliance with item design requirements as a basis for production approval. (also known as a "Qualification")

DEPENDABILITY: A measure of the degree to which an item is operable and capable of performing its required function at any (random) time during a specified mission profile, given item availability at the start of the mission. (Item state during a mission includes the combined

APPENDIX G

effects of the mission-related system R & M parameters but excludes non-mission time; see availability.)

DESIGN MAINTAINABILITY: A measure of inherent maintainability that includes only the effects of an item design and its application, but which is derived from the level of maintainability required in a specific operational and support environment.

DETECTABLE FAILURE: Failures at the component, equipment, subsystem, or system (product) level that can be identified through periodic testing or revealed by an alarm or an indication of an anomaly.

DEVELOPMENT TEST: Testing performed during development and integration to ensure critical design parameters are met, verify the performance of an item's design, and produce data supporting design improvements. Development test, sometimes called engineering test, also discloses deficiencies and verifies that corrective action effectively prevents recurrence of these deficiencies. Properly done, development test reduces the risk of redesign being necessary following demonstration testing or delivery to the customer.

DEVELOPMENT TEST AND EVALUATION (DT&E): Test and evaluation focused on the technological and engineering aspects of the product (system, subsystem, or equipment).

DIAGNOSTICS: The hardware, software, or other documented means used to determine that a malfunction has occurred and to isolate the cause of the malfunction. Also refers to "the action of detecting and isolating failures or faults."

DIRECT MAINTENANCE MANHOURS PER MAINTENANCE ACTION (DMMH/MA): A measure of the maintainability parameter related to item demand for maintenance labor. The sum of direct maintenance labor hours divided by the total number of preventive and corrective maintenance actions during a stated period of time.

DIRECT MAINTENANCE MANHOURS PER MAINTENANCE EVENT (DMMH/ME): A measure of the maintainability parameter related to item demand for maintenance labor. The sum of direct maintenance labor hours, divided by the total number of preventive and corrective maintenance events during a stated period of time.

DISASSEMBLE: Opening an item and removing a number of parts or subassemblies to make the item that is to be replaced accessible for removal. This does not include the actual removal of the item to be replaced.

DOWNTIME: That element of time during which an item is in an operational inventory but is not in condition to perform its required function.

APPENDIX G

-E-

ELEMENT MAINTENANCE ACTION: A unit of work into which a maintenance activity may be broken down at a given indenture level.

EQUIPMENT: A general term designating an item or group of items capable of performing a complete function.

-F-

FAILURE ANALYSIS: Subsequent to a failure, the logical systematic examination of an item, its construction, application, and documentation to identify the failure mode and determine the failure mechanism and its basic course.

FAILURE EFFECT: The consequence(s) a failure mode has on the operation, function, or status of an item. Failure effects are typically classified as local, next higher level, and end.

FAILURE MECHANISM: The physical, chemical, electrical, thermal or other process which results in failure.

FAILURE: The event, or inoperable state, in which any item or part of an item does not, or would not, perform as previously specified.

FAILURE, INTERMITTENT: Failure for a limited period of time, followed by the item's recovery of its ability to perform within specified limits without any remedial action.

FAILURE MODE: The consequence of the mechanism through which the failure occurs, i.e., short, open, fracture, excessive wear.

FAILURE MODE AND EFFECTS ANALYSIS (FMEA): A procedure by which each potential failure mode in a product (system) is analyzed to determine the results or effects thereof on the product and to classify each potential failure mode according to its severity or risk probability number.

FALSE ALARM: A fault indicated by BIT or other monitoring circuitry where no fault can be found or confirmed.

FALSE ALARM RATE (FAR): The frequency of occurrence of false alarms over a defined period of measure (e.g., time, cycles, etc.).

FAULT: Immediate cause of failure (e.g., maladjustment, misalignment, defect, etc.).

FAULT DETECTION (FD): A process which discovers the existence of faults.

APPENDIX G

FAULT ISOLATION (FI): The process of determining the location of a fault to the extent necessary to effect repair.

FAULT ISOLATION TIME: The time spent arriving at a decision as to which items caused the system to malfunction. This includes time spent working on (replacing, attempting to repair, and adjusting) portions of the system shown by subsequent interim tests not to have been the cause of the malfunction.

FRACTION OF FAULTS DETECTABLE (FFD): That fraction of all failures that occur over operating time, t , that can be correctly identified through direct observation or other specified means by an operator or by maintenance personnel under stated conditions.

FRACTION OF FAULTS ISOLATABLE (FFI): That fraction of all failures that occur over operating time, t , that can be correctly isolated to n or fewer units at a given maintenance level through the use of specified means by maintenance personnel under stated conditions.

FUNCTIONAL TEST: An evaluation of a product or item while it is being operated and checked under limited conditions without the aid of its associated equipment in order to determine its fitness for use.

-G-

GOVERNMENT-FURNISHED EQUIPMENT (GFE): An item provided for inclusion in or use with a producer service being procured by the Government.

GUIDE SPECIFICATION: This is a type of performance specification prepared by the Government. It identifies standard, recurring requirements that must be addressed when developing new systems, subsystems, equipments, and assemblies. Its structure forces appropriate tailoring to meet user needs.

-H-

HUMAN ENGINEERING (HE): The application of scientific knowledge to the design of items to achieve effective user-system integration (man-machine interface).

HUMAN FACTORS: A body of scientific facts about human characteristics. The term covers all biomedical and psychosocial considerations; it includes, but is not limited to, principles and applications in the areas of human engineering, personnel selection, training, life support, job performance aids, work loads, and human performance evaluation.

-I-

INACTIVE TIME: That time during which an item is in reserve. (In an inactive inventory).

APPENDIX G

INHERENT AVAILABILITY(A_i): A measure of availability that includes only the effects of an item design and its application, and does not account for effects of the operational and support environment.

INITIAL DELAY TIME: The time between the moment the product becomes available for maintenance and the moment work is commenced.

INITIAL ISOLATION: Isolation to the product subunit which must be replaced on line to return the product to operation. A subunit can be a modular assembly, or a component such as a crystal or antenna subsection. In the event that the maintenance concept requires a subunit to be removed, repaired and then replaced in the product, initial isolation includes both isolation to the failed subunit and isolation to the failed and removable portion of the subunit.

INITIAL ISOLATION LEVEL OF AMBIGUITY: The initial number of possible product subunits, identified by the built-in-test, built-in-test equipment, external test equipment, or manual test procedure, which might contain the failed component.

INTEGRATED DIAGNOSTICS: A structured process which maximizes the effectiveness of diagnostics by integrating pertinent elements, such as testability, automatic and manual testing, training, maintenance aiding, and technical information as a means for providing a cost effective capability to unambiguously detect and isolate all faults known or expected in items and to satisfy system mission requirements. Products of this process are hardware, software, documentation, and trained personnel.

INTEGRATED PRODUCT TEAM: A concurrent engineering team made up of individuals representing all relevant disciplines associated with a product's design, manufacturing, and marketing. All members work together using shared knowledge and capabilities to develop and manufacture a product in which requirements are balanced. The individuals must be committed to a common purpose, work to a unified set of requirements, and hold themselves accountable for decisions made and actions taken.

INTERCHANGE: Removing the item that is to be replaced, and installing the replacement item.

INTERCHANGEABILITY: The ability to interchange, without restriction, like equipments or portions thereof in manufacture, maintenance, or operation. Like products are two or more items that possess such functional and physical characteristics as to be equivalent in performance and durability, and are capable of being exchanged one for the other without alteration of the items themselves or of adjoining items, except for adjustment, and without selection for fit and performance.

INTERFACE DEVICE: An item which provides mechanical and electrical connections and any signal conditioning required between the automatic test equipment (ATE) and the unit under test (UUT); also known as an interface test adapter or interface adapter unit.

APPENDIX G

ISOLATION: Determining the location of a failure to the extent possible, by the use of accessory equipment.

-L-

LEVELS OF MAINTENANCE: The division of maintenance, based on different and requisite technical skill, which jobs are allocated to organizations in accordance with the availability of personnel, tools, supplies, and the time within the organization. Within the DoD, typical maintenance levels are organizational, intermediate and depot.

LIFE CYCLE COST (LCC): The sum of acquisition, logistics support, operating, and retirement and phase-out expenses.

LIFE CYCLE PHASES: Identifiable stages in the life of a product from the development of the first concept to removing the product from service and disposing of it. Within the Department of Defense, four phases are formally defined: Concept Exploration; Program Definition and Risk Reduction; Engineering and Manufacturing Development; and Production, Deployment, and Operational Support. Although not defined as a phase, demilitarization and disposal is defined as those activities conducted at the end of a product's useful life. Within the commercial sector, various ways of dividing the life cycle into phases are used. One way is: Customer Need Analysis, Design and Development, Production and Construction, Operation and Maintenance, and Retirement and Phase-out.

LINE REPLACEABLE UNIT (LRU): A unit designed to be removed upon failure from a larger entity (product or item) in the operational environment, normally at the organizational level.

LOCALIZATION: Determining the location of a failure to the extent possible, without using accessory test equipment.

LOGISTIC TIME: That portion of downtime during which repair is delayed solely to waiting for a replacement part or other subdivision of the system.

LOGISTICS SUPPORT: The materials and services required to enable the operating forces to operate, maintain, and repair the end item within the maintenance concept defined for that end item.

-M-

MAINTAINABILITY: The relative ease and economy of time and resources with which an item can be retained in, or restored to, a specified condition when maintenance is performed by personnel having specified skill levels, using prescribed procedures and resources, at each prescribed level of maintenance and repair. Also, the probability that an item can be retained in, or restored to, a specified condition when maintenance is performed by personnel having

APPENDIX G

specified skill levels, using prescribed procedures and resources, at each prescribed level of maintenance and repair.

MAINTAINABILITY ACTIVITIES BLOCK DIAGRAM: A diagrammatic representation of the necessary order of the various maintenance activities involved with a maintenance task for an item. Three possible orders exist: simultaneous, sequential, and a combination of simultaneous and sequential.

MAINTAINABILITY ALLOCATION: The apportionment of numerical requirements to all levels within a product which will result in meeting the overall maintainability requirement or goal.

MAINTAINABILITY DEMONSTRATION: A formal test specifically designed to measure maintainability by the use of objective evidence gathered under specified conditions.

MAINTAINABILITY MODEL: A quantifiable representation of a test or process the purpose of which is to analyze results to determine specific relationships of a set of quantifiable maintainability parameters.

MAINTAINABILITY PREDICTION: That maintainability performance which is expected at some future time, postulated on analysis of models, test, and past experience.

MAINTENANCE: All actions necessary for retaining an item in or restoring it to a specified condition.

MAINTENANCE ACTION: An element of a maintenance event. One or more tasks (i.e., fault localization, fault isolation, servicing and inspection) necessary to retain an item in or restore it to a specified condition.

MAINTENANCE CONCEPT: A description of the planned general scheme for maintenance and support of an item in the operational environment. It provides a practical basis for design, layout, and packaging of the system and its test equipment. It establishes the scope of maintenance responsibility for each level of maintenance and the personnel resources required to maintain the system.

MAINTENANCE ENVIRONMENT: The climatic, geographical, physical and operational conditions (e.g., combat, mobile, continental) under which an item will be maintained.

MAINTENANCE EVENT: One or more maintenance actions required to effect corrective and preventive maintenance due to any type of failure or malfunction, false alarm or scheduled maintenance plan.

MAINTENANCE RATIO: A measure of the total maintenance manpower burden required to maintain an item. It is expressed as the cumulative number of labor hours of maintenance

APPENDIX G

expended in direct labor during a given period of the life units divided by the cumulative number of end item life units during the same period.

MAINTENANCE TASK: The maintenance effort necessary for retaining an item in, or changing/restoring it to a specified condition.

MAINTENANCE TIME: An element of downtime which excludes modification and delay time.

MAXIMUM CORRECTIVE MAINTENANCE TIME FOR THE Φ PERCENTILE ($M_{Max(\Phi)}$): The maximum repair time associated with some percentage of all possible system corrective repair actions. (For example, 95% of all corrective repair actions must be accomplished in less than one hour.)

MEAN ACTIVE CORRECTIVE MAINTENANCE TIME (MACMT): The average time associated with active corrective maintenance actions. Time includes only actual repair time associated with a repair person performing corrective maintenance steps (i.e., Localization, Isolation, Disassembly, Interchange, Reassembly, Alignment, and Checkout).

MEAN DOWNTIME (MDT): The average time a system is unavailable for use due to a failure. Time includes the actual repair time plus all delay time associated with a repair person arriving with the appropriate replacement parts.

MEAN MAINTENANCE MANHOURS PER MAINTENANCE ACTION (MMH/MA): This term is defined in the same way as MMH/Repair except that time spent as a result of system failure false alarms must also be included in the maintenance labor hours.

MEAN MAINTENANCE MANHOURS PER REPAIR (MMH/REPAIR): The summation of the products of the mean maintenance labor hours expended to repair each given repairable item multiplied by the failure rate for the item, divided by the summation of the failure rates for all repairable items. The equation is given in MIL-HDBK-472, page V-7, as follows:

$$\overline{\text{MMH/Repair}} = \frac{\sum_{n=1}^N \lambda_n \overline{\text{MMH}_n}}{\sum_{n=1}^N \lambda_n}$$

Also, the total maintenance labor hours required to perform all repairs at any specific level of maintenance, divided by the number of repairs.

MEAN MAINTENANCE TIME: The measure of maintainability taking into account maintenance policy. The sum of preventive and corrective maintenance times, divided by the sum of scheduled and unscheduled maintenance events, during a stated period of time.

APPENDIX G

MEAN MANHOURS PER FLYING HOUR (MMH/FH): A maintainability performance figure calculated by dividing the labor hours expended to maintain a particular aircraft fleet during a given period, by the flying hours during that period.

MEAN MANHOURS PER OPERATING HOUR (MMH/OH): The total labor hours required to maintain a system divided by the number of operating hours. This includes labor hours associated with: corrective maintenance, preventive maintenance, and maintenance caused by false alarms.

MEAN TIME BETWEEN FAILURE (MTBF): A basic measure of reliability for repairable items. The mean number of life units during which all parts of the item perform within their specified limits, during a particular measurement interval under stated conditions.

MEAN TIME BETWEEN CRITICAL FAILURE (MTBCF): A measure of mission or functional reliability. The mean number of life units during which the item performs its mission or function within specified limits, during a particular measurement interval under stated conditions.

MEAN TIME BETWEEN MAINTENANCE (MTBM): A measure of the reliability taking into account maintenance policy. The total number of life units expended by a given time, divided by the total number of maintenance events (scheduled and unscheduled) due to that item.

MEAN TIME BETWEEN MAINTENANCE ACTIONS (MTBMA): A measure of the product reliability parameter related to demand for maintenance labor. The total number of product life units, divided by the total number of maintenance actions (preventive and corrective) during a stated period of time.

MEAN TIME BETWEEN REMOVALS (MTBR): A measure of the product reliability parameter related to demand for logistic support: The total number of system life units divided by the total number of items removed from that product during a stated period of time. This term is defined to exclude removals performed to facilitate other maintenance and removals for product improvement.

MEAN TIME TO REPAIR (MTTR): A basic measure of maintainability. The sum of corrective maintenance times at any specific level of repair, divided by the total number of failures within an item repaired at that level, during a particular interval under stated conditions.

MEAN TIME TO RESTORE SYSTEM (MTTRS): A measure of the product maintainability parameter, related to availability and readiness: The total corrective maintenance time, associated with downing events, divided by the total number of downing events, during a stated period of time. (Excludes time for off-product maintenance and repair of detached components.)

APPENDIX G

MEAN TIME TO SERVICE (MTTS): A measure of an on-product maintainability characteristic related to servicing that is calculated by dividing the total scheduled crew/operator/driver servicing time by the number of times the item was serviced.

MISSION MAINTAINABILITY: The measure of the ability of an item to be retained in or restored to specified condition when maintenance is performed during the course of a specified mission profile. (The mission-related system maintainability parameter.)

MISSION TIME: That element of up time required to perform a stated mission profile.

MISSION-TIME-TO-RESTORE-FUNCTIONS (MTTRF): A measure of mission maintainability: The total corrective critical failure maintenance time, divided by the total number of critical failures, during the course of a specified mission profile.

MODIFICATION: Major engineering changes to an existing product or item to effect improvements in design capabilities or characteristics.

MTTR ELEMENTS: Corrective maintenance actions consisting of the following tasks:

Preparation: Time associated with those tasks, including localization, required to be performed before fault isolation can be executed.

Fault Isolation: Time associated with those tasks required to isolate the fault to the level at which fault correction begins.

Disassembly: Time associated with gaining access to the replaceable item or items identified during the fault isolation process.

Interchange: Time associated with the removal and replacement item or suspected faulty item.

Reassembly: Time associated with closing up the equipment after interchange is performed.

Alignment: Time associated with aligning the system or replaceable item after a fault has been corrected.

Checkout: Time associated with the verification that a fault has been corrected and the product is operational.

Start-Up: Time associated with bringing a product up to the operational state it was in prior to failure, once a fault has been corrected and the operational status of the product verified.

APPENDIX G

-N-

NON-DEVELOPMENTAL ITEM (NDI): Any previously developed item used exclusively for governmental purposes by a Federal agency, a State or local government, or a foreign government with which the U.S. has a mutual defense cooperation agreement; any such item with minor modifications; and any item fully developed and in production but not yet in use. (See SD-2 or the Federal Acquisition Regulation Parts 6, 10, 11, 12 and 14, for a complete definition and criteria.)

NON-DESTRUCTIVE INSPECTION (NDI): Any method used for inspecting an item without physically, chemically, or otherwise destroying or changing the design characteristics of the item. However, it may be necessary to remove paint or other external coatings to use the NDI method. A wide range of technology is usually described as nondestructive inspection, evaluation, or testing (collectively referred to as non-destructive evaluation or NDE). The core of NDE is commonly thought to contain ultrasonic, visual, radiographic, eddy current, liquid penetrant, and magnetic particle inspection methods. Other methodologies, include acoustic emission, use of laser interference, microwaves, NMR and MRI, thermal imaging, and so forth.

NON-DETECTABLE FAILURE: Failures at the component, equipment, subsystem, or system (product) level that are identifiable by analysis but cannot be identified through periodic testing or revealed by an alarm or an indication of an anomaly.

-O-

OPERATIONAL ENVIRONMENT: The aggregate of all external and internal conditions (such as temperature, humidity, radiation, magnetic and electric fields, shock vibration, etc.) either natural or man made, or self-induced, that influences the form, operational performance, reliability or survival of an item.

OPERATIONAL MAINTAINABILITY: The assessed maintainability of an item based on field data.

OPERATIONAL READINESS: The ability of a military unit to respond to its operation plan(s) upon receipt of an operations order. (A function of assigned strength, item availability, status, or supply, training, etc.).

OPERATIONAL TEST AND EVALUATION (OT&E): Test and evaluation which focuses on the development of optimum tactics, techniques, procedures, and concepts for products and items, evaluation of reliability, maintainability and operational effectiveness, and suitability of products and items under realistic operational conditions.

APPENDIX G

-P-

PERCENT ISOLATION TO A GROUP OF RIs: The percent of time that detected failures can be fault isolated to a specified ambiguity group of size n or less, where n is the number of replaceable items (RIs).

PERCENT ISOLATION TO A SINGLE RI: The percent of time that detected failures can be fault isolated to exactly one replaceable item (RI).

PERFORMANCE SPECIFICATION (PS): A design document stating the functional requirements for an item.

PERFORMANCE-BASED REQUIREMENTS (SPECIFICATION): Requirements that describe what the product should do, how it should perform, the environment in which it should operate, and interface and interchangeability characteristics. They should not specify how the product should be designed or manufactured.

PREPARATION TIME: The time spent obtaining, setting up, and calibrating maintenance aids; warming up equipment; etc.

PREVENTIVE MAINTENANCE (PM): All actions performed in an attempt to retain an item in specified condition by providing systematic inspection, detection, and prevention of incipient failures.

PROCESS ACTION TEAM (PAT): A group of individuals with complementary skills, committed to a common purpose, set of performance goals, and approach for which they hold themselves accountable, who work together using shared knowledge and capabilities to improve business processes.

PROGRAM-UNIQUE SPECIFICATION. This type of Government specification, also called a system specification, establishes requirements for items used for a particular weapon system or program. Little potential exists for the use of the document in other programs or applications. It is written as a performance specification, but it may include a blend of performance and detail design type requirements.

-R-

REASSEMBLY: Assembling the items that were removed during disassembly and closing the reassembled items.

REDUNDANCY: The existence of more than one means for accomplishing a given function. Each means of accomplishing the function need not necessarily be identical.

APPENDIX G

RELIABILITY: (1) The duration or probability of failure-free performance under stated conditions. (2) The probability that an item can perform its intended function for a specified interval under stated conditions. (For non-redundant items this is equivalent to definition (1). For redundant items this is equivalent to definition of mission reliability.)

RELIABILITY-CENTERED MAINTENANCE (RCM): A disciplined logic or methodology used to identify preventive and corrective maintenance tasks to realize the inherent reliability of equipment at a minimum expenditure of resources.

REPAIR TIME: The time spent replacing, repairing, or adjusting all items suspected to have been the cause of the malfunction, except those subsequently shown by interim test of the system not to have been the cause.

REPLACEABLE ITEM (RI) or REPLACEABLE UNIT (RU): An item, unit, subassembly, or part which is normally intended to be replaced during corrective maintenance upon failure of the item.

REQUEST FOR PROPOSAL (RFP): A letter or document sent to suppliers asking to show how a problem or situation can be addressed. Normally the supplier's response proposes a solution and quotes a price. Similar to a Request for Quote (RFQ), although the RFQ is usually used for products already developed.

-S-

SCHEDULED MAINTENANCE: Periodic prescribed inspection and/or servicing of products or items accomplished on a calendar, mileage or hours of operation basis. Included in Preventive Maintenance.

SERVICING: The performance of any act needed to keep an item in operating condition, (i.e. lubricating, fueling, oiling, cleaning, etc.), but not including preventive maintenance of parts or corrective maintenance tasks.

STANDARD PERFORMANCE SPECIFICATION (SPS): A type of specification that establishes requirements for military-unique items used in multiple programs or applications.

STORAGE LIFE: The length of time an item can be stored under specified conditions and still meet specified operating requirements.

SUBSYSTEM: A combination of sets, groups, etc. which performs an operational function within a product (system) and is a major subdivision of the product. (Example: Data processing subsystem, guidance subsystem).

SUPPLY DELAY TIME: That element of delay time during which a needed replacement item is being obtained.

APPENDIX G

SUPPORT CONCEPT: A product-level description of maintenance needs consistent with an item's design and operational requirements.

SUPPORT ENVIRONMENT: The mobile, fixed and computer resources necessary for the operation and maintenance of a product under various environments but which are not physically part of the product. These resources are the people and the equipment required to make an item, product or facility operational as intended.

SYSTEM: General - A composite of equipment and skills, and techniques capable of performing or supporting an operational role, or both. A complete system includes all equipment, related facilities, material, software, services, and personnel required for its operation and support to the degree that it can be considered self-sufficient in its intended operational environment.

SYSTEM ADMINISTRATIVE TIME: System (product) downtime other than active maintenance time and logistic time.

SYSTEM DOWNTIME: The time interval between the commencement of work on a system (product) malfunction and the time when the system has been repaired and/or checked by the maintenance person, and no further maintenance activity is executed.

SYSTEM FINAL TEST TIME: The time spent confirming that a system (product) is in satisfactory operating condition (as determined by the maintenance person) following maintenance. It is possible for a system final test to be performed after each correction of a malfunction.

-T-

TESTABILITY: A design characteristic which allows status (operable, inoperable, or degraded) of an item to be determined and the isolation of faults within the item to be performed in a timely manner.

TEST MEASUREMENT AND DIAGNOSTIC EQUIPMENT (TMDE): Any product or item used to evaluate the condition of another product or item to identify or isolate any actual or potential failures.

TEST POINT: A jack or similar fitting to which a test probe is attached for measuring a circuit parameter or waveform.

TIME, TURN AROUND: That element of maintenance time needed to replenish consumables and check out an item for recommitment.

TOTAL SYSTEM DOWNTIME: The time interval between the reporting of a system (product) malfunction and the time when the system has been repaired and/or checked by the maintenance person, and no further maintenance activity is executed.

APPENDIX G

-U-

UNIT UNDER TEST (UUT): A UUT is any product or item (system, set, subsystem, assembly or subassembly, etc.) undergoing testing or otherwise being evaluated by technical means.

UNSCHEDULED MAINTENANCE: Corrective maintenance performed in response to a suspected failure.

UPTIME RATIO: A composite measure of operational availability and dependability that includes the combined effects of item design, installation, quality, environment, operation, maintenance, repair and logistic support: The quotient of uptime divided by the sum of uptime and downtime.)

UPTIME: That element of ACTIVE TIME during which an item is in condition to perform its required functions. (Increases availability and dependability).

USEFUL LIFE: The number of life units from manufacture to when the item has an unreparable failure or unacceptable failure rate. Also, the period of time before the failure rate increases due to wearout.

UTILIZATION RATE: The planned or actual number of life units expended, or missions attempted during a stated interval of calendar time.

-V-

VERIFICATION: The contractor effort to: (1) determine the accuracy of and update the analytical (predicted) data obtained from the maintainability engineering analysis; (2) identify maintainability design deficiencies; and (3) gain progressive assurance that the maintainability of the item can be achieved and be demonstrated in subsequent phases. This effort is monitored by the procuring activity from date of award of the contract, through hardware development from components to the configuration item (CI).

VIRTUAL REALITY: A combination of various interface technologies that enables a user to intuitively interact with an immersive and dynamic computer-generated environment.

This page has been left blank intentionally.

MIL-HDBK-470A

INDEX

Acronym	Defined on Page	Acronym	Defined on Page	Acronym	Defined on Page
A _i	1-8	FA	4-14	MLH/OH	D-8
ACAT	A-6	FAR	1-9	MMH	1-10
ACMT ₉₅	1-8	FD	1-9	MMH/FH	1-10
AFL	B-40	FD&I	1-9, D-4	MMH/OH	1-10
AI	1-8	FFD	1-9	MR	1-10
AIAG	1-8	FFI	1-9	MTBF	1-10
ALU	B-76	FH	D-9	MTBM	1-10, A-11
ANSI	1-8	FI	1-9	MTBPM	1-10
A _o	1-8, A-11, B-9	F ³ I	2-11	MTTR	1-10, D-3
ARINC	1-8, B-9	FMEA	1-9, B-14	MTTR _G	B-37
ASIC	4-13	FMECA	1-9	MTTRF	1-10
ATA	1-8	FOD	C-11	MTTRS	1-10
ATE	B-75	FRACAS	1-9	MTTS	1-10
AWM	1-8	FRCM	4-49	MTUT	1-10
AWP	1-8	FSC	1-9		
		FTA	1-9	NASA	1-10
BIT	1-8, B-71, C-5			NATO	1-10
BITE	1-8	GS	A-3	NCMDT	B-40
				NDI	1-10, A-8
CAD	1-8	HE	1-9	NOF	B-40
CAM	1-8			NORS	B-40
CDRL	A-18	IC	1-9	NRTS	1-10
CID	1-8, A-3	ID	4-14		
CM	1-8, D-4	IEC	1-9	O&M	1-10
CMDT	B-40	IEEE	1-9	OC	B-29
CND	1-8, B-71	ILS	1-9	OH	D-3
COTS	1-8	IOT&E	1-9, E-5	OT&E	G-13
CRT	1-8	IPD	1-9, B-72		
CUT	C-5	IPDT	4-26	P&C	1-10
				PAT	1-10, A-1
DAR	1-9	LFSR	B-80	PCB	1-10
DDT	B-40	LRU	1-9, B-13,	PLA	B-77
DMH	1-9		C-4	PM	1-10
DMH/MA	1-9	LSA	1-9	PR&P	1-10
DoD	1-9, A-1				
DoDISS	A-3	M _{CT}	B-21	QFD	3-2
DT	1-9	M _{MAX} Φ	1-10		
DT&E	1-9, E-5	MA	1-9	R&D	1-10
DUR	B-40	MACMT	1-9	R&M	1-10
DUT	B-75	MAISAP	1-9	R/R	1-10
		MDAP	1-9	RAC	1-10
EDIF	4-40	MDS	1-9	RADC	D-1
EMD	1-9, E-1	MDT	1-10, A-11	RCM	1-10
EMI	1-9	MFD	D-25	RFP	1-10, A-9
EMT	1-9	MICAP	1-10	RI	1-10, D-2
ERT	B-37	MLH	1-10, D-3	ROM	C-5
ETE	1-9	MLH/FH	D-3	RTOK	1-10, B-71
ETI	1-9	MLH/MA	D-7	R/T	4-44

INDEX

Acronym	Defined on Page
RU	1-10
SAE	1-10
SMD	1-10
SOO	1-11, A-8
SOW	1-11, A-8
SPS	1-11, A-3
SRA	C-4
SRD	1-11
SRU	C-3
STAMP	1-11
STAT	1-11
TR	1-11
TSMD	1-11
UUT	G-17
VE	1-11
VLSI	C-6
VR	1-11
WRA	C-4
WSTA	1- 11
WUC	1- 11

MIL-HDBK-470A

INDEX

Index Term	Page Number	Index Term	Page Number
	(A)		
Acceptance		Automatic Test Equipment	B-75, B-82
criteria	B-20, B-38, B-49, B-59, B-61, B-65	Availability	
level	B-38, B-39, B-61	equation	2-3
testing	B-1	inherent	2-3
Accessibility	3-5, 4-4, 4-6, 4-9, 4-13, 4-24, 4-41, A-15, B-4, B-5, B-11, E-6	operational	2-4, A-11
Accident	B-40, B-69	requirements	4-3
Acquisition		Awaiting maintenance	4-32
category	A-6	Awaiting parts	4-32
Costs	See "Costs"		(B)
definition phase	4-62	Baseline	D-10
Deskbook	A-4	Battle damage	B-40, C-10
document(s)	A-4	Behavioral models	B-78
DoD Phases	2-5, Appendix E	Benchmarking	1-4, 2-11
guidance	Appendix A	Built-in	
in-service phase	4-62	diagnostics	B-23
manufacturing phase	4-62	self-test	B-80
O&M phase	2-6, 3-7	Built-in test (BIT)	2-6, 3-6, 4-12, 4-14, 4-17, 4-32, 4-34, 4-43, 4-58, B-4, B-71
phase(s)	E-1	analyses results	A-18
policy(ies)	A-2, A-4	effectiveness	4-32, B-4
reform	2-11, 4-1, A-1, A-4, A-7 - A-9	failures	B-72
regulations	A-4	performance	B-72
retirement phase	2-5, 2-7, 3-7		(C)
Active		CAD	See "Computer-aided design"
corrective maintenance	A-19	Cannot duplicate (CND)	4-13, 4-15, B-69
maintenance	4-42, D-2	Central Limit Theorem	B-28, B-41, B-43, B-47, B-57
Administrative	B-12, B-38, B-66, D-2	Chargeable	
delay downtime	B-39	downtime	B-39, B-40, B-45
requirements	B-66	maintenance	B-39, B-45, B-67
delays	4-33	maintenance downtime	B-39, B-45
Affordability	2-7	Checkout	B-11, B-63, D-4, D-14
Alarm rate(s)	4-43, A-12, A-19, B-71, D-8	Commercial	
Alarm(s)	4-58, A-12, A-19, D-21, D-7	acquisition	A-8
Algorithm(s)	B-72, B-76, B-79, B-84	customers	A-7
Alignment	D-4	fault simulation	B-83
Allocation	4-47	product(s)	2-11
Equal Distribution Method	4-51	specifications	A-1, A-7, A-23
FR Complexity method	4-48, 4-50	standard(s)	A-1, A-2
of requirements	4-3	Compliance testing	4-63
Statistically-Based Method	4-50	Computer-aided-design (CAD)	4-2, 4-21, 4-22, 4-24, 4-26, 4-40
Allocation(s)	A-22, B-71, E-5	Concept	
Alternate		definition	D-10, D-21
concepts	A-5, E-3	exploration	2-5, A-5, E-1
hypothesis	B-28, B-32	studies	E-1
Ambiguity(ies)	2-2, 4-5, 4-14, 4-15, 4-17, 4-27, 4-38, 4-58	Concurrent engineering	2-8, A-22
group(s)	A-12, B-74	Condition monitoring	4-9
Analysis(es) (Analytical)	A-12, B-72	Confidence level(s)	A-19, B-20, B-22, B-44, B-61, B-85
accessibility	4-41	Configuration control	2-6, 2-11, 4-6
criticality	4-34	Configuration management	2-6, A-10
dependency	4-38	Consumer risk(s)	B-5, B-41
downtime	4-32	Corrective Action	4-22, 4-33, 4-53, 4-58, 4-65
FMEA	2-4, 4-17, 4-34		
human factors	4-32, 4-40	Correlation Matrix	D-23, D-29
testability	4-15, 4-32, 4-37	Costs	
tool(s)	4-2, 4-21, 4-39, A-7	acquisition	2-5, 2-8
Anthropometric(s)	4-11, 4-21, A-20	design	4-22
characteristics	2-9	life cycle	1-2, 2-5
measurements	4-11	maintenance	2-6, 4-13
Artificial Intelligence	4-25	O&M	2-6, 2-11
Assessment(s)	4-33, A-5, B-70, B-73, E-2, E-6	opportunity & equivalent	2-7
Audit trail	4-25, 4-27, 4-31	ownership	2-8, 4-3
Augmented reality	4-24	production & construction	2-6
Automated maint. analysis	D-1	R&D	2-5
		retirement & phaseout	2-7

MIL-HDBK-470A

INDEX

Index Term	Page Number	Index Term	Page Number
	(D)		
Data		Diagnostic(s)	
accuracy	4-62	capabilities	3-6, 4-12, 4-15, 4-26, B-3
acquisition methods	B-20, B-23, B-65, B-76	design principles	4-13
analysis method(s)	4-62	tests	B-73, B-74
collection	2-6, 4-8, 4-9, 4-58, B-4, E-6	tools	4-25
element(s)	B-4	Disposal	2-5, 2-7, 3-7, A-6, E-1, E-6
items	A-18, A-23, D-3	Distribution(s) (statistical)	4-46, 4-50, 4-53 to 4-58, 4-63, 4-64
sources	4-60, A-23, B-4	Duty cycle(s)	B-16
system(s)	4-16, 4-58, 4-60		(E)
Decision		Elapsed Maintenance	4-32
criteria	B-5, B-20, B-31	Elemental	
milestone	A-5, E-2	maintenance actions	D-30, D-31
procedure	B-28, B-31, B-34, B-37, B-45, B-47	activity/tasks	D-11, D-13, D-16
Defense Acquisition Reform	4-1, A-1, A-4, A-7	times	D-27, D-29
Deficiencies	B-2, B-3, B-64, B-68, B-70, D-1, E-2	Environment(al)	2-6, 2-10, 4-2, 4-6, 4-11, 4-16, 4-19, 4-21, 4-23, 4-32, 4-42, 4-53, 4-62, A-7, A-12, B-8, B-10, B-72
Degradation	4-8, 4-15	conditions	4-16, 4-60, D-30
Demilitarization	2-5, 3-7, A-6, E-1, E-6	factors	4-6, 4-15
Demonstration/verification	B-2, B-5	stress(es)	4-16
Data	4-46, 4-62	Evaluation(s)	2-5, 4-22, 4-31, 4-41, 4-48, 4-63, B-1, B-4, B-12, B-64, B-73, E-5
environment	B-10	4-21, 4-25	
evaluation	B-1, B-62, B-71	Expert system	2-5, E-1, E-3
method(s)	B-6, B-16, B-22, B-36, B-65, B-71	Exploration phase	
plans	B-20		(F)
population	B-16, B-22	Facility (ies)	2-6, 2-10, 4-2, 4-19, B-11, B-65, B-77
techniques	B-4, B-71, D-31	Failure(s)	
test (ing)	1-2, 2-6, 3-5, 4-52, 4-58, A-22, B-2, B-6, B-7, B-73	analysis	2-6
test(s)	B-6, B-11, B-23	induced	4-18, B-4, B-12, B-13, B-68, B-71
Dependability	4-60	intermittent	4-16
Dependency analysis	4-38	mechanism(s)	B-4, B-76
Deployment	2-5, A-6, E-1, E-6	rate weighted(ing)	D-14, D-16, D-18
Depot	2-10, 4-4, 4-13, 4-47, B-2, B-5, B-8, B-64, D-2, D-10	rate(s)	4-13, 4-20, 4-33, 4-40, 4-45, B-14, B-46, D-3
Design		reporting	4-58, 4-65, B-3
attributes	B-72, E-3	simulation	B-19, B-64, B-66, B-74, B-76, B-78, B-80, B-82, B-86
changes	4-4, 4-43, E-5	symptoms	4-28
characteristics	2-4, 3-2, 4-12, 4-34, 4-42, B-74	False alarm(s)	4-9, 4-15, 4-34, 4-58, D-7
costs	See "Costs"	rate(s)	4-32, 4-43, A-12, A-17, A-19, B-71, D-8
criteria	4-31, 4-34	Fault coverage	B-73, B-75, B-73, B-80, B-86
data	2-11, 4-24, 4-60	Fault detection	2-2, 4-9, 4-13, 4-32, 4-37, 4-42, 4-52, 4-58, B-3, B-74, B-82, D-4, D-21, D-25
deficiencies	B-1, B-3	Fault(s)	
evaluation	4-22, 4-32	correction	D-4, D-25
expert system	4-26	dictionaries	4-15, 4-38, B-74
goal(s)	4-18	equivalence(ing)	B-76, B-80, B-86
guidelines	1-2, 3-6, 3-7, 4-18, 4-40, Appendix C	inducement	B-13, B-19
principles	4-13, 4-19, 4-20	insertion methods	B-71
process(es)	2-9, 4-4, 4-6, 4-13, 4-21, 4-40, 4-43, B-3, B-74	isolatable	4-14, 4-38, 4-43
requirements	2-11, 3-2, 4-22, 4-32, A-3, A-12	model	B-73, B-80
reviews	D-2, D-16	sampling	B-75, B-83, B-86
team	4-3, B-5, E-3	selection	B-19
Detect(ion)	2-1, 3-5, 4-21, 4-26	signature	4-14, B-73
capability	B-3	simulation(s)	4-15, 4-20, 4-21, 4-23, 4-37, 4-53, B-74, B-80, B-81, B-82
efficiency	4-37	simulator(s)	B-73, B-74, B-77, B-82, B-86
of faults/failures	2-2, 4-9, 4-12, 4-34, 4-37, 4-42	Faulty logic model	B-75
Detection (continued)			
percentage(s)	4-37		
requirements	4-14		
Development			
costs	2-5		
phase	2-5, B-2, E-1		
test(s) and testing	3-6, 4-1, 4-52, A-22		

MIL-HDBK-470A

INDEX

Index Term	Page Number	Index Term	Page Number
Support			(V)
analysis	4-34, E-6	Virtual mock-ups	B-4
concept(s)	2-10, 4-4, 4-9, 4-32, A-9, A-20	Virtual Reality	
costs	See "Costs"	application of	4-24
disciplines	2-8	environment	4-24
elements	B-65	mockups	4-23, B-5
environment	4-6, 4-53, A-20, B-2, B-64	simulation	3-6, 4-23
equipment	2-4, 2-6, 2-10, 4-12, B-65, B-68, B-70	types	4-24
facilities	4-19, E-6		(W)
personnel	2-6, 2-10	Warranty	
phase	2-5, E-6	Data	3-6
requirements	2-10, 4-16, 4-31	Information	2-11
Supportability	3-1, 4-21, 4-33	Period	4-65
System(s)			
design	2-9, 4-39		
diagnostics	4-15, B-71		
downtime	4-33		
engineering	1-1, 3-1, 3-5, 4-13, 4-22, 4-43		
life cycle	B-2		
specifications	A-1, A-3		
testing	2-5		
	(T)		
Task			
analysis	B-4		
group(s)	B-13, B-15, B-18		
sampling	B-12, B-22, B-66		
selection	B-19, B-22, B-37, B-58, B-61, B-66		
times	B-4, B-13, B-57, B-61, D-3, D- 28		
Teams (IPDTs)	4-26		
Tear-down analyses	2-7, E-6		
Technical manuals	2-10, B-65, B-68		
Telepresence	4-24		
Test(ing)			
effectiveness	4-16, 4-17		
formal maintainability	4-52		
objectives	4-52, B-64		
plans	3-6, Appendix B		
types	4-52		
Testability			
analysis	4-15, 4-32, 4-34, 4-37 to 4-41		
analyzer	4-38		
defined	2-1, 2-9, 4-12		
demonstration	Appendix B		
design	4-13, 4-40, Appendix C		
handbook	4-40		
metrics	B-71		
verification	Appendix B		
Trade-offs	2-2, 2-4, 2-10, 4-17, 4-43		
Trade/Tradeoff studies	2-5, 4-4, 4-31, 4-45, A-18, A-22, E-3		
Training	2-1, 2-4, 2-6, 2-10, 3-1, 3-6, 4- 12, 4-16, 4-19, 4-25, 4-30, 4-46, 4-62, B-40, B-65, B-68, B-71, D- 2, E-6		
Troubleshooting	4-12, 4-34, 4-58		
	(U)		
Undetectable fault(s)	B-77, B-81, B-86		
Uniform distribution	B-18		
Unit replacement	B-13		
Useful life	2-5, 3-7, 4-58, A-6, E-1, E-6		

MIL-HDBK-470A

CONCLUDING MATERIAL

CUSTODIANS:

ARMY - SY
NAVY - AS
AIR FORCE - 17
DLA - DH

PREPARING ACTIVITY:

AF-17
(PROJECT MNTY-0016)

REVIEW ACTIVITIES:

ARMY - IE, MI, PT, TM2
NAVY - AS, CG, EC, MC, NP, SA, TD
AIR FORCE - 08, 10, 13, 19, 21, 33
DLA - DH
DIA - DI
NSA - NS
NORAD - US
OSD - HS, MA

STANDARDIZATION DOCUMENT IMPROVEMENT PROPOSAL

INSTRUCTIONS

1. The preparing activity must complete blocks 1, 2, 3, and 8. In block 1, both the document number and revision letter should be given.
2. The submitter of this form must complete blocks 4, 5, 6, and 7.
3. The preparing activity must provide a reply within 30 days from receipt of the form.

NOTE: This form may not be used to request copies of documents, nor to request waivers, or clarification of requirements on current contracts. Comments submitted on this form do not constitute or imply authorization to waive any portion of the referenced document(s) or to amend contractual requirements.

I RECOMMEND A CHANGE:

1. DOCUMENT NUMBER
MIL-HDBK-407A

2. DOCUMENT DATE (YYMMDD)
97/08/04

3. DOCUMENT TITLE DESIGNING AND DEVELOPING MAINTAINABLE PRODUCTS AND SYSTEMS

4. NATURE OF CHANGE *(Identify paragraph number and include proposed rewrite, if possible. Attach extra sheets as needed.)*

5. REASON FOR RECOMMENDATION

6. SUBMITTER

a. NAME *(Last, First, Middle Initial)*

b. ORGANIZATION

c. ADDRESS *(Include Zip Code)*

d. TELEPHONE *(Include Area Code)*
(1) Commercial
(2) AUTOVON
(if applicable)

7. DATE SUBMITTED
(YYMMDD)

8. PREPARING ACTIVITY

a. NAME
ROME LABORATORY/ERSR

b. TELEPHONE *Include Area Code)*
(1) Commercial (315) 330-4205
(2) AUTOVON 587-4205

c. ADDRESS *(Include Zip Code)*
525 BROOKS RD.
ROME, NY 13441-4505

IF YOU DO NOT RECEIVE A REPLY WITHIN 45 DAYS, CONTACT:
DEFENSE QUALITY AND STANDARDIZATION OFFICE
5203 Leesburg Pike, Suite 1403, Falls Church, VA 22401-3466
Telephone (703) 756-2340 AUTOVON 289-2340

**NOT MEASUREMENT
SENSITIVE**

**MIL-HDBK-470A
4 AUGUST 1997
SUPERSEDING
MIL-HDBK-470
12 JUNE 1995
MIL-HDBK-471
12 JUNE 1995**

DEPARTMENT OF DEFENSE HANDBOOK

DESIGNING AND DEVELOPING MAINTAINABLE PRODUCTS AND SYSTEMS

VOLUME II APPENDIX C: DESIGN GUIDELINES



This handbook is for guidance only. Do not cite this document as a requirement

AMSC N/A

AREA MNTY

DISTRIBUTION STATEMENT A. Approved for public release; distribution is unlimited.

This page has been left blank intentionally.

APPENDIX C

TABLE OF CONTENTS

C.1	Scope.....	C-1
C.2	Introduction.....	C-1
C.2.1	Use of the Guidelines.....	C-3
C.2.2	Special Guidance.....	C-4
C.2.2.1	Testability.....	C-4
C.2.2.2	Safing and Arming.....	C-11
C.3	List of Guidelines.....	C-13
C.4	Guidelines by Category.....	C-47

FIGURES

Figure C-1:	Redundancy BIT.....	C-5
Figure C-2:	Wrap-Around BIT.....	C-6

TABLES

Table C-I:	Categories of Product Subsystem, Equipment, and Component Maintainability Guidelines.....	C-1
Table C-II:	Alpha Prefixes for Guidelines.....	C-3
Table C-III:	Categories of Part Types and Technologies from RL-TR-92-12, Vol. I.....	C-6
Table C-IV:	Inherent Testability Checklist.....	C-7

This page has been left blank intentionally.

APPENDIX C

DESIGN GUIDELINES**C.1 Scope**

This Appendix is an essential part of MIL-HDBK-470A. The information contained herein is intended for guidance only. This Appendix is for guidance only and cannot be cited as a requirement. If it is, the contractor does not have to comply.

C.2 Introduction

Although quantitative measures are used extensively to evaluate the maintainability of a design as it evolves, much of the "art" of designing for maintainability involves the application of tried and true design criteria or guidelines. This appendix includes several hundred such guidelines; some are generic and applicable to all types of products, while others are applicable to specific types of products. Guidelines are provided for the categories of product characteristics, subsystems, equipment, and components shown in Table C-I.

TABLE C-I. Categories of Product Characteristics Subsystem, Equipment, and Components.

2.01 Accessibility	3.03 Structure
2.02 Fasteners	3.03.01 Radomes
2.03 Human Factors	3.03.02 Drains & Vents
2.04 Mating and Connections	3.06 Avionics & Electronics
2.05 Standardization and Interchangeability	3.06.01 Antennas, Apertures, & Sensors
2.06 Simplification	3.06.02 Communications, Command & Control
2.07 Modularization	3.06.03 Computers
2.08 Testability and Diagnostics Technique	3.06.04 Power Supply
2.08.01 System Testability Design	3.06.05 Information Systems
2.08.02 System/Subsystem BIT/BITE	3.07 Environmental Control, Air Conditioning, and Pressurization
2.08.03 Module Level Testability Guidelines	3.07.01 Oxygen Systems
2.09 Module BIT/BITE	3.08 Armament & Explosives
2.09.01 General BIT	3.08.01 Armor
2.09.02 General BIT Techniques	3.08.02 Weapons, Guns, Flares, Chaff, & Cannon
2.10 Inherent Testability Design Checklist	3.08.03 Cartridge Actuated Devices, Shaped Charges, Detonating Cord, & Pyrotechnic Devices
2.11 Preventive Maintenance	3.09 Fluid Systems
2.11.01 Environmental Factors	3.09.01 Fuel Systems, Tanks, Containers, Pumps, Trucks, & Bladders
3.01 Connections	3.09.02 Pneumatic Systems & Pumps
3.01.01 Plumbing, Hoses, Fittings, & Quick Disconnects	3.09.03 Hydraulic Systems, Tanks, Pumps, Accumulators, & Reservoirs
3.01.02 Wiring, Connectors, & Fiber Optics	3.10 Wheels & Related
3.01.03 Coaxial Connectors & Wave Guides	3.10.01 Tracks
3.01.04 Control Rods, Cables, & Controlex Concept	3.10.02 Wheels, Tires, & Brakes
3.02 Power	3.10.03 Landing Gear & Alighting Gear
3.02.01 Engines (Gasoline & Diesel)	3.10.04 Skids & Floats
3.02.02 Engines (Turbine-driven)	3.10.05 Hooks & Catapults
3.02.03 Transmissions, Clutches, & Rotors	3.11 Personnel Equipment
3.02.04 Auxiliary, Secondary, & Emergency Power	3.11.01 Oxygen Systems, Masks, Controls, & Containers
3.02.05 Gear Boxes & Drives	3.11.02 Personnel Protective Garments & Equip
3.02.06 Exhaust Exits, Nozzles, & Outlets	3.11.03 Flotation Equipment
3.02.07 Inlets & Inlet Ducts	3.11.04 Parachutes
3.02.08 Electrical	

APPENDIX C

TABLE C-I. Categories of Product Characteristics Subsystem, Equipment, and Components. (continued)

3.12 Low Observable Technologies	3.14 Test & Diagnostics
3.13 System Support	3.14.01 Non-destructive Test & Inspection
3.13.01 Support & Ground Handling Equipment	3.14.02 Built-in Test & Built-in Test Equipment
3.13.02 Cleaning & Decontamination	3.14.03 External Test Equipment
3.03.03 Crew Stations, Crew Cabs, Cockpits, & Personnel Enclosures	3.15 Man-Machine Interfaces
3.03.04 Access Doors, Panels, & Openings	3.15.01 Displays & Instrumentation
3.03.05 Windshields, Windows, Canopies, & Optics	3.15.02 Service, Caution, Warning, & Advisory Lights & Indicators
3.03.06 Structures, Airframes, Bodies, Chassis, & Hulls	3.15.03 Data Entry
3.03.07 Cargo Holds, Storage Bays, & Storage Compartments	3.15.04 Controls
3.03.08 Weapon Bays, Racks, Compartments, Pylons, Housings & Turrets	3.15.05 Access
3.03.09 External & Parasitic Tanks Pods, Containers, & Devices	3.16 Equipment Decontamination
3.03.10 Personnel Seats (Crew & Passenger), Ejection Seats, Benches, & Chairs	3.17 Survival Equipment
3.03.11 Materials, Treatments, Coatings, & Finishes	3.17.01 Survival Packs
3.04 Control	3.17.02 Dinghies, Boats
3.04.01 Steering & Directional Control	3.17.03 Pods & Capsules
3.04.02 Flight Control Systems & Air Cushion Systems	3.17.04 Backpacks
3.04.03 Thrusters	3.18 Tools
3.05 Mechanisms	3.18.01 Standard and Special
3.05.01 Bellcranks, Pivots, Mechanical Advantage Devices, Shift Devices, Ratio Changers, Bulkhead/Firewall Penetrators, etc.	3.19 Miscellaneous
	3.19.01 Extinguishing Agents, Containers, Controls, & Devices
	3.19.02 Safe/Arm Devices
	3.19.03 Anti-ice, De-fog, De-ice, & Windshield Cleaning Systems
	3.19.04 Chemical, Biological, & Nuclear Environments & Protection

Most of the design guidelines presented in this appendix were developed over many years experience gained by McDonnell Douglas in designing aircraft, helicopters, and vehicles, and the various subsystems and components used in these products. Some guidelines were recommended by design and maintainability engineers from various companies and professional societies and associations who reviewed the early drafts of the appendix. Few, if any, of the guidelines are absolutes that must or can be followed in every case. Other requirements, as discussed in MIL-HDBK-470A, such as manufacturing considerations, may make it impractical to incorporate certain guidelines even when they may be desirable from a maintainability perspective.

Each guideline is presented with a brief explanation of its purpose. For example, consider guideline Number C-1:

Avoid swivel type connectors and fittings for air, fuel, and hydraulic line interfaces due to their history of low reliability.

This guideline does not prohibit the use of swivel type connectors and fittings. However, if used, some action must be taken to avoid the problem of low reliability encountered in the past. Also, if a trade is to be made, whatever advantages might be obtained through the use of swivel connectors would have to be weighed against its historically low reliability (and the correspondingly high maintenance rate). Indeed, design guidelines allow realistic trade-offs to be made among the various design considerations (i.e., maintainability, other performance, requirements, manufacturability, safety, etc.).

APPENDIX C

C.2.1 Use of the Guidelines.

Each guideline is assigned an alphanumeric "number"; the alpha prefix denotes the type of equipment, subsystem, or area to which the guideline primarily applies. See Table C-II for an explanation of these alpha prefixes¹. The numeric suffix is simply a randomly assigned sequential number. The guidelines are first listed by their alphanumeric number in ascending order. Then, each category from Table C-I is listed and all guidelines that apply to that category are listed. The exception are the general human factors guidelines which, since they apply to nearly all categories, are listed only under 2.03 Human Factors.

TABLE C-II. Alpha Prefixes for Guidelines.

Abbrev.	Meaning	Abbrev.	Meaning
AA&S	Antennas, Apertures, and Sensors	HOOK	Hooks, and Catapults
ACS	Air Cushion Systems	HYD	Hydraulic Systems, Tanks, Pumps, Accumulators, and Reservoirs
ARM	Armor	IN	Inlets and Inlet Ducts
BIT	Built-in-Test	IN(V)	VTOL Top Mounted
BIT-M	Module BIT	LG	Landing Gear and Alighting Gear
BIT/BITE	Built-in Test and Built-in Test Equipment	LO	Low Observable Technologies
C	Plumbing, Hoses, Fittings, and Quick Disconnects	MATL	Materials, Treatments, Coatings, and Finishes
CARGO	Cargo Holds, Storage Bays, and Storage Compartments	MC	Mating and Connections
CBR	Chemical, Biological, & Nuclear Environments & Protection	MG	Mechanical Guidelines
CC	Cabling and Connections	MP	Mechanical and Physical Guidelines
CO	Computers	NDI	Non-destructive Test and Inspection
CONT	Control Rods, Cables, and Controlex Concept	OXY	Oxygen Systems
CREW	Crew Stations, Crew Cabs, Cockpits, and Personnel Enclosures	P	Access Doors, Panels, and Openings
D&V	Drains and Vents	PERS	Personnel Equipment
EC	Electrical Connectors	PYRO	Cartridge Actuated Devices, Shaped Charges, Detonating Cord, and Pyrotechnic Devices
ECS	Environmental Control, Air Conditioning, and Pressurization	R	Radomes
EDECOM	Equipment Decontamination	SABCH	Structures, Airframes, Bodies, Chassis, and Hulls
EG	Electrical Guidelines	SAFE	Safe/Arm Devices
ENG	Engines (Turbine-driven)	SE	Support and Ground Handling Equipment
ENG(G)	Engines (Gasoline and Diesel)	SEAT	Personnel Seats (Crew and Passenger), Ejection Seats, Benches, and Chairs
ENV	Environmental Factors	SI	Simplification
EXH	Exhaust Exits, Nozzles, and Outlets	SKID	Skids and Floats
EXT	External and Parasitic Tanks, Pods, Containers, and Devices	SURV	Survival Equipment
EXTING	Extinguishing Agents, Containers, Controls, and Devices	T	Thrusters
F	Fasteners	TCR	Transmissions, Clutches, and Rotors
FI	Fault Isolation	TOOLS	Tools
FUEL	Fuel Systems, Tanks, Containers, Pumps, Trucks, and Bladders	TP	System Test Points
GBD	Gear Boxes and Drives	W	Wiring, Connectors, and Fiber Optics
HF	Human Factors	WBAY	Weapon Bays, Racks, Compartments, Pylons, Housings, and Turrets
		WIND	Windshields, Windows, Canopies, and Optics
		WT&B	Wheels, Tires, and Brakes

¹ Note that there is not a one-to-one correlation between the prefixes and the categories shown in Table C-I. Initially, as the guidelines were developed, it was thought that each category would have unique guidelines. This did not turn out to be the case and many guidelines apply to more than one category. Dropping the prefix and just numbering the guidelines was considered but it was felt that having some categorization of guidelines would make the addition of new ones easier, so the prefix was retained.

APPENDIX C

The guidelines are most helpful if the following steps are followed.

- Screen guidelines for applicability prior to initiating conceptual layouts to assure the maximum degree of proactivity.
- Screen guidelines on an iterative basis as the level of design detail increases.
- Make those guidelines applicable to a specific type of product, wherein ignorance of the guideline might result in vehicle accident/loss, personnel death or injury, collateral damage, or seriously detract from performing the function or mission, the subject of special project awareness prior to exiting the conceptual design phase.

Once the type of product is established, and the appropriate guidelines are identified, efforts should be directed to translating each guideline into specific quantitative and qualitative "design to" criteria. As technology changes, the maintainability guidelines must be revised, expanded, and otherwise kept current. Users of this appendix are encouraged to keep their own tailored list of design for maintainability guidelines.

Many of the guidelines refer to line-replaceable units (LRUs), shop-replaceable units (SRUs), weapon-replaceable assemblies (WRAs), and shop-replaceable assemblies (SRAs). The former are terms used within the US Air Force, and the latter used within the US Navy. LRU and WRA refer to items that are repaired in place or replaced on the end product (e.g., the aircraft, tank, truck, etc.). SRU and SRA refer to items that must be repaired off of the end product, usually at some level of maintenance called intermediate, shop, or depot.

Two terms used in the guidelines may not be familiar. These terms and their definitions are:

- Parasitic - Parasitic is a term used in connection with structure, armor, patches and repairs, and tanks. Parasitic structure or armor is structure or armor that is bolted or scabbed in place. A parasitic patch or repair is one that is scabbed in place and is not flush with the surrounding surface. A parasitic tank is a conformal or pallet tank.
- Hard point - Structural attachment and load bearing area. Used to mount equipment or external stores or weapons, or for jacking or supporting a structure.

C.2.2 Special Guidance.

C.2.2.1 Testability.

Many of the testability and diagnostics guidelines in Sections C-3 and C-4 have been excerpted from RL-TR-92-12, *TESTABILITY DESIGN GUIDE RATING SYSTEM: Testability Handbook*, dated February 1992. In addition, that document provides the following general guidance regarding testability and diagnostics.

APPENDIX C

Redundancy - Built-in-Test (BIT) can be implemented by repeating the functional circuitry (the redundancy) to be tested by BIT. The same functional signal(s) is input into the redundant element and Circuit Under Test (CUT). Therefore, the circuitry of the CUT exists twice in the design and the outputs can be compared. If the output values are different and their difference exceeds a limit (analog circuits), then a fault exists. Due to the expense of this technique, redundant BIT design is usually implemented only in critical functions

An example of a BIT design using redundancy is shown in Figure C-1. In this example, an analog circuit is repeated and the difference between the output levels is compared. If the difference exceeds a predefined threshold, then a fault signal is generated and latched.

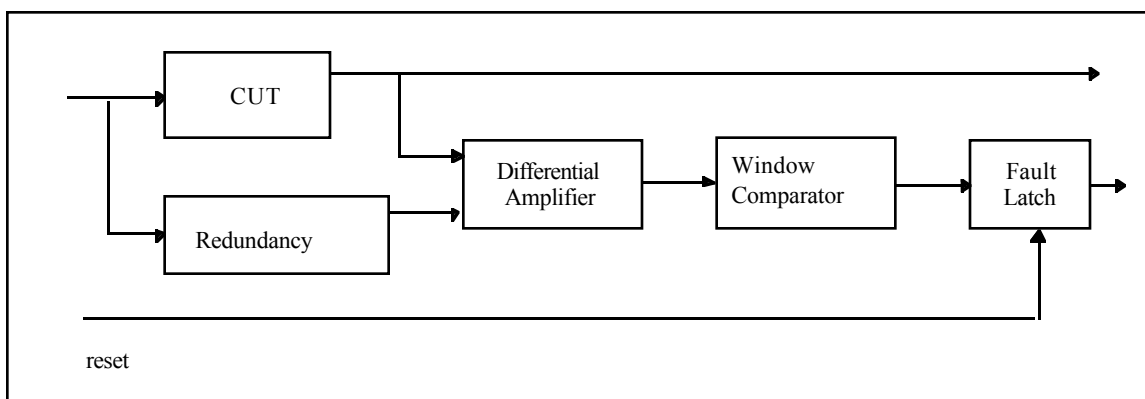

FIGURE C-1. Redundancy BIT (source: RADC-TR-89-209, Vol. II).

Wrap-around BIT - Wrap-around BIT requires and tests microprocessors and their input and output devices. During test, data leaving output devices is routed to input devices of the module. The BIT routine is stored in on-board read-only memory (ROM). Wrap-around can be done by directing output signals from the processor back to the input signals and verifying the input signal values. Wrap-around BIT can be applied to both digital and analog signals concurrently. An example of wrap-around BIT testing both analog and digital devices is shown in Figure C-2. In this example, during normal operation processor outputs are converted from digital to analog outputs and analog inputs are converted to digital input signals. When the BIT is initiated, the analog outputs are connected to the analog inputs and the signals are verified by the processor.

The remainder of RL-TR-92-12, Volume I, provides detailed guidance on testability design techniques and structured test techniques for the categories of part types and technologies shown in Table C-III on the following page.

In addition to the practical design guide information found in RL-TR-92-12, Volume I, Appendix B of MIL-HDBK-2165, *Testability Program For Systems And Equipments*, provides an Inherent testability checklist. It is reprinted here, in a slightly different format, as Table C-IV. Refer to MIL-HDBK-2165 for further guidance on testability program planning.

APPENDIX C

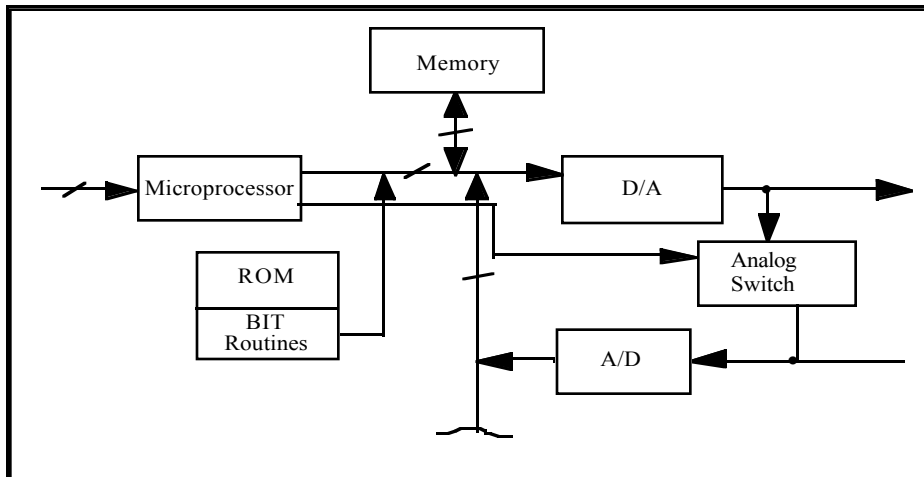

FIGURE C-2. Wrap-around BIT (source: RADC-TR-89-209, Volume II).

TABLE C-III. Categories of Part Types and Technologies from RL-TR-92-12, Volume I.

<ul style="list-style-type: none"> • Digital Guidelines <ul style="list-style-type: none"> * Initialization * Visibility * Controllability * Functional Elements • Microprocessors and Support Chips <ul style="list-style-type: none"> * Microprocessor/Microcontrollers * Complex Instruction Set Computer (CISC) Microprocessors * Reduced Instruction Set Computer (RISC) Microprocessors 	<ul style="list-style-type: none"> • Very Large Scale Integration (VLSI) <ul style="list-style-type: none"> * LSI Based CCAs * Visibility * Controllability * Synchronization * Initialization * Partitioning * Self-tests * Device Standardization * Standard LSI/VLSI Guidelines * Structured LSI/VLSI Guidelines 	<ul style="list-style-type: none"> • High Power Guidelines <ul style="list-style-type: none"> * Regulated Power Supplies * Corona and Electric Arcing * High Voltage/High Current Circuits * High Power * General High Power Module Techniques • Electro-Optic Guidelines <ul style="list-style-type: none"> * Human/Hardware Interaction * Hydraulic UUTs * Pneumatic UUTs * Electric Drive UUTs * General Mechanical Components
<ul style="list-style-type: none"> • Transputers (INMOS CORP) <ul style="list-style-type: none"> * Bit Slice Microprocessor * Single Chip/Embedded Microcontrollers * Digital Signal Processors (DSP) and Others * Future Processors (General) * Microprocessor Support Chip Testability • Structured Design-For-Test Techniques <ul style="list-style-type: none"> * Structured LSI/VLSI <ul style="list-style-type: none"> ◇ Level Sensitive Scan Design ◇ Scan Path ◇ Scan/Set Logic ◇ Random Access Scan ◇ Built-in Logic Block Observation (BILBO) * Boundary Scan * Scan/Boundary Scan Testability Guidelines 	<ul style="list-style-type: none"> • Memory and Programmable <ul style="list-style-type: none"> * General Memory Guidelines * Memory and PLD Techniques and Guidelines * Generic Memory Techniques and Guidelines * Software Techniques Used for Memory Testability • Analog Testability Guidelines <ul style="list-style-type: none"> * General Guidelines * Specific Guidelines <ul style="list-style-type: none"> ◇ Low Frequency Linear and Pulse Circuits ◇ Data Conversion Circuits ◇ Monitoring and Control Circuit 	<ul style="list-style-type: none"> • Incircuit Test and Testability <ul style="list-style-type: none"> * Philosophy * Advantages and Limitations * ICT Program Generation * Testability Problems * Incircuit Testability Rules * BIT/BITE * Impulsive UUTs * Software Testability Guidelines * General "Other" Guidelines • High Frequency Guidelines <ul style="list-style-type: none"> * Linear and Pulse Circuits * Microwave Guidelines * MMIC Guidelines

APPENDIX C

TABLE C-IV. Inherent Testability Checklist.

Mechanical Design Checklist (for electronic designs)	
<ul style="list-style-type: none"> • Is a standard grid layout used on boards to facilitate identification of components? • Are the number of I/O pins in an edge connector or cable connector compatible with the I/O capabilities of the selected test equipment? • Are connector pins arranged such that the shorting of physically adjacent pins will cause minimum damage? • Is the design free of special set-up requirements (special cooling) which would slow testing? • Does the item warm up in a reasonable amount of time? • Has provision been made to incorporate a test-header connector into the design to enhance ATE testing of surface-mounted devices? 	<ul style="list-style-type: none"> • Is defeatable keying used on each board so as to reduce the number of unique interface adapters required? • Is each hardware component clearly labeled? • Are all components oriented in the same direction (pin 1 always in same position)? • Does the board layout support guided-probe testing techniques? • When possible, are power and ground included in the I/O connector or test connector? • Have test and repair requirements impacted decisions on conformal coating? • Is enough spacing provided between components to allow for clips and test probes?
Partitioning Checklist (for electronic functions)	
<ul style="list-style-type: none"> • Is each function to be tested placed wholly upon one board? • Within a function, is the size of each block of circuitry to be tested small enough for economical fault detection and isolation? • Is the number of power supplies required compatible with the test equipment? • If more than one function is place on a board, can each be tested independently? 	<ul style="list-style-type: none"> • If required, are pull up resistors located on same board as the driving component? • Is the number and type of stimuli required compatible with the test equipment? • Within a function, can complex digital and analog circuitry be tested independently? • Are analog circuits partitioned by frequency to ease tester compatibility? • Are elements which are included in an ambiguity group placed in the same package?
Test Control Checklist	
<ul style="list-style-type: none"> • Are connector pins not needed for operation used to provide test stimulus and control from the tester to internal nodes? • Is it possible to disable on-board oscillators and drive all logic using a tester clock? • Is circuitry provided to by-pass any (unavoidable) one-shot circuitry? • In microprocessor-based systems, does the tester have access to the data bus, address bus and important control lines? • Are active components, such as demultiplexers and shift registers, used to allow the tester to control necessary internal nodes using available input pins? • Can circuitry be quickly and easily driven to a known initial state? (master clear, less than N clocks for initialization sequence)? 	<ul style="list-style-type: none"> • Can long counter chains be broken into smaller segments in test mode with each segment under tester control? • Can feedback loops be broken under control of the tester? • Are test control points included at those nodes which have high fan-in (test bottlenecks)? • Are redundant elements in design capable of being independently tested? • Can the tester electrically partition the item into smaller independent, easy-to-test segments? (placing tri-state element in a high impedance state). • Have provisions been made to test the system bus as a stand-alone entity? • Are input buffers provided for those control point signals with high drive capability requirements?
Parts Selection Checklist	
<ul style="list-style-type: none"> • Is the number of different part types the minimum possible? • Is a single logic family being used? If not, is a common signal level used for interconnections? 	<ul style="list-style-type: none"> • Have parts been selected which are well characterized in terms of failure modes? • Are the parts independent of refresh requirements? If not, are dynamic devices supported by sufficient clocking during testing?

APPENDIX C

TABLE C-IV. Inherent Testability Checklist. (continued)

Test Access	
<ul style="list-style-type: none"> • Are unused connector pins used to provide additional internal node data to the tester? • Are test access points placed at those nodes which have high fan-out? • Are active components, such as multiplexers and shift registers, used to make necessary internal node test data available to the tester over available output pins? • Are signal lines and test points designed to drive the capacitive loading represented by the test equipment? • Are buffers employed when the test point is a latch and susceptible to reflections? 	<ul style="list-style-type: none"> • Are all high voltages scaled down within the item prior to providing test point access so as to be consistent with tester capabilities? • Are test points provided such that the tester can monitor and synchronize to onboard clock circuits? • Are buffers or divider circuits employed to protect those test points which may be damaged by an inadvertent short circuit? • Is the measurement accuracy of the test equipment adequate compared to the tolerance requirement of the item being tested?
Analog Design Checklist	
<ul style="list-style-type: none"> • Is one test point per discrete active stage brought out to the connector? • Are circuits functionally complete without bias networks or loads on some other UUT? • Is a minimum number of complex modulation or unique timing patterns required? • Are response rise time or pulse width measurements compatible with test capabilities? • Does the design avoid or compensate for temperature sensitive components? • Is each test point adequately buffered or isolated from the main signal path? • Is a minimum number of multiple phase-related or timing-related stimuli required? 	<ul style="list-style-type: none"> • Are stimulus frequencies compatible with tester capabilities? • Are stimulus amplitude requirements within the capability of the test equipment? • Does the design allow testing without heat sinks? • Are multiple, interactive adjustments prohibited for production items? • Is a minimum number of phase or timing measurements required? • Do response measurements involve frequencies compatible with tester capabilities? • Does the design avoid external feedback loops? • Are standard types of connectors used?
RF Design Checklist	
<ul style="list-style-type: none"> • Do transmitter outputs have directional couplers or similar signal sensing/attenuation techniques employed for BIT or off-line test monitoring purposes, or both? • Has provision been made in the off-line ATE to provide switching of all RF stimulus and response signals required to test the subject RF UUT? • Are the RF test input/output access ports of the UUT mechanically compatible with the off-line ATE I/O ports? • Have adequate testability (controllability/observability) provisions for calibrating the UUT been provided? • If an RF transmitter is to be tested utilizing off-line ATE, has suitable test fixturing (anechoic chamber) been designed to safely test the subject item over its specified performance range of frequency and power? • Have all RF testing parameters and quantitative requirements for these parameters been explicitly stated at the RF UUT interface for each RF stimulus/response signal to be tested? • Has the UUT/ATE RF interface been designed so that the system operator can quickly and easily connect and disconnect the UUT without special tooling? 	<ul style="list-style-type: none"> • Have RF compensation procedures and data bases been established to provide calibration of all stimulus signals to be applied and all response signals to be measured by BIT or off-line ATE to the RF UUT interface? • Have suitable termination devices been employed in the off-line ATE or BIT circuitry to accurately emulate the loading requirements for all RF signals to be tested? • Does the RF UUT employ signal frequencies or power levels in excess of the core ATE stimulus/measurement capability? If so, are signal converters employed within the ATE to render the ATE/UUT compatible? • Has the RF UUT been designed so that repair or replacement of any assembly or subassembly can be accomplished without major disassembly of the unit? • Does the off-line ATE or BIT diagnostic software provide for compensation of UUT output power and adjustment of input power, so that RF switching and cable errors are compensated for in the measurement data?

APPENDIX C

TABLE C-IV. Inherent Testability Checklist. (continued)

Electro-optical (EO) Design Checklist	
<ul style="list-style-type: none"> • Have optical splitters/couplers been incorporated to provide signal accessibility without major disassembly? • Has temperature stability been incorporated into fixture/UUT design to assure consistent performance over a normal range of operating environments? • Have optical systems been functionally allocated so that they and associated drive electronics can be independently tested? • Are the ATE system, light sources, and monitoring systems of sufficient wave-length to allow operation over a wide range of UUTs? • Does the test fixturing intended for the off-line test present the required mechanical stability? • Is there sufficient mechanical stability and controllability to obtain accurate optical registration? • Can requirements for boresighting be automated or eliminated? 	<ul style="list-style-type: none"> • Do monitors possess sufficient sensitivity to accommodate a wide range of intensities? • Can optical elements be accessed without major disassembly or realignment? • Do they possess sufficient range of motion to meet a variety of test applications? • Has adequate filtering been incorporated to provide required light attenuation? • Can all modulation models be simulated, stimulated, and monitored? • Can targets be automatically controlled for focus and aperture presentation? • Do light sources provide enough dynamics over the operating range? • Do test routines and internal memories test pixels for shades of gray? • Are optical collimators adjustable over their range of motion via automation?
Digital Design Checklist	
<ul style="list-style-type: none"> • Does the design contain only synchronous logic? • Does the design avoid resistance capacitance one-shots and dependence upon logic delays to generate timing pulses? • Is the design free of WIRED-ORs? • Will the selection of an unused address result in a well defined error state? • Are all clocks of differing phases and frequencies derived from a single master clock? • Is the number of fan-outs for each board output limited to a predetermined value? Are latches provided at the inputs to a board in those cases where tester input skew could be a problem? • For multilayer boards, is the layout of each major bus such that current probes or other techniques may be used for fault isolation beyond the node? 	<ul style="list-style-type: none"> • If the design incorporates a structured testability design technique (scan path, signature analysis), are all the design rules satisfied? • Is the number of fan-outs for each internal circuit limited to a predetermined value? • Are all memory elements clocked by a derivative of the master clock? (Avoid elements clocked by data from other elements.) • Does the design include data wrap-around circuitry at major interfaces? • Is a known output defined for every word in a read only memory? • Are sockets provided for microprocessors and other complex components? • Does the design support testing of "bit slices"? • Do all buses have a default value when unselected?

APPENDIX C

TABLE C-IV. Inherent Testability Checklist. (continued)

Built-in-Test (BIT) Checklist	
<ul style="list-style-type: none"> • Can BIT in each item be exercised under control of the test equipment? • Does the BIT use a building-block approach (all inputs to a function are verified before that function is tested)? • Does on-board ROM contain self-test routines? • Does BIT include a method of saving on-line test data for the analysis of intermittent failures and operational failures which are non-repeatable in the maintenance environment? • Is the additional volume due to BIT within stated constraints? • Does the allocation of BIT capability to each item reflect the relative failure rate of the items and the criticality of the items' functions? • Are the data provided by BIT tailored to the differing needs of the system operator and the system maintainer? 	<ul style="list-style-type: none"> • Is the failure latency associated with a particular implementation of BIT consistent with the criticality of the function being monitored? • Is the test program set designed to take advantage of BIT capabilities? • Does building-block BIT make maximum use of mission circuitry? • Is the self-test circuitry designed to be testable? • Is the predicted failure rate contribution of the BIT circuitry within stated constraints? • Is the additional power consumption due to BIT within stated constraints? • Are BIT threshold values, which may require changing as a result of operational experience, incorporated in software or easily-modified firmware? • Are on-board BIT indicators used for important functions? Are BIT indicators designed such that a BIT failure will give a "fail" indication?
Built-in-Test (BIT) Checklist (continued)	
<ul style="list-style-type: none"> • Is sufficient memory allocated for confidence tests and diagnostic software? • Are BIT threshold limits for each parameter determined as a result of considering each parameter's distribution statistics, the BIT measurement error and the optimum fault detection/false alarm characteristics? • Is BIT optimally allocated in hardware, software, and firmware? • Have means been established to identify whether hardware or software has caused a failure indication? 	<ul style="list-style-type: none"> • Is the additional weight due to BIT within stated constraints? • Is the additional part count due to BIT within stated constraints? • Is processing or filtering of BIT sensor data performed to minimize BIT false alarms? • Does mission software include sufficient hardware error detection capability?
Performance monitoring Checklist	
<ul style="list-style-type: none"> • Have critical functions been identified (by FMECA) which require monitoring for the system operation and users? • Have interface standards been established that ensure the electronic transmission of data from monitored systems is compatible with centralized monitors? 	<ul style="list-style-type: none"> • Has the displayed output of the monitoring system received a human engineering analysis to ensure that the user is supplied with the required information in the best useable form?
Diagnostic Capability Integration	
<ul style="list-style-type: none"> • Have vertical testability concepts been established, employed, and documented? • Has the diagnostic strategy (dependency charts, logic diagrams) been documented? 	<ul style="list-style-type: none"> • Has a means been established to ensure compatibility of testing resources with other diagnostic resources at each level of maintenance (technical information, personnel, and training)?
Mechanical Systems Condition Monitoring (MSCM) Checklist	
<ul style="list-style-type: none"> • Have MSCM and battle damage monitoring functions been integrated with other performance monitoring functions? 	<ul style="list-style-type: none"> • Are preventive maintenance monitoring functions (oil analysis, gear box cracks) in place? • Have scheduled maintenance procedures been established?

APPENDIX C

TABLE C-IV. Inherent Testability Checklist. (continued)

Sensors Checklist	
<ul style="list-style-type: none"> • Are pressure sensors placed very close to pressure sensing points to obtain wideband dynamic data? • Has the selection of sensors taken into account the environmental conditions under which they will operate? 	<ul style="list-style-type: none"> • Have procedures for calibration of sensing devices been established? • Has the thermal lag between the test media and sensing elements been considered?
Test Requirements Checklist	
<ul style="list-style-type: none"> • Has a "level of repair analysis" been accomplished? • For each maintenance level, has a decision been made for each item on how BIT, ATE, and General Purpose Electronic Test Equipment (GPETE), will support fault detection and isolation? 	<ul style="list-style-type: none"> • For each item, does the planned degree of testability design support the level of repair, test mix, and degree of automation decisions? • Is the planned degree of test automation consistent with the capabilities of the maintenance technician?
Test Data Checklist	
<ul style="list-style-type: none"> • Do state diagrams for sequential circuits identify invalid sequences and indeterminate outputs? • For computer-assisted test generation, is the available software sufficient in terms of program capacity, fault modeling, component libraries, and post-processing of test response data? • If a computer-aided design system is used for design, does the CAD data base effectively support the test generation process and test evaluation process? • Is the tolerance band known for each signal on the item? 	<ul style="list-style-type: none"> • Are testability features included by the system designer documented in the Test Requirement Document (TRD) in terms of purpose and rationale for the benefit of the test designer? • For large scale ICs used in the design, are data available to accurately model the circuits and generate high-confidence tests? • Are test diagrams included for each major test? Is the diagram limited to a small number of sheets? Are inter-sheet connections clearly marked?

C.2.2.2 Safing and Arming

Failure to properly "safe" or "arm" any of the numerous devices containing safe/arm provisions has resulted in loss of life, loss of the vehicle, wide-ranging personnel injury, wide-ranging vehicle/ground equipment damage, non-military liability damage, damage to facilities, ground aborts, air aborts, and a host of equipment/personnel incidents. The following exemplifies some of the major cases:

Failure to "Safe":

- Canopy Ground Jettison
- Ground Release/Jettison of Weapons/Stores
- Gun/Missile Firing on Ground
- Uncommanded Extension/Retraction of Tail Hook
- Flight Control Surface/Ground Equipment Contact Damage
- Folding Wing Contact Damage with Ground Equipment, other Aircraft, or Facility Structure
- Seat Ground Ejection
- Collapse/Retraction of Nose or Main Landing Gear
- Uncommanded Opening/Closing of Weapon Bay Doors During Ground maintenance/Handling
- Flight Control Surface/Access Door Contact Damage
- Flight Control Damage due to Absence of Gust/Control Locks

APPENDIX C

Failure to "Arm":

- Inability to Jettison Canopy
- Inability to Fire/Drop/Launch Weapons (Air/Mission Abort)
- Failure to Retract Landing Gear (Air Abort)
- Inability to Extend Tail Hook
- Inability to Eject
- Inability to Jettison External Store/Pylon
- Inability to Retract Speed Brake (Ground Abort)
- Inability to Extend Wings

Improper Handling/Stowage of Safe/Arm Devices:

- Engine Foreign Object Damage (FOD)
- FOD in Gun System, Throttle Controls, Escape System Linkage
- FOD/Damage from Pins/Covers in Aft Cockpit when Flying Solo
- Flight Control FOD
- Damage/FOD in Bay Containing Pin Stowage Provisions
- Aircraft Loss Due to Control Locks

List of Guidelines

Guideline Numbers	Guideline
A-01	Seal equipment bays and compartments against the environmental elements including all types of servicing fluids used for the vehicle, all types of anti-ice and de-ice fluids, and all types of fluids used for chemical, biological, or nuclear decontamination
A-02	Equipment bay and compartment structure should be bonded, co-cured, welded, machined, or combinations thereof to eliminate or minimize the use of mechanical fasteners.
A-03	All equipment bay and compartment structural flanges and stiffeners should be external to the compartment to maximize the volume available for equipment installation and arrangement.
A-04	Use stiffening beads in lieu of flanges to the maximum extent to enhance compartment volume and simplify repairs. Stiffening beads should have the convex surface toward the compartment to eliminate fluid traps.
A-05	Keep all machined compartment frames, webs, and closure panels to a constant thickness (e.g., not stepped or tapered) to ease simplicity of fluid or electrical penetrations and ease and simplicity of structural repair.
A-06	Hardpoints (structural attachment and load bearing areas) within a compartment to assist in equipment mounting or support should not be integral with the machined part. Hardpoints should be parasitic to enable quick repair in case of wear or damage in lieu of precise ream/bush repair typical of machined hardpoints.
A-07	Paint equipment bay and compartment interiors a high gloss white to maximize lighting reflectivity, visibility, and rapid leak detection capability.
A-08	Plumbing penetrations into a compartment should not be on a vertical axis due to difficulty in making or breaking vertically-oriented connections. When compartment access is from the bottom, vertically-oriented connections can allow fluid to leak onto the maintainer. When access is from the top, such connections can allow foreign matter to enter the line. Use horizontal penetrations whenever possible.
A-09	Any heat or temperature sensitive structure within a compartment should contain heat-sensitive tape or appropriate heat sensor for easy indication of over-temperature excursions.
A-10	Provide a sufficient number of compartment fluid drains to ensure fluid drainage for varying aircraft static attitudes and varying terrain slopes for ground vehicles.
A-11	Locate compartment electrical penetrations close to the access opening for ease of sight, probing, repair, and to eliminate fluid soaking, wicking, or contamination.
A-12	Locate compartment electrical penetrations far enough from the access opening to prevent damage resulting from improper (over-length) panel fasteners.
A-13	Two-sided or two-surfaced access should not be required for access to equipment interfaces and hardpoints. The term two-sided infers top/bottom, left/right, front/back, or combinations thereof.
A-14	Do not locate nutplates or gang channels in inaccessible areas that would require extensive disassembly or equipment removal to gain access.
A-15	Locate tie-down attachment points such that tie-down chains, straps, or cables do not prevent or restrict normal servicing, weapon loading, or safe/arm functions.
A-16	Structural design should provide good access to corrosion-prone areas for inspection and treatment.

List of Guidelines (Cont'd)

Guideline Numbers	Guideline
A-17	All structural fasteners in an access door or panel should be of identical grip and diameter. In rare cases where this is not possible, fasteners of different grip must have different diameters to prevent a shorter fastener being substituted for the correct, longer fastener.
A-18	Use transparent windows, quick-opening covers, or openings without any cover to permit quick visual inspections where needed.
AA&S-01	Flush mounted antennas, sensors, and air data devices should have a good color contrast to surrounding structure when located in walkway areas.
AA&S-02	Closure and sealing of cavities, compartments, and wells for retractable antennas should be mechanized to function as part of the extend and retract cycle.
AA&S-03	Closure and sealing of cavities, compartments, and wells for retractable antennas should be maintained when antennas are not installed without need for ancillary measures or equipment.
AA&S-04	LO antennas should be designed to be tolerant of accumulations of grime or dirt without degrading performance or biasing the BIT/fault isolate performance.
AA&S-05	Multi-function antennas, arrays, and sensors located in leading edges should be modularized to reduce vehicle downtime through simplified replacement of a faulty module.
AA&S-06	Moveable flaps or slats containing integral antennas, arrays, or sensors should be interchangeable to provide the option for on-vehicle or off-vehicle repair.
ACS-01	Design air cushion skirt surfaces to be highly resistant to high velocity blowing sand and stones.
ACS-02	Design skirt surfaces to the same operational and environmental criteria as that identified for low observable surfaces.
ACS-03	Select materials for the skirt surface so that bonded repairs can be used for punctures and tears across a wide temperature spectrum/humidity index without relying on special facilities or equipment.
ACS-04	Incorporate rip-stop methodology in skirt construction to limit tears and rips and to prevent tear propagation.
ACS-05	Incorporate a color-coded interply in skirts to readily identify the maximum abrasion limit.
ACS-06	Do not try to achieve high reliability by requiring frequent visual inspections or scheduled replacement at predetermined calendar or operating hour intervals.
ACS-07	Design skirt repair kits and select materials for the kits so they are not subject to a predetermined shelf-life or special storage requirements.
ACS-08	Design all elements making up the air cushion control system so they are capable of sustained operations in salt air/water environments.
ACS-09	Employ control by wire or control by light technology to eliminate complex control mechanisms and associated maintenance and support.
ACS-10	Ensure all diagnostic and prognostic logic, intelligence, and status type informational data are storable and viewable within the crew station.
ACS-11	Provide crew station personnel with the capability to manually initiate selective BIT and interrogate the prognostics system without interrupting the full-time or periodic BIT routines.

List of Guidelines (Cont'd)

Guideline Numbers	Guideline
ARM-01	For an aircraft, the fuselage lower shear moldline should be no less than 38" above the ground when external weapons only will be carried on the fuselage.
ARM-02	For an aircraft, the fuselage lower shear moldline should be no less than 50" above the ground when internal weapons will be carried in the fuselage and weapon bay door widths exceed 22".
ARM-03	Locate fuselage weapon bays a minimum of 18" from the nose landing gear and main landing gear of an aircraft.
ARM-04	No single weapon/store mounted on a transporter should intrude into the service/turnaround envelope of another station.
ARM-05	All servicing and turnaround functions (including movement envelopes) should be outside the gun firing envelope.
ARM-06	The relationship of the nose landing gear to the main landing gear should not restrict the positioning of weapon transporters under the fuselage of an aircraft.
ARM-07	The design of weapon and store ejectors and launchers should not require scheduled servicing, maintenance, or inspection requirements prior to upload of the weapon or store.
ARM-08	Weapon and store ejectors containing arming solenoids should ensure the solenoids can be rapidly replaced while installed.
ARM-09	Weapon and store ejectors containing adjustable pitch control devices should ensure devices are easily accessible and adjustments are Murphy-free.
ARM-10	Weapon and store stations should be located to ensure vehicle ballasting will not be required under any combination of weapon/store configurations.
ARM-12	Missile and weapon cooling provisions should have the capability to be serviced in-situ or rapidly replaced as a pre-charged assembly.
ARM-13	Do not locate magnesium fittings or structure in the motor plume of rail-launched missiles.
BIT-01	During design of the BIT, use worst-case stress analysis to ensure that any circuit failures induced by temperature extremes, tolerance build-up, power supply variations, and combinations thereof are identified.
BIT-02	Ensure that BIT system thresholds are consistent with those across the system, subsystem, item, module, and piece-part levels to prevent excessive numbers of Cannot Duplicate (CND) and Retest OK (RTOK) events from occurring.
BIT-03	The degree of BIT required or proposed should be based on the respective failure rates and the appropriate FMECA at all equipment indenture levels.
BIT-04	Limit the amount of data that is recorded to a manageable size by: <ul style="list-style-type: none"> - Limiting the number of signals that are monitored - Limiting the maximum sampling rate - Reducing the time span over which data is accumulated - Restricting the type of data accumulated
BIT-05	Incorporate testability design features as an integral part of equipment preliminary design process.
BIT-06	Mission critical functions should be monitored by BIT.
BIT-07	Set BIT tolerances to maximize fault detection and minimize false alarm rate in the expected operating environment.

List of Guidelines (Cont'd)

Guideline Numbers	Guideline
BIT-08	Design BIT fault detectors to accommodate the needs of operator maintenance personnel.
BIT-09	Use concurrent BIT to monitor system critical functions.
BIT-10	Design the BIT and BITE so that no fault or failure within the BIT or BITE will degrade, disrupt, or fail the system being monitored.
BIT-11	In the area of software design and test responsibility, the responsibility for the design and development of verification testing of an end item (e.g., digital filter) should reside with the same engineer(s).
BIT-12	Define stimuli and response data for each diagnostic test at the system/subsystem level. The same data should be planned for use both in factory testing as well as in field maintenance of the equipment. These data minimize the amount of unique software to be written.
BIT-13	Provide for manual control to test sequences, so that the test can be selected individually, and appropriate test combinations can be executed at the operator's discretion.
BIT-14	Provide access to all BIT control and status signals at module connector pins. This will enable ATE to directly connect to BIT circuitry.
BIT-15	Incorporate complete BIT functions and BITE on module. If only a portion of the BIT routine or BITE circuitry exists on the module, then ATE cannot utilize the BIT routine without providing the missing BIT functions.
BIT-16	Critical voltages should be visually monitored by sending the voltage signals to visible LEDs.
BIT-17	BIT failures should be latched on the module. This makes it easier for the system or ATE to poll the error bit at any time.
BIT-18	If many BIT routines exist on a module, then ATE should have access and the ability to control each routine individually.
BIT-19	Design BIT to have a very low false alarm rate; otherwise BIT will not be an effective maintenance tool. As a goal, the false alarm rate should be 1% or less.
BIT-20	The BIT should be mechanized so that when a piece of equipment is not installed in a subsystem or the product, a failure will not be indicated.
BIT-21	The failure detection function should provide the equipment operator with a go/no-go indication of equipment readiness.
BIT-22	The BIT should be designed so that auxiliary test devices or external equipment are not needed for daily and other regular checks.
BIT-23	Design BIT so it is initiated automatically upon equipment power-up.
BIT-24	Test points should be functionally grouped together and clearly labeled for convenience and ease of maintenance.
BIT-25	Equipment should not require manual probing to fault isolate.
BIT-26	Locate routinely used test points so they are accessible without removing or disassembling other equipment
BIT-27	Periodic and initiated BIT should detect at least 98% of all failures and isolate a minimum 99% of those failures detected to a single LRU or WRA.
BIT-28	Design BIT to have the same level of EMI protection as the system or equipment being monitored.
BIT/BITE-01	Design to keep false alarm rates below 1%. Higher false alarm rates can limit the effectiveness of BIT as a maintenance tool.
BIT/BITE-02	Design EMI protection to eliminate finger type EMI contact devices.
C-01	Avoid swivel type connectors and fittings for air, fuel, or hydraulic line interfaces due to their history of low reliability.

List of Guidelines (Cont'd)

Guideline Numbers	Guideline
C-02	Provide spacing between parallel plumbing runs so that in-line couplings can be replaced without removing lines or disconnecting any line support devices.
CARGO-01	<p>Ground vehicles with storage bays or compartments accessible from outside the vehicle should:</p> <ul style="list-style-type: none"> - Have the door sill located no lower than knee height to accommodate a wide range of percentiles while standing. - Ensure door handles are flush with outer surface to protect personnel. - Contain goose neck hinges to protect the hinge from the elements. - Contain peripheral door seals that will protect against blowing sand entry at 50 mph. - Ensure door can be opened with transport tie downs installed. - Ensure door opening envelope does not intrude into the opening envelope of an adjacent door. - Contain simple sheet metal hold-open spring or mechanism. - Ensure floor of bay or compartment is flush with sill to simplify cleanup and drainage. - Ensure door unlocking and opening mechanism can be actuated by a 95 percentile male hand while wearing arctic gloves. - Contain 15 percent added volume for density growth.
CARGO-02	<p>Ground vehicles with small exterior storage bays or compartments containing emergency equipment or supplies should:</p> <ul style="list-style-type: none"> - Be located at chest height of the 50 percentile male. - Contain unlatching mechanisms activated by pushing inward on the door. - Meet all other generic bay and compartment requirements.
CBR-01	Orient all vehicle liquid servicing fittings to ensure fluids will not come in contact with protective garb during connect/disconnect activities.
CBR-02	Ensure vehicle overboard passive liquid drains are clearly marked or visible to enable personnel to remain clear of area.
CBR-03	Design fuel cell drains so they can not be activated in a manner that would allow fuel to come in contact with a protected hand.
CBR-04	Design emergency ingress provisions so they can be activated by a 95 percentile male wearing full protective chemical or biological protection gear.
CBR-05	Size rescue doors, panels, and "cut here" areas to accommodate the 95 percentile shoulder width wearing full protective chemical or biological protection gear.
CBR-06	Consider the reduction in peripheral vision resulting from wearing chemical or biological protection gear when designing intended fire paths and crash rescue paths into a vehicle.
CC-01	Use fiber-optic technologies in preference to conventional interconnect concepts to reduce the number of interconnects/interfaces, reduce manufacturing and ownership costs, and significantly improve R&M.
CC-02	Standardize connector and wire types to improve testability and logistic support. Keep the number of "different" standard connectors to a minimum. Use the same connector type keyed differently where possible.
CC-03	Provide clearance around connectors for engagement/disengagement of cables and proper connector orientation under anticipated environmental conditions (e.g., bare hand of 50 percentile male in an enclosed or protected environment and a gloved hand of a 50 percentile male in an open or unprotected environment).

List of Guidelines (Cont'd)

Guideline Numbers	Guideline
CC-04	Use quick release cables and locate cables to make removal and replacement easy and to avoid having to remove one cable to gain access to another. Provide adequate space for cables, including sleeving and tie-downs, and adequate service loops for ease of assembly/disassembly
CC-05	Orient and space connectors to allow a sufficient grip on the connector for cable or wire extraction without fear of using the wiring or cable for additional leverage.
CC-06	Label, and where possible color code, each wire in a harness or cable to facilitate tracking from origin to termination. Each wire, cable, and coax-to-connector interface should be provided with a source of identification to aiding trouble shooting, repair, or modification. Marking the cable designator on the cable along with bar codes is also recommended.
CC-07	Do not manufacture or dress connectors containing more than 25 wires or cables as a single integrated harness. Group the wires or cables into runs of no more than 25 wires or cables each. In addition to making trouble shooting and repair easier, this approach help avoid large bend radii, thereby simplifying routing, packaging, and stowage.
CC-08	Standardize connector pin assignments for power, ground, and other frequently used signals.
CC-09	Locate LRU/subsystem critical nodes (and or test points) so they are accessible from a connector to prevent the need for internal LRU probing or access.
CC-10	Avoid hidden cables. Visually inspecting and tracing all assembly cables rather than having hidden cables (such as behind other cables or even LRUs) allows for a quick system and cable integrity check which aids in overall system integrity and debug. This also implies quick access for manipulative actions.
CC-11	Orient spare wires and cable pigtails along the outer diameter or periphery of connectors to make access easier.
CC-12	Build up and assemble straight and angle connector shells or back shells in a manner that ensures that wire or cable strain or wear is not possible.
CO-01	Design automated systems and programs with provisions to enable "stop test" and "resume" without the need to cycle back or repeat the entire test.
CO-02	In the event of program loss or hang-up, automated systems and programs should have provisions for reverting to manual test and operation.
CO-03	Use a test connector to provide test and maintenance bus access to all system and subsystem faults.
CO-04	Design systems and subsystems so that ATE can be used to access, read, and control internal components in concert with the test or checkout program.
CO-05	Avoid the need for costly adapters for signal communications between system, subsystems, line replaceable units (LRUs) or Weapon Replaceable Assemblies (WRAs), and ATE.
CONT-01	Control rods should use Boyd or impedance type bolts (or equivalent) to eliminate the need for cotter pins or safety wire.
CONT-02	Do not use metal control cables for vehicles that will operate in salt water or salt air environments.
CONT-03	Use control rods rather than control cables for non-complex applications and non-complex routing within the vehicle.
CONT-04	Use control cables rather than control rods for most complex applications.

List of Guidelines (Cont'd)

Guideline Numbers	Guideline
CONT-05	Route cables so that 100 percent of a cable will be viewable for inspection.
CONT-06	Design all pulleys and brackets associated with cable installations so they are accessible by a 75 percentile male hand.
CREW-01	Canopy attachment/hinge hardpoints should be located on the same structural subassembly as the canopy locking hardpoints.
CREW-02	Armor protection integrated with the vehicle structure should be given preference over parasitic armor.
CREW-03	In rare cases where armor is parasitic, armor should be interchangeable and easily installed.
CREW-04	Avoid wiring, coax, and plumbing penetrations through the floor of crew cabs, operators' compartments, crew stations, cockpits, and passenger compartments.
CREW-05	Structural instrument panels, dashboards, and control panels should be modularized for easy and adequate access to all interfaces, to simplify manufacturing, and to reduce maintenance-induced problems.
CREW-06	Film magazines, tapes, and removable modules should permit considerable handling without reliance on special support equipment protection.
CREW-07	Electronic and photosensitive storage media should withstand the adverse environment created by ground, flightline, or shipboard electromagnetic fields and light sources.
CREW-08	Data storage media containers and modules should be capable of chemical and biological decontamination processes.
CREW-09	Crew and operator station cassettes or magazines should be capable of being removed and installed with one hand while the operator or air crew is seated and strapped in.
CREW-10	Design cameras, recorders, and sensors to be fully interchangeable and quickly replaceable.
CREW-11	Design cameras, lenses, reconnaissance pods, aiming devices, and related equipment so they can be reconfigured by one individual.
CREW-12	Requirements for boresighting should not be part of the design or integration.
CREW-13	Provide storage provisions in each vehicle type (ground and airborne) to store extra tapes, modules, canisters, cassettes, as appropriate to the intended vehicle use/mission.
D&V-01	The geometric aspects of structural design and interfaces should not result in any natural bathtubs.
D&V-02	Closed structural sections subject to condensation or fluid migration should contain drainage provisions.
D&V-03	Crew cabs, operators' compartments, crew stations, cockpits, and passenger compartments should be subject to the same corrosion prevention measures as the exteriors of the vehicles. Low points, pockets, and related fluid collection points within should be provided with low point drains.
EC-01	A threaded electrical connector should contain integral locking mechanisms and visual indications that the connector is properly seated and locked.
EC-02	An electrical connector requiring less than one full turn to connect or disconnect should contain integral locking mechanisms and visual indications that the connector is properly seated and locked.
EC-03	A push-pull electrical connector (excluding rack-and-panel type) should contain integral locking features and visual indication that the connector is properly seated and locked.

List of Guidelines (Cont'd)

Guideline Numbers	Guideline
EC-04	All electrical connectors should be keyed or asymmetrically shaped to ensure proper alignment.
EC-05	All electrical connectors should contain scoop-proof shells to ensure pin damage will not occur prior to engaging key way.
EC-06	All electrical connectors should be corrosion resistant to reduce or eliminate the need for scheduled inspections or corrosion prevention measures.
EC-07	Avoid using electrical connectors requiring any type or form of soldering.
EC-08	Locate and position electrical connectors such that all pin identification for either half can be easily seen.
EC-09	Electrical connectors selected for critical applications on ground vehicles should be both accessible and capable of being connected disconnected by a fifty percentile gloved male hand.
EC-10	Separation between grouped electrical connectors should be sufficient to ensure make or break of any connector by a fifty percentile gloved male hand. Where this is not possible, an alternate method should be used such as the use of stand-offs, long-shelled connectors alternated with standard connectors, 180-degree connectors alternated with 90-degree connectors, or innovative equivalents.
EC-11	Avoid connectors requiring potting as a method for environmental protection due to lengthy repair time and tendency for potting compound reversion.
EC-12	Electrical penetrations into a compartment should not be on a vertical axis to ensure foreign matter does not enter connector.
EC-13	Electrical, electronic, and coaxial interfaces between fixed and moveable surfaces should contain quick disconnects to simplify replacement of the moveable surface or the electronic module.
EC-14	Scoop proof connectors should be used throughout unless their use would require an increase in the volume of the aircraft, in which case deviations will be considered on an individual basis.
EC-15	The removal or replacement of electronic equipment should not require the removal of any other piece of equipment or armament.
EC-16	Select connectors so that contacts on the "live" or "hot" side of the connection are socket type rather than pin type to minimize personnel hazard and to prevent accidental shorting of live circuits.
EC-17	Whenever possible, use self-locking connector plugs of a type not requiring safety wire.
EC-18	All electric connectors should be environment resistant.
EC-19	Connectors containing fiber optic contacts should, whenever possible, be mounted on a vertical surface to prevent particle and fluid contamination.
EC-20	Use quick disconnect connectors where allowed and identify all pins on each connector.
EC-21	Locate connectors far enough apart so that they meet specified requirements.
EC-22	All connectors should be keyed differently with aligning pins that extend beyond the electrical pins. Connector pins and sockets should engage after key position is entered.
EC-23	Design connectors so that plugs are cold and receptacles are hot.
EC-24	Use electrical connectors that incorporate alignment key-ways to reduce incidents of damage due to improper engagement.

List of Guidelines (Cont'd)

Guideline Numbers	Guideline
EC-25	Use positive locking, quick disconnect electrical connectors to save man-hours, prevent foreign object damage (FOD) and decrease the chance of personal injury.
EC-26	Avoid using identical electrical connectors in adjacent areas.
ECS-01	Design so that equipment servicing status are accessible and readable from the ground level for air vehicles and from the operator's position for ground and water vehicles.
ECS-02	Do not locate equipment servicing points in crew, passenger, or operator areas.
ECS-03	Heat exchangers using hot liquids as the heat source should not be located inside the compartments used for operator, crew, or passengers.
ECS-04	Plumbing, lines, or hoses containing hot liquids, toxic gases or liquids should be external to operator, crew, or passenger stations.
ECS-05	Access, removal, and installation of all type filter elements should be possible without removing the assembly or disconnecting any filter package interfaces.
ECS-06	All electrical control, sensing, sensor, warning, caution, or signal interface and wiring should be fully BIT compatible.
ECS-07	Liquid type refrigeration compressors/packages should contain highly reliable quick disconnects to negate servicing or bleeding subsequent to replacement.
ECS-08	All liquid type refrigeration compressors and packages stocked as spares should be pre-serviced wherein the servicing is compatible with the shelf life of the unit.
ECS-09	Design control valves, both manual and powered, with a visual pointer that clearly indicates the position of the valve.
ECS-10	The power actuation source used for valves that direct or control air, gas, or liquid flow should be parasitic to the valve body to enable replacement without disturbing the integrity of the lines, ducts, or plenums.
ECS-11	Design air inlets, outlets, and exhausts to be accessible without reliance on ladders or work stands for ease of installing protective plugs or covers.
ECS-12	Design air inlets, outlets, and exhausts with screens to prevent bird or rodent entry.
ECS-13	Design air inlets, outlets, and exhausts to be meniscus-free to prevent a bathtub effect. In remote instances where this is not possible, passive drains should be provided at all low points to prevent liquid accumulation with the vehicle in its normal static attitude.
ECS-14	Instances where air inlets, outlets, and exhausts are subject to water entry, passive drains should be employed capable of handling 4" of rain per hour.
ECS-15	Locate and orient air inlets, outlets, and exhausts in a manner that prevents their use as footholds during maintenance.
ECS-16	All components contained in the systems, including all attaching brackets and supports, should use hex-head self-locking bolts for ease and simplicity of installation.
ECS-17	Do not use air ejectors due to their low reliability and susceptibility to clogging.
ECS-18	Avoid the use of insulation blankets containing polyvinyl for any application due to the dense smoke and toxic fumes if burned or subjected to high temperature bleed air leakage.

List of Guidelines (Cont'd)

Guideline Numbers	Guideline
ECs-19	Thermal blankets and covers used in ground vehicles should be replaceable.
ECs-20	Minor rips, tears, and punctures in ground vehicle thermal blankets and covers should be capable of being repaired in place.
ECs-21	Do not locate ground cooling or circulation fans that operate at high noise levels in operator, crew, or passenger compartments.
ECs-22	There should be no requirements for scheduled servicing or lubrication.
ECs-23	Intentionally left blank.
ECs-24	System design and integration and technology application should be such that requirements for torque is not required.
ECs-25	Technology, material selection, and treatments should combine to provide a corrosion-resistant system.
ECs-26	Design and integrate components whose proper operation depends on the direction of flow such that they cannot be incorrectly installed.
ECs-27	Use temperature-limiting devices with high temperature air systems to ensure no single or combination of surface wind, cross wind, ground operation or flight operation will damage windshields, canopies, windows or optics.
ECs-28	Install and orient air supply and distribution ducts so they clear all access openings and equipment removal envelopes.
EDECOM-01	Provide surface sensors on equipment located in compartments containing louvers, screens, flush inlets, or similar openings to the environment to indicate the presence of chem/bio contaminants.
EDECOM-02	Provide integral sensors (viewable from the exterior) for equipment subject to internal forced-air cooling from outside or external air to indicate the presence of contaminants.
EDECOM-03	Design equipment surfaces and structure to be compatible with all decontamination agents and methods.
EDECOM-04	Provide passive overboard drains in compartments subject to decontamination processes to void the area of contaminants.
EDECOM-05	Provide hoist, lift or transport handles for equipment requiring removal from the host vehicle for decontamination. In instances where this may not be practical, design the equipment with hardpoints for attaching parasitic carrying provisions
EG-01	Design feedback loops so that the loop can be broken during test to ensure that faults do not propagate to the point where they cannot be isolated.
EG-02	Avoid using external feedback loops requiring complex circuitry to simulate feedback I/Os.
EG-03	In rare instances when complex external feedback loops cannot be avoided, incorporate simple interruptible control points.
EG-04	Avoid long sequences of vectors to initialize or alter device outputs to minimize potential testability problems.
EG-05	Avoid the need to have test equipment generate complex, phased or time related signals.
EG-06	Test points should be located on all circuit nodes that are useful in determining the module's health.
EG-07	Test points should be designed so that functional circuitry cannot be damaged or degraded due to the routing or accidental shorting of a signal at a test point. Some type of test point isolation technique should be used (buffers, isolator, etc.).
EG-08	Test points should be easily accessed and clearly marked.
EG-09	Intentionally left blank.
EG-10	Design redundant circuits to be independently testable to ensure errors are not masked.
EG-11	To improve the probability of fault detection, avoid shorting signals together to achieve a specific test function or condition.

List of Guidelines (Cont'd)

Guideline Numbers	Guideline
EG-12	Incorporate concept for partitioning module functions to simplify test equipment or eliminate the need for ancillary test equipment..
EG-13	Design oscillators or clocks that are resident on the module to be replaceable by a signal from a connector to avoid the need to synchronize ATE to on-board signals.
ENG(G)-01	Provide access to all engine mounts for ground vehicles so that hoisting or crawling under the vehicle is not required.
ENG(G)-02	Use torque-limiting bolts or torque washers as engine mount attaching hardware to eliminate the need for torque wrenches.
ENG(G)-03	Design hard points for hoisting or positioning the engine during installation and removal to be integral to the engine and capable of hoisting and supporting a fully-built-up engine package.
ENG(G)-04	Do not use downward engine removal concepts that require jacking or hoisting of the ground vehicle.
ENG(G)-05	Use concepts for removing ground vehicle engines from the front, rear, or side rather than from overhead (using hoisting).
ENG(G)-06	The distance between the engine and firewall should ensure the access envelopes to lines, fittings, wiring, and adjustments will accommodate the 75 percentile male hand.
ENG(G)-07	The distance between the cooling fan and radiator core should ensure that access envelopes will not require removal of the core.
ENG(G)-08	The interface of the engine assembly to the engine compartment and structure should be designed to ensure all spark plugs, glo-plugs, and igniters can be replaced within 30 minutes elapsed time.
ENG(G)-09	Design all interfaces between the engine assembly and the host vehicle to be in full view of the maintainers and so that crawling under the vehicle is not required.
ENG(G)-10	Design attaching hardware for all mechanical engine-to-vehicle interfaces to be captive and with integral safeties.
ENG(G)-11	Use "torq-set" type clamps or equivalent in all cooling system hose interfaces to eliminate torque wrenches and the potential for error.
ENG(G)-12	Provide a clear and viewable access envelope to fuel and oil filters.
ENG(G)-13	Locate fuel filters to ensure no safety hazard will exist due to residual fuel during filter change.
ENG(G)-14	Access envelopes to fuel and oil filters should not be in close proximity to exhaust manifolds or cooling system return lines.
ENG(G)-15	Any single drive belt (excluding timing belts) should be capable of replacement within 30 minutes elapsed time
ENG(G)-16	Do not locate batteries in the engine compartment. In those instances where this is not possible: - The battery support structure should be of a material that is impervious to acid leakage or boil-over. - The battery support structure should serve as a scupper to collect and direct the acid out of the engine compartment.
ENG(G)-17	Install simple, lightweight shields over cooling system return lines to protect personnel from hose or line blowout during maintenance.
ENG(G)-18	Incorporate appropriate sensors to enhance the diagnostic and prognostic capabilities for the following: - Oil temperature - Oil pressure - Oil filter bypass - Oil cooler bypass valve position - Oil level - Oil return line particle count - Fuel filter bypass - Coolant pressure - Coolant level - Coolant temperature - Vibration pickups - Chip detector

List of Guidelines (Cont'd)

Guideline Numbers	Guideline
ENG(G)-19	Paint engine compartments gloss white to enhance light reflectivity and enhance fluid leak detection.
ENG(G)-20	Design all firewall fittings, connectors, and penetrations to be fully viewable and directly accessible to the maintainers.
ENG-01	All facets of engine design should take advantage of Electrostatic Engine Monitoring Systems (EEMS) and Inductive Debris Monitoring (IDM) toward achievement of on-condition maintenance and engine health monitoring.
ENG-02	Each different component of rotating machinery should contain different tracer elements to enhance EEMS and IDM isolation and tracking of wear.
ENG-03	Digital electronic controls, fully automatic digital electronic controls, and similar concepts should contain the highest degree of BIT and diagnostics commensurate with affordability, operation and maintenance, and life cycle costs as appropriate.
ENG-04	The engine and engine-mounted gear box should have individual oil supplies to ensure wear or failures in one will not contaminate or fail the other.
ENG-05	All engine-mounted air and fluid lines should be located next to the fan case, engine case, or full-length fan duct to ensure quick and simple replacement of accessories and components.
ENG-06	All other engine surfaces and engine-mounted accessory surfaces should be free of pockets, channels, and bathtubs that could trap and retain fluids.
ENG-07	Plumbing and wiring spanning two or more engine modules should contain in-line disconnects to enhance and simplify engine modularization.
ENG-08	Use V-band clamps to mount accessories to engine-mounted gear boxes.
ENG-09	On multi-engine air vehicles, the engines should be capable of being installed in any engine cavity without need for reconfiguration.
ENG-10	On multi-engine air vehicles, the airframe-to-engine interfaces should be in identical positions or orientations for each engine cavity.
ENG-11	Control-by-wire or control-by-light throttling concepts should take precedence over mechanical controls.
ENG-12	All engine-mounted accessories must be capable of being removed and installed through the available airframe access openings.
ENG-13	Engine oil systems should contain on-board spectrometric oil analysis devices located on the engine.
ENG-14	Coring of engine gear box cases and housings to provide for fuel heat sink routing should take precedence over dedicated fuel or oil heat exchangers.
ENG-15	Engine removal for aircraft intended to be operated off carriers should be accomplished within the shadow of the aircraft.
ENG-16	Aircraft jacking should not be required for engine removal.
ENG-17	Aft engine removal should be an acceptable alternative for USAF aircraft.
ENG-18	For either downward or aft engine removal, it should be possible to maintain control of the engine on all axis during the entire removal and installation process.
ENG-19	The minimum clearance between engine and airframe should be 1 inch, including removal and installation.
ENG-20	Do not locate equipment or components in the engine cavity except for those components associated with the engine or engine installation.

List of Guidelines (Cont'd)

Guideline Numbers	Guideline
ENG-21	Do not locate equipment or components in the engine bay cavity in a manner that would require removal or repositioning for engine removal.
ENG-22	The engine cavity structure should be capable of withstanding a 2000-degree Fahrenheit fire for 10 minutes without jeopardizing loss of the vehicle.
ENG-23	All engine borescope provisions should be accessible with the engine installed and hooked up.
ENG-24	Replacement of all ignitors should be possible with the engine installed.
ENG-25	All engine-to-airframe plumbing, wiring, and duct interfaces should be capable of being connected or disconnected by hand, should contain integral safety provisions, and should not require torquing.
ENG-26	Locate and position engine overheat and fire warning sensors so that damage cannot occur during engine maintenance or replacement.
ENG-27	No rigging or calibration should be required following engine replacement.
ENG-28	No engine operational start and checkout should be required following engine replacement.
ENG-29	No functional check flight should be required following engine change. On twin engine aircraft where both engines were changed simultaneously, a functional test flight is permissible.
ENG-30	It should not be necessary to close or reinstall engine access doors for engine ground operation up to and including military power.
ENG-31	No rigging or calibration should be required subsequent to replacement of any engine-mounted component.
ENG-32	Design the engine fuel controls and electronic controllers so that no manual fuel grade adjustments are required.
ENG-33	Engine access doors and panels and their integral support struts should be capable of withstanding 60 MPH winds in the opened position.
ENG-34	Identification plates on the engine and all engine-mounted components should be viewable with the engine installed and engine access doors opened.
ENG-35	No time-change components or scheduled actions should be planned solely to protect component integrity or reliability.
ENG-36	All borescope mechanisms should have positive integral locking features.
ENG-37	Gravity type servicing fittings, covers, and caps should have integral locking features, openable by hand, and contain a cable or chain to prevent loss or dropping.
ENG-38	The characteristics of engine-to-vehicle interfaces coupled with the capabilities of electronic engine controls, should negate the necessity for making any type of engine rigging including maximum power, idle, and idle cut-off.
ENG-39	Engine-to-vehicle plumbing quick disconnects should contain positive visual indication that the interface is fully seated and locked.
ENG-40	Design of electronic engine controls should be such that no single failure of a sub-component within can result in over speed, over temperature, stagnation, or shut-down.
ENG-41	Use captive fasteners containing self-locking features to attach the nose dome to the engine face. The fasteners should be fully viewable during engine face FOD inspections.

APPENDIX C

List of Guidelines (Cont'd)

Guideline Numbers	Guideline
ENG-42	Attach engine-to-inlet duct interface seals to the vehicle so they can be left in place during engine removal.
ENG-43	Design engine-to-inlet duct seal so the interface is automatic during engine installation without needing any form of alignment, adjustment, or mechanical attachment interface.
ENG-44	Select engine-to-inlet duct seal material to ensure seal life is sufficient for the life of the vehicle.
ENG-45	Provide remote servicing points accessible from the ground to service engine accessories mounted on top of the engine (e.g., oil tanks, gear boxes, generators, etc.) to eliminate climbing upon or atop the host vehicle.
ENG-46	Design the basic engine and engine-mounted accessory interface so that no fluid traps or bathtubs exist regardless of engine-mounted accessory location.
ENG-47	Design the engine, including all accessories, plumbing, wiring, ducts, and mechanisms, to meet the same environmental protection and compatibility requirements as the host vehicle.
ENG-48	Do not drain or dump residual fuel in the engine fuel control/manifold overboard. When it is not possible to follow this guideline, route the fuel to an engine-mounted collector tank capable of retaining fuel from two shutdowns.
ENG-49	Design engine fuel and oil filters with integral locking features so they can be installed and removed by hand, and require no torquing.
ENG-50	Design engine fuel and oil filter delta pressure indicators so they can be reset only from within the filter housing.
ENG-51	Provide engine fuel and oil filters with anti-surge protection to ensure false delta pressure indications do not occur.
ENG-52	Incorporate provisions to enable very slow rotation of the fan, compressor, and turbine during borescope inspections.
ENG-53	Design magnetic chip detectors to ensure that oil shut-off will occur as the detector is being removed for visual inspection.
ENG-54	Incorporate provisions for fuzz burn-off: in magnetic chip detectors.
ENV-01	Materials, treatments, coatings, finishes should be compatible with all anti-ice and de-ice fluids, chemical and biological decontamination fluids, washing and cleaning fluids, and all vehicle subsystem fluids.
ENV-02	There should be no top coat or treatment deterioration throughout the standard temperature and humidity spectrum.
ENV-03	For airborne vehicles, the finishes should be durable against rain, hail, and dynamic erosion throughout the flight envelope.
ENV-04	For airborne and ground vehicles, the finishes should be durable against sand erosion throughout all surface wind speeds experienced in arid or desert geographical locations.
ENV-05	For airborne vehicles, materials and all finishes with the engine inlet should be durable against hammer shock and compressor stalls.
ENV-06	For ground vehicles, the finishes should be compatible with and durable against all rain, hail, sleet, snow, and ice conditions experienced in all intended operational environments.
ENV-07	The finishes and surfaces should be capable of low velocity impact (LVI) of 10 foot-pounds with no visual or detectable damage with a design goal of 30 foot-pounds.
EXH-01	Treatments required for engine hot sections and exhaust areas should not require scheduled removals for the purposes of recoating.
EXH-02	High temperature exhaust patterns should flow away from or be directed away from treated surrounding structure, coatings, or finishes.
EXT-01	Locate Tanks, Pods, Containers, and Devices (TPCD's) so they do not block or restrict access to existing vehicle access areas or access approach envelopes.

List of Guidelines (Cont'd)

Guideline Numbers	Guideline
EXT-02	Design TPCD's for fuel containment to automatically interface to the host vehicle during installation or removal.
EXT-03	Design TPCD's to be fully compatible with the existing vehicle built-in hoisting provisions and locking devices.
EXT-04	Design TPCD's used for fuel containment so that post-installation operational tests or checks are not required.
EXT-05	Design access doors for cargo type TPCD's to be non-load carrying and with simple latches for all doors and panels.
EXT-06	Design cargo TPCD's to ensure all cargo and equipment can be downloaded and uploaded with the TPCD installed on the host vehicle.
EXTING-01	Use extinguishing concepts dedicated to each individual fire zone in preference to manifold systems operating from a central source.
EXTING-02	Design sealed extinguishing agent containers with an integral pressure/volume gage and a pressure-sensing transmitter for remote read-out.
EXTING-03	Keep each individual fire zone over-temperature/fire warning system separate from those in other fire zones.
EXTING-04	Design individual fire zone over-temperature/fire warning system to be fully BIT capable (the BIT concept should permit both initiated and periodic BIT).
EXTING-05	Route and locate all tube, wire, and plumbing interfaces in a manner that prevents induced damage during maintenance.
EXTING-06	Provide an alternate capability to activate the system remotely from the cockpit/crew station, or operator's position to satisfy emergency situations during vehicle maintenance.
EXTING-07	Analyze the vehicle operational environment and type of fire zones to determine if remote stop/shut-off of equipment is warranted.
EXTING-08	Analyze the vehicle operational environment and type of fire zones to determine if remote alarm and/or visual indication of a fire is warranted.
EXTING-09	Do not locate provisions for overboard venting or dumping of extinguishing agents in areas that could create hazards for personnel.
F-01	Use blind fasteners only where absolutely necessary or where considerable cost can be saved.
F-02	Mimimize access fasteners while making them quick release, easily removed and replaced, and captive.
F-03	Choose fasteners based on the requirement to operate by hand or with common hand tools rather than special tools.
F-04	Whenever possible, incorporate barrel type fasteners as opposed to hi-torque fasteners. Failure of Hi-torque fasteners due to stripping are common and a source of potential foreign object damage (FOD).
FI-01	Design each FI test to be independent of all other tests.
FI-02	Design FI initiation to be subordinate to the higher priority predecessor tests.
FI-03	Design each test so that it can be terminated prior to completion and then re-initiated at its start point.
FI-04	Design the unit tests so that they can accommodate the following subsystem response modes: <ul style="list-style-type: none"> - Incorrect response - No response - Inconsistent response - Unexpected condition
FI-05	Design all software so that it is structured by test priority. The test software should take advantage of both subroutine constructs for all message outputs and of failure dictionaries which identify the location of the most likely failed replaceable unit.

List of Guidelines (Cont'd)

Guideline Numbers	Guideline
FI-06	In an airborne avionics system, consider indicating mission critical faults on a pilots "head-up" display accompanied with an audible alarm, so that the pilot can easily check for critical system or mission threatening problems.
FI-07	Ensure that system user manuals include instructions for faults not covered by BIT such as, system will not power up or system is being used in an incorrect environment such as, at the wrong altitude, etc.
FI-08	Interlock the high power sections of systems and subsystems with visual/audible BIT to ensure safe system activation.
FI-09	Design BIT to first conduct self-test for circuitry integrity before conducting system test.
FI-10	Use clear text to report failures rather than alpha-numeric codes, lights, indicators, etc.
FI-11	Locate BIT circuitry on the same level of the subsystem under test to simplify test and repair when it is removed from the main system.
FUEL-01	Locate fuel vent and dump masts to ensure exiting fuel will be clear of servicing, loading, arming and safing areas for all types of ground and airborne vehicles.
FUEL-02	Manufacturing splices for major sub-assemblies should not intrude into or through integral fuel cells or tanks.
FUEL-03	Structural bolts, screws, and fasteners should not penetrate into integral fuel cells or tanks other than those used for access door attachment.
FUEL-04	Where the fuel wetted area inside a fuel cell or tank is void of blade, knife, and hat stiffeners for use as hardpoint attachment, standoffs bonded to the cell surface should be used as attachments for clamps, and brackets to eliminate fastener penetration of the fuel cavity.
FUEL-05	Intersecting of two or more surfaces in a fuel wetted area of less than 90 degrees should be avoided to simplify manufacture and repair.
FUEL-06	Where maintaining a minimum angle of 90 degrees is not possible, sufficient depth, width, and height should be maintained to provide tool clearances for all tools used in the manufacturing processes and in the operational field repair environment.
FUEL-07	When feed tanks are designed such that the lower portion of the tank serves as a surge chamber, the top closure deck of the surge chamber should provide the strength to support the weight of a 95 percentile male.
FUEL-08	The size and number of fuel cell and tank access doors should be sufficient to ensure no wetted area of the cell or tank is beyond a maximum 18" distance from the edge of the access opening. This guideline applies to only non-man rated cells.
FUEL-09	All fuel cell or tank access doors not mounted on the exterior surface should contain sealing provisions other than the channel type.
FUEL-10	Provide access from the wing closure ribs in lieu of the moldline when access is required in close proximity to the wing fold area.
FUEL-11	Through-the-tank fasteners should not be used for fuel cells or tanks in areas where a leak path could be established into an inaccessible portion of the vehicle.
GBD-01	Guidelines for transmissions, clutches, and rotors apply.
GBD-02	Use the host gear box lubricating system to provide lubrication of the drive shaft spline.
GBD-03	Design drive shafts using the "blind spline" concept to ensure correct mating of the shaft to the gear box.
GBD-04	Design drive shafts with a simple, light-weight cover to protect personnel.
GBD-05	Design drive shaft covers with a hole or slot type opening to prevent the masking of leakage or damage.
HF-01	Steps and handholds for all ground vehicles should be parasitic to the surface and capable of safely supporting a 95 percentile male wearing arctic boots.

List of Guidelines (Cont'd)

Guideline Numbers	Guideline
HF-02	Locate identification and modification plates for all major structural assemblies and subassemblies so as to be fully visible and legible when viewed through normal access provisions. Avoid the need to remove equipment or components to view the plates.
HF-03	Provide hoist fittings or hardpoints for hoist fitting attachments that are readily accessible.
HF-04	Size structural openings into man-rated fuel cells to enable entry by a 75 percentile male.
HF-05	In designing the vehicle, system, subsystem, and equipment, attempt to satisfy the personnel spectrum from the 5th percentile female to the 95th percentile male.
HF-06	Recognize that design ingenuity cannot overcome the fact that certain tasks may be outside of the capabilities of females in the lower percentile ranges. Many of these tasks may also be outside the capability of a large portion of the male lower percentile ranges. In designing, proactively recognize these inabilities so the necessary scope and depth of good design tradeoffs can be identified or expanded. The tasks include: <ul style="list-style-type: none"> - Manually loading many types of weapons. - Pushing an engine/transport trailer combination. - Handling various large actuators, motors, or generators. - Removing, installing, and handling many built-up wheel and tire assemblies. - Lifting a large percentage of avionics. - Reaching all areas of windshield/canopy surfaces for cleaning. - Moving major support equipment. - Handling tie-down chains. - Pulling or removing pinched chocks. - Lifting tool boxes. - Aiding in pilot rescue. - Safely moving about in high over-the-deck or ground surface winds. - Riding brakes or taxiing aircraft. - Lifting and connecting refueling hoses. - Changing or repairing tank treads. - Handling small ammunition containers. - Achieving high torque values.
HF-07	Recognize that design ingenuity cannot overcome certain tasks that are not within the capability of the 95 percentile male. In designing, proactively recognize these inabilities so the necessary scope and depth of good design tradeoffs can be identified or expanded. The tasks include: <ul style="list-style-type: none"> - Pulling circuit breakers with a gloved hand. - Achieving good working access inside of many equipment bays and compartments. - Working under air vehicles with lower shears less than 32 inches above the static ground line. - Connecting and disconnecting electrical connectors that are generally considered to be sufficiently spaced. - Recovering a dropped tool from many different bays and compartments. - Preparing many different types of vehicles for operation while wearing arctic clothing or chemical/biological protective gear.

List of Guidelines (Cont'd)

Guideline Numbers	Guideline
HF-08	Avoid solely relying on decals, placards, or instruction media to simplify or negate redesign. In rare instances such use of decals, etc. may lead to significant payoffs, the decision should be supported by complete analysis and supporting rationale.
HF-09	Develop decals, placards and instruction media around an 8th grade reading level and a 10th grade level of comprehension.
HOOK-01	Locate, orient, and mechanize Nose Gear Tow/Nose Gear Holdback (NGT/NGH) mechanisms so they do not interfere with the hookup and attachment of standard towbars.
HOOK-02	Design NGT/NGH mechanisms with integral provisions to visually indicate correct hookup/attachment. The indication must be visible during all day and night carrier operations.
HOOK-03	NGT/NGH mechanisms should not require scheduled visual or NDI type inspections.
HOOK-04	Design tail hook points to be interchangeable and easily replaceable.
HOOK-05	Design tail hook points so they can not be incorrectly installed.
HOOK-06	Avoid the need to remove the tail hook to facilitate engine access or removal.
HOOK-07	Incorporate remote means to read the tail hook dampener pressure charge to enhance carrier suitability.
HYD-01	For military combat vehicles having two or more hydraulic power systems, provide a minimum 30-inch spacing between ground power and servicing interfaces to ensure: <ul style="list-style-type: none"> - Design flexibility in locating and arranging equipment in high-density vehicles such as fighters and helicopters, - Work area separation to enable concurrent service/maintenance on systems, - Systems vulnerability enhancement, - Reduction in turn-around elapsed time due to concurrent servicing capability.
HYD-02	Use identical components, such as pumps, reservoirs, and accumulators, in each individual power subsystem. In instances where this is not fully possible, perform and document trade studies or appropriate analysis to provide justification and supporting rationale.
HYD-03	Use identical types of fluid in all hydraulic subsystems. Brakes may be the exception only if the system is totally separated from the independent of other hydraulic systems.
HYD-04	For vehicles containing two or more systems with different fluids, use different service fittings and different ground power interfaces for each fluid type.
HYD-05	Design protective caps or covers over service fittings with steel cable lanyards to prevent loss and migration in the vehicle.
HYD-06	Mount hydraulic pumps to the gear box flange with v-band clamps containing a torq-set or equivalent fastener.
HYD-07	Modularize electric-driven hydraulic pumps to enable replacement of the drive motor without interruption of the fluid lines.
HYD-08	Design hydraulic pumps and motors with tracer elements to detect wear through on-board spectrometric oil analysis devices.
HYD-09	Provide hydraulic devices used in critical applications with integral 5 micron filtering.
HYD-10	Design the fluid storage system so it can be serviced in one-quart increments to eliminate the effects of handling and storing partially-filled cans.
HYD-11	Design flexible hose with molded-in color bands to clearly indicate when the maximum wear/abrasion has been reached.

List of Guidelines (Cont'd)

Guideline Numbers	Guideline
IN(V)-01	Design inlet door actuators and door actuation mechanisms so they not protrude into the air inlet flow field to eliminate FOD potential.
IN(V)-02	Do not use loose structural fasteners in the access area to inlet door actuators and mechanisms. Where this guideline cannot be followed, design the actuator door to be accessible only when the inlet doors are fully closed.
IN(V)-03	For engine inlet bellmouth fairings, use methods of retention other than fasteners. Latches may be considered as an acceptable alternative only if latch-to-panel retention is from the inner mold line.
IN(V)-04	Design inlet doors and inlet bellmouth fairings to be fully interchangeable to eliminate the need to cut, file, or trim at the engine face.
IN(V)-05	Locate the inlet duct edge a minimum of 60 inches from the cockpit or crew station to eliminate restricting engine operation to canopy-closed conditions.
IN(V)-06	Use captive fasteners on all access doors forward of the inlet to significantly reduce engine FOD potential.
IN(V)-07	Ensure that no ground safety pins or streamers are used forward of the inlet or within a 3-foot radius aft of the inlet.
IN(V)-08	Incorporate an inlet closure door sealing concept that prevents entry of fluid, dust, or sand across the entire airborne and ground environment spectrum.
IN-01	Low Observable (LO) engine face frames should be within 10 inches of the first stage fan or compressor blades.
IN-02	Openings throughout the engine face frame should be sufficient to perform a 100% FOD inspection of the engine face.
IN-03	Openings throughout the engine face frame should be sufficient to permit minor blending or repair of FOD without removing the engine.
IN-04	For frames not integral with the engine, frame removal should be achievable from the engine cavity.
IN-05	Both integral and remote engine front frames should be interchangeable.
IN-06	Front frame anti-ice and de-ice provisions should give preference to engine hot bleed air.
LG-01	Bearings, excluding wheel bearings, should not require lubrication during the expected life of the air vehicle airframe.
LG-02	Hardpoints for attachment of landing gear trunnions should be capable of carrying all induced gear loads for the life of the airframe.
LG-03	Hardpoints for attachment for landing gear trunnions should not be machined as an integral part of the airframe structure when normal design sink rates over 25 feet per second are required.
LG-04	Do not use Beryllium and Beryllium base alloys in any location subject to wear or corrosive atmospheres or in installations where machining may be required.
LG-05	All bolts or similar threaded means used as adjustable stops should be positively retained in the adjusted reference without reliance on jam nuts, cotter pins, or safety wire.
LG-06	Design struts, attachments, and interfaces so they do not depend on scheduled visual inspections, non-destructive inspection (NDI), or non-destructive test (NDT) to ensure the reliability or integrity of the system in the operational environment.
LG-07	No portion of the landing gear struts, drag braces, or interfaces should contain pockets or bathtubs that can trap or hold moisture. In rare instances where this is not possible, holes should be drilled as appropriate to prevent moisture/liquid accumulation.

List of Guidelines (Cont'd)

Guideline Numbers	Guideline
LG-08	Brackets, levers, links, rods, et al mounted on the struts should either be symmetrical to tolerate reverse installation or should be impossible to reverse.
LG-09	Use coiled tubing in lieu of flex lines or hoses for hydraulic line routing from the airframe to the strut.
LG-10	All wiring or coax mounted to a strut should have appropriate interface connectors to simplify strut removal and installation.
LG-11	All microswitches, proximity switches, lights, sensors, etc. mounted to a strut should have individual interface connectors. Wiring pigtails requiring in-line splices should be avoided.
LG-12	All struts should contain a spare strut lower seal stowed in the strut collar to avoid removing the lower strut for leak repair.
LG-13	No special tools or equipment should be required to maintain/service struts in normal day-to-day operational environments.
LG-14	All interfaces from the airframe to the struts should be visible and accessible, and not require removal of airframe structure for access.
LG-15	No portion of the landing gear closure door(s) should be attached to the strut. In rare instances where this may not be possible, that attached portion should not require alignment or rigging.
LG-16	No portion of the landing gear rigging process should require support equipment type templates, gauges, or tools. Indexes, reference points, etc., should be an integral part of the landing gear/airframe design.
LG-17	Hydraulic, pneumatic, or electrical actuators associated with landing gear systems should not require adjustment or rigging once installed in the air vehicle. Spare units should be rigged at the time of manufacture or overhaul.
LG-18	Landing gear ground safety down locks should be an integral part of the overall design. Use or reliance on loose pins (support equipment) should be avoided.
LG-19	When deemed necessary for the respective design, pilots, flight crews, or operators should have an indication of the downlock status in the cockpit or crew station to avoid the necessity of a flight abort.
LG-20	Special locks and pins used solely for landing gear ground maintenance safety should be used only in those cases substantiated by cost effectiveness analysis.
LG-21	Proximity type switches used in landing gear design should meet a minimum of 200 volt-amperes to eliminate Electromagnetic Interference (EMI) or Radiation Hazard (RADHAD) problems. Wiring associated with the landing gear design should meet the same requirements.
LG-23	Design strut fittings for servicing nitrogen or hydraulic fluid to be easily accessible and adjacent to the appropriate strut pressure gage.
LG-24	Design struts so they can be serviced with clean, dry air in lieu of nitrogen during deployments without affecting the overall reliability.
LG-25	Mechanical shrink struts, when used, should not permit gear to jam in wheel well if failure of shrink mechanism occurs.
LG-26	Gravitational emergency extension of landing gear should be given preference over all other concepts.
LG-27	Downlocks should be over-center mechanical type and should not depend on hydraulic pressure to maintain the lock.
LG-28	Landing gear control handle should have only "up" or "down" detents with no neutral or intermediate positions.
LG-29	Basic gear design combined with manufacturing tolerances should ensure that no uplock or downlock rigging is required.

List of Guidelines (Cont'd)

Guideline Numbers	Guideline
LG-30	Do not use landing gear wells to locate any type of auxiliary air inlet.
LG-31	Landing gear doors designed to close after gear is extended should be capable of being manually opened on the ground without reliance on electrical or hydraulic power.
LG-32	Design of landing gear doors normally closed after gear extension should ensure failure modes will not enable uncommanded opening on the ground.
LG-33	Design of landing gear doors normally left open after gear extension should ensure no failure mode will enable closing on the ground.
LG-34	Avoid sharp edges and corners on landing gear doors or fairings.
LG-35	Avoid the use of landing gear doors to mount or house antennas, arrays, or air data sensors.
LG-36	Location of integral wheel jack points on a strut should provide a minimum 6-1/2 inch clearance for positioning the jack with tire ruptured and wheel ground 2 inches off ground.
LG-37	Integral hardpoints to jack the entire vehicle should ensure that identical jacks can be used at all jack points.
LG-38	All landing gear doors should be interchangeable.
LG-39	Gear-mounted tie-down or chain-down fittings should be interchangeable and easily replaceable.
LG-40	Nose gear design and selection of nose gear seals should ensure strut will gradually compress while aircraft is being fueled. Sticking struts followed by sudden compressing is highly hazardous to personnel and equipment.
LG-41	No more than 1 jack should be required to change any singular wheel/tire assembly.
LG-42	Landing gear struts should contain built-in, dial type pressure gages.
LG-43	Incorporate low pressure warning sensors in nose landing gear whenever under-servicing of the gear could result in failure to rotate aircraft during takeoff. This feature will eliminate many aborted take-offs, many of which result in blown tires or aircraft leaving the runway.
LG-44	Landing gear door mechanisms and interfaces should ensure that multiple cycles or occasional exceedence of maximum gear-down speed do not result in loss of doors
LO-01	Use LO compatible gap fillers for manufactured gaps in lieu of tape and butter (surface coating compound).
LO-02	Avoid scheduled forced inspections or replacement of materials, coatings, or finishes solely to protect either the reliability or the signature.
LO-03	Equipment and support structure requiring shrouds to reduce radar returns should not cause increases in equipment service/repair time.
LO-04	Infrequently-accessed structural doors and panels incorporating special coatings or conductive paints should contain provisions for prying the door or panel clear of moldline with standard screwdriver without damage.
LO-05	Do not locate flush mounted LO screens for auxiliary air inlets and exits in walkway areas unless durability has been proven.
LO-06	Size flush mounted LO screens for auxiliary air inlets and exits to ensure functionality with up to 25 percent of the openings plugged.
LO-07	Flush and non-flush LO screens should be interchangeable.
MATL-01	A high degree of durability should be maintained for a minimum distance of 36 inches forward of the inflight refueling receptacle.

List of Guidelines (Cont'd)

Guideline Numbers	Guideline
MATL-02	Cosmetic type repairs should not exceed 1 hour including cure or drying times.
MATL-03	Cosmetic and vehicle repair material shelf life should not be less than 24 months.
MATL-04	Cosmetic and vehicle repair materials should be non-proprietary and non-single source.
MATL-05	Cosmetic and vehicle repair materials should not require refrigeration or special facilities or atmospheres for storage.
MATL-06	Repair criteria, repairs, and instructions should not be classified.
MATL-07	All cosmetic touch-up and repair materials should be environmentally safe.
MATL-08	Repairs (other than major depot repair) should not require autoclave type facilities.
MATL-09	A high degree of durability should be achieved across all walkway areas on the top surfaces of all vehicles up to and including 95 percentile personnel.
MATL-10	Coatings and finishes should be durable against the effects of missile gases, velocities, and particles emanating from the missile motor.
MATL-11	Coatings and finishes should be durable against the effects of gun gases, projectile shock waves, and brass particles emanating from the projectile seal rings.
MATL-12	Leading edge materials and coatings should be durable against fragments from frangible gun port plugs.
MATL-13	Special handling or shipping requirements of repair materials should be avoided.
MATL-14	Leading edges, including chimes, containing or constructed of radar absorbing materials, should be interchangeable to reduce vehicle downtime and simplify repairs.
MATL-15	Doors and panels containing blade seals used for signature reduction should be interchangeable or contain interchangeable blade seals. Deviation is acceptable where repairs can be accomplished on the vehicle in a time equal to or less than door or seal remove and replace time.
MC-01	All clamps should contain torque-set or torque-limiting connections to prevent clamp or component failure due to over-torque. Clamp installation call outs should not depend on special tools to establish the required torque values.
MC-02	Avoid the use of cotter pins, safety wire, safety clips, and similar devices to prevent maintenance-induced events leading to ground vehicle accidents or loss of air vehicles.
MC-03	All tubing connections and interfaces should use rosan/dynatube (or equivalent) to (1) enable connect or disconnect with one hand, one tool, (2) eliminate the need to safety the connection, (3) provide a superior seal, and (4) negate need to reposition line(s) during component replacement.
MC-04	No trombone type, flared tube type, or piloted line type interfaces should be used to avoid the need for removal or repositioning during equipment removal.
MC-05	Avoid potential foreign object traps during manufacturing or operational maintenance by eliminating vertical penetrations of plumbing/fittings into tanks, compartments, or cells
MC-06	Locate, position, orient all plumbing and duct electrical connectors to prevent the need for sequential installation or removal.

List of Guidelines (Cont'd)

Guideline Numbers	Guideline
MC-07	Maximize areas of constant web thickness in firewalls, carry-through bulkheads, major frames, structural ribs, spars, webs, keels, and close-outs to provide flexibility in locating penetration fittings. Stepped chem milling, stepped machining, stepped composite layup concepts all tend to result in minimal available surface area for penetrations.
MC-08	All in-line plumbing connections within a fuel tank or cell should be capable of making/breaking the interface by hand, require no torque, contain integral safety locking mechanisms, and should be void of any requirement for safety wire.
MC-09	All plumbing connections and fittings used for fuel systems should contain integral bonding features to eliminate the need for bonding clamps or jumper cables.
MC-10	In rare instances where a plumbing run contains complex form or geometry that would require removal of other plumbing or equipment for access, in-line connectors should be incorporated to maintain the integrity of other plumbing or equipment.
MC-11	No subsystem plumbing, equipment, or wiring should use a tank, cell, or compartment containing liquids as a means for routing or penetration simplicity during manufacture.
MC-12	All plumbing and connectors containing liquids should be meniscus-free.
MC-13	In instances where plumbing or connector interfaces cannot or are not keyed for a specific orientation, all identification, markings, cautions, and directions should be placed 360 degrees around the tube or duct.
MC-14	Where multiple connectors are located in close proximity, ensure (1) a minimum hand tool arc of 120 degrees can be maintained, and (2) stagger fittings to ensure firm coupling interface/hand tool interface can be accomplished without inducing damage to adjacent lines.
MC-15	Route, orient, and position plumbing, wiring, ducts, and connectors sufficiently away from the outer surface of the vehicle to preclude induced damage due to minor dents, drill bits during repair, etc. Minimum rule of thumb is 1" away from the inner surface and 1" below a plate nut channel.
MG-01	Mount LRUs/sub-systems on drawer slides or extender racks to provide easier accessibility during integration, testing, debug, and repair of Units Under Test (UUTs).
MG-02	Use a modular system design so that each subassembly is designed as a functionally complete entity. Then when a subassembly was removed for testing, ATE will not need custom circuitry to simulate missing functions.
MG-03	Clearly mark all subsystems/LRUs to make system integration, test, debug, and repair easier.
MP-01	Avoid the use of epoxies to mount parts on repairable modules because they make repair extremely difficult.
MP-02	Use a unique identification (ID) resistor incorporated in each system module to verify that the proper module is mounted on ATE.
MP-03	Design modules so that lengthy warm-up times, special coding and air purity levels, and similar constraints are not necessary.
NDI-01	Avoid reliance of extensive interpretation by NDI equipment operators to detect structural flaws.
NDI-02	Do not use non-destructive inspection technologies to maintain or protect the reliability of an item.
NDI-03	Derive NDI/NDT requirements from the Failure Mode Effects and Criticality Analysis (FMECA) and the associated Reliability Centered Maintenance (RCM) analysis and documentation.

List of Guidelines (Cont'd)

Guideline Numbers	Guideline
NDI-04	Evaluate selective application of appropriate NDI/NDT technologies against high-time units, items, and vehicles with the intent of: <ul style="list-style-type: none"> - Finding the optimum time intervals, - Preventing the across-the-board application of NDI/NDT, - Increasing the time intervals between inspections, and - Eliminating the requirement.
NDI-05	Include the effect and impact of NDI/NDT applications as a major element in developing operations and support cost (O&S) analysis to include: <ul style="list-style-type: none"> - Cost of Equipment - Cost of Facilities - Cost of PMEL - Cost of training/retraining - Cost of personnel - Impact on deployment - Impact on sea/air/land lift
OXY-01	System should contain automatic BIT for warning indicators to eliminate dedicated test switches and/or test requirements.
OXY-02	Provide sensors to denote occurrence of On-Board Oxygen Generating Systems (OBOGS) bleed air over temperature.
OXY-03	Provide condition sensors for oxygen concentrators to eliminate periodic and/or forced replacement.
OXY-04	OBOGS should be given preference over liquid oxygen systems.
OXY-05	Locate liquid oxygen (LOX) containers in a sealed, dedicated compartment to eliminate need for frequent visual inspections.
OXY-06	Liquid oxygen container design and integration should contain appropriate sensors to detect and monitor air filter brazement.
OXY-07	Locate liquid oxygen containers to ensure simultaneous replacement with other turnaround activities.
OXY-08	LOX containers should contain rear mounted, automatic interfaces.
OXY-09	Special or common hand tools should not be required to remove or replace LOX containers.
OXY-10	Effective leak detection sensors should be integral to the system.
OXY-11	System operational and service condition status should be capable of being downlinked to centralized maintenance facilities.
OXY-12	LOX compartments should be sealed from adjacent compartments and should contain dedicated overboard drains.
P-01	Access door and panel fastener types for airborne vehicles should meet the following criteria: <ul style="list-style-type: none"> - use latches for a frequency of access of 0 to 40 flight hours - use High Strength Quick Release fasteners for a frequency of access of 40-400 flight hours - use structural screws for a frequency of access of 400 flight hours or more

APPENDIX C

List of Guidelines (Cont'd)

Guideline Numbers	Guideline
P-02	Access door and panel fastener types for surface vehicles should meet the following criteria: - use a spring loaded or latch fastener for an opening frequency of daily - use a one quarter turn fastener (or equivalent) for a opening frequency of weekly - use screws or bolts for all other cases
P-03	All doors and panels subject to environmental elements should contain form-in-place seals (or equivalent) attached to the door structure, not substructure, to prevent damage during maintenance.
P-04	Door and panel seals should be compatible with all types of on-board servicing fluids, de-ice and anti-ice fluids, and all fluids used for chemical, biological, and nuclear decontamination.
P-05	Piano type hinges should not be used on doors or panels because they are subject to wear, corrosion, and sand and fluid entry.
P-06	Access door and panel devices used to support door in opened position should meet the following criteria: - for airborne vehicles, design for 60 knot gust loads (or equivalent jet blast loads) - for ground vehicles, design for 50 mph gust loads
P-07	Hinged access doors and panels capable of remaining in the opened position should not have sharp edges or corners.
P-08	Removable access door and panel fasteners should be of identical grip length and diameter.
P-09	Acceptable door and panel hold-open devices include over-center sheet metal spring, over-center spring link, spring cartridge, support strut, and pinned goose neck hinge.
P-10	Access doors and panels requiring non-captive fasteners should not be located forward of air inlet ducts or high-energy rotating components (e.g., prop fans, engine cooling fans, etc.).
P-11	Access doors and panels should be interchangeable as justified by operation and support costs or life cycle costs.
PERS-01	Group man-machine interfaces manifold-style to enable connect/disconnect in a single action.
PERS-02	Include an integral, highly visible indicator in a man-machine interface connector to denote connector is seated and locked.
PERS-03	Design interface connectors so that a distinct action is required by an individual to effect a disconnect. (Excludes airframe-to-ejection seat personnel interfaces.)
PERS-04	Interfaces should contain an emergency release mechanism that can be activated by rescue personnel with a 95 percentile gloved hand.
PERS-05	Design emergency interface release mechanisms to be clearly visible under all types of lighting situations.
PERS-06	Storage bins, compartments, sacks, or bags should be available within the vehicle to store/protect all personal equipment required to conduct operations.
PERS-07	All flight and ground vehicles should contain one cubic foot minimum storage compartment(s) for various loose and sundry personal items (for each individual).
PERS-08	Design stowage and mounting provisions for portable air or oxygen containers to withstand 40G crash or impact loads.
PERS-09	Design portable emergency locator beacons, radio receiver/transmitters, global positioning systems, and similar battery operated devices with integral provisions for determining battery health or status and remaining battery life.

List of Guidelines (Cont'd)

Guideline Numbers	Guideline
PYRO-03	Provide the pilot or the weapon officer, crew, or gunner with the capability to electrically arm/safe each respective weapon from the cockpit, crew station, or operator station as appropriate.
PYRO-01	Provide the "safe/arm" status to the pilot, crew, or gunner in the cockpit, crew station, or operator station as appropriate.
PYRO-02	Provide the "safe/arm" status as an external cue discernible from a distance of 10-20 feet.
PYRO-06	"Safe/arm" mechanism design should be free from FOD potential.
PYRO-07	Manual "safe/arm" mechanisms should be well-clear of inlet ducts, propellers, rotors, and similar rotating components.
PYRO-08	Manual "safe/arm" mechanisms should be well-clear of engine exhausts, fuel/toxic vents, fluid drains, control surface deflection envelopes, and rescue path envelopes.
PYRO-09	Provide positive, Murphy-proof locking detents for both the "safe" and "arm" positions of mechanical mechanisms.
PYRO-10	Provide a numerical maintenance code on maintenance panels or maintenance recorder/memory systems to denote the "safe/arm" status for each weapon or store.
PYRO-11	Design electrical/electronic "safe/arm" systems to eliminate the need for mechanical type system interrupt devices.
PYRO-12	Design of weapons, flare/chaff packages, and airborne pyrotechnic containers should follow the "wooden round" design concept to eliminate scheduled tests, checks, and inspections throughout its intended life cycle.
PYRO-13	Container design for shipping, handling, and storing weapons, flares, chaff, and similar devices should not require special atmospheres.
PYRO-14	Design weapon drop and fire/release circuits with frequency-coded firing systems or similar concepts to ensure stray energy tests and checks will not be required and that stray energy will not impose a safety hazard or problem.
PYRO-15	Pylon-to-weapon and pylon-to-air vehicle electrical interfaces should contain built-in test/fault location capabilities.
PYRO-16	Do not use cartridge actuated devices (CADs) for store or weapon ejection or for pylon jettison due to inherent ground safety hazards, stray energy hazards, and scheduled cleaning requirements.
PYRO-17	In rare instances where use of CADs may be required, a positive indication to denote "cartridge installed" should be provided.
PYRO-18	Mechanical "safe/arm" mechanism design should enable activation by a 95 percentile male wearing arctic mittens.
PYRO-19	Locate built-in grounding receptacles clear of weapon approach and loading envelopes.
PYRO-20	Weapon bay doors, when opened, should not block or restrict access to other servicing points.
PYRO-21	Weapon bays should contain internal lighting controlled by a separate switch that is only functional when doors are open
PYRO-22	A "rounds remaining" status should be available at the gun loading interface, maintenance panel, or cockpit/crew station/operator station.
PYRO-23	Crew size for full ammo load should not exceed two persons.
PYRO-24	Ammo loader interface should not be less than 30" nor more than 50" above the ground to ensure loading can be accomplished by a wide range of percentiles wearing chemical or biological protective gear.
PYRO-25	Gun loading and servicing should be possible concurrently with all other weapon loading and servicing activities to minimize the elapsed downtime.

List of Guidelines (Cont'd)

Guideline Numbers	Guideline
PYRO-26	Do not locate ammunition loader interfaces close to inlets, exhausts, fuel dumps and drains, antennas, sensors, lights, or hazardous protrusions.
PYRO-27	Incorporate integral hoisting provisions at each weapon/store station to enable direct lift from the container or carrier to the attachment hardpoints.
PYRO-28	Automatic locking of the retention hooks should be accomplished for each respective weapon and store.
PYRO-29	Provide quick mechanical over-travel (no power) for weapon bay doors to maximize the weapon/store loading envelope.
PYRO-30	Ensure weapon bay door arc (both normal and over-travel) does not block or intrude into adjacent service points or envelopes.
PYRO-31	Ensure weapon bay door open positions do not intrude into any other door opening envelope.
PYRO-32	Provide sufficient longitudinal clearance between weapon bays to enable simultaneous loading of two bays.
PYRO-33	Provide sufficient lateral clearance between weapon bays to enable simultaneous loading of two bays.
PYRO-34	Weapon bay door seals should be bonded or attached to door structure to minimize induced seal damage during weapon or store loading.
PYRO-35	Suspension system should permit any single weapon or store to be loaded by a two man crew.
PYRO-36	Suspension system design and spacing should enable any combination of eight weapons to be loaded by two two-man crews within the refueling time of the vehicle (excludes nuclear weapons).
PYRO-37	Internal weapon suspension arrangements should preclude sequential weapon loading.
PYRO-38	Any single pylon or built-up pylon/weapon package should have the capability for rapid reconfiguration.
PYRO-39	Weapon bay ejectors and launchers should have the capability for total interchangeability and reconfigurability.
PYRO-40	All weapon and store loading functions should be within the percentile range of 5% female to 95% male standing at ground level.
PYRO-41	Weapon or store handling and transportation equipment should be compatible with rough terrain and capable of 25 mph towing speeds minimum.
PYRO-42	In weapons carriage design and integration, avoid dependence of on-board high pressure nitrogen.
PYRO-43	Launcher or ejector design/interface should not require a dual function of carrying airframe structural loads.
PYRO-44	Launcher and ejector design should incorporate automatic sway bracing.
PYRO-45	Missile ejectors should be provided with repeatable missile motor fire wires to simplify loading and reduce elapsed time.
PYRO-46	Design pylons, launchers, and ejector racks so that weapon loading, servicing, and reconfigurations can be accomplished using standard hand tools.
PYRO-47	Installation design of ejectors, launchers, racks, and associated hardware interfaces should avoid reliance on torque wrenches.
R-01	Large radomes wherein the combination of the diameter and length exceeds 60" should be top-hinged. Hinge should be load-carrying to reduce radome retention fastener count.
R-02	Radome and radar array support structure design and material selection should eliminate the need for LO type fillers or shrouds.

List of Guidelines (Cont'd)

Guideline Numbers	Guideline
SABCH-01	Do not locate auxiliary air inlets, sensors, access doors, or drains in boundary bleed areas.
SABCH-02	All flush type structural screws should have identical head drives for the entire vehicle.
SABCH-03	All non-flush type structural screws should have identical head drive recesses for the entire vehicle.
SABCH-04	Special high strength bolts, such as twelve-point heads, should be fully justified from standpoint of the cost of ownership and effectiveness.
SABCH-05	Structural design should avoid the reliance on blind fasteners unless fully supported by cost, weight, schedule, and effectiveness analysis.
SABCH-06	Structural design should avoid the potential of dissimilar material or fastener corrosion.
SABCH-07	No structural fasteners should be used that require special tools for installation.
SABCH-08	Taper pins should be threaded and retained with self-locking hardware.
SABCH-09	Pins and collars (lockbolts) should only be used in applications which do not normally require removal.
SABCH-10	Do not use lockbolts in composites.
SABCH-11	In rare instances where the use of dissimilar material in immediate contact cannot be avoided, they should be sufficiently insulated to endure for the life of the vehicle.
SABCH-12	Avoid tapping threads into structural members. Use of heli-coil type or similar insert concepts is permissible.
SABCH-13	No structural design concept should rely on frequent scheduled inspections to monitor or otherwise ensure structural integrity.
SABCH-14	No structural fastener intended to carry shear or tension loads should be smaller than 1/4" diameter (.25").
SABCH-15	Give preference to butt type splices over lap type splices in the design of manufacturing splices.
SABCH-16	Wing-to-fuselage attachment should give preference to tension ties over shear ties to improve overall volumetric efficiency.
SABCH-17	Hardpoints for securing tie down chains, cables, and devices during transport should not require reaching under or crawling under the vehicle.
SABCH-18	Rings, posts, and clevis devices used for attaching tie downs should not require opening of doors or panels for access.
SABCH-19	Avoid tie down concepts requiring attaching hardpoints as a prerequisite.
SABCH-20	Location of hardpoints used for tie down attachment should: <ul style="list-style-type: none"> - Remain outside of door and panel opening envelopes. - Be clear of exhaust pipes, ducts, manifolds, and mufflers. - Be clear of overboard fluid drains and vents.
SABCH-21	Tire pressure reduction should not be required prior to tie down solely to increase the tire footprint
SAFE-01	Drag chute installation designs not containing electrical safing should contain remote safe/arm provisions reachable from ground level by 5 percentile females. Remove location should be clear of engine exhaust areas and flight control deflection envelopes.
SAFE-02	Emergency ingress actuation provisions into cockpits, crew stations, passenger compartments, and operator stations should be accessible from the ground by 5 percentile females.

APPENDIX C

List of Guidelines (Cont'd)

Guideline Numbers	Guideline
SAFE-03	Stored energy devices (e.g., accumulators, nitrogen bottles, gas generators, etc.), that could cause injury, harm, or damage if inadvertently actuated, should contain integral safing provisions.
SAFE-04	Electrical and optical safe/arm system design should eliminate the need for mechanical type system interrupt devices.
SAFE-05	Crash locator beacon door opening/ejection mechanisms should contain integral electrical safe/arm features.
SAFE-06	Wing fold locking mechanisms should provide a moldline indication that locks are in place. Loose or separate safety devices that must be installed manually should be avoided.
SAFE-07	Landing and alighting gear design should ensure downlocks are integral to the mechanisms and provide a clear indication of position status. This guideline also applies to tail hooks.
SAFE-08	A single lever safety should, when positioned, safe the entire escape/ejection system. Use of the single lever to "arm" should require two hands.
SAFE-09	Safing the canopy jettison system should be accomplished through the same lever device used to safe the ejection seat.
SAFE-10	The single lever safing concept should apply to day-to-day flight operations. Individual or multiple safety pins for pyrotechnic devices should only be required during escape system maintenance.
SAFE-11	All individual safety pins used for ground maintenance should be clearly visible and coupled together to ensure no single pin will be overlooked during arming.
SAFE-12	Internal weapon bay doors should contain integral safety locking features for use during maintenance and weapon loading and downloading.
SAFE-13	It should not be possible to unsafe a weapon bay door integral lock when a door closed signal is present.
SE-01	Wheel chocks for all types of ground and airborne vehicles should contain the following features: <ul style="list-style-type: none"> - Be nestable for low volume during storage or transport - Be manufactured from corrosion-resistant materials - Be releasable from tire pinch - Be highly visible for day and night operations - Be impervious to all types of fluids used to service or maintain the vehicles - Be of light weight
SE-02	Wheel chocks for airborne vehicles should also contain the following features: <ul style="list-style-type: none"> - Contain provisions for securing to ramp or flight decks - Contain provisions to secure chocks at wheels - Releasable/removable from outside of hot brake envelope - Contain provisions to enable chock to be used as a tire blowout device - Contain provisions to prevent skidding on snow or ice

List of Guidelines (Cont'd)

Guideline Numbers	Guideline
SE-03	Wheel chock design guideline discussion. Wheel chocks have historically contributed to numerous accidents and incidents across the entire design spectrum, yet have received the least design attention of any ground handling/support equipment. Directly and indirectly, poorly designed chocks have: <ul style="list-style-type: none"> - Resulted in numerous "jumping the chocks" incidents due to improper use or positioning, and improper chock sizing for the tire size/power application. Some instances result in destruction of the aircraft. - Resulted in vehicle movement/sliding across wet, snowy and icy surfaces as a result of improper grip. - Resulted in unwarranted tire damage and/or engine FOD. - Resulted in tertiary damage to other vehicles or ground equipment as a result of being blown about by jet/propeller blast. - Damaged surfaces due to temporary placement of chocks on vehicle surfaces during vehicle movement. - Resulted in personnel sliver/s abrasions (wooden chocks) and cuts (metal chocks) even when chocks were in decent useable condition. - Resulted in varied personnel ground accidents during attempts to use chocks as a temporary work stand. - Lost aircraft "over the side" on carriers.
SE-04	Gun port covers or plugs should be lightweight, 100% effective, and easy to install or store.
SE-05	The geometric aspects of simple maintenance stands, ladders, and work platforms should enable high density stacking for storage and mobility deployments.
SE-06	Non-metallic materials should take preference over metals to enable simple manufacturing and repair by bonding in lieu of weldments and/or mechanical fasteners.
SE-07	The design construction concept and material selection for support equipment structure should not rely or depend upon the use of scheduled maintenance, NDI, or NDT to protect the durability or integrity of the equipment in the operational environment.
SE-08	Support legs, posts, arms for ladders and workstands should contain integral non-skid devices for safe use on ice or snow.
SE-09	Ladders and workstands used in close proximity to air and ground vehicles should contain effective buffers to protect finishes and treatments.
SE-10	Protective finishes and coatings should meet the same ground environmental criteria as defined for air and ground vehicles.
SE-11	Avoid reliance on mechanical fasteners solely to facilitate manufacturing.
SEAT-01	Design personnel seats and padding materials, including the covers and fillers, so they are incapable of creating or emitting toxic fumes or dense smoke when subjected to fire.
SEAT-02	Design personnel seats and padding materials so they are incapable of absorbing and holding fluids.
SEAT-03	Do not use seat and padding materials that can create static electricity in pyrotechnic or combustible fluid environments.
SEAT-04	Design ejection seats so they can be replaced with canopy or escape hatch installed.
SEAT-05	Design ejection seat pyrotechnic devices so they are 100 percent viewable and accessible with seat installed.
SEAT-06	Do not use seat removal as a means of access.
SI-01	Leading edges containing complex integrated antennas or sensors should be interchangeable to enhance repair of battle damage and induced damage.

List of Guidelines (Cont'd)

Guideline Numbers	Guideline
SI-02	Speed brake hinge and actuator attachment hardpoints should enable interchangeability of speed brake(s) and actuator(s) without need for rigging.
SI-03	Parts and assemblies of a given model product or of models of a product in the same series should be interchangeable or replaceable.
SIMP-01	Location and design of all exterior lights should not require protective covers in ground environments.
SIMP-02	Landing and taxi lights should be mounted on landing gear struts or doors to eliminate separate compartments, doors, and retraction/extension mechanisms.
SIMP-03	Speed brake or speed brake cavity should contain integral mechanical locking mechanism for personnel safety.
SKID-01	Design non-metallic floats to be impervious to all fluids used on board the host vehicle.
SKID-02	Design non-metallic floats to be highly resistant to scuffing and abrasion.
SKID-03	Design non-metallic floats with a color-coded inner ply to readily denote when maximum abrasion limits have been reached.
SKID-04	Design pneumatic floats with an integral air gage located adjacent to the air fill fitting.
SKID-05	Design metallic and composite floats and skids to the same environmental criteria as the airframe, including finishes.
SKID-06	Use non-skid finishes on the upper surfaces of skids and floats for use as steps and walkways.
SKID-07	Design floats with simple drain provisions for each compartment.
SURV-01	Design containers used for dinghy stowage to be structurally capable of containing the dinghy within the event of unintentional or uncommanded inflation.
SURV-02	Provide crew stations, crew compartments, and operator areas containing dinghies as emergency equipment with a suitable tool for puncturing or cutting the dinghy in the event of inadvertent inflation. Locate the tool so that access is assured during dinghy inflation.
SURV-03	Survival gear containerization or storage should have a minimum twelve-month period between scheduled tests, checks, or replacements.
SURV-04	Do not seal battery power or battery-operated devices in survival packages or containers. When this guideline cannot be followed, provide a remote way of ascertaining the status or condition of the battery.
SURV-05	Design survival equipment pods intended for external carriage or suspension to meet the same environmental and operational criteria as the host vehicle structure.
T-01	Do not locate pyro, gas, and air (PGA) control system exhaust exits: <ul style="list-style-type: none"> - In proximity to safe, arm, or servicing areas, - Adjacent to auxiliary inlets, - In close proximity to crew boarding areas, weapons, emergency ingress/egress areas, and optics or optical glass.
T-02	Design pyro type thruster exits associated with emergency use or backup with simple exit closure devices to identify if a thruster has been fired.
T-03	Provide protective screens for PGA exits that normally remain open to prevent intrusions from fowl or wildlife.
T-04	Provide protective closure provisions for PGA exits located or oriented to exposure from the elements.

List of Guidelines (Cont'd)

Guideline Numbers	Guideline
T-05	Design single-shot (one time use) type thrusters with a minimum 6-year shelf life and a 7-year installed life.
TCR-01	For each transmission, clutch, or rotor, provide a dedicated lubricating oil supply tank and system that is not shared with any other oil lubricating system.
TCR-02	Provide each dedicated oil supply system with a separate servicing port/interface, pressure gauging, and quantity gauging system as applicable.
TCR-03	Use a singular gage capable of reading pressures or quantities from two or more lubricating systems in preference to individual gages.
TCR-04	Provide each dedicated system with an on-board spectrometric oil analysis program capability, separate oil filter, and separate oil, fuel, or air heat exchanger capability.
TCR-05	Use the item's self-contained oil system to provide drive/interface spline lubrication, if required.
TCR-06	In complex units, use different tracer elements in multiple gears, plates, discs, etc., so the source of wear can be easily identified by spectrometric oil analysis monitoring units.
TCR-07	Design mechanical interfaces to transmissions, clutches, and rotors so that the respective unit can be replaced without the need for rigging.
TCR-08	Incorporate vibration pick-up sensors to isolate the respective unit from other potential sources of vibration, and to enhance the prognostic potential for monitoring equipment health.
TP-01	Locate Input/Output (I/O) test points and associated readouts in close proximity to each other so that one person can perform testing.
TP-02	Protect test points against the environment and from induced contamination.
TP-03	Protect test points from outside signal generation.
W-01	Hat section type structural stiffeners with sufficient cross sectional area should be considered as a routing tunnel for wiring and coax.
WBAY-01	Equipment bays and compartments should not require installation of special cavity fillers when equipment is not installed.
WBAY-02	Pylon-to-wing electrical or plumbing interfaces should have automatic close-out covers when pylon is jettisoned or not installed.
WBAY-03	The method and position of the pylon-to-wing gap scale should not form a drip edge for leakage into the pylon cavity.
WBAY-04	The gap treatment should be a permanent installation on the pylon, wing, or both, not a separate seal.
WBAY-05	Gap treatment should not interfere with or be damaged by existing pylon handling support equipment.
WBAY-06	Pylon rigging should not be required for gap seal control.
WBAY-07	Gap seal should not degrade interchangeability of pylon.
WBAY-08	Gap seal and treatment should be fully compatible with steam from carrier catapults.
WBAY-09	Gap seal/pylon should not cover or hamper access to low point wing drains.
WBAY-10	No loose hardware should exist before or after pylon is installed.
WBAY-11	Gap seal should match pylon and wing/fuselage surface impedance.

List of Guidelines (Cont'd)

Guideline Numbers	Guideline
WBAY-12	Pylon-to-store/weapon gap seal should permit visual and physical access during loading for all interfaces between bomb rack-to-store, bomb rack-to-launcher, and launcher-to-store.
WBAY-13	Pylon-to-store/weapon gap seal should not interfere with automatic sway brace function.
WBAY-14	Pylon-to-store/weapon gap seal should permit physical access to lanyards.
WBAY-15	Gap seals should not hinder pilot or ground crew preflight inspection.
WBAY-16	Gap seals should not degrade loading while wearing arctic or chemical, biological, or radiation protective clothing.
WBAY-17	Special coatings or conductive paints on pylons, launchers, racks, launchers, tanks, pods, etc. should have the durability to withstand contact with support stands/cradles during storage.
WBAY-18	The proximity of the gun firing barrel to structure should be such that structural furrows or channels are not required for projectile clearances during firing.
WBAY-19	Frangible gun ports should take preference over mechanized gun port doors.
WBAY-20	Gun plugs required solely to maintain a given signature level should be capable of on-board stowage for use only when a threat requires their presence.
WBAY-21	Coatings and finishes in the area of gun barrels should be durable to withstand the effect of exiting projectile shockwaves.
WBAY-22	The proximity of the gun blast deflector to structure should not require reliance on high-temperature paints or coatings to protect the structure.
WIND-01	Optical window materials should be scratch resistant, easy to clean, and dissipate electrostatic charges.
WIND-02	Optic windows should be located for ease of inspection, cleaning, and induced damage potential from personnel or support equipment.
WIND-03	Window locations should minimize the effects of contamination by salt spray, bugs, oils, fuels, and icing.
WIND-04	Window, canopy, and windshield material should be designed to withstand the effects of sandstorms in the ground environment and the effects of rain and hail during thunderstorm penetration in the airborne environment.
WIND-05	Design interior surfaces to be reachable for cleaning without reliance on hinging, equipment removal, or use of support equipment.
WIND-06	Do not locate windows in the proximity of rooster tails created by wheels/tires passing through water or slush.
WIND-07	Use materials that are highly resistive to thermal shock.
WIND-11	For dome-shaped optic window concepts, the dome should be easily removable for cleaning without affecting LO integrity.
WIND-12	Design EO windows and optics to be interchangeable among the same air vehicle types or same ground vehicle types.
WIND-13	The combination of material layers and coatings for optics and windows should be such that static charge buildup for worst case conditions should not exceed 10,000 volts.
WIND-14	Exterior lights should permit simple and rapid bulb replacement without disturbing LO treatments.
WIND-15	Design light covers and lenses to be sufficiently durable so that protective covers are not needed during maintenance.
WIND-16	Lens shape should enhance LO capability to reduce need, care, and expense for special coatings.

List of Guidelines (Cont'd)

Guideline Numbers	Guideline
WT&B-01	Wheel bearings should be lubricated by oil-bath concepts and should not be integral with the wheel assembly.
WT&B-02	Brake-wear indicating pins should be highly visible during day and night operations.
WT&B-03	Provide a parking brake capability to simplify wheel and tire replacements and to reduce operator fatigue during prolonged engine ground operations.
WT&B-04	Tires should contain a color band to provide easy visual indication that maximum wear has been achieved.
WT&B-05	Locking ring type concepts for retaining wheel halves should be given preference over multiple tie bolts.
WT&B-06	Locate brake anti-skid system components, including brake control valves, for easy access in low-vibration environments.
WT&B-07	Landing gear caution and warning systems should contain both initiated and periodic BIT and be capable of fault-isolating to each component in the system.
WT&B-08	Do not use microswitches (mechanical) in gear caution and warning systems.
WT&B-09	Brake clips, end plates, retainers, etc. used to build up wheel, tire, and brake assemblies should not be capable of reverse or improper installation.
WT&B-10	No hubcaps or covers should be installed in a manner that prevents full visual viewing of the wheel retaining nut. In instances where this may not be possible, the design should ensure that the hubcap/cover cannot be installed unless the retaining nut is properly installed.
WT&B-11	Wheel axle nuts should contain integral retention devices or safetying features. In rare instances where this cannot be accomplished, a bolt and self-locking nut should be used. Locking rings and similar devices that can fail and cause FOD should be avoided.
WT&B-12	Avoid the use of rivets to retain pressure pads, clips, brackets, and similar items in wheel/brake assemblies unless: <ul style="list-style-type: none"> - Rivet failure will not permit a part or item to fall into the brake disc/pad area, and - Exceptional quality control can be assured during manufacture of the part or rivet attachments, and - Frequent scheduled inspections will not be imposed to protect product integrity or reliability.
WT&B-13	Emergency brake handles should not be similar in shape or color as other handles nor should they be located in close proximity to such other handles.
WT&B-14	Wheel assemblies should contain built-in dial type pressure gages.
WT&B-15	Anti-skid and anti-lock brake systems should contain periodic and initiated BIT. All components, including speed sensors, comparators, wiring, connectors, control boxes, etc., should be included in the BIT system.
WT&B-16	Do not use potting compounds for electrical connector environmental protection because it tends to revert and significantly increases repair time.
WT&B-17	Electrical connector environmental protection should be capable of withstanding water pressure streams up to 120 psi encountered during decontamination, wash, etc.
WT&B-18	Route brake lines so that line failure will not occur due to tire blow out or separation of recapped treads.

Guidelines by Category

Category No.	Category Title	Guideline No.	Guideline
2.01	Accessibility	A-01	Seal equipment bays and compartments against the environmental elements including all types of servicing fluids used for the vehicle, all types of anti-ice and de-ice fluids, and all types of fluids used for chemical, biological, or nuclear decontamination.
		A-08	Plumbing penetrations into a compartment should not be on a vertical axis due to difficulty in making or breaking vertically-oriented connections. When compartment access is from the bottom, vertically-oriented connections can allow fluid to leak onto the maintainer. When access is from the top, such connections can allow foreign matter to enter the line. Use horizontal penetrations whenever possible.
		A-09	Any heat or temperature sensitive structure within a compartment should contain heat-sensitive tape or appropriate heat sensor for easy indication of over-temperature excursions.
		A-10	Provide a sufficient number of compartment fluid drains to ensure fluid drainage for varying aircraft static attitudes and varying terrain slopes for ground vehicles.
		A-11	Locate compartment electrical penetrations close to the access opening for ease of sight, probing, repair, and to eliminate fluid soaking, wicking, or contamination.
		A-12	Locate compartment electrical penetrations far enough from the access opening to prevent damage resulting from improper (over-length) panel fasteners.
		A-13	Two-sided or two-surfaced access should not be required for access to equipment interfaces and hardpoints. The term two-sided infers top/bottom, left/right, front/back, or combinations thereof.
		A-14	Do not locate nutplates or gang channels in inaccessible areas that would require extensive disassembly or equipment removal to gain access.
		A-16	Structural design should provide good access to corrosion-prone areas for inspection and treatment.
		A-17	All structural fasteners in an access door or panel should be of identical grip and diameter. In rare cases where this is not possible, fasteners of different grip must have different diameters to prevent a shorter fastener being substituted for the correct, longer fastener.
		A-18	Use transparent windows, quick-opening covers, or openings without any cover to permit quick visual inspections where needed.
		ARM-01	For an aircraft, the fuselage lower shear moldline should be no less than 38" above the ground when external weapons only will be carried on the fuselage.
		ARM-02	For an aircraft, the fuselage lower shear moldline should be no less than 50" above the ground when internal weapons will be carried in the fuselage and weapon bay door widths exceed 22".
		ARM-03	Locate fuselage weapon bays a minimum of 18" from the nose landing gear and main landing gear of an aircraft.
		ARM-04	No single weapon/store mounted on a transporter should intrude into the service/turnaround envelope of another station.
		ARM-05	All servicing and turnaround functions (including movement envelopes) should be outside the gun firing envelope.
		ARM-06	The relationship of the nose landing gear to the main landing gear should not restrict the positioning of weapon transporters under the fuselage of an aircraft.
		ARM-12	Missile and weapon cooling provisions should have the capability to be serviced in-situ or rapidly replaced as a pre-charged assembly.
		CONT-06	Design all pulleys and brackets associated with cable installations so they are accessible by a 75 percentile male hand.
		CREW-04	Avoid wiring, coax, and plumbing penetrations through the floor of crew cabs, operators' compartments, crew stations, cockpits, and passenger compartments.
		CREW-05	Structural instrument panels, dashboards, and control panels should be modularized for easy and adequate access to all interfaces, to simplify manufacturing, and to reduce maintenance-induced problems.
		CREW-10	Design cameras, recorders, and sensors to be fully interchangeable and quickly replaceable.
		EC-08	Locate and position electrical connectors such that all pin identification for either half can be easily seen.
		EC-09	Electrical connectors selected for critical applications on ground vehicles should be both accessible and capable of being connected disconnected by a fifty percentile gloved male hand.

Guidelines by Category (Cont'd)

Category No.	Category Title	Guideline No.	Guideline
2.01	Accessibility	EC-10	Separation between grouped electrical connectors should be sufficient to ensure make or break of any connector by a fifty percentile gloved male hand. Where this is not possible, an alternate method should be used such as the use of stand-offs, long-shelled connectors alternated with standard connectors, 180-degree connectors alternated with 90-degree connectors, or innovative equivalents.
		EC-13	Electrical, electronic, and coaxial interfaces between fixed and moveable surfaces should contain quick disconnects to simplify replacement of the moveable surface or the electronic module.
		EC-14	Scoop proof connectors should be used throughout unless their use would require an increase in the volume of the aircraft, in which case deviations will be considered on an individual basis.
		EC-15	The removal or replacement of electronic equipment should not require the removal of any other piece of equipment or armament.
		ECS-01	Design so that equipment servicing status are accessible and readable from the ground level for air vehicles and from the operator's position for ground and water vehicles.
		ECS-05	Access, removal, and installation of all type filter elements should be possible without removing the assembly or disconnecting any filter package interfaces.
		ECS-21	Do not locate ground cooling or circulation fans that operate at high noise levels in operator, crew, or passenger compartments.
		ECS-28	Install and orient air supply and distribution ducts so they clear all access openings and equipment removal envelopes.
		ENG(G)-01	Provide access to all engine mounts for ground vehicles so that hoisting or crawling under the vehicle is not required.
		ENG(G)-03	Design hard points for hoisting or positioning the engine during installation and removal to be integral to the engine and capable of hoisting and supporting a fully-built-up engine package.
		ENG(G)-04	Do not use downward engine removal concepts that require jacking or hoisting of the ground vehicle.
		ENG(G)-05	Use concepts for removing ground vehicle engines from the front, rear, or side rather than from overhead (using hoisting).
		ENG(G)-06	The distance between the engine and firewall should ensure the access envelopes to lines, fittings, wiring, and adjustments will accommodate the 75 percentile male hand.
		ENG(G)-07	The distance between the cooling fan and radiator core should ensure that access envelopes will not require removal of the core.
		ENG(G)-08	The interface of the engine assembly to the engine compartment and structure should be designed to ensure all spark plugs, glow-plugs, and igniters can be replaced within 30 minutes elapsed time.
		ENG(G)-10	Design attaching hardware for all mechanical engine-to-vehicle interfaces to be captive and with integral safeties.
		ENG(G)-12	Provide a clear and viewable access envelope to fuel and oil filters.
		ENG(G)-13	Locate fuel filters to ensure no safety hazard will exist due to residual fuel during filter change.
		ENG(G)-14	Access envelopes to fuel and oil filters should not be in close proximity to exhaust manifolds or cooling system return lines.
		ENG(G)-15	Any single drive belt (excluding timing belts) should be capable of replacement within 30 minutes elapsed time
		ENG(G)-16	Do not locate batteries in the engine compartment. In those instances where this is not possible: - The battery support structure should be of a material that is impervious to acid leakage or boil-over. - The battery support structure should serve as a scupper to collect and direct the acid out of the engine compartment.
		ENG(G)-17	Install simple, lightweight shields over cooling system return lines to protect personnel from hose or line blowout during maintenance.
		ENG(G)-20	Design all firewall fittings, connectors, and penetrations to be fully viewable and directly accessible to the maintainers.
		ENG-05	All engine-mounted air and fluid lines should be located next to the fan case, engine case, or full-length fan duct to ensure quick and simple replacement of accessories and components.
		ENG-12	All engine-mounted accessories must be capable of being removed and installed through the available airframe access openings.

MIL-HDBK-470A

APPENDIX C

Guidelines by Category (Cont'd)

Category No.	Category Title	Guideline No.	Guideline
2.01	Accessibility	ENG-15	Engine removal for aircraft intended to be operated off carriers should be accomplished within the shadow of the aircraft.
		ENG-16	Aircraft jacking should not be required for engine removal.
		ENG-17	Aft engine removal should be an acceptable alternative for USAF aircraft.
		ENG-18	For either downward or aft engine removal, it should be possible to maintain control of the engine on all axis during the entire removal and installation process.
		ENG-19	The minimum clearance between engine and airframe should be 1 inch, including removal and installation.
		ENG-20	Do not locate equipment or components in the engine cavity except for those components associated with the engine or engine installation.
		ENG-21	Do not locate equipment or components in the engine bay cavity in a manner that would require removal or repositioning for engine removal.
		ENG-23	All engine borescope provisions should be accessible with the engine installed and hooked up.
		ENG-24	Replacement of all ignitors should be possible with the engine installed.
		ENG-25	All engine-to-airframe plumbing, wiring, and duct interfaces should be capable of being connected or disconnected by hand, should contain integral safety provisions, and should not require torquing.
		ENG-30	It should not be necessary to close or reinstall engine access doors for engine ground operation up to and including military power.
		ENG-33	Engine access doors and panels and their integral support struts should be capable of withstanding 60 MPH winds in the opened position.
		ENG-34	Identification plates on the engine and all engine-mounted components should be viewable with the engine installed and engine access doors opened.
		ENG-35	No time-change components or scheduled actions should be planned solely to protect component integrity or reliability.
		ENG-45	Provide remote servicing points accessible from the ground to service engine accessories mounted on top of the engine (e.g., oil tanks, gear boxes, generators, etc.) to eliminate climbing upon or atop the host vehicle.
		ENG-52	Incorporate provisions to enable very slow rotation of the fan, compressor, and turbine during borescope inspections.
		EXT-01	Locate Tanks, Pods, Containers, and Devices (TPCD's) so they do not block or restrict access to existing vehicle access or access approach envelopes.
		EXT-05	Design access doors for cargo type TPCD's to be non-load carrying and with simple latches for all doors and panels.
		EXT-06	Design cargo TPCD's to ensure all cargo and equipment can be downloaded and uploaded with the TPCD installed on the host vehicle.
		F-01	Use blind fasteners only where absolutely necessary or where considerable cost can be saved.
		F-02	Minimize access fasteners while making them quick release, easily removed and replaced, and captive.
		F-03	Choose fasteners based on the requirement to operate by hand or with common hand tools rather than special tools.
		F-04	Whenever possible, incorporate barrel type fasteners as opposed to hi-torque fasteners. Failure of Hi-torque fasteners due to stripping are common and a source of potential foreign object damage (FOD).
		FUEL-01	Locate fuel vent and dump masts to ensure exiting fuel will be clear of servicing, loading, arming and safing areas for all types of ground and airborne vehicles.
		FUEL-05	Intersecting of two or more surfaces in a fuel wetted area of less than 90 degrees should be avoided to simplify manufacture and repair.
		FUEL-06	Where maintaining a minimum angle of 90 degrees is not possible, sufficient depth, width, and height should be maintained to provide tool clearances for all tools used in the manufacturing processes and in the operational field repair environment.
		FUEL-07	When feed tanks are designed such that the lower portion of the tank serves as a surge chamber, the top closure deck of the surge chamber should provide the strength to support the weight of a 95 percentile male.
		FUEL-08	The size and number of fuel cell and tank access doors should be sufficient to ensure no wetted area of the cell or tank is beyond a maximum 18" distance from the edge of the access opening. This guideline applies to only non-man rated cells.

Guidelines by Category (Cont'd)

Category No.	Category Title	Guideline No.	Guideline
2.01	Accessibility		
		FUEL-09	All fuel cell or tank access doors not mounted on the exterior surface should contain sealing provisions other than the channel type.
		FUEL-10	Provide access from the wing closure ribs in lieu of the moldline when access is required in close proximity to the wing fold area.
		HF-01	Steps and handholds for all ground vehicles should be parasitic to the surface and capable of safely supporting a 95 percentile male wearing arctic boots.
		HF-02	Locate identification and modification plates for all major structural assemblies and subassemblies so as to be fully visible and legible when viewed through normal access provisions. Avoid the need to remove equipment or components to view the plates.
		HF-03	Provide hoist fittings or hardpoints for hoist fitting attachments that are readily accessible.
		HF-04	Size structural openings into man-rated fuel cells to enable entry by a 75 percentile male.
		HF-05	In designing the vehicle, system, subsystem, and equipment, attempt to satisfy the personnel spectrum from the 5th percentile female to the 95th percentile male.
		HF-09	Develop decals, placards and instruction media around an 8th grade reading level and a 10th grade level of comprehension.
		HOOK-06	Avoid the need to remove the tail hook to facilitate engine access or removal.
		HYD-01	For military combat vehicles having two or more hydraulic power systems, provide a minimum 30-inch spacing between ground power and servicing interfaces to ensure: - Design flexibility in locating and arranging equipment in high-density vehicles such as fighters and helicopters, - Work area separation to enable concurrent service/maintenance on systems, - Systems vulnerability enhancement, - Reduction in turn-around elapsed time due to concurrent servicing capability.
		IN(V)-01	Design inlet door actuators and door actuation mechanisms so they not protrude into the air inlet flow field to eliminate FOD potential.
		IN(V)-02	Do not use loose structural fasteners in the access area to inlet door actuators and mechanisms. Where this guideline cannot be followed, design the actuator door to be accessible only when the inlet doors are fully closed.
		IN(V)-03	For engine inlet bellmouth fairings, use methods of retention other than fasteners. Latches may be considered as an acceptable alternative only if latch-to-panel retention is from the inner mold line.
		IN(V)-04	Design inlet doors and inlet bellmouth fairings to be fully interchangeable to eliminate the need to cut, file, or trim at the engine face.
		IN(V)-06	Use captive fasteners on all access doors forward of the inlet to significantly reduce engine FOD potential.
		IN-01	Low Observable (LO) engine face frames should be within 10 inches of the first stage fan or compressor blades.
		IN-03	Openings throughout the engine face frame should be sufficient to permit minor blending or repair of FOD without removing the engine.
		IN-04	For frames not integral with the engine, frame removal should be achievable from the engine cavity.
		LG-14	All interfaces from the airframe to the struts should be visible and accessible, and not require removal of airframe structure for access.
		LG-23	Design strut fittings for servicing nitrogen or hydraulic fluid to be easily accessible and adjacent to the appropriate strut pressure gage.
		LG-24	Design struts so they can be serviced with clean, dry air in lieu of nitrogen during deployments without affecting the overall reliability.
		LO-03	Equipment and support structure requiring shrouds to reduce radar returns should not cause increases in equipment service/repair time.
		LO-04	Infrequently-accessed structural doors and panels incorporating special coatings or conductive paints should contain provisions for prying the door or panel clear of moldline with standard screwdriver without damage.
		MC-06	Locate, position, orient all plumbing and duct electrical connectors to prevent the need for sequential installation or removal.

Guidelines by Category (Cont'd)

Category No.	Category Title	Guideline No.	Guideline
2.01	Accessibility	MC-07	Maximize areas of constant web thickness in firewalls, carry-through bulkheads, major frames, structural ribs, spars, webs, keels, and close-outs to provide flexibility in locating penetration fittings. Stepped chem milling, stepped machining, stepped composite layup concepts all tend to result in minimal available surface area for penetrations.
		MC-08	All in-line plumbing connections within a fuel tank or cell should be capable of making/breaking the interface by hand, require no torque, contain integral safety locking mechanisms, and should be void of any requirement for safety wire.
		MC-09	All plumbing connections and fittings used for fuel systems should contain integral bonding features to eliminate the need for bonding clamps or jumper cables.
		MC-10	In rare instances where a plumbing run contains complex form or geometry that would require removal of other plumbing or equipment for access, in-line connectors should be incorporated to maintain the integrity of other plumbing or equipment.
		MC-12	All plumbing and connectors containing liquids should be meniscus-free.
		MC-13	In instances where plumbing or connector interfaces cannot or are not keyed for a specific orientation, all identification, markings, cautions, and directions should be placed 360 degrees around the tube or duct.
		MC-14	Where multiple connectors are located in close proximity, ensure (1) a minimum hand tool arc of 120 degrees can be maintained, and (2) stagger fittings to ensure firm coupling interface/hand tool interface can be accomplished without inducing damage to adjacent lines.
		OXY-05	Locate liquid oxygen (LOX) containers in a sealed, dedicated compartment to eliminate need for frequent visual inspections.
		OXY-07	Locate liquid oxygen containers to ensure simultaneous replacement with other turnaround activities.
		P-01	Access door and panel fastener types for airborne vehicles should meet the following criteria: <ul style="list-style-type: none"> - use latches for a frequency of access of 0 to 40 flight hours - use High Strength Quick Release fasteners for a frequency of access of 40-400 flight hours - use structural screws for a frequency of access of 400 flight hours or more
		P-02	Access door and panel fastener types for surface vehicles should meet the following criteria: <ul style="list-style-type: none"> - use a spring loaded or latch fastener for an opening frequency of daily - use a one quarter turn fastener (or equivalent) for an opening frequency of weekly - use screws or bolts for all other cases
		P-03	All doors and panels subject to environmental elements should contain form-in-place seals (or equivalent) attached to the door structure, not substructure, to prevent damage during maintenance.
		P-04	Door and panel seals should be compatible with all types of on-board servicing fluids, de-ice and anti-ice fluids, and all fluids used for chemical, biological, and nuclear decontamination.
		P-05	Piano type hinges should not be used on doors or panels because they are subject to wear, corrosion, and sand and fluid entry.
		P-06	Access door and panel devices used to support door in opened position should meet the following criteria: <ul style="list-style-type: none"> - for airborne vehicles, design for 60 knot gust loads (or equivalent jet blast loads) - for ground vehicles, design for 50 mph gust loads
		P-07	Hinged access doors and panels capable of remaining in the opened position should not have sharp edges or corners.
		P-08	Removable access door and panel fasteners should be of identical grip length and diameter.
		P-09	Acceptable door and panel hold-open devices include over-center sheet metal spring, over-center spring link, spring cartridge, support strut, and pinned goose neck hinge.
		P-10	Access doors and panels requiring non-captive fasteners should not be located forward of air inlet ducts or high-energy rotating components (e.g., prop fans, engine cooling fans, etc.).
		P-11	Access doors and panels should be interchangeable as justified by operation and support costs or life cycle costs.
		PYRO-19	Locate built-in grounding receptacles clear of weapon approach and loading envelopes.
		PYRO-20	Weapon bay doors, when opened, should not block or restrict access to other servicing points.

Guidelines by Category (Cont'd)

Category No.	Category Title	Guideline No.	Guideline
2.01	Accessibility	PYRO-24	Ammo loader interface should not be less than 30" nor more than 50" above the ground to ensure loading can be accomplished by a wide range of percentiles wearing chemical or biological protective gear.
		PYRO-25	Gun loading and servicing should be possible concurrently with all other weapon loading and servicing activities to minimize the elapsed downtime.
		PYRO-29	Provide quick mechanical over-travel (no power) for weapon bay doors to maximize the weapon/store loading envelope.
		PYRO-30	Ensure weapon bay door arc (both normal and over-travel) does not block or intrude into adjacent service points or envelopes.
		PYRO-32	Provide sufficient longitudinal clearance between weapon bays to enable simultaneous loading of two bays.
		PYRO-33	Provide sufficient lateral clearance between weapon bays to enable simultaneous loading of two bays.
		PYRO-35	Suspension system should permit any single weapon or store to be loaded by a two man crew.
		PYRO-36	Suspension system design and spacing should enable any combination of eight weapons to be loaded by two two-man crews within the refueling time of the vehicle (excludes nuclear weapons).
		PYRO-40	All weapon and store loading functions should be within the percentile range of 5% female to 95% male standing at ground level.
		SABCH-01	Do not locate auxiliary air inlets, sensors, access doors, or drains in boundary bleed areas.
		SEAT-04	Design ejection seats so they can be replaced with canopy or escape hatch installed.
		SEAT-05	Design ejection seat pyrotechnic devices so they are 100 percent viewable and accessible with seat installed.
		SEAT-06	Do not use seat removal as a means of access.
		SIMP-01	Location and design of all exterior lights should not require protective covers in ground environments.
		SIMP-02	Landing and taxi lights should be mounted on landing gear struts or doors to eliminate separate compartments, doors, and retraction/extension mechanisms.
		SIMP-03	Speed brake or speed brake cavity should contain integral mechanical locking mechanism for personnel safety.
		TP-03	Protect test points from outside signal generation.
		WBAY-12	Pylon-to-store/weapon gap seal should permit visual and physical access during loading for all interfaces between bomb rack-to-store, bomb rack-to-launcher, and launcher-to-store.
		WBAY-16	Gap seals should not degrade loading while wearing arctic or chemical, biological, or radiation protective clothing.
		WIND-05	Design interior surfaces to be reachable for cleaning without reliance on hinging, equipment removal, or use of support equipment.
		WIND-11	For dome-shaped optic window concepts, the dome should be easily removable for cleaning without affecting LO integrity.
		WIND-14	Exterior lights should permit simple and rapid bulb replacement without disturbing LO treatments.
		WT&B-06	Locate brake anti-skid system components, including brake control valves, for easy access in low-vibration environments.
	Fasteners	A-02	Equipment bay and compartment structure should be bonded, co-cured, welded, machined, or combinations thereof to eliminate or minimize the use of mechanical fasteners.
		A-03	All equipment bay and compartment structural flanges and stiffeners should be external to the compartment to maximize the volume available for equipment installation and arrangement.
		A-04	Use stiffening beads in lieu of flanges to the maximum extent to enhance compartment volume and simplify repairs.
		A-05	Stiffening beads should have the convex surface toward the compartment to eliminate fluid traps.
		A-06	Keep all machined compartment frames, webs, and closure panels to a constant thickness (e.g., not stepped or tapered) to ease simplicity of fluid or electrical penetrations and ease and simplicity of structural repair.
			Hardpoints (structural attachment and load bearing areas) within a compartment to assist in equipment mounting or support should not be integral with the machined part. Hardpoints should be parasitic to enable quick repair in case of wear or damage in lieu of precise ream/bush repair typical of machined hardpoints.
		CONT-01	Control rods should use Boyd or impedance type bolts (or equivalent) to eliminate the need for cotter pins or safety wire.
		ECS-16	All components contained in the systems, including all attaching brackets and supports, should use hex-head self-locking bolts for ease and simplicity of installation.

Guidelines by Category (Cont'd)

Category No.	Category Title	Guideline No.	Guideline
2.02	Fasteners		
		ENG(G)-02	Use torque-limiting bolts or torque washers as engine mount attaching hardware to eliminate the need for torque wrenches.
		ENG-41	Use captive fasteners containing self-locking features to attach the nose dome to the engine face. The fasteners should be fully viewable during engine face FOD inspections.
		EXT-05	Design access doors for cargo type TPCDs to be non-load carrying and with simple latches for all doors and panels.
		F-01	Use blind fasteners only where absolutely necessary or where considerable cost can be saved.
		F-02	Minimize access fasteners while making them quick release, easily removed and replaced, and captive.
		F-03	Choose fasteners based on the requirement to operate by hand or with common hand tools rather than special tools.
		F-04	Whenever possible, incorporate barrel type fasteners as opposed to hi-torque fasteners. Failure of Hi-torque fasteners due to stripping are common and a source of potential foreign object damage (FOD).
		FUEL-03	Structural bolts, screws, and fasteners should not penetrate into integral fuel cells or tanks other than those used for access door attachment.
		FUEL-06	Where maintaining a minimum angle of 90 degrees is not possible, sufficient depth, width, and height should be maintained to provide tool clearances for all tools used in the manufacturing processes and in the operational field repair environment.
		FUEL-11	Through-the-tank fasteners should not be used for fuel cells or tanks in areas where a leak path could be established into an inaccessible portion of the vehicle.
		HYD-06	Mount hydraulic pumps to the gear box flange with v-band clamps containing a torq-set or equivalent fastener.
		IN(V)-03	For engine inlet bellmouth fairings, use methods of retention other than fasteners. Latches may be considered as an acceptable alternative only if latch-to-panel retention is from the inner mold line.
		IN(V)-06	Use captive fasteners on all access doors forward of the inlet to significantly reduce engine FOD potential.
		LG-04	Do not use Beryllium and Beryllium base alloys in any location subject to wear or corrosive atmospheres or in installations where machining may be required.
		LG-05	All bolts or similar threaded means used as adjustable stops should be positively retained in the adjusted reference without reliance on jam nuts, cotter pins, or safety wire.
		MC-01	All clamps should contain torque-set or torque-limiting connections to prevent clamp or component failure due to over-torque. Clamp installation call outs should not depend on special tools to establish the required torque values.
		MC-02	Avoid the use of cotter pins, safety wire, safety clips, and similar devices to prevent maintenance-induced events leading to ground vehicle accidents or loss of air vehicles.
		MC-03	All tubing connections and interfaces should use rosan/dynatube (or equivalent) to (1) enable connect or disconnect with one hand, one tool, (2) eliminate the need to safety the connection, (3) provide a superior seal, and (4) negate need to reposition line(s) during component replacement.
		MC-04	No trombone type, flared tube type, or piloted line type interfaces should be used to avoid the need for removal or repositioning during equipment removal.
		MC-05	Avoid potential foreign object traps during manufacturing or operational maintenance by eliminating vertical penetrations of plumbing/fittings into tanks, compartments, or cells
		P-01	Access door and panel fastener types for airborne vehicles should meet the following criteria: - use latches for a frequency of access of 0 to 40 flight hours - use High Strength Quick Release fasteners for a frequency of access of 40-400 flight hours - use structural screws for a frequency of access of 400 flight hours or more
		P-02	Access door and panel fastener types for surface vehicles should meet the following criteria: - use a spring loaded or latch fastener for an opening frequency of daily - use a one quarter turn fastener (or equivalent) for a opening frequency of weekly - use screws or bolts for all other cases
		P-06	Access door and panel devices used to support door in opened position should meet the following criteria: - for airborne vehicles, design for 60 knot gust loads (or equivalent jet blast loads) - for ground vehicles, design for 50 mph gust loads

Guidelines by Category (Cont'd)

Category No.	Category Title	Guideline No.	Guideline
2.02	Fasteners	P-10	Access doors and panels requiring non-captive fasteners should not be located forward of air inlet ducts or high-energy rotating components (e.g., prop fans, engine cooling fans, etc.).
		R-01	Large radomes wherein the combination of the diameter and length exceeds 60" should be top-hinged. Hinge should be load-carrying to reduce radome retention fastener count.
		SABCH-02	All flush type structural screws should have identical head drives for the entire vehicle.
		SABCH-03	All non-flush type structural screws should have identical head drive recesses for the entire vehicle.
		SABCH-04	Special high strength bolts, such as twelve-point heads, should be fully justified from standpoint of the cost of ownership and effectiveness.
		SABCH-05	Structural design should avoid the reliance on blind fasteners unless fully supported by cost, weight, schedule, and effectiveness analysis.
		SABCH-06	Structural design should avoid the potential of dissimilar material or fastener corrosion.
		SABCH-07	No structural fasteners should be used that require special tools for installation.
		SABCH-08	Taper pins should be threaded and retained with self-locking hardware.
		SABCH-09	Pins and collars (lockbolts) should only be used in applications which do not normally require removal.
		SABCH-10	Do not use lockbolts in composites.
		SABCH-12	Avoid tapping threads into structural members. Use of heli-coil type or similar insert concepts is permissible.
		SABCH-14	No structural fastener intended to carry shear or tension loads should be smaller than 1/4" diameter (.25").
		SABCH-16	Wing-to-fuselage attachment should give preference to tension ties over shear ties to improve overall volumetric efficiency.
		SE-06	Non-metallic materials should take preference over metals to enable simple manufacturing and repair by bonding in lieu of weldments and/or mechanical fasteners.
		SE-11	Avoid reliance on mechanical fasteners solely to facilitate manufacturing.
WT&B-05	Locking ring type concepts for retaining wheel halves should be given preference over multiple tie bolts.		
WT&B-11	Wheel axle nuts should contain integral retention devices or safetying features. In rare instances where this cannot be accomplished, a bolt and self-locking nut should be used. Locking rings and similar devices that can fail and cause FOD should be avoided.		
WT&B-12	Avoid the use of rivets to retain pressure pads, clips, brackets, and similar items in wheel/brake assemblies unless: - Rivet failure will not permit a part or item to fall into the brake disc/pad area, and - Exceptional quality control can be assured during manufacture of the part or rivet attachments, and - Frequent scheduled inspections will not be imposed to protect product integrity or reliability.		
A-07	Paint equipment bay and compartment interiors a high gloss white to maximize lighting reflectivity, visibility, and rapid leak detection capability.		
A-10	Provide a sufficient number of compartment fluid drains to ensure fluid drainage for varying aircraft static attitudes and varying terrain slopes for ground vehicles.		
ARM-01	For an aircraft, the fuselage lower shear moldline should be no less than 38" above the ground when external weapons only will be carried on the fuselage.		
ARM-02	For an aircraft, the fuselage lower shear moldline should be no less than 50" above the ground when internal weapons will be carried in the fuselage and weapon bay door widths exceed 22".		
ARM-09	Weapon and store ejectors containing adjustable pitch control devices should ensure devices are easily accessible and adjustments are Murphy-free.		
2.03	Human Factors (including Anthropometric Considerations)		

Guidelines by Category (Cont'd)

Category No.	Category Title	Guideline No.	Guideline
2.03	Human Factors (including Anthropometric Considerations)	CARGO-01	<p>Ground vehicles with storage bays or compartments accessible from outside the vehicle should:</p> <ul style="list-style-type: none"> - Have the door sill located no lower than knee height to accommodate a wide range of percentiles while standing. - Ensure door handles are flush with outer surface to protect personnel. - Contain goose neck hinges to protect the hinge from the elements. - Contain peripheral door seals that will protect against blowing sand entry at 50 mph. - Ensure door can be opened with transport tie downs installed. - Ensure door opening envelope does not intrude into the opening envelope of an adjacent door. - Contain simple sheet metal hold-open spring or mechanism. - Ensure floor of bay or compartment is flush with sill to simplify cleanout and drainage. - Ensure door unlocking and opening mechanism can be actuated by a 95 percentile male hand while wearing arctic gloves. - Contain 15 percent added volume for density growth.
		CARGO-02	<p>Ground vehicles with small exterior storage bays or compartments containing emergency equipment or supplies should:</p> <ul style="list-style-type: none"> - Be located at chest height of the 50 percentile male. - Contain unlatching mechanisms activated by pushing inward on the door. - Meet all other generic bay and compartment requirements.
		CBR-01	<p>Orient all vehicle liquid servicing fittings to ensure fluids will not come in contact with protective garb during connect/disconnect activities.</p>
		CBR-02	<p>Ensure vehicle overboard passive liquid drains are clearly marked or visible to enable personnel to remain clear of area.</p>
		CBR-03	<p>Design fuel cell drains so they can not be activated in a manner that would allow fuel to come in contact with a protected hand.</p>
		CBR-04	<p>Design emergency ingress provisions so they can be activated by a 95 percentile male wearing full protective chemical or biological protection gear.</p>
		CBR-05	<p>Size rescue doors, panels, and "cut here" areas to accommodate the 95 percentile shoulder width wearing full protective chemical or biological protection gear.</p>
		CBR-06	<p>Consider the reduction in peripheral vision resulting from wearing chemical or biological protection gear when designing intended fire paths and crash rescue paths into a vehicle.</p>
		CC-11	<p>Orient spare wires and cable pigtails along the outer diameter or periphery of connectors to make access easier.</p>
		CC-12	<p>Build up and assemble straight and angle connector shells or back shells in a manner that ensures that wire or cable strain or wear is not possible.</p>
		CONT-01	<p>Control rods should use Boyd or impedance type bolts (or equivalent) to eliminate the need for cotter pins or safety wire.</p>
		CONT-02	<p>Do not use metal control cables for vehicles that will operate in salt water or salt air environments.</p>
		CONT-03	<p>Use control rods rather than control cables for non-complex applications and non-complex routing within the vehicle.</p>
		CONT-04	<p>Use control cables rather than control rods for most complex applications.</p>
		CONT-05	<p>Route cables so that 100 percent of a cable will be viewable for inspection.</p>
		CONT-06	<p>Design all pulleys and brackets associated with cable installations so they are accessible by a 75 percentile male hand.</p>
		CREW-06	<p>Film magazines, tapes, and removable modules should permit considerable handling without reliance on special support equipment protection.</p>
		CREW-09	<p>Crew and operator station cassettes or magazines should be capable of being removed and installed with one hand while the operator or air crew is seated and strapped in.</p>
		CREW-11	<p>Design cameras, lenses, reconnaissance pods, aiming devices, and related equipment so they can be reconfigured by one individual.</p>
		EC-16	<p>Select connectors so that contacts on the "live" or "hot" side of the connection are socket type rather than pin type to minimize personnel hazard and to prevent accidental shorting of live circuits.</p>
		EC-17	<p>Whenever possible, use self-locking connector plugs of a type not requiring safety wire.</p>
		EC-20	<p>Use quick disconnect connectors where allowed and identify all pins on each connector.</p>

Guidelines by Category (Cont'd)

Category No.	Category Title	Guideline No.	Guideline
2.03	Human Factors (including Anthropometric Considerations)	EC-21	Locate connectors far enough apart so that they meet specified requirements.
		EC-22	All connectors should be keyed differently with aligning pins that extend beyond the electrical pins. Connector pins and sockets should engage after key position is entered.
		EC-23	Design connectors so that plugs are cold and receptacles are hot.
		EC-24	Use electrical connectors that incorporate alignment key-ways to reduce incidents of damage due to improper engagement.
		EC-25	Use positive locking, quick disconnect electrical connectors to save man-hours, prevent foreign object damage (FOD) and decrease the chance of personal injury.
		EC-26	Avoid using identical electrical connectors in adjacent areas.
		ECS-01	Design so that equipment servicing status are accessible and readable from the ground level for air vehicles and from the operator's position for ground and water vehicles.
		ECS-02	Do not locate equipment servicing points in crew, passenger, or operator areas.
		ECS-03	Heat exchangers using hot liquids as the heat source should not be located inside the compartments used for operator, crew, or passengers.
		ECS-04	Plumbing, lines, or hoses containing hot liquids, toxic gases or liquids should be external to operator, crew, or passenger stations.
		ECS-18	Avoid the use of insulation blankets containing polyvinyl for any application due to the dense smoke and toxic fumes if burned or subjected to high temperature bleed air leakage.
		ECS-26	Design and integrate components whose proper operation depends on the direction of flow such that they cannot be incorrectly installed.
		EDECOM-01	Provide surface sensors on equipment located in compartments containing louvers, screens, flush inlets, or similar openings to the environment to indicate the presence of chem/bio contaminants.
		EDECOM-02	Provide integral sensors (viewable from the exterior) for equipment subject to internal forced-air cooling from outside or external air to indicate the presence of contaminants.
		EDECOM-03	Design equipment surfaces and structure to be compatible with all decontamination agents and methods.
		EDECOM-04	Provide passive overboard drains in compartments subject to decontamination processes to void the area of contaminants.
		EDECOM-05	Provide hoist, lift or transport handles for equipment requiring removal from the host vehicle for decontamination. In instances where this may not be practical, design the equipment with hardpoints for attaching parasitic carrying provisions
		ENG(G)-06	The distance between the engine and firewall should ensure the access envelopes to lines, fittings, wiring, and adjustments will accommodate the 75 percentile male hand.
		ENG(G)-07	The distance between the cooling fan and radiator core should ensure that access envelopes will not require removal of the core.
		ENG(G)-10	Design attaching hardware for all mechanical engine-to-vehicle interfaces to be captive and with integral safeties.
		ENG(G)-11	Use "torq-set" type clamps or equivalent in all cooling system hose interfaces to eliminate torque wrenches and the potential for error.
		ENG(G)-12	Provide a clear and viewable access envelope to fuel and oil filters.
		ENG(G)-13	Locate fuel filters to ensure no safety hazard will exist due to residual fuel during filter change.
		ENG(G)-14	Access envelopes to fuel and oil filters should not be in close proximity to exhaust manifolds or cooling system return lines.
		ENG(G)-19	Paint engine compartments gloss white to enhance light reflectivity and enhance fluid leak detection.
		ENG(G)-20	Design all firewall fittings, connectors, and penetrations to be fully viewable and directly accessible to the maintainers.
		ENG-07	Plumbing and wiring spanning two or more engine modules should contain in-line disconnects to enhance and simplify engine modularization.
		ENG-17	Aft engine removal should be an acceptable alternative for USAF aircraft.
		ENG-19	The minimum clearance between engine and airframe should be 1 inch, including removal and installation.

Guidelines by Category (Cont'd)

Category No.	Category Title	Guideline No.	Guideline
2.03	Human Factors (including Anthropometric Considerations)	ENG-25	All engine-to-airframe plumbing, wiring, and duct interfaces should be capable of being connected or disconnected by hand, should contain integral safety provisions, and should not require torquing.
		ENG-26	Locate and position engine overheat and fire warning sensors so that damage cannot occur during engine maintenance or replacement.
		ENG-49	Design engine fuel and oil filters with integral locking features so they can be installed and removed by hand, and require no torquing.
		ENG-50	Design engine fuel and oil filter delta pressure indicators so they can be reset only from within the filter housing.
		EXTING-05	Route and locate all tube, wire, and plumbing interfaces in a manner that prevents induced damage during maintenance.
		EXTING-06	Provide an alternate capability to activate the system remotely from the cockpit/crew station, or operator's position to satisfy emergency situations during vehicle maintenance.
		EXTING-09	Do not locate provisions for overboard venting or dumping of extinguishing agents in areas that could create hazards for personnel.
		FUEL-07	When feed tanks are designed such that the lower portion of the tank serves as a surge chamber, the top closure deck of the surge chamber should provide the strength to support the weight of a 95 percentile male.
		FUEL-08	The size and number of fuel cell and tank access doors should be sufficient to ensure no wetted area of the cell or tank is beyond a maximum 18" distance from the edge of the access opening. This guideline applies to only non-man rated cells.
		HF-01	Steps and handholds for all ground vehicles should be parasitic to the surface and capable of safely supporting a 95 percentile male wearing arctic boots.
		HF-04	Size structural openings into man-rated fuel cells to enable entry by a 75 percentile male.
		HF-05	In designing the vehicle, system, subsystem, and equipment, attempt to satisfy the personnel spectrum from the 5th percentile female to the 95th percentile male.
		HF-06	Recognize that design ingenuity cannot overcome the fact that certain tasks may be outside of the capabilities of females in the lower percentile ranges. Many of these tasks may also be outside the capability of a large portion of the male lower percentile ranges. In designing, proactively recognize these inabilities so the necessary scope and depth of good design tradeoffs can be identified or expanded. The tasks include:
			<ul style="list-style-type: none"> - Manually loading many types of weapons. - Pushing an engine/transport trailer combination. - Handling various large actuators, motors, or generators. - Removing, installing, and handling many built-up wheel and tire assemblies. - Lifting a large percentage of avionics. - Reaching all areas of windshield/canopy surfaces for cleaning. - Moving major support equipment. - Handling tie-down chains. - Pulling or removing pinched chocks. - Lifting tool boxes. - Aiding in pilot rescue. - Safely moving about in high over-the-deck or ground surface winds. - Riding brakes or taxiing aircraft. - Lifting and connecting refueling hoses. - Changing or repairing tank treads. - Handling small ammunition containers. - Achieving high torque values.

Guidelines by Category (Cont'd)

Category No.	Category Title	Guideline No.	Guideline
2.03	Human Factors (including Anthropometric Considerations)	HF-07	Recognize that design ingenuity cannot overcome certain tasks that are not within the capability of the 95 percentile male. In designing, proactively recognize these incapacities so the necessary scope and depth of good design tradeoffs can be identified or expanded. The tasks include: <ul style="list-style-type: none"> - Pulling circuit breakers with a gloved hand. - Achieving good working access inside of many equipment bays and compartments. - Working under air vehicles with lower shears less than 32 inches above the static ground line. - Connecting and disconnecting electrical connectors that are generally considered to be sufficiently spaced. - Recovering a dropped tool from many different bays and compartments. - Preparing many different types of vehicles for operation while wearing arctic clothing or chemical/biological protective gear.
		HF-08	Avoid solely relying on decals, placards, or instruction media to simplify or negate redesign. In rare instances such use of decals, etc. may lead to significant payoffs, the decision should be supported by complete analysis and supporting rationale.
		HF-09	Develop decals, placards and instruction media around an 8th grade reading level and a 10th grade level of comprehension.
		HOOK-02	Design NGT/NGH mechanisms with integral provisions to visually indicate correct hookup/attachment. The indication must be visible during all day and night carrier operations.
		HOOK-03	NGT/NGH mechanisms should not require scheduled visual or NDI type inspections.
		HOOK-05	Design tail hook points so they can not be incorrectly installed.
		HYD-04	For vehicles containing two or more systems with different fluids, use different service fittings and different ground power interfaces for each fluid type.
		IN(V)-07	Ensure that no ground safety pins or streamers are used forward of the inlet or within a 3-foot radius aft of the inlet.
		LG-18	Landing gear ground safety down locks should be an integral part of the overall design. Use or reliance on loose pins (support equipment) should be avoided.
		LG-19	When deemed necessary for the respective design, pilots, flight crews, or operators should have an indication of the downlock status in the cockpit or crew station to avoid the necessity of a flight abort.
		LG-20	Special locks and pins used solely for landing gear ground maintenance safety should be used only in those cases substantiated by cost effectiveness analysis.
		LG-23	Design strut fittings for servicing nitrogen or hydraulic fluid to be easily accessible and adjacent to the appropriate strut pressure gage.
		LG-24	Design struts so they can be serviced with clean, dry air in lieu of nitrogen during deployments without affecting the overall reliability.
		LG-28	Landing gear control handle should have only "up" or "down" detents with no neutral or intermediate positions.
		LG-29	Basic gear design combined with manufacturing tolerances should ensure that no uplock or downlock rigging is required.
		LG-30	Do not use landing gear wells to locate any type of auxiliary air inlet.
		LG-31	Landing gear doors designed to close after gear is extended should be capable of being manually opened on the ground without reliance on electrical or hydraulic power.
		LG-32	Design of landing gear doors normally closed after gear extension should ensure failure modes will not enable uncommanded opening on the ground.
		LG-33	Design of landing gear doors normally left open after gear extension should ensure no failure mode will enable closing on the ground.
		LG-34	Avoid sharp edges and corners on landing gear doors or fairings.
		LG-36	Location of integral wheel jack points on a strut should provide a minimum 6-1/2 inch clearance for positioning the jack with tire ruptured and wheel ground 2 inches off ground.
		LG-40	Nose gear design and selection of nose gear seals should ensure strut will gradually compress while aircraft is being fueled. Sticking struts followed by sudden compressing is highly hazardous to personnel and equipment.
		LG-42	Landing gear struts should contain built-in, dial type pressure gages.

Guidelines by Category (Cont'd)

Category No.	Category Title	Guideline No.	Guideline
2.03	Human Factors (including Anthropometric Considerations)	LG-43	Incorporate low pressure warning sensors in nose landing gear whenever under-servicing of the gear could result in failure to rotate aircraft during takeoff. This feature will eliminate many aborted take-offs, many of which result in blown tires or aircraft leaving the runway.
		LO-02	Avoid scheduled forced inspections or replacement of materials, coatings, or finishes solely to protect either the reliability or the signature.
		LO-03	Equipment and support structure requiring shrouds to reduce radar returns should not cause increases in equipment service/repair time.
		LO-04	Inrequently-accessed structural doors and panels incorporating special coatings or conductive paints should contain provisions for prying the door or panel clear of moldline with standard screwdriver without damage.
		LO-05	Do not locate flush mounted LO screens for auxiliary air inlets and exits in walkway areas unless durability has been proven.
		MC-02	Avoid the use of cotter pins, safety wire, safety clips, and similar devices to prevent maintenance-induced events leading to ground vehicle accidents or loss of air vehicles.
		MC-06	Locate, position, orient all plumbing and duct electrical connectors to prevent the need for sequential installation or removal.
		MC-09	All plumbing connections and fittings used for fuel systems should contain integral bonding features to eliminate the need for bonding clamps or jumper cables.
		MC-12	All plumbing and connectors containing liquids should be meniscus-free.
		MC-13	In instances where plumbing or connector interfaces cannot or are not keyed for a specific orientation, all identification, markings, cautions, and directions should be placed 360 degrees around the tube or duct.
		MC-14	Where multiple connectors are located in close proximity, ensure (1) a minimum hand tool arc of 120 degrees can be maintained, and (2) stagger fittings to ensure firm coupling interface/hand tool interface can be accomplished without inducing damage to adjacent lines.
		NDI-01	Avoid reliance of extensive interpretation by NDI equipment operators to detect structural flaws.
		P-07	Hinged access doors and panels capable of remaining in the opened position should not have sharp edges or corners.
		PERS-01	Group man-machine interfaces manifold-style to enable connect/disconnect in a single action.
		PERS-02	Include an integral, highly visible indicator in a man-machine interface connector to denote connector is seated and locked.
		PERS-03	Design interface connectors so that a distinct action is required by an individual to effect a disconnect. (Excludes airframe-to-ejection seat personnel interfaces.)
		PERS-04	Interfaces should contain an emergency release mechanism that can be activated by rescue personnel with a 95 percentile gloved hand.
		PERS-05	Design emergency interface release mechanisms to be clearly visible under all types of lighting situations.
		PERS-06	Storage bins, compartments, sacks, or bags should be available within the vehicle to store/protect all personal equipment required to conduct operations.
		PERS-07	All flight and ground vehicles should contain one cubic foot minimum storage compartment(s) for various loose and sundry personal items (for each individual).
		PERS-08	Design stowage and mounting provisions for portable air or oxygen containers to withstand 40G crash or impact loads.
		PERS-09	Design portable emergency locator beacons, radio receiver/transmitters, global positioning systems, and similar battery operated devices with integral provisions for determining battery health or status and remaining battery life.
		PYRO-01	Provide the "safe/arm" status to the pilot, crew, or gunner in the cockpit, crew station, or operator station as appropriate.
		PYRO-02	Provide the "safe/arm" status as an external cue discernible from a distance of 10-20 feet.
		PYRO-07	Manual "safe/arm" mechanisms should be well-clear of inlet ducts, propellers, rotors, and similar rotating components.
		PYRO-08	Manual "safe/arm" mechanisms should be well-clear of engine exhausts, fuel/toxic vents, fluid drains, control surface deflection envelopes, and rescue path envelopes.
		PYRO-09	Provide positive, Murphy-proof locking detents for both the "safe" and "arm" positions of mechanical mechanisms.

Guidelines by Category (Cont'd)

Category No.	Category Title	Guideline No.	Guideline
2.03	Human Factors (including Anthropometric Considerations)	PYRO-10	Provide a numerical maintenance code on maintenance panels or maintenance recorder/memory systems to denote the "safe/arm" status for each weapon or store.
		PYRO-17	In rare instances where use of CADs may be required, a positive indication to denote "cartridge installed" should be provided.
		PYRO-18	Mechanical "safe/arm" mechanism design should enable activation by a 95 percentile male wearing arctic mittens.
		PYRO-21	Weapon bays should contain internal lighting controlled by a separate switch that is only functional when doors are open
		PYRO-22	A "rounds remaining" status should be available at the gun loading interface, maintenance panel, or cockpit/crew station/operator station.
		PYRO-23	Crew size for full ammo load should not exceed two persons.
		PYRO-24	Ammo loader interface should not be less than 30" nor more than 50" above the ground to ensure loading can be accomplished by a wide range of percentiles wearing chemical or biological protective gear.
		PYRO-25	Gun loading and servicing should be possible concurrently with all other weapon loading and servicing activities to minimize the elapsed downtime.
		PYRO-29	Provide quick mechanical over-travel (no power) for weapon bay doors to maximize the weapon/store loading envelope.
		PYRO-30	Ensure weapon bay door arc (both normal and over-travel) does not block or intrude into adjacent service points or envelopes.
		PYRO-36	Suspension system design and spacing should enable any combination of eight weapons to be loaded by two two-man crews within the refueling time of the vehicle (excludes nuclear weapons).
		PYRO-40	All weapon and store loading functions should be within the percentile range of 5% female to 95% male standing at ground level.
		SAFE-01	Drag chute installation designs not containing electrical safing should contain remote safe/arm provisions reachable from ground level by 5 percentile females. Remove location should be clear of engine exhaust areas and flight control deflection envelopes.
		SAFE-02	Emergency ingress actuation provisions into cockpits, crew stations, passenger compartments, and operator stations should be accessible from the ground by 5 percentile females.
		SAFE-03	Stored energy devices (e.g., accumulators, nitrogen bottles, gas generators, etc.), that could cause injury, harm, or damage if inadvertently actuated, should contain integral safing provisions.
		SAFE-05	Crash locator beacon door opening/ejection mechanisms should contain integral electrical safe/arm features.
		SAFE-06	Wing fold locking mechanisms should provide a moldline indication that locks are in place. Loose or separate safety devices that must be installed manually should be avoided.
		SAFE-07	Landing and alighting gear design should ensure downlocks are integral to the mechanisms and provide a clear indication of position status. This guideline also applies to tail hooks.
		SAFE-08	A single lever safety should, when positioned, safe the entire escape/ejection system. Use of the single lever to "arm" should require two hands.
		SAFE-09	Safing the canopy jettison system should be accomplished through the same lever device used to safe the ejection seat.
		SAFE-10	The single lever safing concept should apply to day-to-day flight operations. Individual or multiple safety pins for pyrotechnic devices should only be required during escape system maintenance.
		SAFE-11	All individual safety pins used for ground maintenance should be clearly visible and coupled together to ensure no single pin will be overlooked during arming.
		SAFE-12	Internal weapon bay doors should contain integral safety locking features for use during maintenance and weapon loading and downloading.
		SAFE-13	It should not be possible to unsafe a weapon bay door integral lock when a door closed signal is present.

Guidelines by Category (Cont'd)

Category No.	Category Title	Guideline No.	Guideline
2.03	Human Factors (including Anthropometric Considerations)	SE-01	<p>Wheel chocks for all types of ground and airborne vehicles should contain the following features:</p> <ul style="list-style-type: none"> - Be nestable for low volume during storage or transport - Be manufactured from corrosion-resistant materials - Be releasable from tire pinch - Be highly visible for day and night operations - Be impervious to all types of fluids used to service or maintain the vehicles - Be of light weight
		SE-02	<p>Wheel chocks for airborne vehicles should also contain the following features:</p> <ul style="list-style-type: none"> - Contain provisions for securing to ramp or flight decks - Contain provisions to secure chocks at wheels - Releasable/removable from outside of hot brake envelope - Contain provisions to enable chock to be used as a tire blowout device - Contain provisions to prevent skidding on snow or ice
		SE-03	<p>Wheel chock design guideline discussion. Wheel chocks have historically contributed to numerous accidents and incidents across the entire design spectrum, yet have received the least design attention of any ground handling/support equipment. Directly and indirectly, poorly designed chocks have:</p> <ul style="list-style-type: none"> - Resulted in numerous "jumping the chocks" incidents due to improper use or positioning, and improper chock sizing for the tire size/power application. Some instances result in destruction of the aircraft. - Resulted in vehicle movement/sliding across wet, snowy and icy surfaces as a result of improper grip. - Resulted in unwarranted tire damage and/or engine FOD. - Resulted in tertiary damage to other vehicles or ground equipment as a result of being blown about by jet/propeller blast. - Damaged surfaces due to temporary placement of chocks on vehicle surfaces during vehicle movement. - Resulted in personnel sliver/s abrasions (wooden chocks) and cuts (metal chocks) even when chocks were in decent useable condition. - Resulted in varied personnel ground accidents during attempts to use chocks as a temporary work stand. - Lost aircraft "over the side" on carriers. <p>Gun port covers or plugs should be lightweight, 100% effective, and easy to install or store. Design personnel seats and padding materials, including the covers and fillers, so they are incapable of creating or emitting toxic fumes or dense smoke when subjected to fire.</p> <p>Design pneumatic floats with an integral air gage located adjacent to the air fill fitting.</p> <p>Use non-skid finishes on the upper surfaces of skids and floats for use as steps and walkways.</p> <p>Design floats with simple drain provisions for each compartment.</p> <p>Design containers used for dinghy stowage to be structurally capable of containing the dinghy within the event of unintentional or uncommanded inflation.</p> <p>Provide crew stations, crew compartments, and operator areas containing dinghies as emergency equipment with a suitable tool for puncturing or cutting the dinghy in the event of inadvertent inflation. Locate the tool so that access is assured during dinghy inflation.</p> <p>Survival gear containerization or storage should have a minimum twelve-month period between scheduled tests, checks, or replacements.</p> <p>Do not seal battery power or battery-operated devices in survival packages or containers. When this guideline cannot be followed, provide a remote way of ascertaining the status or condition of the battery.</p> <p>Design survival equipment pods intended for external carriage or suspension to meet the same environmental and operational criteria as the host vehicle structure.</p> <p>Gap seals should not hinder pilot or ground crew preflight inspection.</p> <p>Gap seals should not degrade loading while wearing arctic or chemical, biological, or radiation protective clothing.</p> <p>Brake-wear indicating pins should be highly visible during day and night operations.</p>
		SE-04	
		SEAT-01	
		SKID-04	
		SKID-06	
		SKID-07	
		SURV-01	
		SURV-02	
		SURV-03	
		SURV-04	
		SURV-05	
		WBAY-15	
		WBAY-16	
		WT&B-02	

Guidelines by Category (Cont'd)

Category No.	Category Title	Guideline No.	Guideline
2.03	Human Factors (including Anthropometric Considerations)	WT&B-03	Provide a parking brake capability to simplify wheel and tire replacements and to reduce operator fatigue during prolonged engine ground operations.
		WT&B-10	No hubcaps or covers should be installed in a manner that prevents full visual viewing of the wheel retaining nut. In instances where this may not be possible, the design should ensure that the hubcap/cover cannot be installed unless the retaining nut is properly installed.
		WT&B-13	Emergency brake handles should not be similar in shape or color as other handles nor should they be located in close proximity to such other handles.
		A-02	Equipment bay and compartment structure should be bonded, co-cured, welded, machined, or combinations thereof to eliminate or minimize the use of mechanical fasteners.
		A-03	All equipment bay and compartment structural flanges and stiffeners should be external to the compartment to maximize the volume available for equipment installation and arrangement.
		A-08	Plumbing penetrations into a compartment should not be on a vertical axis due to difficulty in making or breaking vertically-oriented connections. When compartment access is from the bottom, vertically-oriented connections can allow fluid to leak onto the maintainer. When access is from the top, such connections can allow foreign matter to enter the line. Use horizontal penetrations whenever possible.
		A-11	Locate compartment electrical penetrations close to the access opening for ease of sight, probing, repair, and to eliminate fluid soaking, wicking, or contamination.
		A-12	Locate compartment electrical penetrations far enough from the access opening to prevent damage resulting from improper (over-length) panel fasteners.
		A-13	Two-sided or two-surfaced access should not be required for access to equipment interfaces and hardpoints. The term two-sided infers top/bottom, left/right, front/back, or combinations thereof.
		BIT-06	Mission critical functions should be monitored by BIT.
BIT-09	Use concurrent BIT to monitor system critical functions.		
BIT-16	Critical voltages should be visually monitored by sending the voltage signals to visible LEDs.		
BIT-17	BIT failures should be latched on the module. This makes it easier for the system or ATE to poll the error bit at any time.		
BIT-18	If many BIT routines exist on a module, then ATE should have access and the ability to control each routine individually.		
BIT-19	Design BIT to have a very low false alarm rate; otherwise BIT will not be an effective maintenance tool. As a goal, the false alarm rate should be 1% or less.		
BIT-20	The BIT should be mechanized so that when a piece of equipment is not installed in a subsystem or the product, a failure will not be indicated.		
BIT-26	Locate routinely used test points so they are accessible without removing or disassembling other equipment		
CC-01	Use fiber-optic technologies in preference to conventional interconnect concepts to reduce the number of interconnects/interfaces, reduce manufacturing and ownership costs, and significantly improve R&M.		
CC-02	Standardize connector and wire types to improve testability and logistic support. Keep the number of "different" standard connectors to a minimum. Use the same connector type keyed differently where possible.		
CC-03	Provide clearance around connectors for engagement/disengagement of cables and proper connector orientation under anticipated environmental conditions (e.g., bare hand of 50 percentile male in an enclosed or protected environment and a gloved hand of a 50 percentile male in an open or unprotected environment).		
CC-04	Use quick release cables and locate cables to make removal and replacement easy and to avoid having to remove one cable to gain access to another. Provide adequate space for cables, including sleeving and tie-downs, and adequate service loops for ease of assembly/disassembly		
CC-05	Orient and space connectors to allow a sufficient grip on the connector for cable or wire extraction without fear of using the wiring or cable for additional leverage.		
CC-06	Label, and where possible color code, each wire in a harness or cable to facilitate tracking from origin to termination. Each wire, cable, and coax-to-connector interface should be provided with a source of identification to aid in trouble shooting, repair, or modification. Marking the cable designator on the cable along with bar codes is also recommended.		

Guidelines by Category (Cont'd)

Category No.	Category Title	Guideline No.	Guideline
2.04	Mating and Connections		
		CC-07	Do not manufacture or dress connectors containing more than 25 wires or cables as a single integrated harness. Group the wires or cables into runs of no more than 25 wires or cables each. In addition to making trouble shooting and repair easier, this approach help avoid large bend radii, thereby simplifying routing, packaging, and stowage.
		CC-08	Standardize connector pin assignments for power, ground, and other frequently used signals.
		CC-09	Locate LRU/subsystem critical nodes (and or test points) so they are accessible from a connector to prevent the need for internal LRU probing or access.
		CC-10	Avoid hidden cables. Visually inspecting and tracing all assembly cables rather than having hidden cables (such as behind other cables or even LRUs) allows for a quick system and cable integrity check which aids in overall system integrity and debug. This also implies quick access for manipulative actions.
		CC-11	Orient spare wires and cable pigtailed along the outer diameter or periphery of connectors to make access easier.
		CC-12	Build up and assemble straight and angle connector shells or back shells in a manner that ensures that wire or cable strain or wear is not possible.
		CO-01	Design automated systems and programs with provisions to enable "stop test" and "resume" without the need to cycle back or repeat the entire test.
		CO-03	Use a test connector to provide test and maintenance bus access to all system and subsystem faults.
		CO-04	Design systems and subsystems so that ATE can be used to access, read, and control internal components in concert with the test or checkout program.
		CO-05	Avoid the need for costly adapters for signal communications between system, subsystems, line replaceable units (LRUs) or Weapon Replaceable Assemblies (WRAs), and ATE.
		CONT-01	Control rods should use Boyd or impedance type bolts (or equivalent) to eliminate the need for cotter pins or safety wire.
		CONT-02	Do not use metal control cables for vehicles that will operate in salt water or salt air environments.
		CONT-03	Use control rods rather than control cables for non-complex applications and non-complex routing within the vehicle.
		CONT-04	Use control cables rather than control rods for most complex applications.
		CONT-05	Route cables so that 100 percent of a cable will be viewable for inspection.
		CONT-06	Design all pulleys and brackets associated with cable installations so they are accessible by a 75 percentile male hand.
		EC-01	A threaded electrical connector should contain integral locking mechanisms and visual indications that the connector is properly seated and locked.
		EC-02	An electrical connector requiring less than one full turn to connect or disconnect should contain integral locking mechanisms and visual indications that the connector is properly seated and locked.
		EC-03	A push-pull electrical connector (excluding rack-and-panel type) should contain integral locking features and visual indication that the connector is properly seated and locked.
		EC-04	All electrical connectors should be keyed or asymmetrically shaped to ensure proper alignment.
		EC-05	All electrical connectors should contain scoop-proof shells to ensure pin damage will not occur prior to engaging key way.
		EC-06	All electrical connectors should be corrosion resistant to reduce or eliminate the need for scheduled inspections or corrosion prevention measures.
		EC-07	Avoid using electrical connectors requiring any type or form of soldering.
		EC-08	Locate and position electrical connectors such that all pin identification for either half can be easily seen.
		EC-09	Electrical connectors selected for critical applications on ground vehicles should be both accessible and capable of being connected disconnected by a fifty percentile gloved male hand.
		EC-10	Separation between grouped electrical connectors should be sufficient to ensure make or break of any connector by a fifty percentile gloved male hand. Where this is not possible, an alternate method should be used such as the use of stand-offs, long-shelled connectors alternated with standard connectors, 180-degree connectors alternated with 90-degree connectors, or innovative equivalents.
		EC-11	Avoid connectors requiring potting as a method for environmental protection due to lengthy repair time and tendency for potting compound reversion.

Guidelines by Category (Cont'd)

Category No.	Category Title	Guideline No.	Guideline
2.04	Mating and Connections		
		EC-12	Electrical penetrations into a compartment should not be on a vertical axis to ensure foreign matter does not enter connector.
		EC-13	Electrical, electronic, and coaxial interfaces between fixed and moveable surfaces should contain quick disconnects to simplify replacement of the moveable surface or the electronic module.
		EC-14	Scoop proof connectors should be used throughout unless their use would require an increase in the volume of the aircraft, in which case deviations will be considered on an individual basis.
		EC-15	The removal or replacement of electronic equipment should not require the removal of any other piece of equipment or armament.
		EC-16	Select connectors so that contacts on the "live" or "hot" side of the connection are socket type rather than pin type to minimize personnel hazard and to prevent accidental shorting of live circuits.
		EC-17	Whenever possible, use self-locking connector plugs of a type not requiring safety wire.
		EC-18	All electric connectors should be environment resistant.
		EC-19	Connectors containing fiber optic contacts should, whenever possible, be mounted on a vertical surface to prevent particle and fluid contamination.
		EC-20	Use quick disconnect connectors where allowed and identify all pins on each connector.
		EC-21	Locate connectors far enough apart so that they meet specified requirements.
		EC-22	All connectors should be keyed differently with aligning pins that extend beyond the electrical pins. Connector pins and sockets should engage after key position is entered.
		EC-23	Design connectors so that plugs are cold and receptacles are hot.
		EC-24	Use electrical connectors that incorporate alignment key-ways to reduce incidents of damage due to improper engagement.
		EC-25	Use positive locking, quick disconnect electrical connectors to save man-hours, prevent foreign object damage (FOD) and decrease the chance of personal injury.
		EC-26	Avoid using identical electrical connectors in adjacent areas.
		ECS-26	Design and integrate components whose proper operation depends on the direction of flow such that they cannot be incorrectly installed.
		ENG(G)-01	Provide access to all engine mounts for ground vehicles so that hoisting or crawling under the vehicle is not required.
		ENG(G)-02	Use torque-limiting bolts or torque washers as engine mount attaching hardware to eliminate the need for torque wrenches.
		ENG(G)-03	Design hard points for hoisting or positioning the engine during installation and removal to be integral to the engine and capable of hoisting and supporting a fully-built-up engine package.
		ENG(G)-04	Do not use downward engine removal concepts that require jacking or hoisting of the ground vehicle.
		ENG(G)-05	Use concepts for removing ground vehicle engines from the front, rear, or side rather than from overhead (using hoisting).
		ENG(G)-10	Design attaching hardware for all mechanical engine-to-vehicle interfaces to be captive and with integral safeties.
		ENG(G)-11	Use "torq-set" type clamps or equivalent in all cooling system hose interfaces to eliminate torque wrenches and the potential for error.
		ENG(G)-12	Provide a clear and viewable access envelope to fuel and oil filters.
		ENG(G)-13	Locate fuel filters to ensure no safety hazard will exist due to residual fuel during filter change.
		ENG(G)-14	Access envelopes to fuel and oil filters should not be in close proximity to exhaust manifolds or cooling system return lines.
		ENG(G)-16	Do not locate batteries in the engine compartment. In those instances where this is not possible: - The battery support structure should be of a material that is impervious to acid leakage or boil-over. - The battery support structure should serve as a scupper to collect and direct the acid out of the engine compartment.
		ENG(G)-17	Install simple, lightweight shields over cooling system return lines to protect personnel from hose or line blowout during maintenance.

Guidelines by Category (Cont'd)

Category No.	Category Title	Guideline No.	Guideline
2.04	Mating and Connections	ENG(G)-20 ENG-05	Design all firewall fittings, connectors, and penetrations to be fully viewable and directly accessible to the maintainers. All engine-mounted air and fluid lines should be located next to the fan case, engine case, or full-length fan duct to ensure quick and simple replacement of accessories and components.
		ENG-07	Plumbing and wiring spanning two or more engine modules should contain in-line disconnects to enhance and simplify engine modularization.
		ENG-08	Use V-band clamps to mount accessories to engine-mounted gear boxes.
		ENG-09	On multi-engine air vehicles, the engines should be capable of being installed in any engine cavity without need for reconfiguration.
		ENG-10	On multi-engine air vehicles, the airframe-to-engine interfaces should be in identical positions or orientations for each engine cavity.
		ENG-11	Control-by-wire or control-by-light throttling concepts should take precedence over mechanical controls.
		ENG-12	All engine-mounted accessories must be capable of being removed and installed through the available airframe access openings.
		ENG-25	All engine-to-airframe plumbing, wiring, and duct interfaces should be capable of being connected or disconnected by hand, should contain integral safety provisions, and should not require torquing.
		ENG-31	No rigging or calibration should be required subsequent to replacement of any engine-mounted component.
		ENG-36	All borescope mechanisms should have positive integral locking features.
		ENG-37	Gravity type servicing fittings, covers, and caps should have integral locking features, openable by hand, and contain a cable or chain to prevent loss or dropping.
		ENG-38	The characteristics of engine-to-vehicle interfaces coupled with the capabilities of electronic engine controls, should negate the necessity for making any type of engine rigging including maximum power, idle, and idle cut-off.
		ENG-39	Engine-to-vehicle plumbing quick disconnects should contain positive visual indication that the interface is fully seated and locked.
		ENG-41	Use captive fasteners containing self-locking features to attach the nose dome to the engine face. The fasteners should be fully viewable during engine face FOD inspections.
		ENG-42	Attach engine-to-inlet duct interface seals to the vehicle so they can be left in place during engine removal.
		ENG-43	Design engine-to-inlet duct seal so the interface is automatic during engine installation without needing any form of alignment, adjustment, or mechanical attachment interface.
		ENG-44	Select engine-to-inlet duct seal material to ensure seal life is sufficient for the life of the vehicle.
		ENG-45	Provide remote servicing points accessible from the ground to service engine accessories mounted on top of the engine (e.g., oil tanks, gear boxes, generators, etc.) to eliminate climbing upon or atop the host vehicle.
		ENG-46	Design the basic engine and engine-mounted accessory interface so that no fluid traps or bathtubs exist regardless of engine-mounted accessory location.
		ENG-47	Design the engine, including all accessories, plumbing, wiring, ducts, and mechanisms, to meet the same environmental protection and compatibility requirements as the host vehicle.
		ENG-48	Do not drain or dump residual fuel in the engine fuel control/manifold overboard. When it is not possible to follow this guideline, route the fuel to an engine-mounted collector tank capable of retaining fuel from two shutdowns.
		ENG-49	Design engine fuel and oil filters with integral locking features so they can be installed and removed by hand, and require no torquing.
		ENG-50	Design engine fuel and oil filter delta pressure indicators so they can be reset only from within the filter housing.
		ENG-51	Provide engine fuel and oil filters with anti-surge protection to ensure false delta pressure indications do not occur.
		ENG-53	Design magnetic chip detectors to ensure that oil shut-off will occur as the detector is being removed for visual inspection.
		ENG-54	Incorporate provisions for fuzzi burn-off: in magnetic chip detectors.
		EXT-01	Locate Tanks, Pods, Containers, and Devices (TPCD's) so they do not block or restrict access to existing vehicle access areas or access approach envelopes.

Guidelines by Category (Cont'd)

Category No.	Category Title	Guideline No.	Guideline
2.04	Mating and Connections	EXT-02	Design TPCD's for fuel containment to automatically interface to the host vehicle during installation or removal.
		EXT-03	Design TPCD's to be fully compatible with the existing vehicle built-in hoisting provisions and locking devices.
		HF-09	Develop decals, placards and instruction media around an 8th grade reading level and a 10th grade level of comprehension.
	HOOK-01	Locate, orient, and mechanize Nose Gear Tow/Nose Gear Holdback (NGT/NGH) mechanisms so they do not interfere with the hookup and attachment of standard towbars.	
	HOOK-02	Design NGT/NGH mechanisms with integral provisions to visually indicate correct hookup/attachment. The indication must be visible during all day and night carrier operations.	
	HOOK-06	Avoid the need to remove the tail hook to facilitate engine access or removal.	
	HYD-01	For military combat vehicles having two or more hydraulic power systems, provide a minimum 30-inch spacing between ground power and servicing interfaces to ensure: <ul style="list-style-type: none"> - Design flexibility in locating and arranging equipment in high-density vehicles such as fighters and helicopters, - Work area separation to enable concurrent service/maintenance on systems, - Systems vulnerability enhancement. - Reduction in turn-around elapsed time due to concurrent servicing capability. 	
	HYD-06	Mount hydraulic pumps to the gear box flange with v-band clamps containing a torq-set or equivalent fastener.	
	IN(V)-01	Design inlet door actuators and door actuation mechanisms so they not protrude into the air inlet flow field to eliminate FOD potential.	
	IN(V)-02	Do not use loose structural fasteners in the access area to inlet door actuators and mechanisms. Where this guideline cannot be followed, design the actuator door to be accessible only when the inlet doors are fully closed.	
	IN(V)-08	Incorporate an inlet closure door sealing concept that prevents entry of fluid, dust, or sand across the entire airborne and ground environment spectrum.	
	LG-02	Hardpoints for attachment of landing gear trunnions should be capable of carrying all induced gear loads for the life of the airframe.	
	LG-03	Hardpoints for attachment for landing gear trunnions should not be machined as an integral part of the airframe structure when normal design sink rates over 25 feet per second are required.	
	LG-04	Do not use Beryllium and Beryllium base alloys in any location subject to wear or corrosive atmospheres or in installations where machining may be required.	
	LG-05	All bolts or similar threaded means used as adjustable stops should be positively retained in the adjusted reference without reliance on jam nuts, cotter pins, or safety wire.	
LG-06	Design struts, attachments, and interfaces so they do not depend on scheduled visual inspections, non-destructive inspection (NDI), or non-destructive test (NDT) to ensure the reliability or integrity of the system in the operational environment.		
LG-07	No portion of the landing gear struts, drag braces, or interfaces should contain pockets or bathubs that can trap or hold moisture. In rare instances where this is not possible, holes should be drilled as appropriate to prevent moisture/liquid accumulation.		
LG-08	Brackets, levers, links, rods, et al mounted on the struts should either be symmetrical to tolerate reverse installation or should be impossible to reverse.		
LG-09	Use coiled tubing in lieu of flex lines or hoses for hydraulic line routing from the airframe to the strut.		
LG-10	All wiring or coax mounted to a strut should have appropriate interface connectors to simplify strut removal and installation.		
LG-11	All microswitches, proximity switches, lights, sensors, etc. mounted to a strut should have individual interface connectors. Wiring pigtailed requiring in-line splices should be avoided.		
LG-14	All interfaces from the airframe to the struts should be visible and accessible, and not require removal of airframe structure for access.		
LG-15	No portion of the landing gear closure door(s) should be attached to the strut. In rare instances where this may not be possible, that attached portion should not require alignment or rigging.		

Guidelines by Category (Cont'd)

Category No.	Category Title	Guideline No.	Guideline
2.04	Mating and Connections		
		MC-01	All clamps should contain torque-set or torque-limiting connections to prevent clamp or component failure due to over-torque. Clamp installation call outs should not depend on special tools to establish the required torque values.
		MC-02	Avoid the use of cotter pins, safety wire, safety clips, and similar devices to prevent maintenance-induced events leading to ground vehicle accidents or loss of air vehicles.
		MC-03	All tubing connections and interfaces should use rosan/dynatube (or equivalent) to (1) enable connect or disconnect with one hand, one tool, (2) eliminate the need to safety the connection, (3) provide a superior seal, and (4) negate need to reposition line(s) during component replacement.
		MC-04	No trombone type, flared tube type, or piloted line type interfaces should be used to avoid the need for removal or repositioning during equipment removal.
		MC-06	Locate, position, orient all plumbing and duct electrical connectors to prevent the need for sequential installation or removal.
		MC-07	Maximize areas of constant web thickness in firewalls, carry-through bulkheads, major frames, structural ribs, spars, webs, keels, and close-outs to provide flexibility in locating penetration fittings. Stepped chem milling, stepped machining, stepped composite layup concepts all tend to result in minimal available surface area for penetrations.
		MC-08	All in-line plumbing connections within a fuel tank or cell should be capable of making/breaking the interface by hand, require no torque, contain integral safety locking mechanisms, and should be void of any requirement for safety wire.
		MC-09	All plumbing connections and fittings used for fuel systems should contain integral bonding features to eliminate the need for bonding clamps or jumper cables.
		MC-10	In rare instances where a plumbing run contains complex form or geometry that would require removal of other plumbing or equipment for access, in-line connectors should be incorporated to maintain the integrity of other plumbing or equipment.
		MC-11	No subsystem plumbing, equipment, or wiring should use a tank, cell, or compartment containing liquids as a means for routing or penetration simplicity during manufacture.
		MC-12	All plumbing and connectors containing liquids should be meniscus-free.
		MC-13	In instances where plumbing or connector interfaces cannot or are not keyed for a specific orientation, all identification, markings, cautions, and directions should be placed 360 degrees around the tube or duct.
		MC-14	Where multiple connectors are located in close proximity, ensure (1) a minimum hand tool arc of 120 degrees can be maintained, and (2) stagger fittings to ensure firm coupling interface/hand tool interface can be accomplished without inducing damage to adjacent lines.
		MP-01	Avoid the use epoxies to mount parts on repairable modules because they make repair extremely difficult.
		MP-02	Use a unique identification (ID) resistor incorporated in each system module to verify that the proper module is mounted on ATE.
		MP-03	Design modules so that lengthy warm-up times, special coding and air purity levels, and similar constraints are not necessary.
		OXY-08	LOX containers should contain rear mounted, automatic interfaces.
		P-01	Access door and panel fastener types for airborne vehicles should meet the following criteria: - use latches for a frequency of access of 0 to 40 flight hours - use High Strength Quick Release fasteners for a frequency of access of 40-400 flight hours - use structural screws for a frequency of access of 400 flight hours or more
		P-02	Access door and panel fastener types for surface vehicles should meet the following criteria: - use a spring loaded or latch fastener for an opening frequency of daily - use a one quarter turn fastener (or equivalent) for a opening frequency of weekly - use screws or bolts for all other cases
		PERS-01	Group man-machine interfaces manifold-style to enable connect/disconnect in a single action.
		PERS-02	Include an integral, highly visible indicator in a man-machine interface connector to denote connector is seated and locked.

Guidelines by Category (Cont'd)

Category No.	Category Title	Guideline No.	Guideline
2.04	Mating and Connections		
		PERS-03	Design interface connectors so that a distinct action is required by an individual to effect a disconnect. (Excludes airframe-to-ejection seat personnel interfaces.)
		PERS-04	Interfaces should contain an emergency release mechanism that can be activated by rescue personnel with a 95 percentile gloved hand.
		PERS-05	Design emergency interface release mechanisms to be clearly visible under all types of lighting situations.
		PERS-08	Design stowage and mounting provisions for portable air or oxygen containers to withstand 40G crash or impact loads.
		PYRO-24	Ammo loader interface should not be less than 30" nor more than 50" above the ground to ensure loading can be accomplished by a wide range of percentiles wearing chemical or biological protective gear.
		PYRO-25	Gun loading and servicing should be possible concurrently with all other weapon loading and servicing activities to minimize the elapsed downtime.
		PYRO-26	Do not locate ammunition loader interfaces close to inlets, exhausts, fuel dumps and drains, antennas, sensors, lights, or hazardous protrusions.
		PYRO-27	Incorporate integral hoisting provisions at each weapon/store station to enable direct lift from the container or carrier to the attachment hardpoints.
		PYRO-45	Missile ejectors should be provided with repeatable missile motor fire wires to simplify loading and reduce elapsed time.
		SABCH-15	Give preference to butt type splices over lap type splices in the design of manufacturing splices.
		SEAT-04	Design ejection seats so they can be replaced with canopy or escape hatch installed.
		TP-01	Locate Input/Output (I/O) test points and associated readouts in close proximity to each other so that one person can perform testing.
		TP-02	Protect test points against the environment and from induced contamination.
		WBAY-02	Pylon-to-wing electrical or plumbing interfaces should have automatic close-out covers when pylon is jettisoned or not installed.
		WBAY-03	The method and position of the pylon-to-wing gap scale should not form a drip edge for leakage into the pylon cavity.
		WBAY-04	The gap treatment should be a permanent installation on the pylon, wing, or both, not a separate seal.
		WBAY-05	Gap treatment should not interfere with or be damaged by existing pylon handling support equipment.
		WBAY-06	Pylon rigging should not be required for gap seal control.
		WBAY-07	Gap seal should not degrade interchangeability of pylon.
		WBAY-08	Gap seal and treatment should be fully compatible with steam from carrier catapults.
		WBAY-09	Gap seal/pylon should not cover or hamper access to low point wing drains.
		WBAY-10	No loose hardware should exist before or after pylon is installed.
		WBAY-11	Gap seal should match pylon and wing/fuselage surface impedance.
		WBAY-12	Pylon-to-store/weapon gap seal should permit visual and physical access during loading for all interfaces between bomb rack-to-store, bomb rack-to-launcher, and launcher-to-store.
		WBAY-13	Pylon-to-store/weapon gap seal should not interfere with automatic sway brace function.
		WBAY-14	Pylon-to-store/weapon gap seal should permit physical access to lanyards.
		WBAY-15	Gap seals should not hinder pilot or ground crew preflight inspection.
		WBAY-16	Gap seals should not degrade loading while wearing arctic or chemical, biological, or radiation protective clothing.
		WBAY-17	Special coatings or conductive paints on pylons, launchers, racks, launchers, tanks, pods, etc. should have the durability to withstand contact with support stands/cradles during storage.
		WT&B-09	Brake clips, end plates, retainers, etc. used to build up wheel, tire, and brake assemblies should not be capable of reverse or improper installation.
2.05	Standardization and Interchangeability	A-14	Do not locate nutplates or gang channels in inaccessible areas that would require extensive disassembly or equipment removal to gain access.
		A-15	Locate tie-down attachment points such that tie-down chains, straps, or cables do not prevent or restrict normal servicing, weapon loading, or safe/arm functions.

Guidelines by Category (Cont'd)

Category No.	Category Title	Guideline No.	Guideline
2.05	Standardization and Interchangeability	A-16	Structural design should provide good access to corrosion-prone areas for inspection and treatment.
		A-17	All structural fasteners in an access door or panel should be of identical grip and diameter. In rare cases where this is not possible, fasteners of different grip must have different diameters to prevent a shorter fastener being substituted for the correct, longer fastener.
		A-18	Use transparent windows, quick-opening covers, or openings without any cover to permit quick visual inspections where needed.
		BIT-01	During design of the BIT, use worst-case stress analysis to ensure that any circuit failures induced by temperature extremes, tolerance build-up, power supply variations, and combinations thereof are identified.
		BIT-02	Ensure that BIT system thresholds are consistent with those across the system, subsystem, item, module, and piece-part levels to prevent excessive numbers of Cannot Duplicate (CND) and Retest OK (RTOK) events from occurring.
		BIT-03	The degree of BIT required or proposed should be based on the respective failure rates and the appropriate FMECA at all equipment indenture levels.
		BIT-05	Incorporate testability design features as an integral part of equipment preliminary design process.
		BIT-06	Mission critical functions should be monitored by BIT.
		BIT-09	Use concurrent BIT to monitor system critical functions.
		BIT-11	In the area of software design and test responsibility, the responsibility for the design and development of verification testing of an end item (e.g., digital filter) should reside with the same engineer(s).
		BIT-12	Define stimuli and response data for each diagnostic test at the system/subsystem level. The same data should be planned for use both in factory testing as well as in field maintenance of the equipment. These data minimize the amount of unique software to be written.
		BIT-13	Provide for manual control to test sequences, so that the test can be selected individually, and appropriate test combinations can be executed at the operator's discretion.
		BIT-14	Provide access to all BIT control and status signals at module connector pins. This will enable ATE to directly connect to BIT circuitry.
		BIT-15	Incorporate complete BIT functions and BITE on module. If only a portion of the BIT routine or BITE circuitry exists on the module, then ATE cannot utilize the BIT routine without providing the missing BIT functions.
		BIT-16	Critical voltages should be visually monitored by sending the voltage signals to visible LEDs.
		BIT-17	BIT failures should be latched on the module. This makes it easier for the system or ATE to poll the error bit at any time.
		BIT-18	If many BIT routines exist on a module, then ATE should have access and the ability to control each routine individually.
		BIT-19	Design BIT to have a very low false alarm rate; otherwise BIT will not be an effective maintenance tool. As a goal, the false alarm rate should be 1% or less.
		BIT-20	The BIT should be mechanized so that when a piece of equipment is not installed in a subsystem or the product, a failure will not be indicated.
		BIT-21	The failure detection function should provide the equipment operator with a go/no-go indication of equipment readiness.
		BIT-22	The BIT should be designed so that auxiliary test devices or external equipment are not needed for daily and other regular checks.
		BIT-23	Design BIT so it is initiated automatically upon equipment power-up.
		BIT-24	Test points should be functionally grouped together and clearly labeled for convenience and ease of maintenance.
		BIT-25	Equipment should not require manual probing to fault isolate.
		BIT-26	Locate routinely used test points so they are accessible without removing or disassembling other equipment
		BIT-27	Periodic and initiated BIT should detect at least 98% of all failures and isolate a minimum 99% of those failures detected to a single LRU or WRA.
		BIT-28	Design BIT to have the same level of EMI protection as the system or equipment being monitored.
		CC-01	Use fiber-optic technologies in preference to conventional interconnect concepts to reduce the number of interconnects/interfaces, reduce manufacturing and ownership costs, and significantly improve R&M.

Guidelines by Category (Cont'd)

Category No.	Category Title	Guideline No.	Guideline
2.05	Standardization and Interchangeability	CC-02	Standardize connector and wire types to improve testability and logistic support. Keep the number of "different" standard connectors to a minimum. Use the same connector type keyed differently where possible.
		CC-03	Provide clearance around connectors for engagement/disengagement of cables and proper connector orientation under anticipated environmental conditions (e.g., bare hand of 50 percentile male in an enclosed or protected environment and a gloved hand of a 50 percentile male in an open or unprotected environment).
		CC-04	Use quick release cables and locate cables to make removal and replacement easy and to avoid having to remove one cable to gain access to another. Provide adequate space for cables, including sleeving and tie-downs, and adequate service loops for ease of assembly/disassembly.
		CC-05	Orient and space connectors to allow a sufficient grip on the connector for cable or wire extraction without fear of using the wiring or cable for additional leverage.
		CC-06	Label, and where possible color code, each wire in a harness or cable to facilitate tracking from origin to termination. Each wire, cable, and coax-to-connector interface should be provided with a source of identification to aid in trouble shooting, repair, or modification. Marking the cable designator on the cable along with bar codes is also recommended.
		CC-07	Do not manufacture or dress connectors containing more than 25 wires or cables each. In addition to making trouble shooting and repair the wires or cables into runs of no more than 25 wires or cables each. In addition to making trouble shooting and repair easier, this approach help avoid large bend radii, thereby simplifying routing, packaging, and stowage.
		CC-08	Standardize connector pin assignments for power, ground, and other frequently used signals.
		CC-09	Locate LRU/subsystem critical nodes (and or test points) so they are accessible from a connector to prevent the need for internal LRU probing or access.
		CC-10	Avoid hidden cables. Visually inspecting and tracing all assembly cables rather than having hidden cables (such as behind other cables or even LRUs) allows for a quick system and cable integrity check which aids in overall system integrity and debug. This also implies quick access for manipulative actions.
		CC-11	Orient spare wires and cable pigtails along the outer diameter or periphery of connectors to make access easier.
		CC-12	Build up and assemble straight and angle connector shells or back shells in a manner that ensures that wire or cable strain or wear is not possible.
		CO-01	Design automated systems and programs with provisions to enable "stop test" and "resume" without the need to cycle back or repeat the entire test.
		CO-02	In the event of program loss or hang-up, automated systems and programs should have provisions for reverting to manual test and operation.
		CO-03	Use a test connector to provide test and maintenance bus access to all system and subsystem faults.
		CO-04	Design systems and subsystems so that ATE can be used to access, read, and control internal components in concert with the test or checkout program.
		CO-05	Avoid the need for costly adapters for signal communications between system, subsystems, line replaceable units (LRUs) or Weapon Replaceable Assemblies (WRAs), and ATE.
		CONT-01	Control rods should use Boyd or impedance type bolts (or equivalent) to eliminate the need for cotter pins or safety wire.
		CONT-02	Do not use metal control cables for vehicles that will operate in salt water or salt air environments.
		CONT-03	Use control rods rather than control cables for non-complex applications and non-complex routing within the vehicle.
		CONT-04	Use control cables rather than control rods for most complex applications.
		CONT-05	Route cables so that 100 percent of a cable will be viewable for inspection.
		CONT-06	Design all pulleys and brackets associated with cable installations so they are accessible by a 75 percentile male hand.
		CREW-03	In rare cases where armor is parasitic, armor should be interchangeable and easily installed.
		CREW-05	Structural instrument panels, dashboards, and control panels should be modularized for easy and adequate access to all interfaces, to simplify manufacturing, and to reduce maintenance-induced problems.
		EC-01	A threaded electrical connector should contain integral locking mechanisms and visual indications that the connector is properly seated and locked.
		EC-02	An electrical connector requiring less than one full turn to connect or disconnect should contain integral locking mechanisms and visual indications that the connector is properly seated and locked.

Guidelines by Category (Cont'd)

Category No.	Category Title	Guideline No.	Guideline
2.05	Standardization and Interchangeability	EC-03	A push-pull electrical connector (excluding rack-and-panel type) should contain integral locking features and visual indication that the connector is properly seated and locked.
		EC-04	All electrical connectors should be keyed or asymmetrically shaped to ensure proper alignment.
		EC-05	All electrical connectors should contain scoop-proof shells to ensure pin damage will not occur prior to engaging key way.
		EC-06	All electrical connectors should be corrosion resistant to reduce or eliminate the need for scheduled inspections or corrosion prevention measures.
		EC-07	Avoid using electrical connectors requiring any type or form of soldering.
		EC-08	Locate and position electrical connectors such that all pin identification for either half can be easily seen.
		EC-09	Electrical connectors selected for critical applications on ground vehicles should be both accessible and capable of being connected disconnected by a fifty percentile gloved male hand.
		EC-10	Separation between grouped electrical connectors should be sufficient to ensure make or break of any connector by a fifty percentile gloved male hand. Where this is not possible, an alternate method should be used such as the use of stand-offs, long-shelled connectors, alternated with standard connectors, 180-degree connectors alternated with 90-degree connectors, or innovative equivalents.
		EC-11	Avoid connectors requiring potting as a method for environmental protection due to lengthy repair time and tendency for potting compound reversion.
		EC-16	Select connectors so that contacts on the "live" or "hot" side of the connection are socket type rather than pin type to minimize personnel hazard and to prevent accidental shorting of live circuits.
		EC-17	Whenever possible, use self-locking connector plugs of a type not requiring safety wire.
		EC-18	All electric connectors should be environment resistant.
		EC-19	Connectors containing fiber optic contacts should, whenever possible, be mounted on a vertical surface to prevent particle and fluid contamination.
		EC-20	Use quick disconnect connectors where allowed and identify all pins on each connector.
		EC-21	Locate connectors far enough apart so that they meet specified requirements.
		EC-22	All connectors should be keyed differently with aligning pins that extend beyond the electrical pins. Connector pins and sockets should engage after key position is entered.
		EC-23	Design connectors so that plugs are cold and receptacles are hot.
		EC-24	Use electrical connectors that incorporate alignment key-ways to reduce incidents of damage due to improper engagement.
		EC-25	Use positive locking, quick disconnect electrical connectors to save man-hours, prevent foreign object damage (FOD) and decrease the chance of personal injury.
		EC-26	Avoid using identical electrical connectors in adjacent areas.
		EG-01	Design feedback loops so that the loop can be broken during test to ensure that faults do not propagate to the point where they cannot be isolated.
		EG-02	Avoid using external feedback loops requiring complex circuitry to simulate feedback I/Os.
		EG-03	In rare instances when complex external feedback loops cannot be avoided, incorporate simple interruptible control points.
		EG-04	Avoid long sequences of vectors to initialize or alter device outputs to minimize potential testability problems.
		EG-05	Avoid the need to have test equipment generate complex, phased or time related signals.
		EG-06	Test points should be located on all circuit nodes that are useful in determining the module's health.
		EG-07	Test points should be designed so that functional circuitry cannot be damaged or degraded due to the routing or accidental shorting of a signal at a test point. Some type of test point isolation technique should be used (buffers, isolator, etc.).
		EG-08	Test points should be easily accessed and clearly marked.
		EG-10	Design redundant circuits to be independently testable to ensure errors are not masked.

Guidelines by Category (Cont'd)

Category No.	Category Title	Guideline No.	Guideline
2.05	Standardization and Interchangeability		
		EG-11	To improve the probability of fault detection, avoid shorting signals together to achieve a specific test function or condition.
		EG-12	Incorporate concept for partitioning module functions to simplify test equipment or eliminate the need for ancillary test equipment.
		EG-13	Design oscillators or clocks that are resident on the module to be replaceable by a signal from a connector to avoid the need to synchronize ATE to on-board signals.
		ENG(G)-02	Use torque-limiting bolts or torque washers as engine mount attaching hardware to eliminate the need for torque wrenches.
		ENG(G)-19	Paint engine compartments gloss white to enhance light reflectivity and enhance fluid leak detection.
		ENG(G)-20	Design all firewall fittings, connectors, and penetrations to be fully viewable and directly accessible to the maintainers.
		ENG-05	All engine-mounted air and fluid lines should be located next to the fan case, engine case, or full-length fan duct to ensure quick and simple replacement of accessories and components.
		ENG-09	On multi-engine air vehicles, the engines should be capable of being installed in any engine cavity without need for reconfiguration.
		ENG-10	On multi-engine air vehicles, the airframe-to-engine interfaces should be in identical positions or orientations for each engine cavity.
		ENG-23	All engine borescope provisions should be accessible with the engine installed and hooked up.
		ENG-24	Replacement of all ignitors should be possible with the engine installed.
		ENG-25	All engine-to-airframe plumbing, wiring, and duct interfaces should be capable of being connected or disconnected by hand, should contain integral safety provisions, and should not require torquing.
		ENG-36	All borescope mechanisms should have positive integral locking features.
		ENG-37	Gravity type servicing fittings, covers, and caps should have integral locking features, openable by hand, and contain a cable or chain to prevent loss or dropping.
		ENG-40	Design of electronic engine controls should be such that no single failure of a sub-component within can result in over speed, over temperature, stagnation, or shut-down.
		F-01	Use blind fasteners only where absolutely necessary or where considerable cost can be saved.
		F-02	Minimize access fasteners while making them quick release, easily removed and replaced, and captive.
		F-03	Choose fasteners based on the requirement to operate by hand or with common hand tools rather than special tools.
		F-04	Whenever possible, incorporate barrel type fasteners as opposed to hi-torque fasteners. Failure of Hi-torque fasteners due to stripping are common and a source of potential foreign object damage (FOD).
		FI-01	Design each FI test to be independent of all other tests.
		FI-02	Design FI initiation to be subordinate to the higher priority predecessor tests.
		FI-03	Design each test so that it can be terminated prior to completion and then re-initiated at its start point.
		FI-04	Design the unit tests so that they can accommodate the following subsystem response modes: <ul style="list-style-type: none"> - Incorrect response - No response - Inconsistent response - Unexpected condition
		FI-05	Design all software so that it is structured by test priority. The test software should take advantage of both subroutine constructs for all message outputs and of failure dictionaries which identify the location of the most likely failed replaceable unit.
		FI-06	In an airborne avionics system, consider indicating mission critical faults on a pilots "head-up" display accompanied with an audible alarm, so that the pilot can easily check for critical system or mission threatening problems.
		FI-07	Ensure that system user manuals include instructions for faults not covered by BIT such as, system will not power up or system is being used in an incorrect environment such as, at the wrong altitude, etc.
		FI-08	Interlock the high power sections of systems and subsystems with visual/audible BIT to ensure safe system activation.

Guidelines by Category (Cont'd)

Category No.	Category Title	Guideline No.	Guideline
2.05	Standardization and Interchangeability		
		FI-09	Design BIT to first conduct self-test for circuitry integrity before conducting system test.
		FI-10	Use clear text to report failures rather than alpha-numeric codes, lights, indicators, etc.
		FI-11	Locate BIT circuitry on the same level of the subsystem under test to simplify test and repair when it is removed from the main system.
		HOOK-04	Design tail hook points to be interchangeable and easily replaceable.
		IN(V)-04	Design inlet doors and inlet bellmouth fairings to be fully interchangeable to eliminate the need to cut, file, or trim at the engine face.
		IN(V)-05	Locate the inlet duct edge a minimum of 60 inches from the cockpit or crew station to eliminate restricting engine operation to canopy-closed conditions.
		IN-05	Both integral and remote engine front frames should be interchangeable.
		LG-21	Proximity type switches used in landing gear design should meet a minimum of 200 volt-amperes to eliminate Electromagnetic Interference (EMI) or Radiation Hazard (RADHAD) problems. Wiring associated with the landing gear design should meet the same requirements.
		LG-23	Design strut fittings for servicing nitrogen or hydraulic fluid to be easily accessible and adjacent to the appropriate strut pressure gage.
		LG-24	Design struts so they can be serviced with clean, dry air in lieu of nitrogen during deployments without affecting the overall reliability.
		LG-38	All landing gear doors should be interchangeable.
		LG-39	Gear-mounted tie-down or chain-down fittings should be interchangeable and easily replaceable.
		LO-07	Flush and non-flush LO screens should be interchangeable.
		MC-01	All clamps should contain torque-set or torque-limiting connections to prevent clamp or component failure due to over-torque. Clamp installation call outs should not depend on special tools to establish the required torque values.
		MC-02	Avoid the use of cotter pins, safety wire, safety clips, and similar devices to prevent maintenance-induced events leading to ground vehicle accidents or loss of air vehicles.
		MC-03	All tubing connections and interfaces should use rosan/dynatube (or equivalent) to (1) enable connect or disconnect with one hand, one tool, (2) eliminate the need to safety the connection, (3) provide a superior seal, and (4) negate need to reposition line(s) during component replacement.
		MC-04	No trombone type, flared tube type, or piloted line type interfaces should be used to avoid the need for removal or repositioning during equipment removal.
		MC-05	Avoid potential foreign object traps during manufacturing or operational maintenance by eliminating vertical penetrations of plumbing/fittings into tanks, compartments, or cells
		MC-06	Locate, position, orient all plumbing and duct electrical connectors to prevent the need for sequential installation or removal.
		MC-07	Maximize areas of constant web thickness in firewalls, carry-through bulkheads, major frames, structural ribs, spars, webs, keels, and close-outs to provide flexibility in locating penetration fittings. Stepped chem milling, stepped machining, stepped composite layup concepts all tend to result in minimal available surface area for penetrations.
		MC-08	All in-line plumbing connections within a fuel tank or cell should be capable of making/breaking the interface by hand, require no torque, contain integral safety locking mechanisms, and should be void of any requirement for safety wire.
		MC-09	All plumbing connections and fittings used for fuel systems should contain integral bonding features to eliminate the need for bonding clamps or jumper cables.
		MC-10	In rare instances where a plumbing run contains complex form or geometry that would require removal of other plumbing or equipment for access, in-line connectors should be incorporated to maintain the integrity of other plumbing or equipment.
		MC-11	No subsystem plumbing, equipment, or wiring should use a tank, cell, or compartment containing liquids as a means for routing or penetration simplicity during manufacture.
		MC-12	All plumbing and connectors containing liquids should be meniscus-free.

Guidelines by Category (Cont'd)

Category No.	Category Title	Guideline No.	Guideline
2.05	Standardization and Interchangeability	MC-13	In instances where plumbing or connector interfaces cannot or are not keyed for a specific orientation, all identification, markings, cautions, and directions should be placed 360 degrees around the tube or duct.
		MC-14	Where multiple connectors are located in close proximity, ensure (1) a minimum hand tool arc of 120 degrees can be maintained, and (2) stagger fittings to ensure firm coupling interface/hand tool interface can be accomplished without inducing damage to adjacent lines.
		MC-15	Route, orient, and position plumbing, wiring, ducts, and connectors sufficiently away from the outer surface of the vehicle to preclude induced damage due to minor dents, drill bits during repair, etc. Minimum rule of thumb is 1" away from the inner surface and 1" below a plate nut channel.
		MG-01	Mount LRUs/sub-systems on drawer slides or extender racks to provide easier accessibility during integration, testing, debug, and repair of Units Under Test (UUTs).
		MG-02	Use a modular system design so that each subassembly is designed as a functionally complete entity. Then when a subassembly was removed for testing, ATE will not need custom circuitry to simulate missing functions.
		MG-03	Clearly mark all subsystems/LRUs to make system integration, test, debug, and repair easier.
		MP-01	Avoid the use of epoxies to mount parts on repairable modules because they make repair extremely difficult.
		MP-02	Use a unique identification (ID) resistor incorporated in each system module to verify that the proper module is mounted on ATE.
		MP-03	Design modules so that lengthy warm-up times, special coding and air purity levels, and similar constraints are not necessary.
		P-11	Access doors and panels should be interchangeable as justified by operation and support costs or life cycle costs.
		PYRO-39	Weapon bay ejectors and launchers should have the capability for total interchangeability and reconfigurability.
		SABCH-02	All flush type structural screws should have identical head drives for the entire vehicle.
		SABCH-03	All non-flush type structural screws should have identical head drive recesses for the entire vehicle.
		SABCH-04	Special high strength bolts, such as twelve-point heads, should be fully justified from standpoint of the cost of ownership and effectiveness.
		SABCH-05	Structural design should avoid the reliance on blind fasteners unless fully supported by cost, weight, schedule, and effectiveness analysis.
		SE-01	Wheel chocks for all types of ground and airborne vehicles should contain the following features: <ul style="list-style-type: none"> - Be nestable for low volume during storage or transport - Be manufactured from corrosion-resistant materials - Be releasable from tire pinch - Be highly visible for day and night operations - Be impervious to all types of fluids used to service or maintain the vehicles - Be of light weight
		SE-02	Wheel chocks for airborne vehicles should also contain the following features: <ul style="list-style-type: none"> - Contain provisions for securing to ramp or flight decks - Contain provisions to secure chocks at wheels - Releasable/removable from outside of hot brake envelope - Contain provisions to enable chock to be used as a tire blowout device - Contain provisions to prevent skidding on snow or ice

Guidelines by Category (Cont'd)

Category No.	Category Title	Guideline No.	Guideline
2.05	Standardization and Interchangeability	SE-03	<p>Wheel chock design guideline discussion. Wheel chocks have historically contributed to numerous accidents and incidents across the entire design spectrum, yet have received the least design attention of any ground handling/support equipment. Directly and indirectly, poorly designed chocks have:</p> <ul style="list-style-type: none"> - Resulted in numerous "jumping the chocks" incidents due to improper use or positioning, and improper chock sizing for the tire size/power application. Some instances result in destruction of the aircraft. - Resulted in vehicle movement/sliding across wet, snowy and icy surfaces as a result of improper grip. - Resulted in unwarranted tire damage and/or engine FOD. - Resulted in tertiary damage to other vehicles or ground equipment as a result of being blown about by jet/propeller blast. - Damaged surfaces due to temporary placement of chocks on vehicle surfaces during vehicle movement. - Resulted in personnel sliver/s abrasions (wooden chocks) and cuts (metal chocks) even when chocks were in decent useable condition. - Resulted in varied personnel ground accidents during attempts to use chocks as a temporary work stand. - Lost aircraft "over the side" on carriers. <p>Location and design of all exterior lights should not require protective covers in ground environments. Landing and taxi lights should be mounted on landing gear struts or doors to eliminate separate compartments, doors, and retraction/extension mechanisms.</p> <p>Speed brake or speed brake cavity should contain integral mechanical locking mechanism for personnel safety.</p> <p>Design single-shot (one time use) type thrusters with a minimum 6-year shelf life and a 7-year installed life.</p> <p>Locate Input/Output (I/O) test points and associated readouts in close proximity to each other so that one person can perform testing.</p> <p>Protect test points against the environment and from induced contamination.</p> <p>Protect test points from outside signal generation.</p> <p>Equipment bays and compartments should not require installation of special cavity fillers when equipment is not installed. Gap seal should not degrade interchangeability of pylon.</p> <p>Design EO windows and optics to be interchangeable among the same air vehicle types or same ground vehicle types.</p> <p>Equipment bay and compartment structure should be bonded, co-cured, welded, machined, or combinations thereof to eliminate or minimize the use of mechanical fasteners.</p> <p>All equipment bay and compartment structural flanges and stiffeners should be external to the compartment to maximize the volume available for equipment installation and arrangement.</p> <p>Use stiffening beads in lieu of flanges to the maximum extent to enhance compartment volume and simplify repairs.</p> <p>Stiffening beads should have the convex surface toward the compartment to eliminate fluid traps.</p> <p>Keep all machined compartment frames, webs, and closure panels to a constant thickness (e.g., not stepped or tapered) to ease simplicity of fluid or electrical penetrations and ease and simplicity of structural repair.</p> <p>Hardpoints (structural attachment and load bearing areas) within a compartment to assist in equipment mounting or support should not be integral with the machined part. Hardpoints should be parasitic to enable quick repair in case of wear or damage in lieu of precise ream/bush repair typical of machined hardpoints.</p> <p>Paint equipment bay and compartment interiors a high gloss white to maximize lighting reflectivity, visibility, and rapid leak detection capability.</p> <p>Plumbing penetrations into a compartment should not be on a vertical axis due to difficulty in making or breaking vertically-oriented connections. When compartment access is from the bottom, vertically-oriented connections can allow fluid to leak onto the maintainer. When access is from the top, such connections can allow foreign matter to enter the line. Use horizontal penetrations whenever possible.</p> <p>Any heat or temperature sensitive structure within a compartment should contain heat-sensitive tape or appropriate heat sensor for easy indication of over-temperature excursions.</p> <p>Provide a sufficient number of compartment fluid drains to ensure fluid drainage for varying aircraft static attitudes and varying terrain slopes for ground vehicles.</p>
2.06	Simplification	SIMP-01	
		SIMP-02	
		SIMP-03	
		T-05	
		TP-01	
		TP-02	
		TP-03	
		WBAY-01	
		WBAY-07	
		WIND-12	
A-02			
A-03			
A-04			
A-05			
A-06			
A-07			
A-08			
A-09			
A-10			

Guidelines by Category (Cont'd)

Category No.	Category Title	Guideline No.	Guideline
2.06	Simplification	A-11	Locate compartment electrical penetrations close to the access opening for ease of sight, probing, repair, and to eliminate fluid soaking, wicking, or contamination.
		A-12	Locate compartment electrical penetrations far enough from the access opening to prevent damage resulting from improper (over-length) panel fasteners.
		A-13	Two-sided or two-surfaced access should not be required for access to equipment interfaces and hardpoints. The term two-sided infers top/bottom, left/right, front/back, or combinations thereof.
		A-14	Do not locate nutplates or gang channels in inaccessible areas that would require extensive disassembly or equipment removal to gain access.
		A-15	Locate tie-down attachment points such that tie-down chains, straps, or cables do not prevent or restrict normal servicing, weapon loading, or safe/arm functions.
		A-16	Structural design should provide good access to corrosion-prone areas for inspection and treatment.
		A-17	All structural fasteners in an access door or panel should be of identical grip and diameter. In rare cases where this is not possible, fasteners of different grip must have different diameters to prevent a shorter fastener being substituted for the correct, longer fastener.
		A-18	Use transparent windows, quick-opening covers, or openings without any cover to permit quick visual inspections where needed.
		BIT-01	During design of the BIT, use worst-case stress analysis to ensure that any circuit failures induced by temperature extremes, tolerance build-up, power supply variations, and combinations thereof are identified.
		BIT-02	Ensure that BIT system thresholds are consistent with those across the system, subsystem, item, module, and piece-part levels to prevent excessive numbers of Cannot Duplicate (CND) and Retest OK (RTOK) events from occurring.
		BIT-03	The degree of BIT required or proposed should be based on the respective failure rates and the appropriate FMECA at all equipment indenture levels.
		BIT-04	Limit the amount of data that is recorded to a manageable size by: <ul style="list-style-type: none"> - Limiting the number of signals that are monitored - Limiting the maximum sampling rate - Reducing the time span over which data is accumulated - Restricting the type of data accumulated
		BIT-05	Incorporate testability design features as an integral part of equipment preliminary design process.
		BIT-06	Mission critical functions should be monitored by BIT.
		BIT-09	Use concurrent BIT to monitor system critical functions.
		BIT-11	In the area of software design and test responsibility, the responsibility for the design and development of verification testing of an end item (e.g., digital filter) should reside with the same engineer(s).
		BIT-12	Define stimuli and response data for each diagnostic test at the system/subsystem level. The same data should be planned for use both in factory testing as well as in field maintenance of the equipment. These data minimize the amount of unique software to be written.
		BIT-13	Provide for manual control to test sequences, so that the test can be selected individually, and appropriate test combinations can be executed at the operator's discretion.
		BIT-14	Provide access to all BIT control and status signals at module connector pins. This will enable ATE to directly connect to BIT circuitry.
		BIT-15	Incorporate complete BIT functions and BITE on module. If only a portion of the BIT routine or BITE circuitry exists on the module, then ATE cannot utilize the BIT routine without providing the missing BIT functions.
		BIT-16	Critical voltages should be visually monitored by sending the voltage signals to visible LEDs.
		BIT-17	BIT failures should be latched on the module. This makes it easier for the system or ATE to poll the error bit at any time.
		BIT-18	If many BIT routines exist on a module, then ATE should have access and the ability to control each routine individually.
		BIT-19	Design BIT to have a very low false alarm rate; otherwise BIT will not be an effective maintenance tool. As a goal, the false alarm rate should be 1% or less.

Guidelines by Category (Cont'd)

Category No.	Category Title	Guideline No.	Guideline
2.06	Simplification		
		BIT-20	The BIT should be mechanized so that when a piece of equipment is not installed in a subsystem or the product, a failure will not be indicated.
		BIT-21	The failure detection function should provide the equipment operator with a go/no-go indication of equipment readiness.
		BIT-22	The BIT should be designed so that auxiliary test devices or external equipment are not needed for daily and other regular checks.
		BIT-23	Design BIT so it is initiated automatically upon equipment power-up.
		BIT-24	Test points should be functionally grouped together and clearly labeled for convenience and ease of maintenance.
		BIT-25	Equipment should not require manual probing to fault isolate.
		BIT-26	Locate routinely used test points so they are accessible without removing or disassembling other equipment
		BIT-27	Periodic and initiated BIT should detect at least 98% of all failures and isolate a minimum 99% of those failures detected to a single LRU or WRA.
		BIT-28	Design BIT to have the same level of EMI protection as the system or equipment being monitored.
		C-01	Avoid swivel type connectors and fittings for air, fuel, or hydraulic line interfaces due to their history of low reliability.
		C-02	Provide spacing between parallel plumbing runs so that in-line couplings can be replaced without removing lines or disconnecting any line support devices.
		CC-01	Use fiber-optic technologies in preference to conventional interconnect concepts to reduce the number of interconnects/interfaces, reduce manufacturing and ownership costs, and significantly improve R&M.
		CC-02	Standardize connector and wire types to improve testability and logistic support. Keep the number of "different" standard connectors to a minimum. Use the same connector type keyed differently where possible.
		CC-03	Provide clearance around connectors for engagement/disengagement of cables and proper connector orientation under anticipated environmental conditions (e.g., bare hand of 50 percentile male in an enclosed or protected environment and a gloved hand of a 50 percentile male in an open or unprotected environment).
		CC-04	Use quick release cables and locate cables to make removal and replacement easy and to avoid having to remove one cable to gain access to another. Provide adequate space for cables, including sleeving and tie-downs, and adequate service loops for ease of assembly/disassembly
		CC-05	Orient and space connectors to allow a sufficient grip on the connector for cable or wire extraction without fear of using the wiring or cable for additional leverage.
		CC-06	Label, and where possible color code, each wire in a harness or cable to facilitate tracking from origin to termination. Each wire, cable, and coax-to-connector interface should be provided with a source of identification to aid in trouble shooting, repair, or modification. Marking the cable designator on the cable along with bar codes is also recommended.
		CC-07	Do not manufacture or dress connectors containing more than 25 wires or cables as a single integrated harness. Group the wires or cables into runs of no more than 25 wires or cables each. In addition to making trouble shooting and repair easier, this approach help avoid large bend radii, thereby simplifying routing, packaging, and stowage.
		CC-08	Standardize connector pin assignments for power, ground, and other frequently used signals.
		CC-09	Locate LRU/subsystem critical nodes (and or test points) so they are accessible from a connector to prevent the need for internal LRU probing or access.
		CC-10	Avoid hidden cables. Visually inspecting and tracing all assembly cables rather than having hidden cables (such as behind other cables or even LRUs) allows for a quick system and cable integrity check which aids in overall system integrity and debug. This also implies quick access for manipulative actions.
		CO-01	Design automated systems and programs with provisions to enable "stop test" and "resume" without the need to cycle back or repeat the entire test.
		CO-02	In the event of program loss or hang-up, automated systems and programs should have provisions for reverting to manual test and operation.
		CO-03	Use a test connector to provide test and maintenance bus access to all system and subsystem faults.
		CO-04	Design systems and subsystems so that ATE can be used to access, read, and control internal components in concert with the test or checkout program.

Guidelines by Category (Cont'd)

Category No.	Category Title	Guideline No.	Guideline
2.06	Simplification	CO-05	Avoid the need for costly adapters for signal communications between system, subsystems, line replaceable units (LRUs) or Weapon Replaceable Assemblies (WRAs), and ATE.
		CONT-01	Control rods should use Boyd or impedance type bolts (or equivalent) to eliminate the need for cotter pins or safety wire.
		CONT-02	Do not use metal control cables for vehicles that will operate in salt water or salt air environments.
		CONT-03	Use control rods rather than control cables for non-complex applications and non-complex routing within the vehicle.
		CONT-04	Use control cables rather than control rods for most complex applications.
		CONT-05	Route cables so that 100 percent of a cable will be viewable for inspection.
		CONT-06	Design all pulleys and brackets associated with cable installations so they are accessible by a 75 percentile male hand.
		CREW-03	In rare cases where armor is parasitic, armor should be interchangeable and easily installed.
		CREW-10	Design cameras, recorders, and sensors to be fully interchangeable and quickly replaceable.
		CREW-12	Requirements for boresighting should not be part of the design or integration.
		EC-01	A threaded electrical connector should contain integral locking mechanisms and visual indications that the connector is properly seated and locked.
		EC-02	An electrical connector requiring less than one full turn to connect or disconnect should contain integral locking mechanisms and visual indications that the connector is properly seated and locked.
		EC-03	A push-pull electrical connector (excluding rack-and-panel type) should contain integral locking features and visual indication that the connector is properly seated and locked.
		EC-04	All electrical connectors should be keyed or asymmetrically shaped to ensure proper alignment.
		EC-05	All electrical connectors should contain scoop-proof shells to ensure pin damage will not occur prior to engaging key way.
		EC-06	All electrical connectors should be corrosion resistant to reduce or eliminate the need for scheduled inspections or corrosion prevention measures.
		EC-07	Avoid using electrical connectors requiring any type or form of soldering.
		EC-08	Locate and position electrical connectors such that all pin identification for either half can be easily seen.
		EC-09	Electrical connectors selected for critical applications on ground vehicles should be both accessible and capable of being connected disconnected by a fifty percentile gloved male hand.
		EC-10	Separation between grouped electrical connectors should be sufficient to ensure make or break of any connector by a fifty percentile gloved male hand. Where this is not possible, an alternate method should be used such as the use of stand-offs, long-shelled connectors alternated with standard connectors, 180-degree connectors alternated with 90-degree connectors, or innovative equivalents.
		EC-11	Avoid connectors requiring potting as a method for environmental protection due to lengthy repair time and tendency for potting compound reversion.
		EC-12	Electrical penetrations into a compartment should not be on a vertical axis to ensure foreign matter does not enter connector.
		EC-13	Electrical, electronic, and coaxial interfaces between fixed and moveable surfaces should contain quick disconnects to simplify replacement of the moveable surface or the electronic module.
		EC-15	The removal or replacement of electronic equipment should not require the removal of any other piece of equipment or armament.
		EC-16	Select connectors so that contacts on the "live" or "hot" side of the connection are socket type rather than pin type to minimize personnel hazard and to prevent accidental shorting of live circuits.
		EC-17	Whenever possible, use self-locking connector plugs of a type not requiring safety wire.
		EC-18	All electric connectors should be environment resistant.
		EC-19	Connectors containing fiber optic contacts should, whenever possible, be mounted on a vertical surface to prevent particle and fluid contamination.
		EC-20	Use quick disconnect connectors where allowed and identify all pins on each connector.

Guidelines by Category (Cont'd)

Category No.	Category Title	Guideline No.	Guideline
2.06	Simplification		
		EG-01	Design feedback loops so that the loop can be broken during test to ensure that faults do not propagate to the point where they cannot be isolated.
		EG-02	Avoid using external feedback loops requiring complex circuitry to simulate feedback I/Os.
		EG-03	In rare instances when complex external feedback loops cannot be avoided, incorporate simple interruptible control points.
		EG-04	Avoid long sequences of vectors to initialize or alter device outputs to minimize potential testability problems.
		EG-05	Avoid the need to have test equipment generate complex, phased or time related signals.
		EG-06	Test points should be located on all circuit nodes that are useful in determining the module's health.
		EG-07	Test points should be designed so that functional circuitry cannot be damaged or degraded due to the routing or accidental shorting of a signal at a test point. Some type of test point isolation technique should be used (buffers, isolator, etc.).
		EG-08	Test points should be easily accessed and clearly marked.
		EG-10	Design redundant circuits to be independently testable to ensure errors are not masked.
		EG-11	To improve the probability of fault detection, avoid shorting signals together to achieve a specific test function or condition.
		EG-12	Incorporate concept for partitioning module functions to simplify test equipment or eliminate the need for ancillary test equipment.
		EG-13	Design oscillators or clocks that are resident on the module to be replaceable by a signal from a connector to avoid the need to synchronize ATE to on-board signals.
		ENG(G)-02	Use torque-limiting bolts or torque washers as engine mount attaching hardware to eliminate the need for torque wrenches.
		ENG(G)-03	Design hard points for hoisting or positioning the engine during installation and removal to be integral to the engine and capable of hoisting and supporting a fully-built-up engine package.
		ENG(G)-04	Do not use downward engine removal concepts that require jacking or hoisting of the ground vehicle.
		ENG(G)-05	Use concepts for removing ground vehicle engines from the front, rear, or side rather than from overhead (using hoisting).
		ENG(G)-06	The distance between the engine and firewall should ensure the access envelopes to lines, fittings, wiring, and adjustments will accommodate the 75 percentile male hand.
		ENG(G)-07	The distance between the cooling fan and radiator core should ensure that access envelopes will not require removal of the core.
		ENG(G)-08	The interface of the engine assembly to the engine compartment and structure should be designed to ensure all spark plugs, glo-plugs, and igniters can be replaced within 30 minutes elapsed time.
		ENG(G)-10	Design attaching hardware for all mechanical engine-to-vehicle interfaces to be captive and with integral safeties.
		ENG(G)-11	Use "torq-set" type clamps or equivalent in all cooling system hose interfaces to eliminate torque wrenches and the potential for error.
		ENG(G)-12	Provide a clear and viewable access envelope to fuel and oil filters.
		ENG(G)-13	Locate fuel filters to ensure no safety hazard will exist due to residual fuel during filter change.
		ENG(G)-14	Access envelopes to fuel and oil filters should not be in close proximity to exhaust manifolds or cooling system return lines.
		ENG(G)-15	Any single drive belt (excluding timing belts) should be capable of replacement within 30 minutes elapsed time
		ENG(G)-18	Incorporate appropriate sensors to enhance the diagnostic and prognostic capabilities for the following: <ul style="list-style-type: none"> - Oil temperature - Fuel filter bypass - Oil pressure - Coolant pressure - Oil filter bypass - Coolant level - Oil cooler bypass valve position - Coolant temperature - Oil level - Vibration pickups - Oil return line particle count - Chip detector

Guidelines by Category (Cont'd)

Category No.	Category Title	Guideline No.	Guideline
2.06	Simplification	ENG(G)-19	Paint engine compartments gloss white to enhance light reflectivity and enhance fluid leak detection.
		ENG(G)-20	Design all firewall fittings, connectors, and penetrations to be fully viewable and directly accessible to the maintainers.
		ENG-01	All facets of engine design should take advantage of Electrostatic Engine Monitoring Systems (EEMS) and Inductive Debris Monitoring (IDM) toward achievement of on-condition maintenance and engine health monitoring.
		ENG-02	Each different component of rotating machinery should contain different tracer elements to enhance EEMS and IDM isolation and tracking of wear.
		ENG-03	Digital electronic controls, fully automatic digital electronic controls, and similar concepts should contain the highest degree of BIT and diagnostics commensurate with affordability, operation and maintenance, and life cycle costs as appropriate.
		ENG-05	All engine-mounted air and fluid lines should be located next to the fan case, engine case, or full-length fan duct to ensure quick and simple replacement of accessories and components.
		ENG-07	Plumbing and wiring spanning two or more engine modules should contain in-line disconnects to enhance and simplify engine modularization.
		ENG-08	Use V-band clamps to mount accessories to engine-mounted gear boxes.
		ENG-09	On multi-engine air vehicles, the engines should be capable of being installed in any engine cavity without need for reconfiguration.
		ENG-10	On multi-engine air vehicles, the airframe-to-engine interfaces should be in identical positions or orientations for each engine cavity.
		ENG-11	Control-by-wire or control-by-light throttling concepts should take precedence over mechanical controls.
		ENG-12	All engine-mounted accessories must be capable of being removed and installed through the available airframe access openings.
		ENG-13	Engine oil systems should contain on-board spectrometric oil analysis devices located on the engine.
		ENG-14	Coring of engine gear box cases and housings to provide for fuel heat sink routing should take precedence over dedicated fuel or oil heat exchangers.
		ENG-16	Aircraft jacking should not be required for engine removal.
		ENG-17	Aft engine removal should be an acceptable alternative for USAF aircraft.
		ENG-18	For either downward or aft engine removal, it should be possible to maintain control of the engine on all axis during the entire removal and installation process.
		ENG-19	The minimum clearance between engine and airframe should be 1 inch, including removal and installation.
		ENG-20	Do not locate equipment or components in the engine cavity except for those components associated with the engine or engine installation.
		ENG-21	Do not locate equipment or components in the engine bay cavity in a manner that would require removal or repositioning for engine removal.
		ENG-23	All engine borescope provisions should be accessible with the engine installed and hooked up.
		ENG-27	No rigging or calibration should be required following engine replacement.
		ENG-28	No engine operational start and checkout should be required following engine replacement.
		ENG-29	No functional check flight should be required following engine change. On twin engine aircraft where both engines were changed simultaneously, a functional test flight is permissible.
		ENG-30	It should not be necessary to close or reinstall engine access doors for engine ground operation up to and including military power.
		ENG-31	No rigging or calibration should be required subsequent to replacement of any engine-mounted component.
		ENG-32	Design the engine fuel controls and electronic controllers so that no manual fuel grade adjustments are required.
		ENG-36	All borescope mechanisms should have positive integral locking features.
		ENG-37	Gravity type servicing fittings, covers, and caps should have integral locking features, openable by hand, and contain a cable or chain to prevent loss or dropping.

Guidelines by Category (Cont'd)

Category No.	Category Title	Guideline No.	Guideline
2.06	Simplification	ENG-38	The characteristics of engine-to-vehicle interfaces coupled with the capabilities of electronic engine controls, should negate the necessity for making any type of engine rigging including maximum power, idle, and idle cut-off.
		ENG-39	Engine-to-vehicle plumbing quick disconnects should contain positive visual indication that the interface is fully seated and locked.
		ENG-40	Design of electronic engine controls should be such that no single failure of a sub-component within can result in over speed, over temperature, stagnation, or shut-down.
		ENG-42	Attach engine-to-inlet duct interface seals to the vehicle so they can be left in place during engine removal.
		ENG-43	Design engine-to-inlet duct seal so the interface is automatic during engine installation without needing any form of alignment, adjustment, or mechanical attachment interface.
		ENG-44	Select engine-to-inlet duct seal material to ensure seal life is sufficient for the life of the vehicle.
		ENG-45	Provide remote servicing points accessible from the ground to service engine accessories mounted on top of the engine (e.g., oil tanks, gear boxes, generators, etc.) to eliminate climbing upon or atop the host vehicle.
		ENG-49	Design engine fuel and oil filters with integral locking features so they can be installed and removed by hand, and require no torquing.
		ENG-50	Design engine fuel and oil filter delta pressure indicators so they can be reset only from within the filter housing.
		ENG-51	Provide engine fuel and oil filters with anti-surge protection to ensure false delta pressure indications do not occur.
		ENG-53	Design magnetic chip detectors to ensure that oil shut-off will occur as the detector is being removed for visual inspection.
		ENG-54	Incorporate provisions for fuzz burn-off in magnetic chip detectors.
		ENV-01	Materials, treatments, coatings, finishes should be compatible with all anti-ice and de-ice fluids, chemical and biological decontamination fluids, washing and cleaning fluids, and all vehicle subsystem fluids.
		ENV-02	There should be no top coat or treatment deterioration throughout the standard temperature and humidity spectrum.
		ENV-06	For ground vehicles, the finishes should be compatible with and durable against all rain, hail, sleet, snow, and ice conditions experienced in all intended operational environments.
		ENV-07	The finishes and surfaces should be capable of low velocity impact (LVI) of 10 foot-pounds with no visual or detectable damage with a design goal of 30 foot-pounds.
		F-01	Use blind fasteners only where absolutely necessary or where considerable cost can be saved.
		F-02	Minimize access fasteners while making them quick release, easily removed and replaced, and captive.
		F-03	Choose fasteners based on the requirement to operate by hand or with common hand tools rather than special tools.
		F-04	Whenever possible, incorporate barrel type fasteners as opposed to hi-torque fasteners. Failure of Hi-torque fasteners due to stripping are common and a source of potential foreign object damage (FOD).
		FI-01	Design each FI test to be independent of all other tests.
		FI-02	Design FI initiation to be subordinate to the higher priority predecessor tests.
		FI-03	Design each test so that it can be terminated prior to completion and then re-initiated at its start point.
		FI-04	Design the unit tests so that they can accommodate the following subsystem response modes: <ul style="list-style-type: none"> - Incorrect response - No response - Inconsistent response - Unexpected condition
		FI-05	Design all software so that it is structured by test priority. The test software should take advantage of both subroutine constructs for all message outputs and of failure dictionaries which identify the location of the most likely failed replaceable unit.
		FI-06	In an airborne avionics system, consider indicating mission critical faults on a pilots "head-up" display accompanied with an audible alarm, so that the pilot can easily check for critical system or mission threatening problems.
		FI-07	Ensure that system user manuals include instructions for faults not covered by BIT such as, system will not power up or system is being used in an incorrect environment such as, at the wrong altitude, etc.

Guidelines by Category (Cont'd)

Category No.	Category Title	Guideline No.	Guideline
2.06	Simplification		
		FI-08	Interlock the high power sections of systems and subsystems with visual/audible BIT to ensure safe system activation.
		FI-09	Design BIT to first conduct self-test for circuitry integrity before conducting system test.
		FI-10	Use clear text to report failures rather than alpha-numeric codes, lights, indicators, etc.
		FI-11	Locate BIT circuitry on the same level of the subsystem under test to simplify test and repair when it is removed from the main system.
		HOOK-05	Design tail hook points so they can not be incorrectly installed.
		HOOK-06	Avoid the need to remove the tail hook to facilitate engine access or removal.
		HYD-06	Mount hydraulic pumps to the gear box flange with v-band clamps containing a torq-set or equivalent fastener.
		HYD-07	Modularize electric-driven hydraulic pumps to enable replacement of the drive motor without interruption of the fluid lines.
		HYD-08	Design hydraulic pumps and motors with tracer elements to detect wear through on-board spectrometric oil analysis devices.
		HYD-11	Design flexible hose with molded-in color bands to clearly indicate when the maximum wear/abrasion has been reached.
		IN(V)-01	Design inlet door actuators and door actuation mechanisms so they not protrude into the air inlet flow field to eliminate FOD potential.
		IN(V)-06	Use captive fasteners on all access doors forward of the inlet to significantly reduce engine FOD potential.
		IN(V)-07	Ensure that no ground safety pins or streamers are used forward of the inlet or within a 3-foot radius aft of the inlet.
		IN(V)-08	Incorporate an inlet closure door sealing concept that prevents entry of fluid, dust, or sand across the entire airborne and ground environment spectrum.
		IN-01	Low Observable (LO) engine face frames should be within 10 inches of the first stage fan or compressor blades.
		IN-02	Openings throughout the engine face frame should be sufficient to perform a 100% FOD inspection of the engine face.
		IN-03	Openings throughout the engine face frame should be sufficient to permit minor blending or repair of FOD without removing the engine.
		IN-04	For frames not integral with the engine, frame removal should be achievable from the engine cavity.
		IN-05	Both integral and remote engine front frames should be interchangeable.
		IN-06	Front frame anti-ice and de-ice provisions should give preference to engine hot bleed air.
		LG-12	All struts should contain a spare strut lower seal stowed in the strut collar to avoid removing the lower strut for leak repair.
		LG-15	No portion of the landing gear closure door(s) should be attached to the strut. In rare instances where this may not be possible, that attached portion should not require alignment or rigging.
		LG-16	No portion of the landing gear rigging process should require support equipment type templates, gauges, or tools. Indexes, reference points, etc., should be an integral part of the landing gear/airframe design.
		LG-17	Hydraulic, pneumatic, or electrical actuators associated with landing gear systems should not require adjustment or rigging once installed in the air vehicle. Spare units should be rigged at the time of manufacture or overhaul.
		LG-18	Landing gear ground safety down locks should be an integral part of the overall design. Use or reliance on loose pins (support equipment) should be avoided.
		LG-19	When deemed necessary for the respective design, pilots, flight crews, or operators should have an indication of the downlock status in the cockpit or crew station to avoid the necessity of a flight abort.
		LG-20	Special locks and pins used solely for landing gear ground maintenance safety should be used only in those cases substantiated by cost effectiveness analysis.
		LG-23	Design strut fittings for servicing nitrogen or hydraulic fluid to be easily accessible and adjacent to the appropriate strut pressure gage.
		LG-24	Design struts so they can be serviced with clean, dry air in lieu of nitrogen during deployments without affecting the overall reliability.
		LG-26	Gravitational emergency extension of landing gear should be given preference over all other concepts.
		MATL-06	Repair criteria, repairs, and instructions should not be classified.

Guidelines by Category (Cont'd)

Category No.	Category Title	Guideline No.	Guideline
2.06	Simplification		
		MC-01	All clamps should contain torque-set or torque-limiting connections to prevent clamp or component failure due to over-torque. Clamp installation call outs should not depend on special tools to establish the required torque values.
		MC-02	Avoid the use of cotter pins, safety wire, safety clips, and similar devices to prevent maintenance-induced events leading to ground vehicle accidents or loss of air vehicles.
		MC-03	All tubing connections and interfaces should use rosan/dynatube (or equivalent) to (1) enable connect or disconnect with one hand, one tool, (2) eliminate the need to safety the connection, (3) provide a superior seal, and (4) negate need to reposition line(s) during component replacement.
		MC-04	No trombone type, flared tube type, or piloted line type interfaces should be used to avoid the need for removal or repositioning during equipment removal.
		MC-05	Avoid potential foreign object traps during manufacturing or operational maintenance by eliminating vertical penetrations of plumbing/fittings into tanks, compartments, or cells
		MC-06	Locate, position, orient all plumbing and duct electrical connectors to prevent the need for sequential installation or removal.
		MC-07	Maximize areas of constant web thickness in firewalls, carry-through bulkheads, major frames, structural ribs, spars, webs, keels, and close-outs to provide flexibility in locating penetration fittings. Stepped chem milling, stepped machining, stepped composite layup concepts all tend to result in minimal available surface area for penetrations.
		MC-08	All in-line plumbing connections within a fuel tank or cell should be capable of making/breaking the interface by hand, require no torque, contain integral safety locking mechanisms, and should be void of any requirement for safety wire.
		MC-09	All plumbing connections and fittings used for fuel systems should contain integral bonding features to eliminate the need for bonding clamps or jumper cables.
		MC-10	In rare instances where a plumbing run contains complex form or geometry that would require removal of other plumbing or equipment for access, in-line connectors should be incorporated to maintain the integrity of other plumbing or equipment.
		MC-11	No subsystem plumbing, equipment, or wiring should use a tank, cell, or compartment containing liquids as a means for routing or penetration simplicity during manufacture.
		MC-12	All plumbing and connectors containing liquids should be meniscus-free.
		MC-13	In instances where plumbing or connector interfaces cannot or are not keyed for a specific orientation, all identification, markings, cautions, and directions should be placed 360 degrees around the tube or duct.
		MC-14	Where multiple connectors are located in close proximity, ensure (1) a minimum hand tool arc of 120 degrees can be maintained, and (2) stagger fittings to ensure firm coupling interface/hand tool interface can be accomplished without inducing damage to adjacent lines.
		MC-15	Route, orient, and position plumbing, wiring, ducts, and connectors sufficiently away from the outer surface of the vehicle to preclude induced damage due to minor dents, drill bits during repair, etc. Minimum rule of thumb is 1" away from the inner surface and 1" below a plate nut channel.
		MG-03	Clearly mark all subsystems/LRUs to make system integration, test, debug, and repair easier.
		MP-01	Avoid the use of epoxies to mount parts on repairable modules because they make repair extremely difficult.
		MP-02	Use a unique identification (ID) resistor incorporated in each system module to verify that the proper module is mounted on ATE.
		MP-03	Design modules so that lengthy warm-up times, special coding and air purity levels, and similar constraints are not necessary.
		PYRO-01	Provide the "safe/arm" status to the pilot, crew, or gunner in the cockpit, crew station, or operator station as appropriate.
		PYRO-02	Provide the "safe/arm" status as an external cue discernible from a distance of 10-20 feet.
		PYRO-42	In weapons carriage design and integration, avoid dependence of on-board high pressure nitrogen.
		R-01	Large radomes wherein the combination of the diameter and length exceeds 60" should be top-hinged. Hinge should be load-carrying to reduce radome retention fastener count.
		R-02	Radome and radar array support structure design and material selection should eliminate the need for LO type fillers or shrouds.

Guidelines by Category (Cont'd)

Category No.	Category Title	Guideline No.	Guideline		
2.06	Simplification	SEAT-04	Design ejection seats so they can be replaced with canopy or escape hatch installed.		
		SEAT-06	Do not use seat removal as a means of access.		
		SIMP-01	Location and design of all exterior lights should not require protective covers in ground environments.		
		SIMP-02	Landing and taxi lights should be mounted on landing gear struts or doors to eliminate separate compartments, doors, and retraction/extension mechanisms.		
		SIMP-03	Speed brake or speed brake cavity should contain integral mechanical locking mechanism for personnel safety.		
		TP-01	Locate Input/Output (I/O) test points and associated readouts in close proximity to each other so that one person can perform testing.		
		TP-02	Protect test points against the environment and from induced contamination.		
		TP-03	Protect test points from outside signal generation.		
		W-01	Hat section type structural stiffeners with sufficient cross sectional area should be considered as a routing tunnel for wiring and coax.		
		WBAY-01	Equipment bays and compartments should not require installation of special cavity fillers when equipment is not installed.		
		WBAY-21	Coatings and finishes in the area of gun barrels should be durable to withstand the effect of exiting projectile shockwaves.		
		WBAY-22	The proximity of the gun blast deflector to structure should not require reliance on high-temperature paints or coatings to protect the structure.		
		2.07	Modularization	BIT-05	Incorporate testability design features as an integral part of equipment preliminary design process.
				BIT-14	Provide access to all BIT control and status signals at module connector pins. This will enable ATE to directly connect to BIT circuitry.
				BIT-15	Incorporate complete BIT functions and BITE on module. If only a portion of the BIT routine or BITE circuitry exists on the module, then ATE cannot utilize the BIT routine without providing the missing BIT functions.
				BIT-21	The failure detection function should provide the equipment operator with a go/no-go indication of equipment readiness.
				BIT-22	The BIT should be designed so that auxiliary test devices or external equipment are not needed for daily and other regular checks.
				BIT-23	Design BIT so it is initiated automatically upon equipment power-up.
				BIT-24	Test points should be functionally grouped together and clearly labeled for convenience and ease of maintenance.
BIT-25	Equipment should not require manual probing to fault isolate.				
BIT-26	Locate routinely used test points so they are accessible without removing or disassembling other equipment				
BIT-27	Periodic and initiated BIT should detect at least 98% of all failures and isolate a minimum 99% of those failures detected to a single LRU or WRA.				
BIT-28	Design BIT to have the same level of EMI protection as the system or equipment being monitored.				
CREW-05	Structural instrument panels, dashboards, and control panels should be modularized for easy and adequate access to all interfaces, to simplify manufacturing, and to reduce maintenance-induced problems.				
CREW-06	Film magazines, tapes, and removable modules should permit considerable handling without reliance on special support equipment protection.				
EG-01	Design feedback loops so that the loop can be broken during test to ensure that faults do not propagate to the point where they cannot be isolated.				
EG-02	Avoid using external feedback loops requiring complex circuitry to simulate feedback I/Os.				
EG-03	In rare instances when complex external feedback loops cannot be avoided, incorporate simple interruptible control points.				
EG-04	Avoid long sequences of vectors to initialize or alter device outputs to minimize potential testability problems.				
EG-05	Avoid the need to have test equipment generate complex, phased or time related signals.				
EG-06	Test points should be located on all circuit nodes that are useful in determining the module's health.				
EG-07	Test points should be designed so that functional circuitry cannot be damaged or degraded due to the routing or accidental shorting of a signal at a test point. Some type of test point isolation technique should be used (buffers, isolator, etc.).				

Guidelines by Category (Cont'd)

Category No.	Category Title	Guideline No.	Guideline
2.07	Modularization		
		EG-08	Test points should be easily accessed and clearly marked.
		EG-10	Design redundant circuits to be independently testable to ensure errors are not masked.
		EG-11	To improve the probability of fault detection, avoid shorting signals together to achieve a specific test function or condition.
		EG-12	Incorporate concept for partitioning module functions to simplify test equipment or eliminate the need for ancillary test equipment.
		EG-13	Design oscillators or clocks that are resident on the module to be replaceable by a signal from a connector to avoid the need to synchronize ATE to on-board signals.
		ENG-02	Each different component of rotating machinery should contain different tracer elements to enhance EEMS and IDM isolation and tracking of wear.
		FI-01	Design each FI test to be independent of all other tests.
		FI-03	Design each test so that it can be terminated prior to completion and then re-initiated at its start point.
		FI-04	Design the unit tests so that they can accommodate the following subsystem response modes: <ul style="list-style-type: none"> - Incorrect response - No response - Inconsistent response - Unexpected condition
		FI-05	Design all software so that it is structured by test priority. The test software should take advantage of both subroutine constructs for all message outputs and of failure dictionaries which identify the location of the most likely failed replaceable unit.
		FI-06	In an airborne avionics system, consider indicating mission critical faults on a pilots "head-up" display accompanied with an audible alarm, so that the pilot can easily check for critical system or mission threatening problems.
		FI-07	Ensure that system user manuals include instructions for faults not covered by BIT such as, system will not power up or system is being used in an incorrect environment such as, at the wrong altitude, etc.
		FI-08	Interlock the high power sections of systems and subsystems with visual/audible BIT to ensure safe system activation.
		FI-09	Design BIT to first conduct self-test for circuitry integrity before conducting system test.
		FI-10	Use clear text to report failures rather than alpha-numeric codes, lights, indicators, etc.
		FI-11	Locate BIT circuitry on the same level of the subsystem under test to simplify test and repair when it is removed from the main system.
		HYD-07	Modularize electric-driven hydraulic pumps to enable replacement of the drive motor without interruption of the fluid lines.
		MC-02	Avoid the use of cotter pins, safety wire, safety clips, and similar devices to prevent maintenance-induced events leading to ground vehicle accidents or loss of air vehicles.
		MC-09	All plumbing connections and fittings used for fuel systems should contain integral bonding features to eliminate the need for bonding clamps or jumper cables.
		MG-01	Mount LRUs/sub-systems on drawer slides or extender racks to provide easier accessibility during integration, testing, debug, and repair of Units Under Test (UUTs).
		MG-02	Use a modular system design so that each subassembly is designed as a functionally complete entity. Then when a subassembly was removed for testing, ATE will not need custom circuitry to simulate missing functions.
		MG-03	Clearly mark all subsystems/LRUs to make system integration, test, debug, and repair easier.
		MP-01	Avoid the use epoxies to mount parts on repairable modules because they make repair extremely difficult.
		MP-02	Use a unique identification (ID) resistor incorporated in each system module to verify that the proper module is mounted on ATE.
		MP-03	Design modules so that lengthy warm-up times, special coding and air purity levels, and similar constraints are not necessary.

Guidelines by Category (Cont'd)

Category No.	Category Title	Guideline No.	Guideline
2.07	Modularization	TP-01	Locate Input/Output (I/O) test points and associated readouts in close proximity to each other so that one person can perform testing.
		TP-02	Protect test points against the environment and from induced contamination.
2.08	Testability and Diagnostic Techniques	TP-03	Protect test points from outside signal generation.
		BIT-01	During design of the BIT, use worst-case stress analysis to ensure that any circuit failures induced by temperature extremes, tolerance build-up, power supply variations, and combinations thereof are identified
		BIT-02	Ensure that BIT system thresholds are consistent with those across the system, subsystem, item, module, and piece-part levels to prevent excessive numbers of Cannot Duplicate (CND) and Retest OK (RTOK) events from occurring.
		BIT-03	The degree of BIT required or proposed should be based on the respective failure rates and the appropriate FMECA at all equipment indenture levels.
		BIT-04	Limit the amount of data that is recorded to a manageable size by: - Limiting the number of signals that are monitored - Limiting the maximum sampling rate - Reducing the time span over which data is accumulated - Restricting the type of data accumulated
		BIT-05	Incorporate testability design features as an integral part of equipment preliminary design process.
		BIT-06	Mission critical functions should be monitored by BIT.
		BIT-07	Set BIT tolerances to maximize fault detection and minimize false alarm rate in the expected operating environment.
		BIT-08	Design BIT fault detectors to accommodate the needs of operator maintenance personnel.
		BIT-09	Use concurrent BIT to monitor system critical functions.
		BIT-10	Design the BIT and BITE so that no fault or failure within the BIT or BITE will degrade, disrupt, or fail the system being monitored.
		BIT-11	In the area of software design and test responsibility, the responsibility for the design and development of verification testing of an end item (e.g., digital filter) should reside with the same engineer(s).
		BIT-12	Define stimuli and response data for each diagnostic test at the system/subsystem level. The same data should be planned for use both in factory testing as well as in field maintenance of the equipment. These data minimize the amount of unique software to be written.
		BIT-13	Provide for manual control to test sequences, so that the test can be selected individually, and appropriate test combinations can be executed at the operator's discretion.
		BIT-14	Provide access to all BIT control and status signals at module connector pins. This will enable ATE to directly connect to BIT circuitry.
		BIT-15	Incorporate complete BIT functions and BITE on module. If only a portion of the BIT routine or BITE circuitry exists on the module, then ATE cannot utilize the BIT routine without providing the missing BIT functions.
		BIT-16	Critical voltages should be visually monitored by sending the voltage signals to visible LEDs.
BIT-17	BIT failures should be latched on the module. This makes it easier for the system or ATE to poll the error bit at any time.		
BIT-18	If many BIT routines exist on a module, then ATE should have access and the ability to control each routine individually.		
BIT-19	Design BIT to have a very low false alarm rate; otherwise BIT will not be an effective maintenance tool. As a goal, the false alarm rate should be 1% or less.		
BIT-20	The BIT should be mechanized so that when a piece of equipment is not installed in a subsystem or the product, a failure will not be indicated.		
BIT-21	The failure detection function should provide the equipment operator with a go/no-go indication of equipment readiness.		
BIT-22	The BIT should be designed so that auxiliary test devices or external equipment are not needed for daily and other regular checks.		
BIT-23	Design BIT so it is initiated automatically upon equipment power-up.		
BIT-24	Test points should be functionally grouped together and clearly labeled for convenience and ease of maintenance.		
BIT-25	Equipment should not require manual probing to fault isolate.		

Guidelines by Category (Cont'd)

Category No.	Category Title	Guideline No.	Guideline
2.08	Testability and Diagnostic Techniques		
		BIT-26	Locate routinely used test points so they are accessible without removing or disassembling other equipment
		BIT-27	Periodic and initiated BIT should detect at least 98% of all failures and isolate a minimum 99% of those failures detected to a single LRU or WRA.
		BIT-28	Design BIT to have the same level of EMI protection as the system or equipment being monitored.
		BIT/BITE-01	Design to keep false alarm rates below 1%. Higher false alarm rates can limit the effectiveness of BIT as a maintenance tool.
		BIT/BITE-02	Design EMI protection to eliminate finger type EMI contact devices.
		CO-01	Design automated systems and programs with provisions to enable "stop test" and "resume" without the need to cycle back or repeat the entire test.
		CO-02	In the event of program loss or hang-up, automated systems and programs should have provisions for reverting to manual test and operation.
		CO-03	Use a test connector to provide test and maintenance bus access to all system and subsystem faults.
		CO-04	Design systems and subsystems so that ATE can be used to access, read, and control internal components in concert with the test or checkout program.
		CO-05	Avoid the need for costly adapters for signal communications between system, subsystems, line replaceable units (LRUs) or Weapon Replaceable Assemblies (WRAs), and ATE.
		EG-01	Design feedback loops so that the loop can be broken during test to ensure that faults do not propagate to the point where they cannot be isolated.
		EG-02	Avoid using external feedback loops requiring complex circuitry to simulate feedback I/Os.
		EG-03	In rare instances when complex external feedback loops cannot be avoided, incorporate simple interruptible control points.
		EG-04	Avoid long sequences of vectors to initialize or alter device outputs to minimize potential testability problems.
		EG-05	Avoid the need to have test equipment generate complex, phased or time related signals.
		EG-06	Test points should be located on all circuit nodes that are useful in determining the module's health.
		EG-07	Test points should be designed so that functional circuitry cannot be damaged or degraded due to the routing or accidental shorting of a signal at a test point. Some type of test point isolation technique should be used (buffers, isolator, etc.).
		EG-08	Test points should be easily accessed and clearly marked.
		EG-10	Design redundant circuits to be independently testable to ensure errors are not masked.
		EG-11	To improve the probability of fault detection, avoid shorting signals together to achieve a specific test function or condition.
		EG-12	Incorporate concept for partitioning module functions to simplify test equipment or eliminate the need for ancillary test equipment.
		EG-13	Design oscillators or clocks that are resident on the module to be replaceable by a signal from a connector to avoid the need to synchronize ATE to on-board signals.
		ENG(G)-18	Incorporate appropriate sensors to enhance the diagnostic and prognostic capabilities for the following: <ul style="list-style-type: none"> - Oil temperature - Fuel filter bypass - Oil pressure - Coolant pressure - Oil filter bypass - Coolant level - Oil cooler bypass valve position - Coolant temperature - Oil level - Vibration pickups - Oil return line particle count - Chip detector
		ENG-01	All facets of engine design should take advantage of Electrostatic Engine Monitoring Systems (EEMS) and Inductive Debris Monitoring (IDM) toward achievement of on-condition maintenance and engine health monitoring.
		ENG-02	Each different component of rotating machinery should contain different tracer elements to enhance EEMS and IDM isolation and tracking of wear.

Guidelines by Category (Cont'd)

Category No.	Category Title	Guideline No.	Guideline
2.08	Testability and Diagnostic Techniques	ENG-03	Digital electronic controls, fully automatic digital electronic controls, and similar concepts should contain the highest degree of BIT and diagnostics commensurate with affordability, operation and maintenance, and life cycle costs as appropriate.
		ENG-36	All borecope mechanisms should have positive integral locking features.
		ENG-37	Gravity type servicing fittings, covers, and caps should have integral locking features, openable by hand, and contain a cable or chain to prevent loss or dropping.
		ENG-40	Design of electronic engine controls should be such that no single failure of a sub-component within can result in over speed, over temperature, stagnation, or shut-down.
		FI-01	Design each FI test to be independent of all other tests.
		FI-02	Design FI initiation to be subordinate to the higher priority predecessor tests.
		FI-03	Design each test so that it can be terminated prior to completion and then re-initiated at its start point.
		FI-04	Design the unit tests so that they can accommodate the following subsystem response modes: <ul style="list-style-type: none"> - Incorrect response - No response - Inconsistent response - Unexpected condition
		FI-05	Design all software so that it is structured by test priority. The test software should take advantage of both subroutine constructs for all message outputs and of failure dictionaries which identify the location of the most likely failed replaceable unit.
		FI-06	In an airborne avionics system, consider indicating mission critical faults on a pilots "head-up" display accompanied with an audible alarm, so that the pilot can easily check for critical system or mission threatening problems.
		FI-07	Ensure that system user manuals include instructions for faults not covered by BIT such as, system will not power up or system is being used in an incorrect environment such as, at the wrong altitude, etc.
		FI-08	Interlock the high power sections of systems and subsystems with visual/audible BIT to ensure safe system activation.
		FI-09	Design BIT to first conduct self-test for circuitry integrity before conducting system test.
		FI-10	Use clear text to report failures rather than alpha-numeric codes, lights, indicators, etc.
		FI-11	Locate BIT circuitry on the same level of the subsystem under test to simplify test and repair when it is removed from the main system.
		HYD-08	Design hydraulic pumps and motors with tracer elements to detect wear through on-board spectrometric oil analysis devices.
		OXY-11	System operational and service condition status should be capable of being downlinked to centralized maintenance facilities.
		PYRO-15	Pylon-to-weapon and pylon-to-air vehicle electrical interfaces should contain built-in test/fault location capabilities.
		TCR-08	Incorporate vibration pick-up sensors to isolate the respective unit from other potential sources of vibration, and to enhance the prognostic potential for monitoring equipment health.
		TP-01	Locate Input/Output (I/O) test points and associated readouts in close proximity to each other so that one person can perform testing.
		TP-02	Protect test points against the environment and from induced contamination.
		TP-03	Protect test points from outside signal generation.
		WT&B-07	Landing gear caution and warning systems should contain both initiated and periodic BIT and be capable of fault-isolating to each component in the system.
		WT&B-15	Anti-skid and anti-lock brake systems should contain periodic and initiated BIT. All components, including speed sensors, comparators, wiring, connectors, control boxes, etc., should be included in the BIT system.
2.08.01	System Testability Design	BIT-01	During design of the BIT, use worst-case stress analysis to ensure that any circuit failures induced by temperature extremes, tolerance build-up, power supply variations, and combinations thereof are identified.

Guidelines by Category (Cont'd)

Category No.	Category Title	Guideline No.	Guideline
2.08.01	System Testability Design	BIT-02	Ensure that BIT system thresholds are consistent with those across the system, subsystem, item, module, and piece-part levels to prevent excessive numbers of Cannot Duplicate (CND) and Retest OK (RTOK) events from occurring.
		BIT-03	The degree of BIT required or proposed should be based on the respective failure rates and the appropriate FMECA at all equipment indeture levels.
		BIT-04	Limit the amount of data that is recorded to a manageable size by: <ul style="list-style-type: none"> - Limiting the number of signals that are monitored - Limiting the maximum sampling rate - Reducing the time span over which data is accumulated - Restricting the type of data accumulated
		BIT-05	Incorporate testability design features as an integral part of equipment preliminary design process.
		BIT-06	Mission critical functions should be monitored by BIT.
		BIT-07	Set BIT tolerances to maximize fault detection and minimize false alarm rate in the expected operating environment.
		BIT-08	Design BIT fault detectors to accommodate the needs of operator maintenance personnel.
		BIT-09	Use concurrent BIT to monitor system critical functions.
		BIT-10	Design the BIT and BITE so that no fault or failure within the BIT or BITE will degrade, disrupt, or fail the system being monitored.
		BIT-11	In the area of software design and test responsibility, the responsibility for the design and development of verification testing of an end item (e.g., digital filter) should reside with the same engineer(s).
		BIT-12	Define stimuli and response data for each diagnostic test at the system/subsystem level. The same data should be planned for use both in factory testing as well as in field maintenance of the equipment. These data minimize the amount of unique software to be written.
		BIT-13	Provide for manual control to test sequences, so that the test can be selected individually, and appropriate test combinations can be executed at the operator's discretion.
		BIT-14	Provide access to all BIT control and status signals at module connector pins. This will enable ATE to directly connect to BIT circuitry.
		BIT-15	Incorporate complete BIT functions and BITE on module. If only a portion of the BIT routine or BITE circuitry exists on the module, then ATE cannot utilize the BIT routine without providing the missing BIT functions.
		BIT-16	Critical voltages should be visually monitored by sending the voltage signals to visible LEDs.
		BIT-17	BIT failures should be latched on the module. This makes it easier for the system or ATE to poll the error bit at any time.
		BIT-18	If many BIT routines exist on a module, then ATE should have access and the ability to control each routine individually.
		BIT-19	Design BIT to have a very low false alarm rate; otherwise BIT will not be an effective maintenance tool. As a goal, the false alarm rate should be 1% or less.
		BIT-21	The failure detection function should provide the equipment operator with a go/no-go indication of equipment readiness.
		BIT-22	The BIT should be designed so that auxiliary test devices or external equipment are not needed for daily and other regular checks.
		BIT-23	Design BIT so it is initiated automatically upon equipment power-up.
		BIT-24	Test points should be functionally grouped together and clearly labeled for convenience and ease of maintenance.
		BIT-25	Equipment should not require manual probing to fault isolate.
		BIT-26	Locate routinely used test points so they are accessible without removing or disassembling other equipment
		BIT-27	Periodic and initiated BIT should detect at least 98% of all failures and isolate a minimum 99% of those failures detected to a single LRU or WRA.
		BIT-28	Design BIT to have the same level of EMI protection as the system or equipment being monitored.
		BIT/BITE-01	Design to keep false alarm rates below 1%. Higher false alarm rates can limit the effectiveness of BIT as a maintenance tool.
		BIT/BITE-02	Design EMI protection to eliminate finger type EMI contact devices.
		CC-11	Orient spare wires and cable pigtails along the outer diameter or periphery of connectors to make access easier.

Guidelines by Category (Cont'd)

Category No.	Category Title	Guideline No.	Guideline
2.08.01	System Testability Design		
		CC-12	Build up and assemble straight and angle connector shells or back shells in a manner that ensures that wire or cable strain or wear is not possible.
		CO-01	Design automated systems and programs with provisions to enable "stop test" and "resume" without the need to cycle back or repeat the entire test.
		CO-02	In the event of program loss or hang-up, automated systems and programs should have provisions for reverting to manual test and operation.
		CO-03	Use a test connector to provide test and maintenance bus access to all system and subsystem faults.
		CO-04	Design systems and subsystems so that ATE can be used to access, read, and control internal components in concert with the test or checkout program.
		CO-05	Avoid the need for costly adapters for signal communications between system, subsystems, line replaceable units (LRUs) or Weapon Replaceable Assemblies (WRAs), and ATE.
		EG-01	Design feedback loops so that the loop can be broken during test to ensure that faults do not propagate to the point where they cannot be isolated.
		EG-02	Avoid using external feedback loops requiring complex circuitry to simulate feedback I/Os.
		EG-03	In rare instances when complex external feedback loops cannot be avoided, incorporate simple interruptible control points.
		EG-04	Avoid long sequences of vectors to initialize or alter device outputs to minimize potential testability problems.
		EG-05	Avoid the need to have test equipment generate complex, phased or time related signals.
		EG-06	Test points should be located on all circuit nodes that are useful in determining the module's health.
		EG-07	Test points should be designed so that functional circuitry cannot be damaged or degraded due to the routing or accidental shorting of a signal at a test point. Some type of test point isolation technique should be used (buffers, isolator, etc.).
		EG-08	Test points should be easily accessed and clearly marked.
		EG-10	Design redundant circuits to be independently testable to ensure errors are not masked.
		EG-11	To improve the probability of fault detection, avoid shorting signals together to achieve a specific test function or condition.
		EG-12	Incorporate concept for partitioning module functions to simplify test equipment or eliminate the need for ancillary test equipment.
		EG-13	Design oscillators or clocks that are resident on the module to be replaceable by a signal from a connector to avoid the need to synchronize ATE to on-board signals.
		ENG(G)-18	Incorporate appropriate sensors to enhance the diagnostic and prognostic capabilities for the following: <ul style="list-style-type: none"> - Oil temperature - Oil pressure - Oil filter bypass - Oil cooler bypass valve position - Oil level - Oil return line particle count
		ENG-01	All facets of engine design should take advantage of Electrostatic Engine Monitoring Systems (EEMS) and Inductive Debris Monitoring (IDM) toward achievement of on-condition maintenance and engine health monitoring.
		ENG-02	Each different component of rotating machinery should contain different tracer elements to enhance EEMS and IDM isolation and tracking of wear.
		ENG-03	Digital electronic controls, fully automatic digital electronic controls, and similar concepts should contain the highest degree of BIT and diagnostics commensurate with affordability, operation and maintenance, and life cycle costs as appropriate.
		ENG-36	All borescope mechanisms should have positive integral locking features.
		ENG-38	The characteristics of engine-to-vehicle interfaces coupled with the capabilities of electronic engine controls, should negate the necessity for making any type of engine rigging including maximum power, idle, and idle cut-off.
		FI-01	Design each FI test to be independent of all other tests.

Guidelines by Category (Cont'd)

Category No.	Category Title	Guideline No.	Guideline
2.08.01	System Testability Design	FI-02	Design FI initiation to be subordinate to the higher priority predecessor tests.
		FI-03	Design each test so that it can be terminated prior to completion and then re-initiated at its start point.
		FI-04	Design the unit tests so that they can accommodate the following subsystem response modes: <ul style="list-style-type: none"> - Incorrect response - No response - Inconsistent response - Unexpected condition
		FI-05	Design all software so that it is structured by test priority. The test software should take advantage of both subroutine constructs for all message outputs and of failure dictionaries which identify the location of the most likely failed replaceable unit.
		FI-06	In an airborne avionics system, consider indicating mission critical faults on a pilots "head-up" display accompanied with an audible alarm, so that the pilot can easily check for critical system or mission threatening problems.
		FI-07	Ensure that system user manuals include instructions for faults not covered by BIT such as, system will not power up or system is being used in an incorrect environment such as, at the wrong altitude, etc.
		FI-08	Interlock the high power sections of systems and subsystems with visual/audible BIT to ensure safe system activation.
		FI-09	Design BIT to first conduct self-test for circuitry integrity before conducting system test.
		FI-10	Use clear text to report failures rather than alpha-numeric codes, lights, indicators, etc.
		FI-11	Locate BIT circuitry on the same level of the subsystem under test to simplify test and repair when it is removed from the main system.
		OXY-01	System should contain automatic BIT for warning indicators to eliminate dedicated test switches and/or test requirements.
		OXY-11	System operational and service condition status should be capable of being downlinked to centralized maintenance facilities.
		PYRO-15	Pylon-to-weapon and pylon-to-air vehicle electrical interfaces should contain built-in test/fault location capabilities.
		TCR-08	Incorporate vibration pick-up sensors to isolate the respective unit from other potential sources of vibration, and to enhance the prognostic potential for monitoring equipment health.
		TP-01	Locate Input/Output (I/O) test points and associated readouts in close proximity to each other so that one person can perform testing.
		TP-02	Protect test points against the environment and from induced contamination.
		TP-03	Protect test points from outside signal generation.
		WT&B-07	Landing gear caution and warning systems should contain both initiated and periodic BIT and be capable of fault-isolating to each component in the system.
		WT&B-15	Anti-skid and anti-lock brake systems should contain periodic and initiated BIT. All components, including speed sensors, comparators, wiring, connectors, control boxes, etc., should be included in the BIT system.
		A-11	Locate compartment electrical penetrations close to the access opening for ease of sight, probing, repair, and to eliminate fluid soaking, wicking, or contamination.
		A-12	Locate compartment electrical penetrations far enough from the access opening to prevent damage resulting from improper (over-length) panel fasteners.
		A-13	Two-sided or two-surfaced access should not be required for access to equipment interfaces and hardpoints. The term two-sided infers top/bottom, left/right, front/back, or combinations thereof.
		ACS-10	Ensure all diagnostic and prognostic logic, intelligence, and status type informational data are storable and viewable within the crew station.
		ACS-11	Provide crew station personnel with the capability to manually initiate selective BIT and interrogate the prognostics system without interrupting the full-time or periodic BIT routines.
2.08.02	System/Subsystem Built-in-Test/Built-in-Test Equipment (BIT/BITE)	BIT-01	During design of the BIT, use worst-case stress analysis to ensure that any circuit failures induced by temperature extremes, tolerance build-up, power supply variations, and combinations thereof are identified.

Guidelines by Category (Cont'd)

Category No.	Category Title	Guideline No.	Guideline
2.08.02	System/Subsystem Built-in-Test/Built-in-Test Equipment (BIT/BITE)	BIT-02	Ensure that BIT system thresholds are consistent with those across the system, subsystem, item, module, and piece-part levels to prevent excessive numbers of Cannot Duplicate (CND) and Retest OK (RTOK) events from occurring.
		BIT-03	The degree of BIT required or proposed should be based on the respective failure rates and the appropriate FMECA at all equipment indeture levels.
		BIT-04	Limit the amount of data that is recorded to a manageable size by: <ul style="list-style-type: none"> - Limiting the number of signals that are monitored - Limiting the maximum sampling rate - Reducing the time span over which data is accumulated - Restricting the type of data accumulated
		BIT-05	Incorporate testability design features as an integral part of equipment preliminary design process.
		BIT-06	Mission critical functions should be monitored by BIT.
		BIT-07	Set BIT tolerances to maximize fault detection and minimize false alarm rate in the expected operating environment.
		BIT-08	Design BIT fault detectors to accommodate the needs of operator maintenance personnel.
		BIT-09	Use concurrent BIT to monitor system critical functions.
		BIT-10	Design the BIT and BITE so that no fault or failure within the BIT or BITE will degrade, disrupt, or fail the system being monitored.
		BIT-11	In the area of software design and test responsibility, the responsibility for the design and development of verification testing of an end item (e.g., digital filter) should reside with the same engineer(s).
		BIT-12	Define stimuli and response data for each diagnostic test at the system/subsystem level. The same data should be planned for use both in factory testing as well as in field maintenance of the equipment. These data minimize the amount of unique software to be written.
		BIT-13	Provide for manual control to test sequences, so that the test can be selected individually, and appropriate test combinations can be executed at the operator's discretion.
		BIT-14	Provide access to all BIT control and status signals at module connector pins. This will enable ATE to directly connect to BIT circuitry.
		BIT-15	Incorporate complete BIT functions and BITE on module. If only a portion of the BIT routine or BITE circuitry exists on the module, then ATE cannot utilize the BIT routine without providing the missing BIT functions.
		BIT-16	Critical voltages should be visually monitored by sending the voltage signals to visible LEDs.
		BIT-17	BIT failures should be latched on the module. This makes it easier for the system or ATE to poll the error bit at any time.
		BIT-18	If many BIT routines exist on a module, then ATE should have access and the ability to control each routine individually.
		BIT-19	Design BIT to have a very low false alarm rate; otherwise BIT will not be an effective maintenance tool. As a goal, the false alarm rate should be 1% or less.
		BIT-20	The BIT should be mechanized so that when a piece of equipment is not installed in a subsystem or the product, a failure will not be indicated.
		BIT-21	The failure detection function should provide the equipment operator with a go/no-go indication of equipment readiness.
		BIT-22	The BIT should be designed so that auxiliary test devices or external equipment are not needed for daily and other regular checks.
		BIT-23	Design BIT so it is initiated automatically upon equipment power-up.
		BIT-24	Test points should be functionally grouped together and clearly labeled for convenience and ease of maintenance.
		BIT-25	Equipment should not require manual probing to fault isolate.
		BIT-26	Locate routinely used test points so they are accessible without removing or disassembling other equipment
		BIT-27	Periodic and initiated BIT should detect at least 98% of all failures and isolate a minimum 99% of those failures detected to a single LRU or WRA.
		BIT-28	Design BIT to have the same level of EMI protection as the system or equipment being monitored.
		BIT/BITE-01	Design to keep false alarm rates below 1%. Higher false alarm rates can limit the effectiveness of BIT as a maintenance tool.

Guidelines by Category (Cont'd)

Category No.	Category Title	Guideline No.	Guideline
2.08.02	System/Subsystem Built-in-Test/Built-in-Test Equipment (BIT/BITE)		
		BIT/BITE-02	Design EMI protection to eliminate finger type EMI contact devices.
		CC-01	Use fiber-optic technologies in preference to conventional interconnect concepts to reduce the number of interconnects/interfaces, reduce manufacturing and ownership costs, and significantly improve R&M.
		CC-02	Standardize connector and wire types to improve testability and logistic support. Keep the number of "different" standard connectors to a minimum. Use the same connector type keyed differently where possible.
		CC-03	Provide clearance around connectors for engagement/disengagement of cables and proper connector orientation under anticipated environmental conditions (e.g., bare hand of 50 percentile male in an enclosed or protected environment and a gloved hand of a 50 percentile male in an open or unprotected environment).
		CC-04	Use quick release cables and locate cables to make removal and replacement easy and to avoid having to remove one cable to gain access to another. Provide adequate space for cables, including sleeving and tie-downs, and adequate service loops for ease of assembly/disassembly
		CC-05	Orient and space connectors to allow a sufficient grip on the connector for cable or wire extraction without fear of using the wiring or cable for additional leverage.
		CC-06	Label, and where possible color code, each wire in a harness or cable to facilitate tracking from origin to termination. Each wire, cable, and coax-to-connector interface should be provided with a source of identification to aid in trouble shooting, repair, or modification. Marking the cable designator on the cable along with bar codes is also recommended.
		CC-07	Do not manufacture or dress connectors containing more than 25 wires or cables as a single integrated harness. Group the wires or cables into runs of no more than 25 wires or cables each. In addition to making trouble shooting and repair easier, this approach help avoid large bend radii, thereby simplifying routing, packaging, and stowage.
		CC-08	Standardize connector pin assignments for power, ground, and other frequently used signals.
		CC-09	Locate LRU/subsystem critical nodes (and or test points) so they are accessible from a connector to prevent the need for internal LRU probing or access.
		CC-10	Avoid hidden cables. Visually inspecting and tracing all assembly cables rather than having hidden cables (such as behind other cables or even LRUs) allows for a quick system and cable integrity check which aids in overall system integrity and debug. This also implies quick access for manipulative actions.
		CC-11	Orient spare wires and cable pigtaills along the outer diameter or periphery of connectors to make access easier.
		CC-12	Build up and assemble straight and angle connector shells or back shells in a manner that ensures that wire or cable strain or wear is not possible.
		CO-01	Design automated systems and programs with provisions to enable "stop test" and "resume" without the need to cycle back or repeat the entire test.
		CO-02	In the event of program loss or hang-up, automated systems and programs should have provisions for reverting to manual test and operation.
		CO-03	Use a test connector to provide test and maintenance bus access to all system and subsystem faults.
		CO-04	Design systems and subsystems so that ATE can be used to access, read, and control internal components in concert with the test or checkout program.
		CO-05	Avoid the need for costly adapters for signal communications between system, subsystems, line replaceable units (LRUs) or Weapon Replaceable Assemblies (WRAs), and ATE.
		EG-01	Design feedback loops so that the loop can be broken during test to ensure that faults do not propagate to the point where they cannot be isolated.
		EG-02	Avoid using external feedback loops requiring complex circuitry to simulate feedback I/Os.
		EG-03	In rare instances when complex external feedback loops cannot be avoided, incorporate simple interruptible control points.
		EG-04	Avoid long sequences of vectors to initialize or alter device outputs to minimize potential testability problems.
		EG-05	Avoid the need to have test equipment generate complex, phased or time related signals.
		EG-06	Test points should be located on all circuit nodes that are useful in determining the module's health.
		EG-07	Test points should be designed so that functional circuitry cannot be damaged or degraded due to the routing or accidental shorting of a signal at a test point. Some type of test point isolation technique should be used (buffers, isolator, etc.).

Guidelines by Category (Cont'd)

Category No.	Category Title	Guideline No.	Guideline
2.08.02	System/Subsystem Built-in-Test/Built-in-Test Equipment (BIT/BITE)	EG-08	Test points should be easily accessed and clearly marked.
		EG-10	Design redundant circuits to be independently testable to ensure errors are not masked.
		EG-11	To improve the probability of fault detection, avoid shorting signals together to achieve a specific test function or condition.
		EG-12	Incorporate concept for partitioning module functions to simplify test equipment or eliminate the need for ancillary test equipment.
		EG-13	Design oscillators or clocks that are resident on the module to be replaceable by a signal from a connector to avoid the need to synchronize ATE to on-board signals.
		ENG(G)-18	Incorporate appropriate sensors to enhance the diagnostic and prognostic capabilities for the following: <ul style="list-style-type: none"> - Oil temperature - Oil pressure - Oil filter bypass - Oil cooler bypass valve position - Oil level - Oil return line particle count
		ENG-01	All facets of engine design should take advantage of Electrostatic Engine Monitoring Systems (EEMS) and Inductive Debris Monitoring (IDM) toward achievement of on-condition maintenance and engine health monitoring.
		ENG-02	Each different component of rotating machinery should contain different tracer elements to enhance EEMS and IDM isolation and tracking of wear.
		ENG-03	Digital electronic controls, fully automatic digital electronic controls, and similar concepts should contain the highest degree of BIT and diagnostics commensurate with affordability, operation and maintenance, and life cycle costs as appropriate.
		ENG-38	The characteristics of engine-to-vehicle interfaces coupled with the capabilities of electronic engine controls, should negate the necessity for making any type of engine rigging including maximum power, idle, and idle cut-off.
		FI-01	Design each FI test to be independent of all other tests.
		FI-02	Design FI initiation to be subordinate to the higher priority predecessor tests.
		FI-03	Design each test so that it can be terminated prior to completion and then re-initiated at its start point.
		FI-04	Design the unit tests so that they can accommodate the following subsystem response modes: <ul style="list-style-type: none"> - Incorrect response - No response - Inconsistent response - Unexpected condition
		FI-05	Design all software so that it is structured by test priority. The test software should take advantage of both subroutine constructs for all message outputs and of failure dictionaries which identify the location of the most likely failed replaceable unit.
		FI-06	In an airborne avionics system, consider indicating mission critical faults on a pilots "head-up" display accompanied with an audible alarm, so that the pilot can easily check for critical system or mission threatening problems.
		FI-07	Ensure that system user manuals include instructions for faults not covered by BIT such as, system will not power up or system is being used in an incorrect environment such as, at the wrong altitude, etc.
		FI-08	Interlock the high power sections of systems and subsystems with visual/audible BIT to ensure safe system activation.
		FI-09	Design BIT to first conduct self-test for circuitry integrity before conducting system test.
		FI-10	Use clear text to report failures rather than alpha-numeric codes, lights, indicators, etc.
		FI-11	Locate BIT circuitry on the same level of the subsystem under test to simplify test and repair when it is removed from the main system.
		HYD-08	Design hydraulic pumps and motors with tracer elements to detect wear through on-board spectrometric oil analysis devices.

Guidelines by Category (Cont'd)

Category No.	Category Title	Guideline No.	Guideline
2.08.02	System/Subsystem Built-in-Test/Built-in-Test Equipment (BIT/BITE)	MC-10	In rare instances where a plumbing run contains complex form or geometry that would require removal of other plumbing or equipment for access, in-line connectors should be incorporated to maintain the integrity of other plumbing or equipment.
		MC-12	All plumbing and connectors containing liquids should be meniscus-free.
		MC-14	Where multiple connectors are located in close proximity, ensure (1) a minimum hand tool arc of 120 degrees can be maintained, and (2) stagger fittings to ensure firm coupling interface/hand tool interface can be accomplished without inducing damage to adjacent lines.
		MG-01	Mount LRUs/sub-systems on drawer slides or extender racks to provide easier accessibility during integration, testing, debug, and repair of Units Under Test (UUTs).
		MG-02	Use a modular system design so that each subassembly is designed as a functionally complete entity. Then when a subassembly was removed for testing, ATE will not need custom circuitry to simulate missing functions.
		MG-03	Clearly mark all subsystems/LRUs to make system integration, test, debug, and repair easier.
		MP-01	Avoid the use of epoxies to mount parts on repairable modules because they make repair extremely difficult.
		MP-02	Use a unique identification (ID) resistor incorporated in each system module to verify that the proper module is mounted on ATE.
		MP-03	Design modules so that lengthy warm-up times, special coding and air purity levels, and similar constraints are not necessary.
		OXY-01	System should contain automatic BIT for warning indicators to eliminate dedicated test switches and/or test requirements.
		PYRO-15	Pylon-to-weapon and pylon-to-air vehicle electrical interfaces should contain built-in test/fault location capabilities.
		TP-01	Locate Input/Output (I/O) test points and associated readouts in close proximity to each other so that one person can perform testing.
		TP-02	Protect test points against the environment and from induced contamination.
		TP-03	Protect test points from outside signal generation.
		WT&B-07	Landing gear caution and warning systems should contain both initiated and periodic BIT and be capable of fault-isolating to each component in the system.
		WT&B-15	Anti-skid and anti-lock brake systems should contain periodic and initiated BIT. All components, including speed sensors, comparators, wiring, connectors, control boxes, etc., should be included in the BIT system.
		ACS-10	Ensure all diagnostic and prognostic logic, intelligence, and status type informational data are storable and viewable within the crew station.
		ACS-11	Provide crew station personnel with the capability to manually initiate selective BIT and interrogate the prognostics system without interrupting the full-time or periodic BIT routines.
		BIT-01	During design of the BIT, use worst-case stress analysis to ensure that any circuit failures induced by temperature extremes, tolerance build-up, power supply variations, and combinations thereof are identified.
		BIT-02	Ensure that BIT system thresholds are consistent with those across the system, subsystem, item, module, and piece-part levels to prevent excessive numbers of Cannot Duplicate (CND) and Retest OK (RTOK) events from occurring.
		BIT-03	The degree of BIT required or proposed should be based on the respective failure rates and the appropriate FMECA at all equipment indenture levels.
		BIT-04	Limit the amount of data that is recorded to a manageable size by: <ul style="list-style-type: none"> - Limiting the number of signals that are monitored - Limiting the maximum sampling rate - Reducing the time span over which data is accumulated - Restricting the type of data accumulated
		BIT-05	Incorporate testability design features as an integral part of equipment preliminary design process.
		BIT-06	Mission critical functions should be monitored by BIT.
		BIT-07	Set BIT tolerances to maximize fault detection and minimize false alarm rate in the expected operating environment.
		BIT-08	Design BIT fault detectors to accommodate the needs of operator maintenance personnel.
2.08.03	Module Level Testability Guidelines		

Guidelines by Category (Cont'd)

Category No.	Category Title	Guideline No.	Guideline
2.08.03	Module Level Testability Guidelines		
		BIT-09	Use concurrent BIT to monitor system critical functions.
		BIT-10	Design the BIT and BITE so that no fault or failure within the BIT or BITE will degrade, disrupt, or fail the system being monitored.
		BIT-11	In the area of software design and test responsibility, the responsibility for the design and development of verification testing of an end item (e.g., digital filter) should reside with the same engineer(s).
		BIT-12	Define stimuli and response data for each diagnostic test at the system/subsystem level. The same data should be planned for use both in factory testing as well as in field maintenance of the equipment. These data minimize the amount of unique software to be written.
		BIT-16	Critical voltages should be visually monitored by sending the voltage signals to visible LEDs.
		BIT-17	BIT failures should be latched on the module. This makes it easier for the system or ATE to poll the error bit at any time.
		BIT-18	If many BIT routines exist on a module, then ATE should have access and the ability to control each routine individually.
		BIT-19	Design BIT to have a very low false alarm rate; otherwise BIT will not be an effective maintenance tool. As a goal, the false alarm rate should be 1% or less.
		BIT-20	The BIT should be mechanized so that when a piece of equipment is not installed in a subsystem or the product, a failure will not be indicated.
		BIT-21	The failure detection function should provide the equipment operator with a go/no-go indication of equipment readiness.
		BIT-22	The BIT should be designed so that auxiliary test devices or external equipment are not needed for daily and other regular checks.
		BIT-23	Design BIT so it is initiated automatically upon equipment power-up.
		BIT-24	Test points should be functionally grouped together and clearly labeled for convenience and ease of maintenance.
		BIT-25	Equipment should not require manual probing to fault isolate.
		BIT-26	Locate routinely used test points so they are accessible without removing or disassembling other equipment
		BIT-27	Periodic and initiated BIT should detect at least 98% of all failures and isolate a minimum 99% of those failures detected to a single LRU or WRA.
		BIT-28	Design BIT to have the same level of EMI protection as the system or equipment being monitored.
		BIT/BITE-01	Design to keep false alarm rates below 1%. Higher false alarm rates can limit the effectiveness of BIT as a maintenance tool.
		BIT/BITE-02	Design EMI protection to eliminate finger type EMI contact devices.
		CC-01	Use fiber-optic technologies in preference to conventional interconnect concepts to reduce the number of interconnects/interfaces, reduce manufacturing and ownership costs, and significantly improve R&M.
		CC-02	Standardize connector and wire types to improve testability and logistic support. Keep the number of "different" standard connectors to a minimum. Use the same connector type keyed differently where possible.
		CC-03	Provide clearance around connectors for engagement/disengagement of cables and proper connector orientation under anticipated environmental conditions (e.g., bare hand of 50 percentile male in an enclosed or protected environment and a gloved hand of a 50 percentile male in an open or unprotected environment).
		CC-04	Use quick release cables and locate cables to make removal and replacement easy and to avoid having to remove one cable to gain access to another. Provide adequate space for cables, including sleeving and tie-downs, and adequate service loops for ease of assembly/disassembly.
		CC-05	Orient and space connectors to allow a sufficient grip on the connector for cable or wire extraction without fear of using the wiring or cable for additional leverage.
		CC-06	Label, and where possible color code, each wire in a harness or cable to facilitate tracking from origin to termination. Each wire, cable, and coax-to-connector interface should be provided with a source of identification to aid in trouble shooting, repair, or modification. Marking the cable designator on the cable along with bar codes is also recommended.
		CC-07	Do not manufacture or dress connectors containing more than 25 wires or cables as a single integrated harness. Group the wires or cables into runs of no more than 25 wires or cables each. In addition to making trouble shooting and repair easier, this approach help avoid large bend radii, thereby simplifying routing, packaging, and stowage.

Guidelines by Category (Cont'd)

Category No.	Category Title	Guideline No.	Guideline
2.08.03	Module Level Testability Guidelines		
		CC-08	Standardize connector pin assignments for power, ground, and other frequently used signals.
		CC-09	Locate LRU/subsystem critical nodes (and or test points) so they are accessible from a connector to prevent the need for internal LRU probing or access.
		CC-10	Avoid hidden cables. Visually inspecting and tracing all assembly cables rather than having hidden cables (such as behind other cables or even LRUs) allows for a quick system and cable integrity check which aids in overall system integrity and debug. This also implies quick access for manipulative actions.
		CO-01	Design automated systems and programs with provisions to enable "stop test" and "resume" without the need to cycle back or repeat the entire test.
		CO-02	In the event of program loss or hang-up, automated systems and programs should have provisions for reverting to manual test and operation.
		CO-03	Use a test connector to provide test and maintenance bus access to all system and subsystem faults.
		CO-04	Design systems and subsystems so that ATE can be used to access, read, and control internal components in concert with the test or checkout program.
		CO-05	Avoid the need for costly adapters for signal communications between system, subsystems, line replaceable units (LRUs) or Weapon Replaceable Assemblies (WRAs), and ATE.
		EG-01	Design feedback loops so that the loop can be broken during test to ensure that faults do not propagate to the point where they cannot be isolated.
		EG-02	Avoid using external feedback loops requiring complex circuitry to simulate feedback I/Os.
		EG-03	In rare instances when complex external feedback loops cannot be avoided, incorporate simple interruptible control points.
		EG-04	Avoid long sequences of vectors to initialize or alter device outputs to minimize potential testability problems.
		EG-05	Avoid the need to have test equipment generate complex, phased or time related signals.
		EG-06	Test points should be located on all circuit nodes that are useful in determining the module's health.
		EG-07	Test points should be designed so that functional circuitry cannot be damaged or degraded due to the routing or accidental shorting of a signal at a test point. Some type of test point isolation technique should be used (buffers, isolator, etc.).
		EG-08	Test points should be easily accessed and clearly marked.
		EG-10	Design redundant circuits to be independently testable to ensure errors are not masked.
		EG-11	To improve the probability of fault detection, avoid shorting signals together to achieve a specific test function or condition.
		EG-12	Incorporate concept for partitioning module functions to simplify test equipment or eliminate the need for ancillary test equipment.
		EG-13	Design oscillators or clocks that are resident on the module to be replaceable by a signal from a connector to avoid the need to synchronize ATE to on-board signals.
		ENG-02	Each different component of rotating machinery should contain different tracer elements to enhance EEMS and IDM isolation and tracking of wear.
		FI-01	Design each FI test to be independent of all other tests.
		FI-02	Design FI initiation to be subordinate to the higher priority predecessor tests.
		FI-03	Design each test so that it can be terminated prior to completion and then re-initiated at its start point.
		FI-04	Design the unit tests so that they can accommodate the following subsystem response modes: <ul style="list-style-type: none"> - Incorrect response - No response - Inconsistent response - Unexpected condition
		FI-05	Design all software so that it is structured by test priority. The test software should take advantage of both subroutine constructs for all message outputs and of failure dictionaries which identify the location of the most likely failed replaceable unit.

Guidelines by Category (Cont'd)

Category No.	Category Title	Guideline No.	Guideline
2.08.03	Module Level Testability Guidelines	FI-06	In an airborne avionics system, consider indicating mission critical faults on a pilots "head-up" display accompanied with an audible alarm, so that the pilot can easily check for critical system or mission threatening problems.
		FI-07	Ensure that system user manuals include instructions for faults not covered by BIT such as, system will not power up or system is being used in an incorrect environment such as, at the wrong altitude, etc.
		FI-08	Interlock the high power sections of systems and subsystems with visual/audible BIT to ensure safe system activation.
		FI-09	Design BIT to first conduct self-test for circuitry integrity before conducting system test.
		FI-10	Use clear text to report failures rather than alpha-numeric codes, lights, indicators, etc.
		FI-11	Locate BIT circuitry on the same level of the subsystem under test to simplify test and repair when it is removed from the main system.
		MG-02	Use a modular system design so that each subassembly is designed as a functionally complete entity. Then when a subassembly was removed for testing, ATE will not need custom circuitry to simulate missing functions.
		MG-03	Clearly mark all subsystems/LRUs to make system integration, test, debug, and repair easier.
		MP-01	Avoid the use epoxies to mount parts on repairable modules because they make repair extremely difficult.
		MP-02	Use a unique identification (ID) resistor incorporated in each system module to verify that the proper module is mounted on ATE.
		MP-03	Design modules so that lengthy warm-up times, special coding and air purity levels, and similar constraints are not necessary.
		TP-01	Locate Input/Output (I/O) test points and associated readouts in close proximity to each other so that one person can perform testing.
		TP-02	Protect test points against the environment and from induced contamination.
		TP-03	Protect test points from outside signal generation.
		ACS-10	Ensure all diagnostic and prognostic logic, intelligence, and status type informational data are storable and viewable within the crew station.
		ACS-11	Provide crew station personnel with the capability to manually initiate selective BIT and interrogate the prognostics system without interrupting the full-time or periodic BIT routines.
		BIT-01	During design of the BIT, use worst-case stress analysis to ensure that any circuit failures induced by temperature extremes, tolerance build-up, power supply variations, and combinations thereof are identified.
		BIT-02	Ensure that BIT system thresholds are consistent with those across the system, subsystem, item, module, and piece-part levels to prevent excessive numbers of Cannot Duplicate (CND) and Retest OK (RTOK) events from occurring.
		BIT-03	The degree of BIT required or proposed should be based on the respective failure rates and the appropriate FMECA at all equipment indenture levels.
		BIT-04	Limit the amount of data that is recorded to a manageable size by: <ul style="list-style-type: none"> - Limiting the number of signals that are monitored - Limiting the maximum sampling rate - Reducing the time span over which data is accumulated - Restricting the type of data accumulated
		BIT-05	Incorporate testability design features as an integral part of equipment preliminary design process.
		BIT-06	Mission critical functions should be monitored by BIT.
		BIT-07	Set BIT tolerances to maximize fault detection and minimize false alarm rate in the expected operating environment.
		BIT-08	Design BIT fault detectors to accommodate the needs of operator maintenance personnel.
		BIT-09	Use concurrent BIT to monitor system critical functions.
		BIT-10	Design the BIT and BITE so that no fault or failure within the BIT or BITE will degrade, disrupt, or fail the system being monitored.
		BIT-11	In the area of software design and test responsibility, the responsibility for the design and development of verification testing of an end item (e.g., digital filter) should reside with the same engineer(s).
2.09	Module BIT/BITE		

Guidelines by Category (Cont'd)

Category No.	Category Title	Guideline No.	Guideline
2.09	Module BIT/BITE	BIT-12	Define stimuli and response data for each diagnostic test at the system/subsystem level. The same data should be planned for use both in factory testing as well as in field maintenance of the equipment. These data minimize the amount of unique software to be written.
		BIT-13	Provide for manual control to test sequences, so that the test can be selected individually, and appropriate test combinations can be executed at the operator's discretion.
		BIT-14	Provide access to all BIT control and status signals at module connector pins. This will enable ATE to directly connect to BIT circuitry.
		BIT-15	Incorporate complete BIT functions and BITE on module. If only a portion of the BIT routine or BITE circuitry exists on the module, then ATE cannot utilize the BIT routine without providing the missing BIT functions.
		BIT-16	Critical voltages should be visually monitored by sending the voltage signals to visible LEDs.
		BIT-17	BIT failures should be latched on the module. This makes it easier for the system or ATE to poll the error bit at any time.
		BIT-18	If many BIT routines exist on a module, then ATE should have access and the ability to control each routine individually.
		BIT-19	Design BIT to have a very low false alarm rate; otherwise BIT will not be an effective maintenance tool. As a goal, the false alarm rate should be 1% or less.
		BIT-20	The BIT should be mechanized so that when a piece of equipment is not installed in a subsystem or the product, a failure will not be indicated.
		BIT-21	The failure detection function should provide the equipment operator with a go/no-go indication of equipment readiness.
		BIT-22	The BIT should be designed so that auxiliary test devices or external equipment are not needed for daily and other regular checks.
		BIT-23	Design BIT so it is initiated automatically upon equipment power-up.
		BIT-24	Test points should be functionally grouped together and clearly labeled for convenience and ease of maintenance.
		BIT-25	Equipment should not require manual probing to fault isolate.
		BIT-26	Locate routinely used test points so they are accessible without removing or disassembling other equipment
		BIT-27	Periodic and initiated BIT should detect at least 98% of all failures and isolate a minimum 99% of those failures detected to a single LRU or WRA.
		BIT-28	Design BIT to have the same level of EMI protection as the system or equipment being monitored.
		BIT/BITE-01	Design to keep false alarm rates below 1%. Higher false alarm rates can limit the effectiveness of BIT as a maintenance tool.
		BIT/BITE-02	Design EMI protection to eliminate finger type EMI contact devices.
		CC-11	Orient spare wires and cable pigtails along the outer diameter or periphery of connectors to make access easier.
		CC-12	Build up and assemble straight and angle connector shells or back shells in a manner that ensures that wire or cable strain or wear is not possible.
		CO-01	Design automated systems and programs with provisions to enable "stop test" and "resume" without the need to cycle back or repeat the entire test.
		CO-02	In the event of program loss or hang-up, automated systems and programs should have provisions for reverting to manual test and operation.
		CO-03	Use a test connector to provide test and maintenance bus access to all system and subsystem faults.
		CO-04	Design systems and subsystems so that ATE can be used to access, read, and control internal components in concert with the test or checkout program.
		CO-05	Avoid the need for costly adapters for signal communications between system, subsystems, line replaceable units (LRUs) or Weapon Replaceable Assemblies (WRAs), and ATE.
		ECS-06	All electrical control, sensing, sensor, warning, caution, or signal interface and wiring should be fully BIT compatible.
		EG-01	Design feedback loops so that the loop can be broken during test to ensure that faults do not propagate to the point where they cannot be isolated.
		EG-02	Avoid using external feedback loops requiring complex circuitry to simulate feedback I/Os.

Guidelines by Category (Cont'd)

Category No.	Category Title	Guideline No.	Guideline
2.09	Module BIT/BITE	EG-03	In rare instances when complex external feedback loops cannot be avoided, incorporate simple interruptible control points.
		EG-04	Avoid long sequences of vectors to initialize or alter device outputs to minimize potential testability problems.
		EG-05	Avoid the need to have test equipment generate complex, phased or time related signals.
		EG-06	Test points should be located on all circuit nodes that are useful in determining the module's health.
		EG-07	Test points should be designed so that functional circuitry cannot be damaged or degraded due to the routing or accidental shorting of a signal at a test point. Some type of test point isolation technique should be used (buffers, isolator, etc.).
		EG-08	Test points should be easily accessed and clearly marked.
		EG-10	Design redundant circuits to be independently testable to ensure errors are not masked.
		EG-11	To improve the probability of fault detection, avoid shorting signals together to achieve a specific test function or condition.
		EG-12	Incorporate concept for partitioning module functions to simplify test equipment or eliminate the need for ancillary test equipment.
		EG-13	Design oscillators or clocks that are resident on the module to be replaceable by a signal from a connector to avoid the need to synchronize ATE to on-board signals.
		ENG-13	Engine oil systems should contain on-board spectrometric oil analysis devices located on the engine.
		FI-01	Design each FI test to be independent of all other tests.
		FI-02	Design FI initiation to be subordinate to the higher priority predecessor tests.
		FI-03	Design each test so that it can be terminated prior to completion and then re-initiated at its start point.
		FI-04	Design the unit tests so that they can accommodate the following subsystem response modes: <ul style="list-style-type: none"> - Incorrect response - No response - Inconsistent response - Unexpected condition
		FI-05	Design all software so that it is structured by test priority. The test software should take advantage of both subroutine constructs for all message outputs and of failure dictionaries which identify the location of the most likely failed replaceable unit.
		FI-06	In an airborne avionics system, consider indicating mission critical faults on a pilots "head-up" display accompanied with an audible alarm, so that the pilot can easily check for critical system or mission threatening problems.
		FI-07	Ensure that system user manuals include instructions for faults not covered by BIT such as, system will not power up or system is being used in an incorrect environment such as, at the wrong altitude, etc.
		FI-08	Interlock the high power sections of systems and subsystems with visual/audible BIT to ensure safe system activation.
		FI-09	Design BIT to first conduct self-test for circuitry integrity before conducting system test.
		FI-10	Use clear text to report failures rather than alpha-numeric codes, lights, indicators, etc.
		FI-11	Locate BIT circuitry on the same level of the subsystem under test to simplify test and repair when it is removed from the main system.
		MG-02	Use a modular system design so that each subassembly is designed as a functionally complete entity. Then when a subassembly was removed for testing, ATE will not need custom circuitry to simulate missing functions.
		MP-01	Avoid the use epoxies to mount parts on repairable modules because they make repair extremely difficult.
		MP-02	Use a unique identification (ID) resistor incorporated in each system module to verify that the proper module is mounted on ATE.
		MP-03	Design modules so that lengthy warm-up times, special coding and air purity levels, and similar constraints are not necessary.
		PYRO-15	Pylon-to-weapon and pylon-to-air vehicle electrical interfaces should contain built-in test/fault location capabilities.
		TCR-08	Incorporate vibration pick-up sensors to isolate the respective unit from other potential sources of vibration, and to enhance the prognostic potential for monitoring equipment health.

Guidelines by Category (Cont'd)

Category No.	Category Title	Guideline No.	Guideline
2.09	Module BIT/BITE	TP-01	Locate Input/Output (I/O) test points and associated readouts in close proximity to each other so that one person can perform testing.
		TP-02	Protect test points against the environment and from induced contamination.
		TP-03	Protect test points from outside signal generation.
		WT&B-07	Landing gear caution and warning systems should contain both initiated and periodic BIT and be capable of fault-isolating to each component in the system.
		WT&B-15	Anti-skid and anti-lock brake systems should contain periodic and initiated BIT. All components, including speed sensors, comparators, wiring, connectors, control boxes, etc., should be included in the BIT system.
2.09.01	General BIT Techniques (applicable to any technology)	BIT-01	During design of the BIT, use worst-case stress analysis to ensure that any circuit failures induced by temperature extremes, tolerance build-up, power supply variations, and combinations thereof are identified.
		BIT-02	Ensure that BIT system thresholds are consistent with those across the system, subsystem, item, module, and piece-part levels to prevent excessive numbers of Cannot Duplicate (CND) and Retest OK (RTOK) events from occurring.
		BIT-03	The degree of BIT required or proposed should be based on the respective failure rates and the appropriate FMECA at all equipment indenture levels.
		BIT-04	Limit the amount of data that is recorded to a manageable size by: <ul style="list-style-type: none"> - Limiting the number of signals that are monitored - Limiting the maximum sampling rate - Reducing the time span over which data is accumulated - Restricting the type of data accumulated
		BIT-05	Incorporate testability design features as an integral part of equipment preliminary design process.
		BIT-06	Mission critical functions should be monitored by BIT.
		BIT-07	Set BIT tolerances to maximize fault detection and minimize false alarm rate in the expected operating environment.
		BIT-08	Design BIT fault detectors to accommodate the needs of operator maintenance personnel.
		BIT-09	Use concurrent BIT to monitor system critical functions.
		BIT-10	Design the BIT and BITE so that no fault or failure within the BIT or BITE will degrade, disrupt, or fail the system being monitored.
		BIT-11	In the area of software design and test responsibility, the responsibility for the design and development of verification testing of an end item (e.g., digital filter) should reside with the same engineer(s).
		BIT-12	Define stimuli and response data for each diagnostic test at the system/subsystem level. The same data should be planned for use both in factory testing as well as in field maintenance of the equipment. These data minimize the amount of unique software to be written.
		BIT-13	Provide for manual control to test sequences, so that the test can be selected individually, and appropriate test combinations can be executed at the operator's discretion.
		BIT-14	Provide access to all BIT control and status signals at module connector pins. This will enable ATE to directly connect to BIT circuitry.
		BIT-15	Incorporate complete BIT functions and BITE on module. If only a portion of the BIT routine or BITE circuitry exists on the module, then ATE cannot utilize the BIT routine without providing the missing BIT functions.
		BIT-16	Critical voltages should be visually monitored by sending the voltage signals to visible LEDs.
		BIT-17	BIT failures should be latched on the module. This makes it easier for the system or ATE to poll the error bit at any time.
		BIT-18	If many BIT routines exist on a module, then ATE should have access and the ability to control each routine individually.
		BIT-19	Design BIT to have a very low false alarm rate; otherwise BIT will not be an effective maintenance tool. As a goal, the false alarm rate should be 1% or less.
		BIT-20	The BIT should be mechanized so that when a piece of equipment is not installed in a subsystem or the product, a failure will not be indicated.
		BIT-21	The failure detection function should provide the equipment operator with a go/no-go indication of equipment readiness.

Guidelines by Category (Cont'd)

Category No.	Category Title	Guideline No.	Guideline
2.09.01	General BIT Techniques (applicable to any technology)	BIT-22	The BIT should be designed so that auxiliary test devices or external equipment are not needed for daily and other regular checks.
		BIT-23	Design BIT so it is initiated automatically upon equipment power-up.
		BIT-24	Test points should be functionally grouped together and clearly labeled for convenience and ease of maintenance.
		BIT-25	Equipment should not require manual probing to fault isolate.
		BIT-26	Locate routinely used test points so they are accessible without removing or disassembling other equipment.
		BIT-27	Periodic and initiated BIT should detect at least 98% of all failures and isolate a minimum 99% of those failures detected to a single LRU or WRA.
		BIT-28	Design BIT to have the same level of EMI protection as the system or equipment being monitored.
		BIT/BITE-01	Design to keep false alarm rates below 1%. Higher false alarm rates can limit the effectiveness of BIT as a maintenance tool.
		BIT/BITE-02	Design EMI protection to eliminate finger type EMI contact devices.
		CC-01	Use fiber-optic technologies in preference to conventional interconnect concepts to reduce the number of interconnects/interfaces, reduce manufacturing and ownership costs, and significantly improve R&M.
		CC-02	Standardize connector and wire types to improve testability and logistic support. Keep the number of "different" standard connectors to a minimum. Use the same connector type keyed differently where possible.
		CC-03	Provide clearance around connectors for engagement/disengagement of cables and proper connector orientation under anticipated environmental conditions (e.g., bare hand of 50 percentile male in an enclosed or protected environment and a gloved hand of a 50 percentile male in an open or unprotected environment).
		CC-04	Use quick release cables and locate cables to make removal and replacement easy and to avoid having to remove one cable to gain access to another. Provide adequate space for cables, including sleeving and tie-downs, and adequate service loops for ease of assembly/disassembly.
		CC-05	Orient and space connectors to allow a sufficient grip on the connector for cable or wire extraction without fear of using the wiring or cable for additional leverage.
		CC-06	Label, and where possible color code, each wire in a harness or cable to facilitate tracking from origin to termination. Each wire, cable, and coax-to-connector interface should be provided with a source of identification to aid in trouble shooting, repair, or modification. Marking the cable designator on the cable along with bar codes is also recommended.
		CC-07	Do not manufacture or dress connectors containing more than 25 wires or cables as a single integrated harness. Group the wires or cables into runs of no more than 25 wires or cables each. In addition to making trouble shooting and repair easier, this approach help avoid large bend radii, thereby simplifying routing, packaging, and stowage.
		CC-08	Standardize connector pin assignments for power, ground, and other frequently used signals.
		CC-09	Locate LRU/subsystem critical nodes (and or test points) so they are accessible from a connector to prevent the need for internal LRU probing or access.
		CC-10	Avoid hidden cables. Visually inspecting and tracing all assembly cables rather than having hidden cables (such as behind other cables or even LRUs) allows for a quick system and cable integrity check which aids in overall system integrity and debug. This also implies quick access for manipulative actions.
		CC-11	Orient spare wires and cable pigtails along the outer diameter or periphery of connectors to make access easier.
		CC-12	Build up and assemble straight and angle connector shells or back shells in a manner that ensures that wire or cable strain or wear is not possible.
		CO-01	Design automated systems and programs with provisions to enable "stop test" and "resume" without the need to cycle back or repeat the entire test.
		CO-02	In the event of program loss or hang-up, automated systems and programs should have provisions for reverting to manual test and operation.
		CO-03	Use a test connector to provide test and maintenance bus access to all system and subsystem faults.
		CO-04	Design systems and subsystems so that ATE can be used to access, read, and control internal components in concert with the test or checkout program.

Guidelines by Category (Cont'd)

Category No.	Category Title	Guideline No.	Guideline
2.09.01	General BIT Techniques (applicable to any technology)	CO-05	Avoid the need for costly adapters for signal communications between system, subsystems, line replaceable units (LRUs) or Weapon Replaceable Assemblies (WRAs), and ATE.
		ECS-06	All electrical control, sensing, sensor, warning, caution, or signal interface and wiring should be fully BIT compatible.
		EG-01	Design feedback loops so that the loop can be broken during test to ensure that faults do not propagate to the point where they cannot be isolated.
		EG-02	Avoid using external feedback loops requiring complex circuitry to simulate feedback I/Os.
		EG-03	In rare instances when complex external feedback loops cannot be avoided, incorporate simple interruptible control points.
		EG-04	Avoid long sequences of vectors to initialize or alter device outputs to minimize potential testability problems.
		EG-05	Avoid the need to have test equipment generate complex, phased or time related signals.
		EG-06	Test points should be located on all circuit nodes that are useful in determining the module's health.
		EG-07	Test points should be designed so that functional circuitry cannot be damaged or degraded due to the routing or accidental shorting of a signal at a test point. Some type of test point isolation technique should be used (buffers, isolator, etc.).
		EG-08	Test points should be easily accessed and clearly marked.
		EG-10	Design redundant circuits to be independently testable to ensure errors are not masked.
		EG-11	To improve the probability of fault detection, avoid shorting signals together to achieve a specific test function or condition.
		EG-12	Incorporate concept for partitioning module functions to simplify test equipment or eliminate the need for ancillary test equipment.
		EG-13	Design oscillators or clocks that are resident on the module to be replaceable by a signal from a connector to avoid the need to synchronize ATE to on-board signals.
		ENG(G)-18	Incorporate appropriate sensors to enhance the diagnostic and prognostic capabilities for the following: <ul style="list-style-type: none"> - Oil temperature - Oil pressure - Oil filter bypass - Oil cooler bypass valve position - Oil level - Oil return line particle count
		ENG-01	All facets of engine design should take advantage of Electrostatic Engine Monitoring Systems (EEMS) and Inductive Debris Monitoring (IDM) toward achievement of on-condition maintenance and engine health monitoring.
		ENG-02	Each different component of rotating machinery should contain different tracer elements to enhance EEMS and IDM isolation and tracking of wear.
		ENG-03	Digital electronic controls, fully automatic digital electronic controls, and similar concepts should contain the highest degree of BIT and diagnostics commensurate with affordability, operation and maintenance, and life cycle costs as appropriate.
		ENG-13	Engine oil systems should contain on-board spectrometric oil analysis devices located on the engine.
		ENG-38	The characteristics of engine-to-vehicle interfaces coupled with the capabilities of electronic engine controls, should negate the necessity for making any type of engine rigging including maximum power, idle, and idle cut-off.
		FI-01	Design each FI test to be independent of all other tests.
		FI-02	Design FI initiation to be subordinate to the higher priority predecessor tests.
		FI-03	Design each test so that it can be terminated prior to completion and then re-initiated at its start point.
		FI-04	Design the unit tests so that they can accommodate the following subsystem response modes: <ul style="list-style-type: none"> - Incorrect response - No response - Inconsistent response - Unexpected condition

Guidelines by Category (Cont'd)

Category No.	Category Title	Guideline No.	Guideline
2.09.01	General BIT Techniques (applicable to any technology)	FI-05	Design all software so that it is structured by test priority. The test software should take advantage of both subroutine constructs for all message outputs and of failure dictionaries which identify the location of the most likely failed replaceable unit.
		FI-06	In an airborne avionics system, consider indicating mission critical faults on a pilots "head-up" display accompanied with an audible alarm, so that the pilot can easily check for critical system or mission threatening problems.
		FI-07	Ensure that system user manuals include instructions for faults not covered by BIT such as, system will not power up or system is being used in an incorrect environment such as, at the wrong altitude, etc.
		FI-08	Interlock the high power sections of systems and subsystems with visual/audible BIT to ensure safe system activation.
		FI-09	Design BIT to first conduct self-test for circuitry integrity before conducting system test.
		FI-10	Use clear text to report failures rather than alpha-numeric codes, lights, indicators, etc.
		FI-11	Locate BIT circuitry on the same level of the subsystem under test to simplify test and repair when it is removed from the main system.
		MP-01	Avoid the use of epoxies to mount parts on repairable modules because they make repair extremely difficult.
		MP-02	Use a unique identification (ID) resistor incorporated in each system module to verify that the proper module is mounted on ATE.
		MP-03	Design modules so that lengthy warm-up times, special coding and air purity levels, and similar constraints are not necessary.
		OXY-01	System should contain automatic BIT for warning indicators to eliminate dedicated test switches and/or test requirements.
		PYRO-15	Pylon-to-weapon and pylon-to-air vehicle electrical interfaces should contain built-in test/fault location capabilities.
		TCR-08	Incorporate vibration pick-up sensors to isolate the respective unit from other potential sources of vibration, and to enhance the prognostic potential for monitoring equipment health.
		TP-01	Locate Input/Output (I/O) test points and associated readouts in close proximity to each other so that one person can perform testing.
		TP-02	Protect test points against the environment and from induced contamination.
		TP-03	Protect test points from outside signal generation.
		WT&B-07	Landing gear caution and warning systems should contain both initiated and periodic BIT and be capable of fault-isolating to each component in the system.
		WT&B-15	Anti-skid and anti-lock brake systems should contain periodic and initiated BIT. All components, including speed sensors, comparators, wiring, connectors, control boxes, etc., should be included in the BIT system.
2.10	Inherent Testability Design Checklist	ACS-10	Ensure all diagnostic and prognostic logic, intelligence, and status type informational data are storable and viewable within the crew station.
		ACS-11	Provide crew station personnel with the capability to manually initiate selective BIT and interrogate the prognostics system without interrupting the full-time or periodic BIT routines.
		BIT-01	During design of the BIT, use worst-case stress analysis to ensure that any circuit failures induced by temperature extremes, tolerance build-up, power supply variations, and combinations thereof are identified.
		BIT-02	Ensure that BIT system thresholds are consistent with those across the system, subsystem, item, module, and piece-part levels to prevent excessive numbers of Cannot Duplicate (CND) and Retest OK (RTOK) events from occurring.
		BIT-03	The degree of BIT required or proposed should be based on the respective failure rates and the appropriate FMECA at all equipment indenture levels.
		BIT-04	Limit the amount of data that is recorded to a manageable size by: <ul style="list-style-type: none"> - Limiting the number of signals that are monitored - Limiting the maximum sampling rate - Reducing the time span over which data is accumulated - Restricting the type of data accumulated
		BIT-05	Incorporate testability design features as an integral part of equipment preliminary design process.
		BIT-06	Mission critical functions should be monitored by BIT.

Guidelines by Category (Cont'd)

Category No.	Category Title	Guideline No.	Guideline
2.10	Inherent Testability Design Checklist	BIT-07	Set BIT tolerances to maximize fault detection and minimize false alarm rate in the expected operating environment.
		BIT-08	Design BIT fault detectors to accommodate the needs of operator maintenance personnel.
		BIT-09	Use concurrent BIT to monitor system critical functions.
		BIT-10	Design the BIT and BITE so that no fault or failure within the BIT or BITE will degrade, disrupt, or fail the system being monitored.
		BIT-11	In the area of software design and test responsibility, the responsibility for the design and development of verification testing of an end item (e.g., digital filter) should reside with the same engineer(s).
		BIT-12	Define stimuli and response data for each diagnostic test at the system/subsystem level. The same data should be planned for use both in factory testing as well as in field maintenance of the equipment. These data minimize the amount of unique software to be written.
		BIT-13	Provide for manual control to test sequences, so that the test can be selected individually, and appropriate test combinations can be executed at the operator's discretion.
		BIT-14	Provide access to all BIT control and status signals at module connector pins. This will enable ATE to directly connect to BIT circuitry.
		BIT-15	Incorporate complete BIT functions and BITE on module. If only a portion of the BIT routine or BITE circuitry exists on the module, then ATE cannot utilize the BIT routine without providing the missing BIT functions.
		BIT-16	Critical voltages should be visually monitored by sending the voltage signals to visible LEDs.
		BIT-17	BIT failures should be latched on the module. This makes it easier for the system or ATE to poll the error bit at any time.
		BIT-18	If many BIT routines exist on a module, then ATE should have access and the ability to control each routine individually.
		BIT-19	Design BIT to have a very low false alarm rate; otherwise BIT will not be an effective maintenance tool. As a goal, the false alarm rate should be 1% or less.
		BIT-20	The BIT should be mechanized so that when a piece of equipment is not installed in a subsystem or the product, a failure will not be indicated.
		BIT-21	The failure detection function should provide the equipment operator with a go/no-go indication of equipment readiness.
		BIT-22	The BIT should be designed so that auxiliary test devices or external equipment are not needed for daily and other regular checks.
		BIT-23	Design BIT so it is initiated automatically upon equipment power-up.
		BIT-24	Test points should be functionally grouped together and clearly labeled for convenience and ease of maintenance.
		BIT-25	Equipment should not require manual probing to fault isolate.
		BIT-26	Locate routinely used test points so they are accessible without removing or disassembling other equipment
		BIT-27	Periodic and initiated BIT should detect at least 98% of all failures and isolate a minimum 99% of those failures detected to a single LRU or WRA.
		BIT-28	Design BIT to have the same level of EMI protection as the system or equipment being monitored.
		BIT/BITE-01	Design to keep false alarm rates below 1%. Higher false alarm rates can limit the effectiveness of BIT as a maintenance tool.
		BIT/BITE-02	Design EMI protection to eliminate finger type EMI contact devices.
		CC-01	Use fiber-optic technologies in preference to conventional interconnect concepts to reduce the number of interconnects/interfaces, reduce manufacturing and ownership costs, and significantly improve R&M.
		CC-02	Standardize connector and wire types to improve testability and logistic support. Keep the number of "different" standard connectors to a minimum. Use the same connector type keyed differently where possible.
		CC-03	Provide clearance around connectors for engagement/disengagement of cables and proper connector orientation under anticipated environmental conditions (e.g., bare hand of 50 percentile male in an enclosed or protected environment and a gloved hand of a 50 percentile male in an open or unprotected environment).
		CC-04	Use quick release cables and locate cables to make removal and replacement easy and to avoid having to remove one cable to gain access to another. Provide adequate space for cables, including sleeving and tie-downs, and adequate service loops for ease of assembly/disassembly

Guidelines by Category (Cont'd)

Category No.	Category Title	Guideline No.	Guideline
2.10	Inherent Testability Design Checklist	CC-05	Orient and space connectors to allow a sufficient grip on the connector for cable or wire extraction without fear of using the wiring or cable for additional leverage.
		CC-06	Label, and where possible color code, each wire in a harness or cable to facilitate tracking from origin to termination. Each wire, cable, and coax-to-connector interface should be provided with a source of identification to aid in trouble shooting, repair, or modification. Marking the cable designer on the cable along with bar codes is also recommended.
		CC-07	Do not manufacture or dress connectors containing more than 25 wires or cables as a single integrated harness. Group the wires or cables into runs of no more than 25 wires or cables each. In addition to making trouble shooting and repair easier, this approach help avoid large bend radii, thereby simplifying routing, packaging, and stowage.
		CC-08	Standardize connector pin assignments for power, ground, and other frequently used signals.
		CC-09	Locate LRU/subsystem critical nodes (and or test points) so they are accessible from a connector to prevent the need for internal LRU probing or access.
		CC-10	Avoid hidden cables. Visually inspecting and tracing all assembly cables rather than having hidden cables (such as behind other cables or even LRUs) allows for a quick system and cable integrity check which aids in overall system integrity and debug. This also implies quick access for manipulative actions.
		CO-01	Design automated systems and programs with provisions to enable "stop test" and "resume" without the need to cycle back or repeat the entire test.
		CO-02	In the event of program loss or hang-up, automated systems and programs should have provisions for reverting to manual test and operation.
		CO-03	Use a test connector to provide test and maintenance bus access to all system and subsystem faults.
		CO-04	Design systems and subsystems so that ATE can be used to access, read, and control internal components in concert with the test or checkout program.
		CO-05	Avoid the need for costly adapters for signal communications between system, subsystems, line replaceable units (LRUs) or Weapon Replaceable Assemblies (WRAs), and ATE.
		ECS-06	All electrical control, sensing, sensor, warning, caution, or signal interface and wiring should be fully BIT compatible.
		EG-01	Design feedback loops so that the loop can be broken during test to ensure that faults do not propagate to the point where they cannot be isolated.
		EG-02	Avoid using external feedback loops requiring complex circuitry to simulate feedback I/Os.
		EG-03	In rare instances when complex external feedback loops cannot be avoided, incorporate simple interruptible control points.
		EG-04	Avoid long sequences of vectors to initialize or alter device outputs to minimize potential testability problems.
		EG-05	Avoid the need to have test equipment generate complex, phased or time related signals.
		EG-06	Test points should be located on all circuit nodes that are useful in determining the module's health.
		EG-07	Test points should be designed so that functional circuitry cannot be damaged or degraded due to the routing or accidental shorting of a signal at a test point. Some type of test point isolation technique should be used (buffers, isolator, etc.).
		EG-08	Test points should be easily accessed and clearly marked.
		EG-10	Design redundant circuits to be independently testable to ensure errors are not masked.
		EG-11	To improve the probability of fault detection, avoid shorting signals together to achieve a specific test function or condition.
		EG-12	Incorporate concept for partitioning module functions to simplify test equipment or eliminate the need for ancillary test equipment.
		EG-13	Design oscillators or clocks that are resident on the module to be replaceable by a signal from a connector to avoid the need to synchronize ATE to on-board signals.

Guidelines by Category (Cont'd)

Category No.	Category Title	Guideline No.	Guideline
2.10	Inherent Testability Design Checklist	ENG(G)-18	Incorporate appropriate sensors to enhance the diagnostic and prognostic capabilities for the following: <ul style="list-style-type: none"> - Fuel filter bypass - Oil pressure - Oil filter bypass - Oil cooler bypass valve position - Oil level - Oil return line particle count
		ENG-01	All facets of engine design should take advantage of Electrostatic Engine Monitoring Systems (EEMS) and Inductive Debris Monitoring (IDM) toward achievement of on-condition maintenance and engine health monitoring.
		ENG-02	Each different component of rotating machinery should contain different tracer elements to enhance EEMS and IDM isolation and tracking of wear.
		ENG-03	Digital electronic controls, fully automatic digital electronic controls, and similar concepts should contain the highest degree of BIT and diagnostics commensurate with affordability, operation and maintenance, and life cycle costs as appropriate.
		ENG-13	Engine oil systems should contain on-board spectrometric oil analysis devices located on the engine.
		ENG-38	The characteristics of engine-to-vehicle interfaces coupled with the capabilities of electronic engine controls, should negate the necessity for making any type of engine rigging including maximum power, idle, and idle cut-off.
		FI-01	Design each FI test to be independent of all other tests.
		FI-02	Design FI initiation to be subordinate to the higher priority predecessor tests.
		FI-03	Design each test so that it can be terminated prior to completion and then re-initiated at its start point.
		FI-04	Design the unit tests so that they can accommodate the following subsystem response modes: <ul style="list-style-type: none"> - Incorrect response - No response - Inconsistent response - Unexpected condition
		FI-05	Design all software so that it is structured by test priority. The test software should take advantage of both subroutine constructs for all message outputs and of failure dictionaries which identify the location of the most likely failed replaceable unit.
		FI-06	In an airborne avionics system, consider indicating mission critical faults on a pilots "head-up" display accompanied with an audible alarm, so that the pilot can easily check for critical system or mission threatening problems.
		FI-07	Ensure that system user manuals include instructions for faults not covered by BIT such as, system will not power up or system is being used in an incorrect environment such as, at the wrong altitude, etc.
		FI-08	Interlock the high power sections of systems and subsystems with visual/audible BIT to ensure safe system activation.
		FI-09	Design BIT to first conduct self-test for circuitry integrity before conducting system test.
		FI-10	Use clear text to report failures rather than alpha-numeric codes, lights, indicators, etc.
		FI-11	Locate BIT circuitry on the same level of the subsystem under test to simplify test and repair when it is removed from the main system.
		HYD-08	Design hydraulic pumps and motors with tracer elements to detect wear through on-board spectrometric oil analysis devices.
		MG-01	Mount LRUs/sub-systems on drawer slides or extender racks to provide easier accessibility during integration, testing, debug, and repair of Units Under Test (UUTs).
		MG-02	Use a modular system design so that each subassembly is designed as a functionally complete entity. Then when a subassembly was removed for testing, ATE will not need custom circuitry to simulate missing functions.
		MG-03	Clearly mark all subsystems/LRUs to make system integration, test, debug, and repair easier.
		MP-01	Avoid the use epoxies to mount parts on repairable modules because they make repair extremely difficult.
		MP-02	Use a unique identification (ID) resistor incorporated in each system module to verify that the proper module is mounted on ATE.

MIL-HDBK-470A

APPENDIX C

Guidelines by Category (Cont'd)

Category No.	Category Title	Guideline No.	Guideline
2.10	Inherent Testability Design Checklist	MP-03	Design modules so that lengthy warm-up times, special coding and air purity levels, and similar constraints are not necessary.
		OXY-01	System should contain automatic BIT for warning indicators to eliminate dedicated test switches and/or test requirements.
		OXY-11	System operational and service condition status should be capable of being downlinked to centralized maintenance facilities.
		PYRO-15	Pylon-to-weapon and pylon-to-air vehicle electrical interfaces should contain built-in test/fault location capabilities.
		TP-01	Locate Input/Output (I/O) test points and associated readouts in close proximity to each other so that one person can perform testing.
		TP-02	Protect test points against the environment and from induced contamination.
		TP-03	Protect test points from outside signal generation.
		WBAY-21	Coatings and finishes in the area of gun barrels should be durable to withstand the effect of exiting projectile shockwaves.
		WBAY-22	The proximity of the gun blast deflector to structure should not require reliance on high-temperature paints or coatings to protect the structure.
		WT&B-07	Landing gear caution and warning systems should contain both initiated and periodic BIT and be capable of fault-isolating to each component in the system.
		WT&B-15	Anti-skid and anti-lock brake systems should contain periodic and initiated BIT. All components, including speed sensors, comparators, wiring, connectors, control boxes, etc., should be included in the BIT system.
2.11	Preventive Maintenance	A-09	Any heat or temperature sensitive structure within a compartment should contain heat-sensitive tape or appropriate heat sensor for easy indication of over-temperature excursions.
		A-16	Structural design should provide good access to corrosion-prone areas for inspection and treatment.
		A-17	All structural fasteners in an access door or panel should be of identical grip and diameter. In rare cases where this is not possible, fasteners of different grip must have different diameters to prevent a shorter fastener being substituted for the correct, longer fastener.
		A-18	Use transparent windows, quick-opening covers, or openings without any cover to permit quick visual inspections where needed.
		ACS-06	Do not try to achieve high reliability by requiring frequent visual inspections or scheduled replacement at predetermined calendar or operating hour intervals.
		BIT-05	Incorporate testability design features as an integral part of equipment preliminary design process.
		C-01	Avoid swivel type connectors and fittings for air, fuel, or hydraulic line interfaces due to their history of low reliability.
		C-02	Provide spacing between parallel plumbing runs so that in-line couplings can be replaced without removing lines or disconnecting any line support devices.
		CONT-01	Control rods should use Boyd or impedance type bolts (or equivalent) to eliminate the need for cotter pins or safety wire.
		CREW-04	Avoid wiring, coax, and plumbing penetrations through the floor of crew cabs, operators' compartments, crew stations, cockpits, and passenger compartments.
		CREW-05	Structural instrument panels, dashboards, and control panels should be modularized for easy and adequate access to all interfaces, to simplify manufacturing, and to reduce maintenance-induced problems.
		D&V-01	The geometric aspects of structural design and interfaces should not result in any natural bathtubs.
		D&V-02	Closed structural sections subject to condensation or fluid migration should contain drainage provisions.
		D&V-03	Crew cabs, operators' compartments, crew stations, cockpits, and passenger compartments should be subject to the same corrosion prevention measures as the exteriors of the vehicles. Low points, pockets, and related fluid collection points within should be provided with low point drains.
		EC-06	All electrical connectors should be corrosion resistant to reduce or eliminate the need for scheduled inspections or corrosion prevention measures.
		EC-07	Avoid using electrical connectors requiring any type or form of soldering.
		EC-08	Locate and position electrical connectors such that all pin identification for either half can be easily seen.

Guidelines by Category (Cont'd)

Category No.	Category Title	Guideline No.	Guideline
2.11	Preventive Maintenance		
		EC-11	Avoid connectors requiring potting as a method for environmental protection due to lengthy repair time and tendency for potting compound reversion.
		EC-15	The removal or replacement of electronic equipment should not require the removal of any other piece of equipment or armament.
		ECS-01	Design so that equipment servicing status are accessible and readable from the ground level for air vehicles and from the operator's position for ground and water vehicles.
		ECS-21	Do not locate ground cooling or circulation fans that operate at high noise levels in operator, crew, or passenger compartments.
		ENG(G)-16	Do not locate batteries in the engine compartment. In those instances where this is not possible: - The battery support structure should be of a material that is impervious to acid leakage or boil-over.
		ENG(G)-18	The battery support structure should serve as a sump to collect and direct the acid out of the engine compartment Incorporate appropriate sensors to enhance the diagnostic and prognostic capabilities for the following: - Oil temperature - Fuel filter bypass - Oil pressure - Coolant pressure - Oil filter bypass - Coolant level - Oil cooler bypass valve position - Coolant temperature - Oil level - Vibration pickups - Oil return line particle count - Chip detector
		ENG(G)-19	Paint engine compartments gloss white to enhance light reflectivity and enhance fluid leak detection.
		ENG-01	All facets of engine design should take advantage of Electrostatic Engine Monitoring Systems (EEMS) and Inductive Debris Monitoring (IDM) toward achievement of on-condition maintenance and engine health monitoring.
		ENG-02	Each different component of rotating machinery should contain different tracer elements to enhance EEMS and IDM isolation and tracking of wear.
		ENG-03	Digital electronic controls, fully automatic digital electronic controls, and similar concepts should contain the highest degree of BIT and diagnostics commensurate with affordability, operation and maintenance, and life cycle costs as appropriate.
		ENG-06	All other engine surfaces and engine-mounted accessory surfaces should be free of pockets, channels, and bathtubs that could trap and retain fluids.
		ENG-13	Engine oil systems should contain on-board spectrometric oil analysis devices located on the engine.
		ENG-20	Do not locate equipment or components in the engine cavity except for those components associated with the engine or engine installation.
		ENG-21	Do not locate equipment or components in the engine bay cavity in a manner that would require removal or repositioning for engine removal.
		ENG-23	All engine borescope provisions should be accessible with the engine installed and hooked up.
		ENG-35	No time-change components or scheduled actions should be planned solely to protect component integrity or reliability.
		ENG-36	All borescope mechanisms should have positive integral locking features.
		ENG-38	The characteristics of engine-to-vehicle interfaces coupled with the capabilities of electronic engine controls, should negate the necessity for making any type of engine rigging including maximum power, idle, and idle cut-off.
		ENG-49	Design engine fuel and oil filters with integral locking features so they can be installed and removed by hand, and require no torquing.
		ENG-50	Design engine fuel and oil filter delta pressure indicators so they can be reset only from within the filter housing.
		ENG-51	Provide engine fuel and oil filters with anti-surge protection to ensure false delta pressure indications do not occur.
		ENG-52	Incorporate provisions to enable very slow rotation of the fan, compressor, and turbine during borescope inspections.
		ENG-53	Design magnetic chip detectors to ensure that oil shut-off will occur as the detector is being removed for visual inspection.
		ENG-54	Incorporate provisions for fuzz burn-off, in magnetic chip detectors.

Guidelines by Category (Cont'd)

Category No.	Category Title	Guideline No.	Guideline
2.11	Preventive Maintenance	ENV-01	Materials, treatments, coatings, finishes should be compatible with all anti-ice and de-ice fluids, chemical and biological decontamination fluids, washing and cleaning fluids, and all vehicle subsystem fluids.
		ENV-02	There should be no top coat or treatment deterioration throughout the standard temperature and humidity spectrum.
		ENV-03	For airborne vehicles, the finishes should be durable against rain, hail, and dynamic erosion throughout the flight envelope.
		ENV-04	For airborne and ground vehicles, the finishes should be durable against sand erosion throughout all surface wind speeds experienced in arid or desert geographical locations.
		ENV-05	For airborne vehicles, materials and all finishes with the engine inlet should be durable against hammer shock and compressor stalls.
		ENV-06	For ground vehicles, the finishes should be compatible with and durable against all rain, hail, sleet, snow, and ice conditions experienced in all intended operational environments.
		ENV-07	The finishes and surfaces should be capable of low velocity impact (LVI) of 10 foot-pounds with no visual or detectable damage with a design goal of 30 foot-pounds.
		EXH-01	Treatments required for engine hot sections and exhaust areas should not require scheduled removals for the purposes of recoating.
		EXH-02	High temperature exhaust patterns should flow away from or be directed away from treated surrounding structure, coatings, or finishes.
		HYD-08	Design hydraulic pumps and motors with tracer elements to detect wear through on-board spectrometric oil analysis devices.
		HYD-11	Design flexible hose with molded-in color bands to clearly indicate when the maximum wear/abrasion has been reached.
		IN-01	Low Observable (LO) engine face frames should be within 10 inches of the first stage fan or compressor blades.
		IN-02	Openings throughout the engine face frame should be sufficient to perform a 100% FOD inspection of the engine face.
		IN-03	Openings throughout the engine face frame should be sufficient to permit minor blending or repair of FOD without removing the engine.
		IN-04	For frames not integral with the engine, frame removal should be achievable from the engine cavity.
		IN-05	Both integral and remote engine front frames should be interchangeable.
		IN-06	Front frame anti-ice and de-ice provisions should give preference to engine hot bleed air.
		LG-01	Bearings, excluding wheel bearings, should not require lubrication during the expected life of the air vehicle airframe.
		LG-04	Do not use Beryllium and Beryllium base alloys in any location subject to wear or corrosive atmospheres or in installations where machining may be required.
		LG-06	Design struts, attachments, and interfaces so they do not depend on scheduled visual inspections, non-destructive inspection (NDI), or non-destructive test (NDT) to ensure the reliability or integrity of the system in the operational environment.
		LG-07	No portion of the landing gear struts, drag braces, or interfaces should contain pockets or bathtubs that can trap or hold moisture. In rare instances where this is not possible, holes should be drilled as appropriate to prevent moisture/liquid accumulation.
		LG-15	No portion of the landing gear closure door(s) should be attached to the strut. In rare instances where this may not be possible, that attached portion should not require alignment or rigging.
		LG-26	Gravitational emergency extension of landing gear should be given preference over all other concepts.
		LG-29	Basic gear design combined with manufacturing tolerances should ensure that no uplock or downlock rigging is required.
		LO-02	Avoid scheduled forced inspections or replacement of materials, coatings, or finishes solely to protect either the reliability or the signature.
		OXY-01	System should contain automatic BIT for warning indicators to eliminate dedicated test switches and/or test requirements.
		OXY-03	Provide condition sensors for oxygen concentrators to eliminate periodic and/or forced replacement.
		OXY-11	System operational and service condition status should be capable of being downlinked to centralized maintenance facilities.

Guidelines by Category (Cont'd)

Category No.	Category Title	Guideline No.	Guideline
2.11	Preventive Maintenance		
		P-04	Door and panel seals should be compatible with all types of on-board servicing fluids, de-ice and anti-ice fluids, and all fluids used for chemical, biological, and nuclear decontamination.
		P-05	Piano type hinges should not be used on doors or panels because they are subject to wear, corrosion, and sand and fluid entry.
		PYRO-12	Design of weapons, flare/chaff packages, and airborne pyrotechnic containers should follow the "wooden round" design concept to eliminate scheduled tests, checks, and inspections throughout its intended life cycle.
		PYRO-16	Do not use cartridge actuated devices (CADs) for store or weapon ejection or for pylon jettison due to inherent ground safety hazards, stray energy hazards, and scheduled cleaning requirements.
		SABCH-13	No structural design concept should rely on frequent scheduled inspections to monitor or otherwise ensure structural integrity.
		SE-07	The design construction concept and material selection for support equipment structure should not rely or depend upon the use of scheduled maintenance, NDI, or NDT to protect the durability or integrity of the equipment in the operational environment.
		SEAT-01	Design personnel seats and padding materials, including the covers and fillers, so they are incapable of creating or emitting toxic fumes or dense smoke when subjected to fire.
		SEAT-02	Design personnel seats and padding materials so they are incapable of absorbing and holding fluids.
		SEAT-06	Do not use seat removal as a means of access.
		SKID-04	Design pneumatic floats with an integral air gage located adjacent to the air fill fitting.
		SURV-03	Survival gear containerization or storage should have a minimum twelve-month period between scheduled tests, checks, or replacements.
		TCR-01	For each transmission, clutch, or rotor, provide a dedicated lubricating oil supply tank and system that is not shared with any other oil lubricating system.
		TCR-02	Provide each dedicated oil supply system with a separate servicing port/interface, pressure gauging, and quantity gauging system as applicable.
		TCR-03	Use a singular gage capable of reading pressures or quantities from two or more lubricating systems in preference to individual gages.
		TCR-04	Provide each dedicated system with an on-board spectrometric oil analysis program capability, separate oil filter, and separate oil, fuel, or air heat exchanger capability.
		TCR-05	Use the item's self-contained oil system to provide drive/interface spline lubrication, if required.
		TCR-06	In complex units, use different tracer elements in multiple gears, plates, discs, etc., so the source of wear can be easily identified by spectrometric oil analysis monitoring units.
		TCR-07	Design mechanical interfaces to transmissions, clutches, and rotors so that the respective unit can be replaced without the need for rigging.
		TCR-08	Incorporate vibration pick-up sensors to isolate the respective unit from other potential sources of vibration, and to enhance the prognostic potential for monitoring equipment health.
		WBAY-20	Gun plugs required solely to maintain a given signature level should be capable of on-board stowage for use only when a threat requires their presence.
		WIND-01	Optical window materials should be scratch resistant, easy to clean, and dissipate electrostatic charges.
		WIND-02	Optic windows should be located for ease of inspection, cleaning, and induced damage potential from personnel or support equipment.
		WIND-03	Window locations should minimize the effects of contamination by salt spray, bugs, oils, fuels, and icing.
		WIND-04	Window, canopy, and windshield material should be designed to withstand the effects of sandstorms in the ground environment and the effects of rain and hail during thunderstorm penetration in the airborne environment.
		WIND-05	Design interior surfaces to be reachable for cleaning without reliance on hinging, equipment removal, or use of support equipment.
		WIND-06	Do not locate windows in the proximity of rooster tails created by wheels/tires passing through water or slush.

MIL-HDBK-470A

APPENDIX C

Guidelines by Category (Cont'd)

Category No.	Category Title	Guideline No.	Guideline
2.11	Preventive Maintenance	WIND-11	For dome-shaped optic window concepts, the dome should be easily removable for cleaning without affecting LO integrity.
2.11.1	Environmental Factors	WT&B-14 A-01	Wheel assemblies should contain built-in dial type pressure gages. Seal equipment bays and compartments against the environmental elements including all types of servicing fluids used for the vehicle, all types of anti-ice and de-ice fluids, and all types of fluids used for chemical, biological, or nuclear decontamination
		A-09	Any heat or temperature sensitive structure within a compartment should contain heat-sensitive tape or appropriate heat sensor for easy indication of over-temperature excursions.
		A-11	Locate compartment electrical penetrations close to the access opening for ease of sight, probing, repair, and to eliminate fluid soaking, wicking, or contamination.
		A-12	Locate compartment electrical penetrations far enough from the access opening to prevent damage resulting from improper (over-length) panel fasteners.
		A-16 A-18	Structural design should provide good access to corrosion-prone areas for inspection and treatment. Use transparent windows, quick-opening covers, or openings without any cover to permit quick visual inspections where needed.
		AA&S-02	Closure and sealing of cavities, compartments, and wells for retractable antennas should be mechanized to function as part of the extend and retract cycle.
		AA&S-03	Closure and sealing of cavities, compartments, and wells for retractable antennas should be maintained when antennas are not installed without need for ancillary measures or equipment.
		AA&S-04	LO antennas should be designed to be tolerant of accumulations of grime or dirt without degrading performance or biasing the BIT/fault isolate performance.
		ACS-01	Design air cushion skirt surfaces to be highly resistant to high velocity blowing sand and stones.
		ACS-02	Design skirt surfaces to the same operational and environmental criteria as that identified for low observable surfaces.
		ACS-07	Design skirt repair kits and select materials for the kits so they are not subject to a predetermined shelf-life or special storage requirements.
		ARM-13	Do not locate magnesium fittings or structure in the motor plume of rail-launched missiles.
		CBR-01	Orient all vehicle liquid servicing fittings to ensure fluids will not come in contact with protective garb during connect/disconnect activities.
		CBR-02	Ensure vehicle overboard passive liquid drains are clearly marked or visible to enable personnel to remain clear of area.
		CBR-03	Design fuel cell drains so they can not be activated in a manner that would allow fuel to come in contact with a protected hand.
		CBR-04	Design emergency ingress provisions so they can be activated by a 95 percentile male wearing full protective chemical or biological protection gear.
		CBR-05	Size rescue doors, panels, and "cut here" areas to accommodate the 95 percentile shoulder width wearing full protective chemical or biological protection gear.
		CBR-06	Consider the reduction in peripheral vision resulting from wearing chemical or biological protection gear when designing intended fire paths and crash rescue paths into a vehicle.
		CC-11	Orient spare wires and cable pigtails along the outer diameter or periphery of connectors to make access easier.
		CC-12	Build up and assemble straight and angle connector shells or back shells in a manner that ensures that wire or cable strain or wear is not possible.
		CONT-02	Do not use metal control cables for vehicles that will operate in salt water or salt air environments.
		D&V-01	The geometric aspects of structural design and interfaces should not result in any natural bathtubs.
		D&V-02	Closed structural sections subject to condensation or fluid migration should contain drainage provisions.
		D&V-03	Crew cabs, operators' compartments, crew stations, cockpits, and passenger compartments should be subject to the same corrosion prevention measures as the exteriors of the vehicles. Low points, pockets, and related fluid collection points within should be provided with low point drains.

Guidelines by Category (Cont'd)

Category No.	Category Title	Guideline No.	Guideline
2.11.1	Environmental Factors		
		EC-06	All electrical connectors should be corrosion resistant to reduce or eliminate the need for scheduled inspections or corrosion prevention measures.
		EC-07	Avoid using electrical connectors requiring any type or form of soldering.
		EC-08	Locate and position electrical connectors such that all pin identification for either half can be easily seen.
		EC-11	Avoid connectors requiring potting as a method for environmental protection due to lengthy repair time and tendency for potting compound reversion.
		EC-12	Electrical penetrations into a compartment should not be on a vertical axis to ensure foreign matter does not enter connector.
		EC-18	All electric connectors should be environment resistant.
		EC-20	Use quick disconnect connectors where allowed and identify all pins on each connector.
		ECS-12	Design air inlets, outlets, and exhausts with screens to prevent bird or rodent entry.
		ECS-14	Instances where air inlets, outlets, and exhausts are subject to water entry, passive drains should be employed capable of handling 4" of rain per hour.
		ECS-18	Avoid the use of insulation blankets containing polyvinyl for any application due to the dense smoke and toxic fumes if burned or subjected to high temperature bleed air leakage.
		ECS-27	Use temperature-limiting devices with high temperature air systems to ensure no single or combination of surface wind, cross wind, ground operation or flight operation will damage windshields, canopies, windows or optics.
		EDECOM-01	Provide surface sensors on equipment located in compartments containing louvers, screens, flush inlets, or similar openings to the environment to indicate the presence of chem/bio contaminants.
		EDECOM-02	Provide integral sensors (viewable from the exterior) for equipment subject to internal forced-air cooling from outside or external air to indicate the presence of contaminants.
		EDECOM-03	Design equipment surfaces and structure to be compatible with all decontamination agents and methods.
		EDECOM-04	Provide passive overboard drains in compartments subject to decontamination processes to void the area of contaminants.
		EDECOM-05	Provide hoist, lift or transport handles for equipment requiring removal from the host vehicle for decontamination. In instances where this may not be practical, design the equipment with hardpoints for attaching parasitic carrying provisions
		ENG(G)-01	Provide access to all engine mounts for ground vehicles so that hoisting or crawling under the vehicle is not required.
		ENG(G)-16	Do not locate batteries in the engine compartment. In those instances where this is not possible: - The battery support structure should be of a material that is impervious to acid leakage or boil-over. - The battery support structure should serve as a scupper to collect and direct the acid out of the engine compartment.
		ENG-06	All other engine surfaces and engine-mounted accessory surfaces should be free of pockets, channels, and bathtubs that could trap and retain fluids.
		ENG-46	Design the basic engine and engine-mounted accessory interface so that no fluid traps or bathtubs exist regardless of engine-mounted accessory location.
		ENG-47	Design the engine, including all accessories, plumbing, wiring, ducts, and mechanisms, to meet the same environmental protection and compatibility requirements as the host vehicle.
		ENG-48	Do not drain or dump residual fuel in the engine fuel control/manifold overboard. When it is not possible to follow this guideline, route the fuel to an engine-mounted collector tank capable of retaining fuel from two shutdowns.
		ENV-01	Materials, treatments, coatings, finishes should be compatible with all anti-ice and de-ice fluids, chemical and biological decontamination fluids, washing and cleaning fluids, and all vehicle subsystem fluids.
		ENV-02	There should be no top coat or treatment deterioration throughout the standard temperature and humidity spectrum.
		ENV-03	For airborne vehicles, the finishes should be durable against rain, hail, and dynamic erosion throughout the flight envelope.
		ENV-04	For airborne and ground vehicles, the finishes should be durable against sand erosion throughout all surface wind speeds experienced in arid or desert geographical locations.
		ENV-05	For airborne vehicles, materials and all finishes with the engine inlet should be durable against hammer shock and compressor stalls.

MIL-HDBK-470A

APPENDIX C

Guidelines by Category (Cont'd)

Category No.	Category Title	Guideline No.	Guideline
2.11.1	Environmental Factors		
		EXH-01	Treatments required for engine hot sections and exhaust areas should not require scheduled removals for the purposes of recoating.
		EXH-02	High temperature exhaust patterns should flow away from or be directed away from treated surrounding structure, coatings, or finishes.
		EXTING-01	Use extinguishing concepts dedicated to each individual fire zone in preference to manifold systems operating from a central source.
		FUEL-01	Locate fuel vent and dump masts to ensure exiting fuel will be clear of servicing, loading, arming and safing areas for all types of ground and airborne vehicles.
		HYD-05	Design protective caps or covers over service fittings with steel cable lanyards to prevent loss and migration in the vehicle.
		IN-06	Front frame anti-ice and de-ice provisions should give preference to engine hot bleed air.
		LG-01	Bearings, excluding wheel bearings, should not require lubrication during the expected life of the air vehicle airframe.
		LG-04	Do not use Beryllium and Beryllium base alloys in any location subject to wear or corrosive atmospheres or in installations where machining may be required.
		LG-07	No portion of the landing gear struts, drag braces, or interfaces should contain pockets or bathubs that can trap or hold moisture. In rare instances where this is not possible, holes should be drilled as appropriate to prevent moisture/liquid accumulation.
		LG-11	All microswitches, proximity switches, lights, sensors, etc. mounted to a strut should have individual interface connectors. Wiring pigtaills requiring in-line splices should be avoided.
		LG-21	Proximity type switches used in landing gear design should meet a minimum of 200 volt-amperes to eliminate Electromagnetic Interference (EMI) or Radiation Hazard (RADHAD) problems. Wiring associated with the landing gear design should meet the same requirements.
		LG-30	Do not use landing gear wells to locate any type of auxiliary air inlet.
		LO-01	Use LO compatible gap fillers for manufactured gaps in lieu of tape and butter (surface coating compound).
		LO-02	Avoid scheduled forced inspections or replacement of materials, coatings, or finishes solely to protect either the reliability or the signature.
		LO-03	Equipment and support structure requiring shrouds to reduce radar returns should not cause increases in equipment service/repair time.
		LO-06	Size flush mounted LO screens for auxiliary air inlets and exits to ensure functionality with up to 25 percent of the openings plugged.
		LO-07	Flush and non-flush LO screens should be interchangeable.
		MATL-02	Cosmetic type repairs should not exceed 1 hour including cure or drying times.
		MATL-03	Cosmetic and vehicle repair material shelf life should not be less than 24 months.
		MATL-05	Cosmetic and vehicle repair materials should not require refrigeration or special facilities or atmospheres for storage.
		MATL-07	All cosmetic touch-up and repair materials should be environmentally safe.
		MATL-08	Repairs (other than major depot repair) should not require autoclave type facilities.
		MATL-09	A high degree of durability should be achieved across all walkway areas on the top surfaces of all vehicles up to and including 95 percentile personnel.
		MATL-10	Coatings and finishes should be durable against the effects of missile gases, velocities, and particles emanating from the missile motor.
		MATL-11	Coatings and finishes should be durable against the effects of gun gases, projectile shock waves, and brass particles emanating from the projectile seal rings.
		MATL-12	Leading edge materials and coatings should be durable against fragments from frangible gun port plugs.
		MP-03	Design modules so that lengthy warm-up times, special coding and air purity levels, and similar constraints are not necessary.
		OXY-02	Provide sensors to denote occurrence of On-Board Oxygen Generating Systems (OBOGS) bleed air over temperature.

Guidelines by Category (Cont'd)

Category No.	Category Title	Guideline No.	Guideline
2.11.1	Environmental Factors		
		P-03	All doors and panels subject to environmental elements should contain form-in-place seals (or equivalent) attached to the door structure, not substructure, to prevent damage during maintenance.
		P-04	Door and panel seals should be compatible with all types of on-board servicing fluids, de-ice and anti-ice fluids, and all fluids used for chemical, biological, and nuclear decontamination.
		P-05	Piano type hinges should not be used on doors or panels because they are subject to wear, corrosion, and sand and fluid entry.
		PYRO-07	Manual "safe/arm" mechanisms should be well-clear of inlet ducts, propellers, rotors, and similar rotating components.
		PYRO-13	Container design for shipping, handling, and storing weapons, flares, chaff, and similar devices should not require special atmospheres.
		PYRO-26	Do not locate ammunition loader interfaces close to inlets, exhausts, fuel dumps and drains, antennas, sensors, lights, or hazardous protrusions.
		PYRO-34	Weapon bay door seals should be bonded or attached to door structure to minimize induced seal damage during weapon or store loading.
		SAFE-03	Stored energy devices (e.g., accumulators, nitrogen bottles, gas generators, etc.), that could cause injury, harm, or damage if inadvertently actuated, should contain integral safing provisions.
		SE-02	Wheel chocks for airborne vehicles should also contain the following features: <ul style="list-style-type: none"> - Contain provisions for securing to ramp or flight decks - Contain provisions to secure chocks at wheels - Releasable/removable from outside of hot brake envelope - Contain provisions to enable chock to be used as a tire blowout device - Contain provisions to prevent skidding on snow or ice
		SE-03	Wheel chock design guideline discussion. Wheel chocks have historically contributed to numerous accidents and incidents across the entire design spectrum, yet have received the least design attention of any ground handling/support equipment. Directly and indirectly, poorly designed chocks have: <ul style="list-style-type: none"> - Resulted in numerous "jumping the chocks" incidents due to improper use or positioning, and improper chock sizing for the tire size/power application. Some instances result in destruction of the aircraft. - Resulted in vehicle movement/sliding across wet, snowy and icy surfaces as a result of improper grip. - Resulted in unwarranted tire damage and/or engine FOD. - Resulted in tertiary damage to other vehicles or ground equipment as a result of being blown about by jet/propeller blast. - Damaged surfaces due to temporary placement of chocks on vehicle surfaces during vehicle movement. - Resulted in personnel sliver/s abrasions (wooden chocks) and cuts (metal chocks) even when chocks were in decent useable condition. - Resulted in varied personnel ground accidents during attempts to use chocks as a temporary work stand. - Lost aircraft "over the side" on carriers.
		SE-04	Gun port covers or plugs should be lightweight, 100% effective, and easy to install or store.
		SE-08	Support legs, posts, arms for ladders and workstands should contain integral non-skid devices for safe use on ice or snow.
		SEAT-01	Design personnel seats and padding materials, including the covers and fillers, so they are incapable of creating or emitting toxic fumes or dense smoke when subjected to fire.
		SEAT-02	Design personnel seats and padding materials so they are incapable of absorbing and holding fluids.
		SIMP-01	Location and design of all exterior lights should not require protective covers in ground environments.
		SIMP-02	Landing and taxi lights should be mounted on landing gear struts or doors to eliminate separate compartments, doors, and retraction/extension mechanisms.
		SKID-01	Design non-metallic floats to be impervious to all fluids used on board the host vehicle.
		SKID-02	Design non-metallic floats to be highly resistant to scuffing and abrasion.
		SKID-03	Design non-metallic floats with a color-coded inner ply to readily denote when maximum abrasion limits have been reached.
		SKID-05	Design metallic and composite floats and skids to the same environmental criteria as the airframe, including finishes.

Guidelines by Category (Cont'd)

Category No.	Category Title	Guideline No.	Guideline
2.11.1	Environmental Factors	SKID-07	Design floats with simple drain provisions for each compartment.
		T-04	Provide protective closure provisions for PGA exits located or oriented to exposure from the elements.
		WBAY-03	The method and position of the pylon-to-wing gap seal should not form a drip edge for leakage into the pylon cavity.
		WBAY-04	The gap treatment should be a permanent installation on the pylon, wing, or both, not a separate seal.
		WBAY-05	Gap treatment should not interfere with or be damaged by existing pylon handling support equipment.
		WBAY-06	Pylon rigging should not be required for gap seal control.
		WBAY-07	Gap seal should not degrade interchangeability of pylon.
		WBAY-08	Gap seal and treatment should be fully compatible with steam from carrier catapults.
		WBAY-09	Gap seal/pylon should not cover or hamper access to low point wing drains.
		WBAY-10	No loose hardware should exist before or after pylon is installed.
		WBAY-11	Gap seal should match pylon and wing/fuselage surface impedance.
		WBAY-12	Pylon-to-store/weapon gap seal should permit visual and physical access during loading for all interfaces between bomb rack-to-store, bomb rack-to-launcher, and launcher-to-store.
		WBAY-13	Pylon-to-store/weapon gap seal should not interfere with automatic sway brace function.
		WBAY-14	Pylon-to-store/weapon gap seal should permit physical access to lanyards.
		WBAY-15	Gap seals should not hinder pilot or ground crew preflight inspection.
		WBAY-16	Gap seals should not degrade loading while wearing arctic or chemical, biological, or radiation protective clothing.
		WBAY-17	Special coatings or conductive paints on pylons, launchers, racks, launchers, tanks, pods, etc. should have the durability to withstand contact with support stands/cradles during storage.
WBAY-18	The proximity of the gun firing barrel to structure should be such that structural furrows or channels are not required for projectile clearances during firing.		
WBAY-21	Coatings and finishes in the area of gun barrels should be durable to withstand the effect of exiting projectile shockwaves.		
WBAY-22	The proximity of the gun blast deflector to structure should not require reliance on high-temperature paints or coatings to protect the structure.		
WIND-01	Optical window materials should be scratch resistant, easy to clean, and dissipate electrostatic charges.		
WIND-02	Optic windows should be located for ease of inspection, cleaning, and induced damage potential from personnel or support equipment.		
WIND-03	Window locations should minimize the effects of contamination by salt spray, bugs, oils, fuels, and icing.		
WIND-04	Window, canopy, and windshield material should be designed to withstand the effects of sandstorms in the ground environment and the effects of rain and hail during thunderstorm penetration in the airborne environment.		
WIND-05	Design interior surfaces to be reachable for cleaning without reliance on hinging, equipment removal, or use of support equipment.		
WIND-07	Use materials that are highly resistive to thermal shock.		
WT&B-06	Locate brake anti-skid system components, including brake control valves, for easy access in low-vibration environments.		
WT&B-16	Do not use potting compounds for electrical connector environmental protection because it tends to revert and significantly increases repair time.		
WT&B-17	Electrical connector environmental protection should be capable of withstanding water pressure streams up to 120 psi encountered during decontamination, wash, etc.		
A-07	Paint equipment bay and compartment interiors a high gloss white to maximize lighting reflectivity, visibility, and rapid leak detection capability.		
A-10	Provide a sufficient number of compartment fluid drains to ensure fluid drainage for varying aircraft static attitudes and varying terrain slopes for ground vehicles.		
A-11	Locate compartment electrical penetrations close to the access opening for ease of sight, probing, repair, and to eliminate fluid soaking, wicking, or contamination.		
3.01	Connections		

Guidelines by Category (Cont'd)

Category No.	Category Title	Guideline No.	Guideline
3.01	Connections	A-12	Locate compartment electrical penetrations far enough from the access opening to prevent damage resulting from improper (over-length) panel fasteners.
		A-13	Two-sided or two-surfaced access should not be required for access to equipment interfaces and hardpoints. The term two-sided infers top/bottom, left/right, front/back, or combinations thereof.
		A-14	Do not locate nutplates or gang channels in inaccessible areas that would require extensive disassembly or equipment removal to gain access.
		A-15	Locate tie-down attachment points such that tie-down chains, straps, or cables do not prevent or restrict normal servicing, weapon loading, or safe/arm functions.
		BIT-05	Incorporate testability design features as an integral part of equipment preliminary design process.
		BIT-06	Mission critical functions should be monitored by BIT.
		BIT-09	Use concurrent BIT to monitor system critical functions.
		BIT/BITE-02	Design EMI protection to eliminate finger type EMI contact devices.
		C-01	Avoid swivel type connectors and fittings for air, fuel, or hydraulic line interfaces due to their history of low reliability.
		C-02	Provide spacing between parallel plumbing runs so that in-line couplings can be replaced without removing lines or disconnecting any line support devices.
		CBR-01	Orient all vehicle liquid servicing fittings to ensure fluids will not come in contact with protective garb during connect/disconnect activities.
		CC-01	Use fiber-optic technologies in preference to conventional interconnect concepts to reduce the number of interconnects/interfaces, reduce manufacturing and ownership costs, and significantly improve R&M.
		CC-02	Standardize connector and wire types to improve testability and logistic support. Keep the number of "different" standard connectors to a minimum. Use the same connector type keyed differently where possible.
		CC-03	Provide clearance around connectors for engagement/disengagement of cables and proper connector orientation under anticipated environmental conditions (e.g., bare hand of 50 percentile male in an enclosed or protected environment and a gloved hand of a 50 percentile male in an open or unprotected environment).
		CC-04	Use quick release cables and locate cables to make removal and replacement easy and to avoid having to remove one cable to gain access to another. Provide adequate space for cables, including sleeving and tie-downs, and adequate service loops for ease of assembly/disassembly.
		CC-05	Orient and space connectors to allow a sufficient grip on the connector for cable or wire extraction without fear of using the wiring or cable for additional leverage.
		CC-06	Label, and where possible color code, each wire in a harness or cable to facilitate tracking from origin to termination. Each wire, cable, and coax-to-connector interface should be provided with a source of identification to aid in trouble shooting, repair, or modification. Marking the cable designator on the cable along with bar codes is also recommended.
		CC-07	Do not manufacture or dress connectors containing more than 25 wires or cables as a single integrated harness. Group the wires or cables into runs of no more than 25 wires or cables each. In addition to making trouble shooting and repair easier, this approach help avoid large bend radii, thereby simplifying routing, packaging, and stowage.
		CC-08	Standardize connector pin assignments for power, ground, and other frequently used signals.
		CC-09	Locate LRU/subsystem critical nodes (and or test points) so they are accessible from a connector to prevent the need for internal LRU probing or access.
		CC-10	Avoid hidden cables. Visually inspecting and tracing all assembly cables rather than having hidden cables (such as behind other cables or even LRUs) allows for a quick system and cable integrity check which aids in overall system integrity and debug. This also implies quick access for manipulative actions.
		CONT-01	Control rods should use Boyd or impedance type bolts (or equivalent) to eliminate the need for cotter pins or safety wire.
		CONT-02	Do not use metal control cables for vehicles that will operate in salt water or salt air environments.
		CONT-03	Use control rods rather than control cables for non-complex applications and non-complex routing within the vehicle.
		CONT-04	Use control cables rather than control rods for most complex applications.
		CONT-05	Route cables so that 100 percent of a cable will be viewable for inspection.

Guidelines by Category (Cont'd)

Category No.	Category Title	Guideline No.	Guideline
3.01	Connections		
		CONT-06	Design all pulleys and brackets associated with cable installations so they are accessible by a 75 percentile male hand.
		CREW-04	A void wiring, coax, and plumbing penetrations through the floor of crew cabs, operators' compartments, crew stations, cockpits, and passenger compartments.
		EC-01	A threaded electrical connector should contain integral locking mechanisms and visual indications that the connector is properly seated and locked.
		EC-02	An electrical connector requiring less than one full turn to connect or disconnect should contain integral locking mechanisms and visual indications that the connector is properly seated and locked.
		EC-03	A push-pull electrical connector (excluding rack-and-panel type) should contain integral locking features and visual indication that the connector is properly seated and locked.
		EC-04	All electrical connectors should be keyed or asymmetrically shaped to ensure proper alignment.
		EC-05	All electrical connectors should contain scoop-proof shells to ensure pin damage will not occur prior to engaging key way.
		EC-06	All electrical connectors should be corrosion resistant to reduce or eliminate the need for scheduled inspections or corrosion prevention measures.
		EC-07	Avoid using electrical connectors requiring any type or form of soldering.
		EC-08	Locate and position electrical connectors such that all pin identification for either half can be easily seen.
		EC-09	Electrical connectors selected for critical applications on ground vehicles should be both accessible and capable of being connected disconnected by a fifty percentile gloved male hand.
		EC-10	Separation between grouped electrical connectors should be sufficient to ensure make or break of any connector by a fifty percentile gloved male hand. Where this is not possible, an alternate method should be used such as the use of stand-offs, long-shelled connectors alternated with standard connectors, 180-degree connectors alternated with 90-degree connectors, or innovative equivalents.
		EC-11	Avoid connectors requiring potting as a method for environmental protection due to lengthy repair time and tendency for potting compound reversion.
		EC-12	Electrical penetrations into a compartment should not be on a vertical axis to ensure foreign matter does not enter connector.
		EC-13	Electrical, electronic, and coaxial interfaces between fixed and moveable surfaces should contain quick disconnects to simplify replacement of the moveable surface or the electronic module.
		EC-14	Scoop proof connectors should be used throughout unless their use would require an increase in the volume of the aircraft, in which case deviations will be considered on an individual basis.
		EC-15	The removal or replacement of electronic equipment should not require the removal of any other piece of equipment or armament.
		EC-16	Select connectors so that contacts on the "live" or "hot" side of the connection are socket type rather than pin type to minimize personnel hazard and to prevent accidental shorting of live circuits.
		EC-17	Whenever possible, use self-locking connector plugs of a type not requiring safety wire.
		EC-18	All electric connectors should be environment resistant.
		EC-19	Connectors containing fiber optic contacts should, whenever possible, be mounted on a vertical surface to prevent particle and fluid contamination.
		EC-20	Use quick disconnect connectors where allowed and identify all pins on each connector.
		EC-21	Locate connectors far enough apart so that they meet specified requirements.
		EC-22	All connectors should be keyed differently with aligning pins that extend beyond the electrical pins. Connector pins and sockets should engage after key position is entered.
		EC-23	Design connectors so that plugs are cold and receptacles are hot.
		EC-24	Use electrical connectors that incorporate alignment key-ways to reduce incidents of damage due to improper engagement.

Guidelines by Category (Cont'd)

Category No.	Category Title	Guideline No.	Guideline
3.01	Connections	EC-25	Use positive locking, quick disconnect electrical connectors to save man-hours, prevent foreign object damage (FOD) and decrease the chance of personal injury.
		EC-26	Avoid using identical electrical connectors in adjacent areas.
		ECS-07	Liquid type refrigeration compressors/packages should contain highly reliable quick disconnects to negate servicing or bleeding subsequent to replacement.
		ENG(G)-01	Provide access to all engine mounts for ground vehicles so that hoisting or crawling under the vehicle is not required.
		ENG(G)-02	Use torque-limiting bolts or torque washers as engine mount attaching hardware to eliminate the need for torque wrenches.
		ENG(G)-03	Design hard points for hoisting or positioning the engine during installation and removal to be integral to the engine and capable of hoisting and supporting a fully-built-up engine package.
		ENG(G)-04	Do not use downward engine removal concepts that require jacking or hoisting of the ground vehicle.
		ENG(G)-05	Use concepts for removing ground vehicle engines from the front, rear, or side rather than from overhead (using hoisting).
		ENG(G)-06	The distance between the engine and firewall should ensure the access envelopes to lines, fittings, wiring, and adjustments will accommodate the 75 percentile male hand.
		ENG(G)-07	The distance between the cooling fan and radiator core should ensure that access envelopes will not require removal of the core.
		ENG(G)-08	The interface of the engine assembly to the engine compartment and structure should be designed to ensure all spark plugs, glow-plugs, and igniters can be replaced within 30 minutes elapsed time.
		ENG(G)-10	Design attaching hardware for all mechanical engine-to-vehicle interfaces to be captive and with integral safeties.
		ENG(G)-11	Use "torq-set" type clamps or equivalent in all cooling system hose interfaces to eliminate torque wrenches and the potential for error.
		ENG(G)-12	Provide a clear and viewable access envelope to fuel and oil filters.
		ENG(G)-13	Locate fuel filters to ensure no safety hazard will exist due to residual fuel during filter change.
		ENG(G)-14	Access envelopes to fuel and oil filters should not be in close proximity to exhaust manifolds or cooling system return lines.
		ENG(G)-15	Any single drive belt (excluding timing belts) should be capable of replacement within 30 minutes elapsed time
		ENG(G)-16	Do not locate batteries in the engine compartment. In those instances where this is not possible:
			- The battery support structure should be of a material that is impervious to acid leakage or boil-over.
			- The battery support structure should serve as a scupper to collect and direct the acid out of the engine compartment.
		ENG(G)-17	Install simple, lightweight shields over cooling system return lines to protect personnel from hose or line blowout during maintenance.
		ENG(G)-20	Design all firewall fittings, connectors, and penetrations to be fully viewable and directly accessible to the maintainers.
		ENG-07	Plumbing and wiring spanning two or more engine modules should contain in-line disconnects to enhance and simplify engine modularization.
		ENG-08	Use V-band clamps to mount accessories to engine-mounted gear boxes.
		ENG-09	On multi-engine air vehicles, the engines should be capable of being installed in any engine cavity without need for reconfiguration.
		ENG-10	On multi-engine air vehicles, the airframe-to-engine interfaces should be in identical positions or orientations for each engine cavity.
		ENG-11	Control-by-wire or control-by-light throttling concepts should take precedence over mechanical controls.
		ENG-12	All engine-mounted accessories must be capable of being removed and installed through the available airframe access openings.
		ENG-23	All engine borescope provisions should be accessible with the engine installed and hooked up.
		ENG-24	Replacement of all ignitors should be possible with the engine installed.

Guidelines by Category (Cont'd)

Category No.	Category Title	Guideline No.	Guideline
3.01	Connections	ENG-25	All engine-to-airframe plumbing, wiring, and duct interfaces should be capable of being connected or disconnected by hand, should contain integral safety provisions, and should not require torquing.
		ENG-26	Locate and position engine overheat and fire warning sensors so that damage cannot occur during engine maintenance or replacement.
		ENG-31	No rigging or calibration should be required subsequent to replacement of any engine-mounted component.
		ENG-36	All borecope mechanisms should have positive integral locking features.
		ENG-38	The characteristics of engine-to-vehicle interfaces coupled with the capabilities of electronic engine controls, should negate the necessity for making any type of engine rigging including maximum power, idle, and idle cut-off.
		ENG-39	Engine-to-vehicle plumbing quick disconnects should contain positive visual indication that the interface is fully seated and locked.
		ENG-41	Use captive fasteners containing self-locking features to attach the nose dome to the engine face. The fasteners should be fully viewable during engine face FOD inspections.
		ENG-42	Attach engine-to-inlet duct interface seals to the vehicle so they can be left in place during engine removal.
		ENG-43	Design engine-to-inlet duct seal so the interface is automatic during engine installation without needing any form of alignment, adjustment, or mechanical attachment interface.
		ENG-44	Select engine-to-inlet duct seal material to ensure seal life is sufficient for the life of the vehicle.
		ENG-45	Provide remote servicing points accessible from the ground to service engine accessories mounted on top of the engine (e.g., oil tanks, gear boxes, generators, etc.) to eliminate climbing upon or atop the host vehicle.
		ENG-46	Design the basic engine and engine-mounted accessory interface so that no fluid traps or bathtubs exist regardless of engine-mounted accessory location.
		ENG-47	Design the engine, including all accessories, plumbing, wiring, ducts, and mechanisms, to meet the same environmental protection and compatibility requirements as the host vehicle.
		ENG-49	Design engine fuel and oil filters with integral locking features so they can be installed and removed by hand, and require no torquing.
		ENG-50	Design engine fuel and oil filter delta pressure indicators so they can be reset only from within the filter housing.
		ENG-51	Provide engine fuel and oil filters with anti-surge protection to ensure false delta pressure indications do not occur.
		EXT-01	Locate Tanks, Pods, Containers, and Devices (TPCD's) so they do not block or restrict access to existing vehicle access areas or access approach envelopes.
		EXT-02	Design TPCD's for fuel containment to automatically interface to the host vehicle during installation or removal.
		EXT-03	Design TPCD's to be fully compatible with the existing vehicle built-in hoisting provisions and locking devices.
		FUEL-04	Where the fuel wetted area inside a fuel cell or tank is void of blade, knife, and hat stiffeners for use as hardpoint attachment, standoff's bonded to the cell surface should be used as attachments for clamps, and brackets to eliminate fastener penetration of the fuel cavity.
		HOOK-01	Locate, orient, and mechanize Nose Gear Tow/Nose Gear Holdback (NGT/NGH) mechanisms so they do not interfere with the hookup and attachment of standard towbars.
		HOOK-02	Design NGT/NGH mechanisms with integral provisions to visually indicate correct hookup/attachment. The indication must be visible during all day and night carrier operations.
		HOOK-03	NGT/NGH mechanisms should not require scheduled visual or NDI type inspections.
		HYD-01	For military combat vehicles having two or more hydraulic power systems, provide a minimum 30-inch spacing between ground power and servicing interfaces to ensure: <ul style="list-style-type: none"> - Design flexibility in locating and arranging equipment in high-density vehicles such as fighters and helicopters, - Work area separation to enable concurrent service/maintenance on systems, - Systems vulnerability enhancement, - Reduction in turn-around elapsed time due to concurrent servicing capability.
		HYD-05	Design protective caps or covers over service fittings with steel cable lanyards to prevent loss and migration in the vehicle.

MIL-HDBK-470A

APPENDIX C

Guidelines by Category (Cont'd)

Category No.	Category Title	Guideline No.	Guideline
3.01	Connections		
		HYD-06	Mount hydraulic pumps to the gear box flange with v-band clamps containing a torq-set or equivalent fastener.
		HYD-11	Design flexible hose with molded-in color bands to clearly indicate when the maximum wear/abrasion has been reached.
		IN(V)-01	Design inlet door actuators and door actuation mechanisms so they not protrude into the air inlet flow field to eliminate FOD potential.
		IN(V)-02	Do not use loose structural fasteners in the access area to inlet door actuators and mechanisms. Where this guideline cannot be followed, design the actuator door to be accessible only when the inlet doors are fully closed.
		IN(V)-03	For engine inlet bellmouth fairings, use methods of retention other than fasteners. Latches may be considered as an acceptable alternative only if latch-to-panel retention is from the inner mold line.
		LG-02	Hardpoints for attachment of landing gear trunnions should be capable of carrying all induced gear loads for the life of the airframe.
		LG-03	Hardpoints for attachment for landing gear trunnions should not be machined as an integral part of the airframe structure when normal design sink rates over 25 feet per second are required.
		LG-06	Design struts, attachments, and interfaces so they do not depend on scheduled visual inspections, non-destructive inspection (NDI), or non-destructive test (NDT) to ensure the reliability or integrity of the system in the operational environment.
		LG-07	No portion of the landing gear struts, drag braces, or interfaces should contain pockets or bathtubs that can trap or hold moisture. In rare instances where this is not possible, holes should be drilled as appropriate to prevent moisture/liquid accumulation.
		LG-08	Brackets, levers, links, rods, et al mounted on the struts should either be symmetrical to tolerate reverse installation or should be impossible to reverse.
		LG-09	Use coiled tubing in lieu of flex lines or hoses for hydraulic line routing from the airframe to the strut.
		LG-10	All wiring or coax mounted to a strut should have appropriate interface connectors to simplify strut removal and installation.
		LG-14	All interfaces from the airframe to the struts should be visible and accessible, and not require removal of airframe structure for access.
		LG-15	No portion of the landing gear closure door(s) should be attached to the strut. In rare instances where this may not be possible, that attached portion should not require alignment or rigging.
		LG-16	No portion of the landing gear rigging process should require support equipment type templates, gauges, or tools. Indexes, reference points, etc., should be an integral part of the landing gear/airframe design.
		LG-18	Landing gear ground safety down locks should be an integral part of the overall design. Use or reliance on loose pins (support equipment) should be avoided.
		LG-19	When deemed necessary for the respective design, pilots, flight crews, or operators should have an indication of the downlock status in the cockpit or crew station to avoid the necessity of a flight abort.
		LG-20	Special locks and pins used solely for landing gear ground maintenance safety should be used only in those cases substantiated by cost effectiveness analysis.
		LG-21	Proximity type switches used in landing gear design should meet a minimum of 200 volt-amperes to eliminate Electromagnetic Interference (EMI) or Radiation Hazard (RADHAD) problems. Wiring associated with the landing gear design should meet the same requirements.
		LG-23	Design strut fittings for servicing nitrogen or hydraulic fluid to be easily accessible and adjacent to the appropriate strut pressure gage.
		LG-24	Design struts so they can be serviced with clean, dry air in lieu of nitrogen during deployments without affecting the overall reliability.
		LG-25	Mechanical shrink struts, when used, should not permit gear to jam in wheel well if failure of shrink mechanism occurs.
		LG-31	Landing gear doors designed to close after gear is extended should be capable of being manually opened on the ground without reliance on electrical or hydraulic power.
		LG-32	Design of landing gear doors normally closed after gear extension should ensure failure modes will not enable uncommanded opening on the ground.

Guidelines by Category (Cont'd)

Category No.	Category Title	Guideline No.	Guideline
3.01	Connections		
		LG-33	Design of landing gear doors normally left open after gear extension should ensure no failure mode will enable closing on the ground.
		LG-34	Avoid sharp edges and corners on landing gear doors or fairings.
		MC-01	All clamps should contain torque-set or torque-limiting connections to prevent clamp or component failure due to over-torque. Clamp installation call outs should not depend on special tools to establish the required torque values.
		MC-02	Avoid the use of cotter pins, safety wire, safety clips, and similar devices to prevent maintenance-induced events leading to ground vehicle accidents or loss of air vehicles.
		MC-03	All tubing connections and interfaces should use rosan/dynatube (or equivalent) to (1) enable connect or disconnect with one hand, one tool, (2) eliminate the need to safety the connection, (3) provide a superior seal, and (4) negate need to reposition line(s) during component replacement.
		MC-04	No trombone type, flared tube type, or piloted line type interfaces should be used to avoid the need for removal or repositioning during equipment removal.
		MC-05	Avoid potential foreign object traps during manufacturing or operational maintenance by eliminating vertical penetrations of plumbing/fittings into tanks, compartments, or cells
		MC-06	Locate, position, orient all plumbing and duct electrical connectors to prevent the need for sequential installation or removal.
		MC-07	Maximize areas of constant web thickness in firewalls, carry-through bulkheads, major frames, structural ribs, spars, webs, keels, and close-outs to provide flexibility in locating penetration fittings. Stepped chem milling, stepped machining, stepped composite layup concepts all tend to result in minimal available surface area for penetrations.
		MC-08	All in-line plumbing connections within a fuel tank or cell should be capable of making/breaking the interface by hand, require no torque, contain integral safety locking mechanisms, and should be void of any requirement for safety wire.
		MC-09	All plumbing connections and fittings used for fuel systems should contain integral bonding features to eliminate the need for bonding clamps or jumper cables.
		MC-10	In rare instances where a plumbing run contains complex form or geometry that would require removal of other plumbing or equipment for access, in-line connectors should be incorporated to maintain the integrity of other plumbing or equipment.
		MC-11	No subsystem plumbing, equipment, or wiring should use a tank, cell, or compartment containing liquids as a means for routing or penetration simplicity during manufacture.
		MC-12	All plumbing and connectors containing liquids should be meniscus-free.
		MC-13	In instances where plumbing or connector interfaces cannot or are not keyed for a specific orientation, all identification, markings, cautions, and directions should be placed 360 degrees around the tube or duct.
		MC-14	Where multiple connectors are located in close proximity, ensure (1) a minimum hand tool arc of 120 degrees can be maintained, and (2) stagger fittings to ensure firm coupling interface/hand tool interface can be accomplished without inducing damage to adjacent lines.
		MC-15	Route, orient, and position plumbing, wiring, ducts, and connectors sufficiently away from the outer surface of the vehicle to preclude induced damage due to minor dents, drill bits during repair, etc. Minimum rule of thumb is 1" away from the inner surface and 1" below a plate nut channel.
		MP-01	Avoid the use epoxies to mount parts on repairable modules because they make repair extremely difficult.
		MP-02	Use a unique identification (ID) resistor incorporated in each system module to verify that the proper module is mounted on ATE.
		MP-03	Design modules so that lengthy warm-up times, special coding and air purity levels, and similar constraints are not necessary.
		PERS-01	Group man-machine interfaces manifold-style to enable connect/disconnect in a single action.
		PERS-02	Include an integral, highly visible indicator in a man-machine interface connector to denote connector is seated and locked.
		PERS-03	Design interface connectors so that a distinct action is required by an individual to effect a disconnect. (Excludes airframe-to-ejection seat personnel interfaces.)

MIL-HDBK-470A

APPENDIX C

Guidelines by Category (Cont'd)

Category No.	Category Title	Guideline No.	Guideline
3.01	Connections	PERS-04	Interfaces should contain an emergency release mechanism that can be activated by rescue personnel with a 95 percentile gloved hand.
		PERS-05	Design emergency interface release mechanisms to be clearly visible under all types of lighting situations.
		PYRO-14	Design weapon drop and fire/release circuits with frequency-coded firing systems or similar concepts to ensure stray energy tests and checks will not be required and that stray energy will not impose a safety hazard or problem.
		PYRO-15	Pylon-to-weapon and pylon-to-air vehicle electrical interfaces should contain built-in test/fault location capabilities.
		PYRO-27	Incorporate integral hoisting provisions at each weapon/store station to enable direct lift from the container or carrier to the attachment hardpoints.
		PYRO-45	Missile ejectors should be provided with repeatable missile motor fire wires to simplify loading and reduce elapsed time.
		R-01	Large radomes wherein the combination of the diameter and length exceeds 60" should be top-hinged. Hinge should be load-carrying to reduce radome retention fastener count.
		SABCH-06	Structural design should avoid the potential of dissimilar material or fastener corrosion.
		SABCH-07	No structural fasteners should be used that require special tools for installation.
		SABCH-08	Taper pins should be threaded and retained with self-locking hardware.
		SABCH-09	Pins and collars (lockbolts) should only be used in applications which do not normally require removal.
		SABCH-10	Do not use lockbolts in composites.
		SIMP-03	Speed brake or speed brake cavity should contain integral mechanical locking mechanism for personnel safety.
		SKID-04	Design pneumatic floats with an integral air gage located adjacent to the air fill fitting.
		TCR-07	Design mechanical interfaces to transmissions, clutches, and rotors so that the respective unit can be replaced without the need for rigging.
		WBAY-02	Pylon-to-wing electrical or plumbing interfaces should have automatic close-out covers when pylon is jettisoned or not installed.
		WBAY-06	Pylon rigging should not be required for gap seal control.
		WBAY-07	Gap seal should not degrade interchangeability of pylon.
		WBAY-08	Gap seal and treatment should be fully compatible with steam from carrier catapults.
		WBAY-09	Gap seal/pylon should not cover or hamper access to low point wing drains.
WBAY-10	No loose hardware should exist before or after pylon is installed.		
WBAY-12	Pylon-to-store/weapon gap seal should permit visual and physical access during loading for all interfaces between bomb rack-to-store, bomb rack-to-launcher, and launcher-to-store.		
WBAY-13	Pylon-to-store/weapon gap seal should not interfere with automatic sway brace function.		
WBAY-14	Pylon-to-store/weapon gap seal should permit physical access to lanyards.		
WBAY-16	Gap seals should not degrade loading while wearing arctic or chemical, biological, or radiation protective clothing.		
WT&B-09	Brake clips, end plates, retainers, etc. used to build up wheel, tire, and brake assemblies should not be capable of reverse or improper installation.		
WT&B-11	Wheel axle nuts should contain integral retention devices or safetying features. In rare instances where this cannot be accomplished, a bolt and self-locking nut should be used. Locking rings and similar devices that can fail and cause FOD should be avoided.		
WT&B-16	Do not use potting compounds for electrical connector environmental protection because it tends to revert and significantly increases repair time.		
WT&B-17	Electrical connector environmental protection should be capable of withstanding water pressure streams up to 120 psi encountered during decontamination, wash, etc.		
WT&B-18	Route brake lines so that line failure will not occur due to tire blow out or separation of recapped treads.		
A-08	Plumbing penetrations into a compartment should not be on a vertical axis due to difficulty in making or breaking vertically-oriented connections. When compartment access is from the bottom, vertically-oriented connections can allow fluid to leak onto the maintainer. When access is from the top, such connections can allow foreign matter to enter the line. Use horizontal penetrations whenever possible.		
3.01.01	Plumbing, Hoses, Fittings, and Quick Disconnects		

Guidelines by Category (Cont'd)

Category No.	Category Title	Guideline No.	Guideline
3.01.01	Plumbing, Hoses, Fittings, and Quick Disconnects	A-13	Two-sided or two-surfaced access should not be required for access to equipment interfaces and hardpoints. The term two-sided infers top/bottom, left/right, front/back, or combinations thereof.
		BIT-06	Mission critical functions should be monitored by BIT.
		BIT-09	Use concurrent BIT to monitor system critical functions.
		C-01	Avoid swivel type connectors and fittings for air, fuel, or hydraulic line interfaces due to their history of low reliability.
		C-02	Provide spacing between parallel plumbing runs so that in-line couplings can be replaced without removing lines or disconnecting any line support devices.
		CBR-01	Orient all vehicle liquid servicing fittings to ensure fluids will not come in contact with protective garb during connect/disconnect activities.
		CC-11	Orient spare wires and cable pigtails along the outer diameter or periphery of connectors to make access easier.
		CC-12	Build up and assemble straight and angle connector shells or back shells in a manner that ensures that wire or cable strain or wear is not possible.
		CREW-04	Avoid wiring, coax, and plumbing penetrations through the floor of crew cabs, operators' compartments, crew stations, cockpits, and passenger compartments.
		ECS-04	Plumbing, lines, or hoses containing hot liquids, toxic gases or liquids should be external to operator, crew, or passenger stations.
		ECS-07	Liquid type refrigeration compressors/packages should contain highly reliable quick disconnects to negate servicing or bleeding subsequent to replacement.
		ECS-24	System design and integration and technology application should be such that requirements for torque is not required.
		ECS-26	Design and integrate components whose proper operation depends on the direction of flow such that they cannot be incorrectly installed.
		ENG(G)-06	The distance between the engine and firewall should ensure the access envelopes to lines, fittings, wiring, and adjustments will accommodate the 75 percentile male hand.
		ENG(G)-10	Design attaching hardware for all mechanical engine-to-vehicle interfaces to be captive and with integral safeties.
		ENG(G)-11	Use "torq-set" type clamps or equivalent in all cooling system hose interfaces to eliminate torque wrenches and the potential for error.
		ENG(G)-12	Provide a clear and viewable access envelope to fuel and oil filters.
		ENG(G)-13	Locate fuel filters to ensure no safety hazard will exist due to residual fuel during filter change.
		ENG(G)-14	Access envelopes to fuel and oil filters should not be in close proximity to exhaust manifolds or cooling system return lines.
		ENG(G)-20	Design all firewall fittings, connectors, and penetrations to be fully viewable and directly accessible to the maintainers.
		ENG-05	All engine-mounted air and fluid lines should be located next to the fan case, engine case, or full-length fan duct to ensure quick and simple replacement of accessories and components.
		ENG-07	Plumbing and wiring spanning two or more engine modules should contain in-line disconnects to enhance and simplify engine modularization.
		ENG-08	Use V-band clamps to mount accessories to engine-mounted gear boxes.
		ENG-10	On multi-engine air vehicles, the airframe-to-engine interfaces should be in identical positions or orientations for each engine cavity.
		ENG-25	All engine-to-airframe plumbing, wiring, and duct interfaces should be capable of being connected or disconnected by hand, should contain integral safety provisions, and should not require torquing.
		ENG-38	The characteristics of engine-to-vehicle interfaces coupled with the capabilities of electronic engine controls, should negate the necessity for making any type of engine rigging including maximum power, idle, and idle cut-off.
		ENG-39	Engine-to-vehicle plumbing quick disconnects should contain positive visual indication that the interface is fully seated and locked.
		ENG-46	Design the basic engine and engine-mounted accessory interface so that no fluid traps or bathtubs exist regardless of engine-mounted accessory location.

Guidelines by Category (Cont'd)

Category No.	Category Title	Guideline No.	Guideline
3.01.01	Plumbing, Hoses, Fittings, and Quick Disconnects	ENG-47	Design the engine, including all accessories, plumbing, wiring, ducts, and mechanisms, to meet the same environmental protection and compatibility requirements as the host vehicle.
		EXTING-05	Route and locate all tube, wire, and plumbing interfaces in a manner that prevents induced damage during maintenance.
		FUEL-04	Where the fuel wetted area inside a fuel cell or tank is void of blade, knife, and hat stiffeners for use as hardpoint attachment, standoff bonded to the cell surface should be used as attachments for clamps, and brackets to eliminate fastener penetration of the fuel cavity.
		HYD-01	For military combat vehicles having two or more hydraulic power systems, provide a minimum 30-inch spacing between ground power and servicing interfaces to ensure: <ul style="list-style-type: none"> - Design flexibility in locating and arranging equipment in high-density vehicles such as fighters and helicopters, - Work area separation to enable concurrent service/maintenance on systems, - Systems vulnerability enhancement, - Reduction in turn-around elapsed time due to concurrent servicing capability.
		HYD-05	Design protective caps or covers over service fittings with steel cable lanyards to prevent loss and migration in the vehicle.
		HYD-06	Mount hydraulic pumps to the gear box flange with v-band clamps containing a torq-set or equivalent fastener.
		HYD-11	Design flexible hose with molded-in color bands to clearly indicate when the maximum wear/abrasion has been reached.
		IN(V)-01	Design inlet door actuators and door actuation mechanisms so they not protrude into the air inlet flow field to eliminate FOD potential.
		LG-06	Design struts, attachments, and interfaces so they do not depend on scheduled visual inspections, non-destructive inspection (NDI), or non-destructive test (NDT) to ensure the reliability or integrity of the system in the operational environment.
		LG-07	No portion of the landing gear struts, drag braces, or interfaces should contain pockets or bathubs that can trap or hold moisture. In rare instances where this is not possible, holes should be drilled as appropriate to prevent moisture/liquid accumulation.
		LG-08	Brackets, levers, links, rods, et al mounted on the struts should either be symmetrical to tolerate reverse installation or should be impossible to reverse.
		LG-09	Use coiled tubing in lieu of flex lines or hoses for hydraulic line routing from the airframe to the strut.
		LG-10	All wiring or coax mounted to a strut should have appropriate interface connectors to simplify strut removal and installation.
		MC-01	All clamps should contain torque-set or torque-limiting connections to prevent clamp or component failure due to over-torque. Clamp installation call outs should not depend on special tools to establish the required torque values.
		MC-02	Avoid the use of cotter pins, safety wire, safety clips, and similar devices to prevent maintenance-induced events leading to ground vehicle accidents or loss of air vehicles.
		MC-03	All tubing connections and interfaces should use rosan/dynatube (or equivalent) to (1) enable connect or disconnect with one hand, one tool, (2) eliminate the need to safety the connection, (3) provide a superior seal, and (4) negate need to reposition line(s) during component replacement.
		MC-04	No trombone type, flared tube type, or piloted line type interfaces should be used to avoid the need for removal or repositioning during equipment removal.
		MC-05	Avoid potential foreign object traps during manufacturing or operational maintenance by eliminating vertical penetrations of plumbing/fittings into tanks, compartments, or cells
		MC-06	Locate, position, orient all plumbing and duct electrical connectors to prevent the need for sequential installation or removal.
		MC-07	Maximize areas of constant web thickness in firewalls, carry-through bulkheads, major frames, structural ribs, spars, webs, keels, and close-outs to provide flexibility in locating penetration fittings. Stepped chem milling, stepped machining, stepped composite layup concepts all tend to result in minimal available surface area for penetrations.
		MC-08	All in-line plumbing connections within a fuel tank or cell should be capable of making/breaking the interface by hand, require no torque, contain integral safety locking mechanisms, and should be void of any requirement for safety wire.

MIL-HDBK-470A

APPENDIX C

Guidelines by Category (Cont'd)

Category No.	Category Title	Guideline No.	Guideline
3.01.01	Plumbing, Hoses, Fittings, and Quick Disconnects	MC-09	All plumbing connections and fittings used for fuel systems should contain integral bonding features to eliminate the need for bonding clamps or jumper cables.
		MC-10	In rare instances where a plumbing run contains complex form or geometry that would require removal of other plumbing or equipment for access, in-line connectors should be incorporated to maintain the integrity of other plumbing or equipment.
		MC-11	No subsystem plumbing, equipment, or wiring should use a tank, cell, or compartment containing liquids as a means for routing or penetration simplicity during manufacture.
		MC-12	All plumbing and connectors containing liquids should be meniscus-free.
		MC-13	In instances where plumbing or connector interfaces cannot or are not keyed for a specific orientation, all identification, markings, cautions, and directions should be placed 360 degrees around the tube or duct.
		MC-14	Where multiple connectors are located in close proximity, ensure (1) a minimum hand tool arc of 120 degrees can be maintained, and (2) stagger fittings to ensure firm coupling interface/hand tool interface can be accomplished without inducing damage to adjacent lines.
		OXY-08	LOX containers should contain rear mounted, automatic interfaces.
		PERS-01	Group man-machine interfaces manifold-style to enable connect/disconnect in a single action.
		PERS-02	Include an integral, highly visible indicator in a man-machine interface connector to denote connector is seated and locked.
		PERS-03	Design interface connectors so that a distinct action is required by an individual to effect a disconnect. (Excludes airframe-to-ejection seat personnel interfaces.)
		PERS-04	Interfaces should contain an emergency release mechanism that can be activated by rescue personnel with a 95 percentile gloved hand.
		PERS-05	Design emergency interface release mechanisms to be clearly visible under all types of lighting situations.
		W-01	Hat section type structural stiffeners with sufficient cross sectional area should be considered as a routing tunnel for wiring and coax.
		WBAY-02	Pylon-to-wing electrical or plumbing interfaces should have automatic close-out covers when pylon is jettisoned or not installed.
3.01.02	Wiring, Connectors, and Fiber Optics	WBAY-10	No loose hardware should exist before or after pylon is installed.
		WT&B-18	Route brake lines so that line failure will not occur due to tire blow out or separation of recapped treads.
		A-11	Locate compartment electrical penetrations close to the access opening for ease of sight, probing, repair, and to eliminate fluid soaking, wicking, or contamination.
		A-12	Locate compartment electrical penetrations far enough from the access opening to prevent damage resulting from improper (over-length) panel fasteners.
		A-13	Two-sided or two-surfaced access should not be required for access to equipment interfaces and hardpoints. The term two-sided infers top/bottom, left/right, front/back, or combinations thereof.
		ARM-08	Weapon and store ejectors containing arming solenoids should ensure the solenoids can be rapidly replaced while installed.
		BIT-01	During design of the BIT, use worst-case stress analysis to ensure that any circuit failures induced by temperature extremes, tolerance build-up, power supply variations, and combinations thereof are identified.
		BIT-02	Ensure that BIT system thresholds are consistent with those across the system, subsystem, item, module, and piece-part levels to prevent excessive numbers of Cannot Duplicate (CND) and Retest OK (RTOK) events from occurring.
		BIT-03	The degree of BIT required or proposed should be based on the respective failure rates and the appropriate FMECA at all equipment indenture levels.
		BIT-04	Limit the amount of data that is recorded to a manageable size by: <ul style="list-style-type: none"> - Limiting the number of signals that are monitored - Limiting the maximum sampling rate - Reducing the time span over which data is accumulated - Restricting the type of data accumulated

Guidelines by Category (Cont'd)

Category No.	Category Title	Guideline No.	Guideline
3.01.02	Wiring, Connectors, and Fiber Optics		
		BIT-05	Incorporate testability design features as an integral part of equipment preliminary design process.
		BIT-06	Mission critical functions should be monitored by BIT.
		BIT-09	Use concurrent BIT to monitor system critical functions.
		BIT-14	Provide access to all BIT control and status signals at module connector pins. This will enable ATE to directly connect to BIT circuitry.
		BIT-16	Critical voltages should be visually monitored by sending the voltage signals to visible LEDs.
		BIT-20	The BIT should be mechanized so that when a piece of equipment is not installed in a subsystem or the product, a failure will not be indicated.
		BIT-26	Locate routinely used test points so they are accessible without removing or disassembling other equipment
		CC-01	Use fiber-optic technologies in preference to conventional interconnect concepts to reduce the number of interconnects/interfaces, reduce manufacturing and ownership costs, and significantly improve R&M.
		CC-02	Standardize connector and wire types to improve testability and logistic support. Keep the number of "different" standard connectors to a minimum. Use the same connector type keyed differently where possible.
		CC-03	Provide clearance around connectors for engagement/disengagement of cables and proper connector orientation under anticipated environmental conditions (e.g., bare hand of 50 percentile male in an enclosed or protected environment and a gloved hand of a 50 percentile male in an open or unprotected environment).
		CC-04	Use quick release cables and locate cables to make removal and replacement easy and to avoid having to remove one cable to gain access to another. Provide adequate space for cables, including sleeving and tie-downs, and adequate service loops for ease of assembly/disassembly
		CC-05	Orient and space connectors to allow a sufficient grip on the connector for cable or wire extraction without fear of using the wiring or cable for additional leverage.
		CC-06	Label, and where possible color code, each wire in a harness or cable to facilitate tracking from origin to termination. Each wire, cable, and coax-to-connector interface should be provided with a source of identification to aid in trouble shooting, repair, or modification. Marking the cable designer on the cable along with bar codes is also recommended.
		CC-07	Do not manufacture or dress connectors containing more than 25 wires or cables as a single integrated harness. Group the wires or cables into runs of no more than 25 wires or cables each. In addition to making trouble shooting and repair easier, this approach help avoid large bend radii, thereby simplifying routing, packaging, and stowage.
		CC-08	Standardize connector pin assignments for power, ground, and other frequently used signals.
		CC-09	Locate LRU/subsystem critical nodes (and or test points) so they are accessible from a connector to prevent the need for internal LRU probing or access.
		CC-10	Avoid hidden cables. Visually inspecting and tracing all assembly cables rather than having hidden cables (such as behind other cables or even LRUs) allows for a quick system and cable integrity check which aids in overall system integrity and debug. This also implies quick access for manipulative actions.
		CC-11	Orient spare wires and cable pigtails along the outer diameter or periphery of connectors to make access easier.
		CC-12	Build up and assemble straight and angle connector shells or back shells in a manner that ensures that wire or cable strain or wear is not possible.
		CREW-04	Avoid wiring, coax, and plumbing penetrations through the floor of crew cabs, operators' compartments, crew stations, cockpits, and passenger compartments.
		EC-01	A threaded electrical connector should contain integral locking mechanisms and visual indications that the connector is properly seated and locked.
		EC-02	An electrical connector requiring less than one full turn to connect or disconnect should contain integral locking mechanisms and visual indications that the connector is properly seated and locked.
		EC-03	A push-pull electrical connector (excluding rack-and-panel type) should contain integral locking features and visual indication that the connector is properly seated and locked.
		EC-04	All electrical connectors should be keyed or asymmetrically shaped to ensure proper alignment.
		EC-05	All electrical connectors should contain scoop-proof shells to ensure pin damage will not occur prior to engaging key way.

Guidelines by Category (Cont'd)

Category No.	Category Title	Guideline No.	Guideline
3.01.02	Wiring, Connectors, and Fiber Optics		
		EC-06	All electrical connectors should be corrosion resistant to reduce or eliminate the need for scheduled inspections or corrosion prevention measures.
		EC-07	Avoid using electrical connectors requiring any type or form of soldering.
		EC-08	Locate and position electrical connectors such that all pin identification for either half can be easily seen.
		EC-09	Electrical connectors selected for critical applications on ground vehicles should be both accessible and capable of being connected disconnected by a fifty percentile gloved male hand.
		EC-10	Separation between grouped electrical connectors should be sufficient to ensure make or break of any connector by a fifty percentile gloved male hand. Where this is not possible, an alternate method should be used such as the use of stand-offs, long-shelled connectors, alternated with standard connectors, 180-degree connectors alternated with 90-degree connectors, or innovative equivalents.
		EC-11	Avoid connectors requiring potting as a method for environmental protection due to lengthy repair time and tendency for potting compound reversion.
		EC-12	Electrical penetrations into a compartment should not be on a vertical axis to ensure foreign matter does not enter connector.
		EC-13	Electrical, electronic, and coaxial interfaces between fixed and moveable surfaces should contain quick disconnects to simplify replacement of the moveable surface or the electronic module.
		EC-14	Scoop proof connectors should be used throughout unless their use would require an increase in the volume of the aircraft, in which case deviations will be considered on an individual basis.
		EC-15	The removal or replacement of electronic equipment should not require the removal of any other piece of equipment or armament.
		EC-16	Select connectors so that contacts on the "live" or "hot" side of the connection are socket type rather than pin type to minimize personnel hazard and to prevent accidental shorting of live circuits.
		EC-17	Whenever possible, use self-locking connector plugs of a type not requiring safety wire.
		EC-18	All electric connectors should be environment resistant.
		EC-19	Connectors containing fiber optic contacts should, whenever possible, be mounted on a vertical surface to prevent particle and fluid contamination.
		EC-20	Use quick disconnect connectors where allowed and identify all pins on each connector.
		EC-21	Locate connectors far enough apart so that they meet specified requirements.
		EC-22	All connectors should be keyed differently with aligning pins that extend beyond the electrical pins. Connector pins and sockets should engage after key position is entered.
		EC-23	Design connectors so that plugs are cold and receptacles are hot.
		EC-24	Use electrical connectors that incorporate alignment key-ways to reduce incidents of damage due to improper engagement.
		EC-25	Use positive locking, quick disconnect electrical connectors to save man-hours, prevent foreign object damage (FOD) and decrease the chance of personal injury.
		EC-26	Avoid using identical electrical connectors in adjacent areas.
		ENG(G)-06	The distance between the engine and firewall should ensure the access envelopes to lines, fittings, wiring, and adjustments will accommodate the 75 percentile male hand.
		ENG(G)-10	Design attaching hardware for all mechanical engine-to-vehicle interfaces to be captive and with integral safeties.
		ENG(G)-20	Design all firewall fittings, connectors, and penetrations to be fully viewable and directly accessible to the maintainers.
		ENG-07	Plumbing and wiring spanning two or more engine modules should contain in-line disconnects to enhance and simplify engine modularization.
		ENG-10	On multi-engine air vehicles, the airframe-to-engine interfaces should be in identical positions or orientations for each engine cavity.
		ENG-11	Control-by-wire or control-by-light throttling concepts should take precedence over mechanical controls.

Guidelines by Category (Cont'd)

Category No.	Category Title	Guideline No.	Guideline
3.01.02	Wiring, Connectors, and Fiber Optics		
		ENG-25	All engine-to-airframe plumbing, wiring, and duct interfaces should be capable of being connected or disconnected by hand, should contain integral safety provisions, and should not require torquing.
		ENG-26	Locate and position engine overheat and fire warning sensors so that damage cannot occur during engine maintenance or replacement.
		ENG-38	The characteristics of engine-to-vehicle interfaces coupled with the capabilities of electronic engine controls, should negate the necessity for making any type of engine rigging including maximum power, idle, and idle cut-off.
		ENG-39	Engine-to-vehicle plumbing quick disconnects should contain positive visual indication that the interface is fully seated and locked.
		ENG-47	Design the engine, including all accessories, plumbing, wiring, ducts, and mechanisms, to meet the same environmental protection and compatibility requirements as the host vehicle.
		EXT-01	Locate Tanks, Pods, Containers, and Devices (TPCD's) so they do not block or restrict access to existing vehicle access areas or access approach envelopes.
		EXT-02	Design TPCD's for fuel containment to automatically interface to the host vehicle during installation or removal.
		EXT-03	Design TPCD's to be fully compatible with the existing vehicle built-in hoisting provisions and locking devices.
		EXTING-05	Route and locate all tube, wire, and plumbing interfaces in a manner that prevents induced damage during maintenance.
		LG-08	Brackets, levers, links, rods, et al mounted on the struts should either be symmetrical to tolerate reverse installation or should be impossible to reverse.
		LG-09	Use coiled tubing in lieu of flex lines or hoses for hydraulic line routing from the airframe to the strut.
		LG-10	All wiring or coax mounted to a strut should have appropriate interface connectors to simplify strut removal and installation.
		LG-11	All microswitches, proximity switches, lights, sensors, etc. mounted to a strut should have individual interface connectors.
		LG-14	Wiring pigtailed requiring in-line splices should be avoided.
		LG-21	All interfaces from the airframe to the struts should be visible and accessible, and not require removal of airframe structure for access.
		MC-02	Proximity type switches used in landing gear design should meet a minimum of 200 volt-amperes to eliminate Electromagnetic Interference (EMI) or Radiation Hazard (RADHAD) problems. Wiring associated with the landing gear design should meet the same requirements.
		MC-06	Avoid the use of cotter pins, safety wire, safety clips, and similar devices to prevent maintenance-induced events leading to ground vehicle accidents or loss of air vehicles.
		MC-10	Locate, position, orient all plumbing and duct electrical connectors to prevent the need for sequential installation or removal.
		MC-12	In rare instances where a plumbing run contains complex form or geometry that would require removal of other plumbing or equipment for access, in-line connectors should be incorporated to maintain the integrity of other plumbing or equipment.
		MC-14	All plumbing and connectors containing liquids should be meniscus-free.
		PYRO-15	Where multiple connectors are located in close proximity, ensure (1) a minimum hand tool arc of 120 degrees can be maintained, and (2) stagger fittings to ensure firm coupling interface/hand tool interface can be accomplished without inducing damage to adjacent lines.
		PYRO-45	Pylon-to-weapon and pylon-to-air vehicle electrical interfaces should contain built-in test/fault location capabilities.
		TP-01	Missile ejectors should be provided with repeatable missile motor fire wires to simplify loading and reduce elapsed time.
		TP-02	Locate Input/Output (I/O) test points and associated readouts in close proximity to each other so that one person can perform testing.
		TP-03	Protect test points against the environment and from induced contamination.
		W-01	Protect test points from outside signal generation. Hat section type structural stiffeners with sufficient cross sectional area should be considered as a routing tunnel for wiring and coax.

Guidelines by Category (Cont'd)

Category No.	Category Title	Guideline No.	Guideline
3.01.02	Wiring, Connectors, and Fiber Optics	WBAY-02	Pylon-to-wing electrical or plumbing interfaces should have automatic close-out covers when pylon is jettisoned or not installed.
		WBAY-10	No loose hardware should exist before or after pylon is installed.
		WBAY-16	Gap seals should not degrade loading while wearing arctic or chemical, biological, or radiation protective clothing.
		WT&B-16	Do not use potting compounds for electrical connector environmental protection because it tends to revert and significantly increases repair time.
		WT&B-17	Electrical connector environmental protection should be capable of withstanding water pressure streams up to 120 psi encountered during decontamination, wash, etc.
3.01.03	Electrical Connectors	A-11	Locate compartment electrical penetrations close to the access opening for ease of sight, probing, repair, and to eliminate fluid soaking, wicking, or contamination.
		A-12	Locate compartment electrical penetrations far enough from the access opening to prevent damage resulting from improper (over-length) panel fasteners.
		A-13	Two-sided or two-surfaced access should not be required for access to equipment interfaces and hardpoints. The term two-sided infers top/bottom, left/right, front/back, or combinations thereof.
		BIT-01	During design of the BIT, use worst-case stress analysis to ensure that any circuit failures induced by temperature extremes, tolerance build-up, power supply variations, and combinations thereof are identified.
		BIT-02	Ensure that BIT system thresholds are consistent with those across the system, subsystem, item, module, and piece-part levels to prevent excessive numbers of Cannot Duplicate (CND) and Retest OK (RTOK) events from occurring.
		BIT-03	The degree of BIT required or proposed should be based on the respective failure rates and the appropriate FMECA at all equipment indenture levels.
		BIT-04	Limit the amount of data that is recorded to a manageable size by: <ul style="list-style-type: none"> - Limiting the number of signals that are monitored - Limiting the maximum sampling rate - Reducing the time span over which data is accumulated - Restricting the type of data accumulated
		BIT-05	Incorporate testability design features as an integral part of equipment preliminary design process.
		BIT-06	Mission critical functions should be monitored by BIT.
		BIT-09	Use concurrent BIT to monitor system critical functions.
		BIT-14	Provide access to all BIT control and status signals at module connector pins. This will enable ATE to directly connect to BIT circuitry.
		BIT-16	Critical voltages should be visually monitored by sending the voltage signals to visible LEDs.
		BIT-20	The BIT should be mechanized so that when a piece of equipment is not installed in a subsystem or the product, a failure will not be indicated.
		BIT-26	Locate routinely used test points so they are accessible without removing or disassembling other equipment
		CC-01	Use fiber-optic technologies in preference to conventional interconnect concepts to reduce the number of interconnects/interfaces, reduce manufacturing and ownership costs, and significantly improve R&M.
		CC-02	Standardize connector and wire types to improve testability and logistic support. Keep the number of "different" standard connectors to a minimum. Use the same connector type keyed differently where possible.
		CC-03	Provide clearance around connectors for engagement/disengagement of cables and proper connector orientation under anticipated environmental conditions (e.g., bare hand of 50 percentile male in an enclosed or protected environment and a gloved hand of a 50 percentile male in an open or unprotected environment).
		CC-04	Use quick release cables and locate cables to make removal and replacement easy and to avoid having to remove one cable to gain access to another. Provide adequate space for cables, including sleeving and tie-downs, and adequate service loops for ease of assembly/disassembly
		CC-05	Orient and space connectors to allow a sufficient grip on the connector for cable or wire extraction without fear of using the wiring or cable for additional leverage.

Guidelines by Category (Cont'd)

Category No.	Category Title	Guideline No.	Guideline
3.01.03	Electrical Connectors	CC-06	Label, and where possible color code, each wire in a harness or cable to facilitate tracking from origin to termination. Each wire, cable, and coax-to-connector interface should be provided with a source of identification to aid in trouble shooting, repair, or modification. Marking the cable designator on the cable along with bar codes is also recommended.
		CC-07	Do not manufacture or dress connectors containing more than 25 wires or cables as a single integrated harness. Group the wires or cables into runs of no more than 25 wires or cables each. In addition to making trouble shooting and repair easier, this approach help avoid large bend radii, thereby simplifying routing, packaging, and stowage.
		CC-08	Standardize connector pin assignments for power, ground, and other frequently used signals.
		CC-09	Locate LRU/subsystem critical nodes (and or test points) so they are accessible from a connector to prevent the need for internal LRU probing or access.
		CC-10	Avoid hidden cables. Visually inspecting and tracing all assembly cables rather than having hidden cables (such as behind other cables or even LRUs) allows for a quick system and cable integrity check which aids in overall system integrity and debug. This also implies quick access for manipulative actions.
		CC-11	Orient spare wires and cable pigtailed along the outer diameter or periphery of connectors to make access easier.
		CC-12	Build up and assemble straight and angle connector shells or back shells in a manner that ensures that wire or cable strain or wear is not possible.
		CREW-04	A void wiring, coax, and plumbing penetrations through the floor of crew cabs, operators' compartments, crew stations, cockpits, and passenger compartments.
		EC-01	A threaded electrical connector should contain integral locking mechanisms and visual indications that the connector is properly seated and locked.
		EC-02	An electrical connector requiring less than one full turn to connect or disconnect should contain integral locking mechanisms and visual indications that the connector is properly seated and locked.
		EC-03	A push-pull electrical connector (excluding rack-and-panel type) should contain integral locking features and visual indication that the connector is properly seated and locked.
		EC-04	All electrical connectors should be keyed or asymmetrically shaped to ensure proper alignment.
		EC-05	All electrical connectors should contain scoop-proof shells to ensure pin damage will not occur prior to engaging key way.
		EC-06	All electrical connectors should be corrosion resistant to reduce or eliminate the need for scheduled inspections or corrosion prevention measures.
		EC-07	Avoid using electrical connectors requiring any type or form of soldering.
		EC-08	Locate and position electrical connectors such that all pin identification for either half can be easily seen.
		EC-09	Electrical connectors selected for critical applications on ground vehicles should be both accessible and capable of being connected disconnected by a fifty percentile gloved male hand.
		EC-10	Separation between grouped electrical connectors should be sufficient to ensure make or break of any connector by a fifty percentile gloved male hand. Where this is not possible, an alternate method should be used such as the use of stand-offs, long-shelled connectors alternated with standard connectors, 180-degree connectors alternated with 90-degree connectors, or innovative equivalents.
		EC-11	Avoid connectors requiring potting as a method for environmental protection due to lengthy repair time and tendency for potting compound reversion.
		EC-12	Electrical penetrations into a compartment should not be on a vertical axis to ensure foreign matter does not enter connector.
		EC-13	Electrical, electronic, and coaxial interfaces between fixed and moveable surfaces should contain quick disconnects to simplify replacement of the moveable surface or the electronic module.
		EC-14	Scoop proof connectors should be used throughout unless their use would require an increase in the volume of the aircraft, in which case deviations will be considered on an individual basis.
		EC-15	The removal or replacement of electronic equipment should not require the removal of any other piece of equipment or armament.

MIL-HDBK-470A

APPENDIX C

Guidelines by Category (Cont'd)

Category No.	Category Title	Guideline No.	Guideline
3.01.03	Electrical Connectors	EC-16	Select connectors so that contacts on the "live" or "hot" side of the connection are socket type rather than pin type to minimize personnel hazard and to prevent accidental shorting of live circuits.
		EC-17	Whenever possible, use self-locking connector plugs of a type not requiring safety wire.
		EC-18	All electric connectors should be environment resistant.
		EC-19	Connectors containing fiber optic contacts should, whenever possible, be mounted on a vertical surface to prevent particle and fluid contamination.
		EC-20	Use quick disconnect connectors where allowed and identify all pins on each connector.
		EC-21	Locate connectors far enough apart so that they meet specified requirements.
		EC-22	All connectors should be keyed differently with aligning pins that extend beyond the electrical pins. Connector pins and sockets should engage after key position is entered.
		EC-23	Design connectors so that plugs are cold and receptacles are hot.
		EC-24	Use electrical connectors that incorporate alignment key-ways to reduce incidents of damage due to improper engagement.
		EC-25	Use positive locking, quick disconnect electrical connectors to save man-hours, prevent foreign object damage (FOD) and decrease the chance of personal injury.
		EC-26	Avoid using identical electrical connectors in adjacent areas.
		ENG(G)-06	The distance between the engine and firewall should ensure the access envelopes to lines, fittings, wiring, and adjustments will accommodate the 75 percentile male hand.
		ENG(G)-10	Design attaching hardware for all mechanical engine-to-vehicle interfaces to be captive and with integral safeties.
		ENG(G)-20	Design all firewall fittings, connectors, and penetrations to be fully viewable and directly accessible to the maintainers.
		ENG-07	Plumbing and wiring spanning two or more engine modules should contain in-line disconnects to enhance and simplify engine modularization.
		ENG-10	On multi-engine air vehicles, the airframe-to-engine interfaces should be in identical positions or orientations for each engine cavity.
		ENG-24	Replacement of all ignitors should be possible with the engine installed.
		ENG-25	All engine-to-airframe plumbing, wiring, and duct interfaces should be capable of being connected or disconnected by hand, should contain integral safety provisions, and should not require torquing.
		ENG-38	The characteristics of engine-to-vehicle interfaces coupled with the capabilities of electronic engine controls, should negate the necessity for making any type of engine rigging including maximum power, idle, and idle cut-off.
		ENG-39	Engine-to-vehicle plumbing quick disconnects should contain positive visual indication that the interface is fully seated and locked.
		ENG-47	Design the engine, including all accessories, plumbing, wiring, ducts, and mechanisms, to meet the same environmental protection and compatibility requirements as the host vehicle.
		EXT-01	Locate Tanks, Pods, Containers, and Devices (TPCD's) so they do not block or restrict access to existing vehicle access areas or access approach envelopes.
		EXT-02	Design TPCD's for fuel containment to automatically interface to the host vehicle during installation or removal.
		EXT-03	Design TPCD's to be fully compatible with the existing vehicle built-in hoisting provisions and locking devices.
		LG-08	Brackets, levers, links, rods, et al mounted on the struts should either be symmetrical to tolerate reverse installation or should be impossible to reverse.
		LG-09	Use coiled tubing in lieu of flex lines or hoses for hydraulic line routing from the airframe to the strut.
		LG-10	All wiring or coax mounted to a strut should have appropriate interface connectors to simplify strut removal and installation.
		LG-11	All microswitches, proximity switches, lights, sensors, etc. mounted to a strut should have individual interface connectors.
		LG-14	Wiring pigtailed requiring in-line splices should be avoided.
			All interfaces from the airframe to the struts should be visible and accessible, and not require removal of airframe structure for access.

Guidelines by Category (Cont'd)

Category No.	Category Title	Guideline No.	Guideline
3.01.03	Electrical Connectors	LG-21	Proximity type switches used in landing gear design should meet a minimum of 200 volt-amperes to eliminate Electromagnetic Interference (EMI) or Radiation Hazard (RADHAD) problems. Wiring associated with the landing gear design should meet the same requirements.
		MC-02	Avoid the use of cotter pins, safety wire, safety clips, and similar devices to prevent maintenance-induced events leading to ground vehicle accidents or loss of air vehicles.
		MC-10	In rare instances where a plumbing run contains complex form or geometry that would require removal of other plumbing or equipment for access, in-line connectors should be incorporated to maintain the integrity of other plumbing or equipment.
		MC-12	All plumbing and connectors containing liquids should be meniscus-free.
		MC-14	Where multiple connectors are located in close proximity, ensure (1) a minimum hand tool arc of 120 degrees can be maintained, and (2) stagger fittings to ensure firm coupling interface/hand tool interface can be accomplished without inducing damage to adjacent lines.
		PYRO-14	Design weapon drop and fire/release circuits with frequency-coded firing systems or similar concepts to ensure stray energy tests and checks will not be required and that stray energy will not impose a safety hazard or problem.
		PYRO-45	Missile ejectors should be provided with repeatable missile motor fire wires to simplify loading and reduce elapsed time.
		TP-01	Locate Input/Output (I/O) test points and associated readouts in close proximity to each other so that one person can perform testing.
		TP-02	Protect test points against the environment and from induced contamination.
		TP-03	Protect test points from outside signal generation.
		W-01	Hat section type structural stiffeners with sufficient cross sectional area should be considered as a routing tunnel for wiring and coax.
		WBAY-02	Pylon-to-wing electrical or plumbing interfaces should have automatic close-out covers when pylon is jettisoned or not installed.
		WBAY-10	No loose hardware should exist before or after pylon is installed.
		WBAY-12	Pylon-to-store/weapon gap seal should permit visual and physical access during loading for all interfaces between bomb rack-to-store, bomb rack-to-launcher, and launcher-to-store.
		WBAY-13	Pylon-to-store/weapon gap seal should not interfere with automatic sway brace function.
		WBAY-14	Pylon-to-store/weapon gap seal should permit physical access to lanyards.
		WBAY-16	Gap seals should not degrade loading while wearing arctic or chemical, biological, or radiation protective clothing.
		WT&B-16	Do not use potting compounds for electrical connector environmental protection because it tends to revert and significantly increases repair time.
		WT&B-17	Electrical connector environmental protection should be capable of withstanding water pressure streams up to 120 psi encountered during decontamination, wash, etc.
3.01.04	Coaxial Connectors and Wave Guides	A-11	Locate compartment electrical penetrations close to the access opening for ease of sight, probing, repair, and to eliminate fluid soaking, wicking, or contamination.
		A-12	Locate compartment electrical penetrations far enough from the access opening to prevent damage resulting from improper (over-length) panel fasteners.
		A-13	Two-sided or two-surfaced access should not be required for access to equipment interfaces and hardpoints. The term two-sided infers top/bottom, left/right, front/back, or combinations thereof.
		BIT-01	During design of the BIT, use worst-case stress analysis to ensure that any circuit failures induced by temperature extremes, tolerance build-up, power supply variations, and combinations thereof are identified.
		BIT-02	Ensure that BIT system thresholds are consistent with those across the system, subsystem, item, module, and piece-part levels to prevent excessive numbers of Cannot Duplicate (CND) and Retest OK (RTOK) events from occurring.
		BIT-03	The degree of BIT required or proposed should be based on the respective failure rates and the appropriate FMECA at all equipment indenture levels.

Guidelines by Category (Cont'd)

Category No.	Category Title	Guideline No.	Guideline
3.01.04	Coaxial Connectors and Wave Guides	BIT-04	Limit the amount of data that is recorded to a manageable size by: <ul style="list-style-type: none"> - Limiting the number of signals that are monitored - Limiting the maximum sampling rate - Reducing the time span over which data is accumulated - Restricting the type of data accumulated
		BIT-05	Incorporate testability design features as an integral part of equipment preliminary design process.
		BIT-06	Mission critical functions should be monitored by BIT.
		BIT-09	Use concurrent BIT to monitor system critical functions.
		BIT-14	Provide access to all BIT control and status signals at module connector pins. This will enable ATE to directly connect to BIT circuitry.
		BIT-16	Critical voltages should be visually monitored by sending the voltage signals to visible LEDs.
		BIT-20	The BIT should be mechanized so that when a piece of equipment is not installed in a subsystem or the product, a failure will not be indicated.
		CC-01	Use fiber-optic technologies in preference to conventional interconnect concepts to reduce the number of interconnects/interfaces, reduce manufacturing and ownership costs, and significantly improve R&M.
		CC-02	Standardize connector and wire types to improve testability and logistic support. Keep the number of "different" standard connectors to a minimum. Use the same connector type keyed differently where possible.
		CC-03	Provide clearance around connectors for engagement/disengagement of cables and proper connector orientation under anticipated environmental conditions (e.g., bare hand of 50 percentile male in an enclosed or protected environment and a gloved hand of a 50 percentile male in an open or unprotected environment).
		CC-04	Use quick release cables and locate cables to make removal and replacement easy and to avoid having to remove one cable to gain access to another. Provide adequate space for cables, including sleeving and tie-downs, and adequate service loops for ease of assembly/disassembly
		CC-05	Orient and space connectors to allow a sufficient grip on the connector for cable or wire extraction without fear of using the wiring or cable for additional leverage.
		CC-06	Label, and where possible color code, each wire in a harness or cable to facilitate tracking from origin to termination. Each wire, cable, and coax-to-connector interface should be provided with a source of identification to aid in trouble shooting, repair, or modification. Marking the cable designer on the cable along with bar codes is also recommended.
		CC-07	Do not manufacture or dress connectors containing more than 25 wires or cables as a single integrated harness. Group the wires or cables into runs of no more than 25 wires or cables each. In addition to making trouble shooting and repair easier, this approach help avoid large bend radii, thereby simplifying routing, packaging, and stowage.
		CC-08	Standardize connector pin assignments for power, ground, and other frequently used signals.
		CC-09	Locate LRU/subsystem critical nodes (and or test points) so they are accessible from a connector to prevent the need for internal LRU probing or access.
		CC-10	Avoid hidden cables. Visually inspecting and tracing all assembly cables rather than having hidden cables (such as behind other cables or even LRUs) allows for a quick system and cable integrity check which aids in overall system integrity and debug. This also implies quick access for manipulative actions.
		CO-03	Use a test connector to provide test and maintenance bus access to all system and subsystem faults.
		CO-05	Avoid the need for costly adapters for signal communications between system, subsystems, line replaceable units (LRUs) or Weapon Replaceable Assemblies (WRAs), and ATE.
		CREW-04	Avoid wiring, coax, and plumbing penetrations through the floor of crew cabs, operators' compartments, crew stations, cockpits, and passenger compartments.
		EC-01	A threaded electrical connector should contain integral locking mechanisms and visual indications that the connector is properly seated and locked.
		EC-02	An electrical connector requiring less than one full turn to connect or disconnect should contain integral locking mechanisms and visual indications that the connector is properly seated and locked.

Guidelines by Category (Cont'd)

Category No.	Category Title	Guideline No.	Guideline
3.01.04	Coaxial Connectors and Wave Guides	EC-03	A push-pull electrical connector (excluding rack-and-panel type) should contain integral locking features and visual indication that the connector is properly seated and locked.
		EC-04	All electrical connectors should be keyed or asymmetrically shaped to ensure proper alignment.
		EC-05	All electrical connectors should contain scoop-proof shells to ensure pin damage will not occur prior to engaging key way.
		EC-06	All electrical connectors should be corrosion resistant to reduce or eliminate the need for scheduled inspections or corrosion prevention measures.
		EC-07	Avoid using electrical connectors requiring any type or form of soldering.
		EC-08	Locate and position electrical connectors such that all pin identification for either half can be easily seen.
		EC-09	Electrical connectors selected for critical applications on ground vehicles should be both accessible and capable of being connected disconnected by a fifty percentile gloved male hand.
		EC-10	Separation between grouped electrical connectors should be sufficient to ensure make or break of any connector by a fifty percentile gloved male hand. Where this is not possible, an alternate method should be used such as the use of stand-offs, long-shelled connectors, alternated with standard connectors, 180-degree connectors alternated with 90-degree connectors, or innovative equivalents.
		EC-11	Avoid connectors requiring potting as a method for environmental protection due to lengthy repair time and tendency for potting compound reversion.
		EC-12	Electrical penetrations into a compartment should not be on a vertical axis to ensure foreign matter does not enter connector.
		EC-13	Electrical, electronic, and coaxial interfaces between fixed and moveable surfaces should contain quick disconnects to simplify replacement of the moveable surface or the electronic module.
		EC-14	Scoop proof connectors should be used throughout unless their use would require an increase in the volume of the aircraft, in which case deviations will be considered on an individual basis.
		EC-15	The removal or replacement of electronic equipment should not require the removal of any other piece of equipment or armament.
		EC-16	Select connectors so that contacts on the "live" or "hot" side of the connection are socket type rather than pin type to minimize personnel hazard and to prevent accidental shorting of live circuits.
		EC-17	Whenever possible, use self-locking connector plugs of a type not requiring safety wire.
		EC-18	All electric connectors should be environment resistant.
		EC-19	Connectors containing fiber optic contacts should, whenever possible, be mounted on a vertical surface to prevent particle and fluid contamination.
		EC-20	Use quick disconnect connectors where allowed and identify all pins on each connector.
		EC-21	Locate connectors far enough apart so that they meet specified requirements.
		EC-22	All connectors should be keyed differently with aligning pins that extend beyond the electrical pins. Connector pins and sockets should engage after key position is entered.
		EC-23	Design connectors so that plugs are cold and receptacles are hot.
		EC-24	Use electrical connectors that incorporate alignment key-ways to reduce incidents of damage due to improper engagement.
		EC-25	Use positive locking, quick disconnect electrical connectors to save man-hours, prevent foreign object damage (FOD) and decrease the chance of personal injury.
		EC-26	Avoid using identical electrical connectors in adjacent areas.
		ENG(G)-06	The distance between the engine and firewall should ensure the access envelopes to lines, fittings, wiring, and adjustments will accommodate the 75 percentile male hand.
		ENG(G)-10	Design attaching hardware for all mechanical engine-to-vehicle interfaces to be captive and with integral safeties.
		ENG(G)-20	Design all firewall fittings, connectors, and penetrations to be fully viewable and directly accessible to the maintainers.

Guidelines by Category (Cont'd)

Category No.	Category Title	Guideline No.	Guideline
3.01.04	Coaxial Connectors and Wave Guides	ENG-07	Plumbing and wiring spanning two or more engine modules should contain in-line disconnects to enhance and simplify engine modularization.
		ENG-25	All engine-to-airframe plumbing, wiring, and duct interfaces should be capable of being connected or disconnected by hand, should contain integral safety provisions, and should not require torquing.
		ENG-38	The characteristics of engine-to-vehicle interfaces coupled with the capabilities of electronic engine controls, should negate the necessity for making any type of engine rigging including maximum power, idle, and idle cut-off.
		ENG-39	Engine-to-vehicle plumbing quick disconnects should contain positive visual indication that the interface is fully seated and locked.
		ENG-47	Design the engine, including all accessories, plumbing, wiring, ducts, and mechanisms, to meet the same environmental protection and compatibility requirements as the host vehicle.
		LG-11	All microswitches, proximity switches, lights, sensors, etc. mounted to a strut should have individual interface connectors.
		LG-14	Wiring pigtailed requiring in-line splices should be avoided.
		LG-21	All interfaces from the airframe to the struts should be visible and accessible, and not require removal of airframe structure for access.
		MC-02	Proximity type switches used in landing gear design should meet a minimum of 200 volt-amperes to eliminate Electromagnetic Interference (EMI) or Radiation Hazard (RADHAD) problems. Wiring associated with the landing gear design should meet the same requirements.
		MC-06	Avoid the use of cotter pins, safety wire, safety clips, and similar devices to prevent maintenance-induced events leading to ground vehicle accidents or loss of air vehicles.
		MC-10	Locate, position, orient all plumbing and duct electrical connectors to prevent the need for sequential installation or removal.
		MC-12	In rare instances where a plumbing run contains complex form or geometry that would require removal of other plumbing or equipment for access, in-line connectors should be incorporated to maintain the integrity of other plumbing or equipment.
		MC-14	All plumbing and connectors containing liquids should be meniscus-free.
		TP-01	Where multiple connectors are located in close proximity, ensure (1) a minimum hand tool arc of 120 degrees can be maintained, and (2) stagger fittings to ensure firm coupling interface/hand tool interface can be accomplished without inducing damage to adjacent lines.
		TP-02	Locate Input/Output (I/O) test points and associated readouts in close proximity to each other so that one person can perform testing.
		TP-03	Protect test points against the environment and from induced contamination.
		W-01	Protect test points from outside signal generation.
		A-13	Hat section type structural stiffeners with sufficient cross sectional area should be considered as a routing tunnel for wiring and coax.
3.01.05	Control Rods, Cables, and Control Concept	BIT-06	Two-sided or two-surfaced access should not be required for access to equipment interfaces and hardpoints. The term two-sided infers top/bottom, left/right, front/back, or combinations thereof.
		BIT-09	Mission critical functions should be monitored by BIT.
		CONT-01	Use concurrent BIT to monitor system critical functions.
		CONT-02	Control rods should use Boyd or impedance type bolts (or equivalent) to eliminate the need for cotter pins or safety wire.
		CONT-03	Do not use metal control cables for vehicles that will operate in salt water or salt air environments.
		CONT-04	Use control rods rather than control cables for non-complex applications and non-complex routing within the vehicle.
		CONT-05	Use control cables rather than control rods for most complex applications.
		CONT-06	Route cables so that 100 percent of a cable will be viewable for inspection.
		CREW-04	Design all pulleys and brackets associated with cable installations so they are accessible by a 75 percentile male hand.
			Avoid wiring, coax, and plumbing penetrations through the floor of crew cabs, operators' compartments, crew stations, cockpits, and passenger compartments.

Guidelines by Category (Cont'd)

Category No.	Category Title	Guideline No.	Guideline
3.01.05	Control Rods, Cables, and Control Concept	ENG(G)-06	The distance between the engine and firewall should ensure the access envelopes to lines, fittings, wiring, and adjustments will accommodate the 75 percentile male hand.
		ENG(G)-10	Design attaching hardware for all mechanical engine-to-vehicle interfaces to be captive and with integral safeties.
		ENG(G)-20	Design all firewall fittings, connectors, and penetrations to be fully viewable and directly accessible to the maintainers.
		ENG-07	Plumbing and wiring spanning two or more engine modules should contain in-line disconnects to enhance and simplify engine modularization.
		ENG-10	On multi-engine air vehicles, the airframe-to-engine interfaces should be in identical positions or orientations for each engine cavity.
		ENG-25	All engine-to-airframe plumbing, wiring, and duct interfaces should be capable of being connected or disconnected by hand, should contain integral safety provisions, and should not require torquing.
		ENG-31	No rigging or calibration should be required subsequent to replacement of any engine-mounted component.
		ENG-38	The characteristics of engine-to-vehicle interfaces coupled with the capabilities of electronic engine controls, should negate the necessity for making any type of engine rigging including maximum power, idle, and idle cut-off.
		ENG-39	Engine-to-vehicle plumbing quick disconnects should contain positive visual indication that the interface is fully seated and locked.
		ENG-47	Design the engine, including all accessories, plumbing, wiring, ducts, and mechanisms, to meet the same environmental protection and compatibility requirements as the host vehicle.
		IN(V)-01	Design inlet door actuators and door actuation mechanisms so they not protrude into the air inlet flow field to eliminate FOD potential.
		LG-04	Do not use Beryllium and Beryllium base alloys in any location subject to wear or corrosive atmospheres or in installations where machining may be required.
		LG-05	All bolts or similar threaded means used as adjustable stops should be positively retained in the adjusted reference without reliance on jam nuts, cotter pins, or safety wire.
		LG-16	No portion of the landing gear rigging process should require support equipment type templates, gauges, or tools. Indexes, reference points, etc., should be an integral part of the landing gear/airframe design.
		MC-02	Avoid the use of cotter pins, safety wire, safety clips, and similar devices to prevent maintenance-induced events leading to ground vehicle accidents or loss of air vehicles.
		MC-06	Locate, position, orient all plumbing and duct electrical connectors to prevent the need for sequential installation or removal.
		MC-10	In rare instances where a plumbing run contains complex form or geometry that would require removal of other plumbing or equipment for access, in-line connectors should be incorporated to maintain the integrity of other plumbing or equipment.
		MC-14	Where multiple connectors are located in close proximity, ensure (1) a minimum hand tool arc of 120 degrees can be maintained, and (2) stagger fittings to ensure firm coupling interface/hand tool interface can be accomplished without inducing damage to adjacent lines.
		PYRO-27	Incorporate integral hoisting provisions at each weapon/store station to enable direct lift from the container or carrier to the attachment hardpoints.
		W-01	Hat section type structural stiffeners with sufficient cross sectional area should be considered as a routing tunnel for wiring and coax.
		A-07	Paint equipment bay and compartment interiors a high gloss white to maximize lighting reflectivity, visibility, and rapid leak detection capability.
3.02	Power	A-10	Provide a sufficient number of compartment fluid drains to ensure fluid drainage for varying aircraft static attitudes and varying terrain slopes for ground vehicles.
		A-11	Locate compartment electrical penetrations close to the access opening for ease of sight, probing, repair, and to eliminate fluid soaking, wicking, or contamination.
		A-12	Locate compartment electrical penetrations far enough from the access opening to prevent damage resulting from improper (over-length) panel fasteners.

Guidelines by Category (Cont'd)

Category No.	Category Title	Guideline No.	Guideline
3.02	Power	A-14	Do not locate nutplates or gang channels in inaccessible areas that would require extensive disassembly or equipment removal to gain access.
		A-15	Locate tie-down attachment points such that tie-down chains, straps, or cables do not prevent or restrict normal servicing, weapon loading, or safe/arm functions.
		BIT-05	Incorporate testability design features as an integral part of equipment preliminary design process.
		CBR-01	Orient all vehicle liquid servicing fittings to ensure fluids will not come in contact with protective garb during connect/disconnect activities.
		CBR-02	Ensure vehicle overboard passive liquid drains are clearly marked or visible to enable personnel to remain clear of area.
		CONT-01	Control rods should use Boyd or impedance type bolts (or equivalent) to eliminate the need for cotter pins or safety wire.
		CONT-02	Do not use metal control cables for vehicles that will operate in salt water or salt air environments.
		CONT-03	Use control rods rather than control cables for non-complex applications and non-complex routing within the vehicle.
		CONT-04	Use control cables rather than control rods for most complex applications.
		CONT-05	Route cables so that 100 percent of a cable will be viewable for inspection.
		CONT-06	Design all pulleys and brackets associated with cable installations so they are accessible by a 75 percentile male hand.
		ENG(G)-01	Provide access to all engine mounts for ground vehicles so that hoisting or crawling under the vehicle is not required.
		ENG(G)-02	Use torque-limiting bolts or torque washers as engine mount attaching hardware to eliminate the need for torque wrenches.
		ENG(G)-03	Design hard points for hoisting or positioning the engine during installation and removal to be integral to the engine and capable of hoisting and supporting a fully-built-up engine package.
		ENG(G)-04	Do not use downward engine removal concepts that require jacking or hoisting of the ground vehicle.
		ENG(G)-05	Use concepts for removing ground vehicle engines from the front, rear, or side rather than from overhead (using hoisting).
		ENG(G)-06	The distance between the engine and firewall should ensure the access envelopes to lines, fittings, wiring, and adjustments will accommodate the 75 percentile male hand.
		ENG(G)-07	The distance between the cooling fan and radiator core should ensure that access envelopes will not require removal of the core.
		ENG(G)-08	The interface of the engine assembly to the engine compartment and structure should be designed to ensure all spark plugs, glo-plugs, and igniters can be replaced within 30 minutes elapsed time.
		ENG(G)-10	Design attaching hardware for all mechanical engine-to-vehicle interfaces to be captive and with integral safeties.
		ENG(G)-11	Use "torq-set" type clamps or equivalent in all cooling system hose interfaces to eliminate torque wrenches and the potential for error.
		ENG(G)-12	Provide a clear and viewable access envelope to fuel and oil filters.
		ENG(G)-13	Locate fuel filters to ensure no safety hazard will exist due to residual fuel during filter change.
		ENG(G)-14	Access envelopes to fuel and oil filters should not be in close proximity to exhaust manifolds or cooling system return lines.
		ENG(G)-15	Any single drive belt (excluding timing belts) should be capable of replacement within 30 minutes elapsed time
		ENG(G)-16	Do not locate batteries in the engine compartment. In those instances where this is not possible: - The battery support structure should be of a material that is impervious to acid leakage or boil-over. - The battery support structure should serve as a scupper to collect and direct the acid out of the engine compartment.
		ENG(G)-17	Install simple, lightweight shields over cooling system return lines to protect personnel from hose or line blowout during maintenance.

Guidelines by Category (Cont'd)

Category No.	Category Title	Guideline No.	Guideline
3.02	Power	ENG(G)-18	Incorporate appropriate sensors to enhance the diagnostic and prognostic capabilities for the following: <ul style="list-style-type: none"> - Fuel filter bypass - Oil temperature - Oil pressure - Oil filter bypass - Oil cooler bypass valve position - Oil level - Oil return line particle count
		ENG(G)-19	Paint engine compartments gloss white to enhance light reflectivity and enhance fluid leak detection.
		ENG(G)-20	Design all firewall fittings, connectors, and penetrations to be fully viewable and directly accessible to the maintainers.
		ENG-01	All facets of engine design should take advantage of Electrostatic Engine Monitoring Systems (EEMS) and Inductive Debris Monitoring (IDM) toward achievement of on-condition maintenance and engine health monitoring.
		ENG-02	Each different component of rotating machinery should contain different tracer elements to enhance EEMS and IDM isolation and tracking of wear.
		ENG-03	Digital electronic controls, fully automatic digital electronic controls, and similar concepts should contain the highest degree of BIT and diagnostics commensurate with affordability, operation and maintenance, and life cycle costs as appropriate.
		ENG-04	The engine and engine-mounted gear box should have individual oil supplies to ensure wear or failures in one will not contaminate or fail the other.
		ENG-05	All engine-mounted air and fluid lines should be located next to the fan case, engine case, or full-length fan duct to ensure quick and simple replacement of accessories and components.
		ENG-06	All other engine surfaces and engine-mounted accessory surfaces should be free of pockets, channels, and bathtubs that could trap and retain fluids.
		ENG-07	Plumbing and wiring spanning two or more engine modules should contain in-line disconnects to enhance and simplify engine modularization.
		ENG-08	Use V-band clamps to mount accessories to engine-mounted gear boxes.
		ENG-09	On multi-engine air vehicles, the engines should be capable of being installed in any engine cavity without need for reconfiguration.
		ENG-10	On multi-engine air vehicles, the airframe-to-engine interfaces should be in identical positions or orientations for each engine cavity.
		ENG-11	Control-by-wire or control-by-light throttling concepts should take precedence over mechanical controls.
		ENG-12	All engine-mounted accessories must be capable of being removed and installed through the available airframe access openings.
		ENG-13	Engine oil systems should contain on-board spectrometric oil analysis devices located on the engine.
		ENG-14	Coring of engine gear box cases and housings to provide for fuel heat sink routing should take precedence over dedicated fuel or oil heat exchangers.
		ENG-15	Engine removal for aircraft intended to be operated off carriers should be accomplished within the shadow of the aircraft.
		ENG-16	Aircraft jacking should not be required for engine removal.
		ENG-17	Aft engine removal should be an acceptable alternative for USAF aircraft.
		ENG-18	For either downward or aft engine removal, it should be possible to maintain control of the engine on all axis during the entire removal and installation process.
		ENG-19	The minimum clearance between engine and airframe should be 1 inch, including removal and installation.
		ENG-20	Do not locate equipment or components in the engine cavity except for those components associated with the engine or engine installation.
		ENG-21	Do not locate equipment or components in the engine bay cavity in a manner that would require removal or repositioning for engine removal.

Guidelines by Category (Cont'd)

Category No.	Category Title	Guideline No.	Guideline
3.02	Power	ENG-22	The engine cavity structure should be capable of withstanding a 2000-degree Fahrenheit fire for 10 minutes without jeopardizing loss of the vehicle.
		ENG-23	All engine borescope provisions should be accessible with the engine installed and hooked up.
		ENG-24	Replacement of all ignitors should be possible with the engine installed.
		ENG-25	All engine-to-airframe plumbing, wiring, and duct interfaces should be capable of being connected or disconnected by hand, should contain integral safety provisions, and should not require torquing.
		ENG-26	Locate and position engine overheat and fire warning sensors so that damage cannot occur during engine maintenance or replacement.
		ENG-27	No rigging or calibration should be required following engine replacement.
		ENG-28	No engine operational start and checkout should be required following engine replacement.
		ENG-29	No functional check flight should be required following engine change. On twin engine aircraft where both engines were changed simultaneously, a functional test flight is permissible.
		ENG-30	It should not be necessary to close or reinstall engine access doors for engine ground operation up to and including military power.
		ENG-31	No rigging or calibration should be required subsequent to replacement of any engine-mounted component.
		ENG-32	Design the engine fuel controls and electronic controllers so that no manual fuel grade adjustments are required.
		ENG-33	Engine access doors and panels and their integral support struts should be capable of withstanding 60 MPH winds in the opened position.
		ENG-34	Identification plates on the engine and all engine-mounted components should be viewable with the engine installed and engine access doors opened.
		ENG-35	No time-change components or scheduled actions should be planned solely to protect component integrity or reliability.
		ENG-36	All borescope mechanisms should have positive integral locking features.
		ENG-37	Gravity type servicing fittings, covers, and caps should have integral locking features, openable by hand, and contain a cable or chain to prevent loss or dropping.
		ENG-38	The characteristics of engine-to-vehicle interfaces coupled with the capabilities of electronic engine controls, should negate the necessity for making any type of engine rigging including maximum power, idle, and idle cut-off.
		ENG-39	Engine-to-vehicle plumbing quick disconnects should contain positive visual indication that the interface is fully seated and locked.
		ENG-40	Design of electronic engine controls should be such that no single failure of a sub-component within can result in over speed, over temperature, stagnation, or shut-down.
		ENG-41	Use captive fasteners containing self-locking features to attach the nose dome to the engine face. The fasteners should be fully viewable during engine face FOD inspections.
		ENG-42	Attach engine-to-inlet duct interface seals to the vehicle so they can be left in place during engine removal.
		ENG-43	Design engine-to-inlet duct seal so the interface is automatic during engine installation without needing any form of alignment, adjustment, or mechanical attachment interface.
		ENG-44	Select engine-to-inlet duct seal material to ensure seal life is sufficient for the life of the vehicle.
		ENG-45	Provide remote servicing points accessible from the ground to service engine accessories mounted on top of the engine (e.g., oil tanks, gear boxes, generators, etc.) to eliminate climbing upon or atop the host vehicle.
		ENG-46	Design the basic engine and engine-mounted accessory interface so that no fluid traps or bathtubs exist regardless of engine-mounted accessory location.
		ENG-47	Design the engine, including all accessories, plumbing, wiring, ducts, and mechanisms, to meet the same environmental protection and compatibility requirements as the host vehicle.
		ENG-48	Do not drain or dump residual fuel in the engine fuel control/manifold overboard. When it is not possible to follow this guideline, route the fuel to an engine-mounted collector tank capable of retaining fuel from two shutdowns.
		ENG-49	Design engine fuel and oil filters with integral locking features so they can be installed and removed by hand, and require no torquing.

Guidelines by Category (Cont'd)

Category No.	Category Title	Guideline No.	Guideline
3.02	Power		
		ENG-50	Design engine fuel and oil filter delta pressure indicators so they can be reset only from within the filter housing.
		ENG-51	Provide engine fuel and oil filters with anti-surge protection to ensure false delta pressure indications do not occur.
		ENG-52	Incorporate provisions to enable very slow rotation of the fan, compressor, and turbine during borescope inspections.
		ENG-53	Design magnetic chip detectors to ensure that oil shut-off will occur as the detector is being removed for visual inspection.
		ENG-54	Incorporate provisions for fuzz burn-off in magnetic chip detectors.
		ENV-05	For airborne vehicles, materials and all finishes with the engine inlet should be durable against hammer shock and compressor stalls.
		ENV-06	For ground vehicles, the finishes should be compatible with and durable against all rain, hail, sleet, snow, and ice conditions experienced in all intended operational environments.
		ENV-07	The finishes and surfaces should be capable of low velocity impact (LVI) of 10 foot-pounds with no visual or detectable damage with a design goal of 30 foot-pounds.
		EXH-01	Treatments required for engine hot sections and exhaust areas should not require scheduled removals for the purposes of recoating.
		EXH-02	High temperature exhaust patterns should flow away from or be directed away from treated surrounding structure, coatings, or finishes.
		EXTING-01	Use extinguishing concepts dedicated to each individual fire zone in preference to manifold systems operating from a central source.
		EXTING-02	Design sealed extinguishing agent containers with an integral pressure/volume gage and a pressure-sensing transmitter for remote read-out.
		EXTING-03	Keep each individual fire zone over-temperature/fire warning system separate from those in other fire zones.
		EXTING-04	Design individual fire zone over-temperature/fire warning system to be fully BIT capable (the BIT concept should permit both initiated and periodic BIT).
		EXTING-05	Route and locate all tube, wire, and plumbing interfaces in a manner that prevents induced damage during maintenance.
		HOOK-06	Avoid the need to remove the tail hook to facilitate engine access or removal.
		HYD-09	Provide hydraulic devices used in critical applications with integral 5 micron filtering.
		IN(V)-01	Design inlet door actuators and door actuation mechanisms so they not protrude into the air inlet flow field to eliminate FOD potential.
		IN(V)-02	Do not use loose structural fasteners in the access area to inlet door actuators and mechanisms. Where this guideline cannot be followed, design the actuator door to be accessible only when the inlet doors are fully closed.
		IN(V)-03	For engine inlet bellmouth fairings, use methods of retention other than fasteners. Latches may be considered as an acceptable alternative only if latch-to-panel retention is from the inner mold line.
		IN(V)-04	Design inlet doors and inlet bellmouth fairings to be fully interchangeable to eliminate the need to cut, file, or trim at the engine face.
		IN(V)-05	Locate the inlet duct edge a minimum of 60 inches from the cockpit or crew station to eliminate restricting engine operation to canopy-closed conditions.
		IN(V)-06	Use captive fasteners on all access doors forward of the inlet to significantly reduce engine FOD potential.
		IN(V)-07	Ensure that no ground safety pins or streamers are used forward of the inlet or within a 3-foot radius aft of the inlet.
		IN(V)-08	Incorporate an inlet closure door sealing concept that prevents entry of fluid, dust, or sand across the entire airborne and ground environment spectrum.
		IN-01	Low Observable (LO) engine face frames should be within 10 inches of the first stage fan or compressor blades.
		IN-02	Openings throughout the engine face frame should be sufficient to perform a 100% FOD inspection of the engine face.
		IN-03	Openings throughout the engine face frame should be sufficient to permit minor blending or repair of FOD without removing the engine.
		IN-04	For frames not integral with the engine, frame removal should be achievable from the engine cavity.
		IN-05	Both integral and remote engine front frames should be interchangeable.

Guidelines by Category (Cont'd)

Category No.	Category Title	Guideline No.	Guideline
3.02	Power	IN-06	Front frame anti-ice and de-ice provisions should give preference to engine hot bleed air.
		LG-04	Do not use Beryllium and Beryllium base alloys in any location subject to wear or corrosive atmospheres or in installations where machining may be required.
		LG-05	All bolts or similar threaded means used as adjustable stops should be positively retained in the adjusted reference without reliance on jam nuts, cotter pins, or safety wire.
		MC-01	All clamps should contain torque-set or torque-limiting connections to prevent clamp or component failure due to over-torque. Clamp installation call outs should not depend on special tools to establish the required torque values.
		MC-02	Avoid the use of cotter pins, safety wire, safety clips, and similar devices to prevent maintenance-induced events leading to ground vehicle accidents or loss of air vehicles.
		MC-03	All tubing connections and interfaces should use rosan/dynatube (or equivalent) to (1) enable connect or disconnect with one hand, one tool, (2) eliminate the need to safety the connection, (3) provide a superior seal, and (4) negate need to reposition line(s) during component replacement.
		MC-04	No trombone type, flared tube type, or piloted line type interfaces should be used to avoid the need for removal or repositioning during equipment removal.
		MC-05	Avoid potential foreign object traps during manufacturing or operational maintenance by eliminating vertical penetrations of plumbing/fittings into tanks, compartments, or cells
		MC-06	Locate, position, orient all plumbing and duct electrical connectors to prevent the need for sequential installation or removal.
		MC-09	All plumbing connections and fittings used for fuel systems should contain integral bonding features to eliminate the need for bonding clamps or jumper cables.
		MC-10	In rare instances where a plumbing run contains complex form or geometry that would require removal of other plumbing or equipment for access, in-line connectors should be incorporated to maintain the integrity of other plumbing or equipment.
		MC-11	No subsystem plumbing, equipment, or wiring should use a tank, cell, or compartment containing liquids as a means for routing or penetration simplicity during manufacture.
		MC-12	All plumbing and connectors containing liquids should be meniscus-free.
		MC-13	In instances where plumbing or connector interfaces cannot or are not keyed for a specific orientation, all identification, markings, cautions, and directions should be placed 360 degrees around the tube or duct.
		MC-14	Where multiple connectors are located in close proximity, ensure (1) a minimum hand tool arc of 120 degrees can be maintained, and (2) stagger fittings to ensure firm coupling interface/hand tool interface can be accomplished without inducing damage to adjacent lines.
		MC-15	Route, orient, and position plumbing, wiring, ducts, and connectors sufficiently away from the outer surface of the vehicle to preclude induced damage due to minor dents, drill bits during repair, etc. Minimum rule of thumb is 1" away from the inner surface and 1" below a plate nut channel.
		TCR-01	For each transmission, clutch, or rotor, provide a dedicated lubricating oil supply tank and system that is not shared with any other oil lubricating system.
		TCR-02	Provide each dedicated oil supply system with a separate servicing port/interface, pressure gauging, and quantity gauging system as applicable.
		TCR-03	Use a singular gage capable of reading pressures or quantities from two or more lubricating systems in preference to individual gages.
		TCR-04	Provide each dedicated system with an on-board spectrometric oil analysis program capability, separate oil filter, and separate oil, fuel, or air heat exchanger capability.
		TCR-05	Use the item's self-contained oil system to provide drive/interface spline lubrication, if required.
		TCR-06	In complex units, use different tracer elements in multiple gears, plates, discs, etc., so the source of wear can be easily identified by spectrometric oil analysis monitoring units.
		TCR-07	Design mechanical interfaces to transmissions, clutches, and rotors so that the respective unit can be replaced without the need for rigging.

Guidelines by Category (Cont'd)

Category No.	Category Title	Guideline No.	Guideline
3.02	Power	TCR-08	Incorporate vibration pick-up sensors to isolate the respective unit from other potential sources of vibration, and to enhance the prognostic potential for monitoring equipment health.
3.02.01	Engines (Gasoline and Diesel)	A-04	Use stiffening beads in lieu of flanges to the maximum extent to enhance compartment volume and simplify repairs.
		A-05	Stiffening beads should have the convex surface toward the compartment to eliminate fluid traps.
		A-06	Keep all machined compartment frames, webs, and closure panels to a constant thickness (e.g., not stepped or tapered) to ease simplicity of fluid or electrical penetrations and ease and simplicity of structural repair.
		A-08	Hardpoints (structural attachment and load bearing areas) within a compartment to assist in equipment mounting or support should not be integral with the machined part. Hardpoints should be parasitic to enable quick repair in case of wear or damage in lieu of precise ream/bush repair typical of machined hardpoints.
		A-09	Plumbing penetrations into a compartment should not be on a vertical axis due to difficulty in making or breaking vertically-oriented connections. When compartment access is from the bottom, vertically-oriented connections can allow fluid to leak onto the maintainer. When access is from the top, such connections can allow foreign matter to enter the line. Use horizontal penetrations whenever possible.
		A-13	Any heat or temperature sensitive structure within a compartment should contain heat-sensitive tape or appropriate heat sensor for easy indication of over-temperature excursions.
		A-18	Two-sided or two-surfaced access should not be required for access to equipment interfaces and hardpoints. The term two-sided infers top/bottom, left/right, front/back, or combinations thereof.
		BIT-01	Use transparent windows, quick-opening covers, or openings without any cover to permit quick visual inspections where needed.
		BIT-02	During design of the BIT, use worst-case stress analysis to ensure that any circuit failures induced by temperature extremes, tolerance build-up, power supply variations, and combinations thereof are identified.
		BIT-03	Ensure that BIT system thresholds are consistent with those across the system, subsystem, item, module, and piece-part levels to prevent excessive numbers of Cannot Duplicate (CND) and Retest OK (RTOK) events from occurring.
		BIT-04	The degree of BIT required or proposed should be based on the respective failure rates and the appropriate FMECA at all equipment indenture levels.
		BIT-05	Limit the amount of data that is recorded to a manageable size by:
		BIT-06	- Limiting the number of signals that are monitored
		BIT-09	- Limiting the maximum sampling rate
		BIT-20	- Reducing the time span over which data is accumulated
		BIT-26	- Restricting the type of data accumulated
		C-01	Incorporate testability design features as an integral part of equipment preliminary design process.
		C-02	Mission critical functions should be monitored by BIT.
		CBR-01	Use concurrent BIT to monitor system critical functions.
		CONT-01	The BIT should be mechanized so that when a piece of equipment is not installed in a subsystem or the product, a failure will not be indicated.
		CONT-02	Locate routinely used test points so they are accessible without removing or disassembling other equipment
		CONT-03	Avoid swivel type connectors and fittings for air, fuel, or hydraulic line interfaces due to their history of low reliability.
		CONT-04	Provide spacing between parallel plumbing runs so that in-line couplings can be replaced without removing lines or disconnecting any line support devices.
		CONT-05	Orient all vehicle liquid servicing fittings to ensure fluids will not come in contact with protective garb during connect/disconnect activities.
		CONT-06	Ensure vehicle overboard passive liquid drains are clearly marked or visible to enable personnel to remain clear of area.
		CONT-07	Control rods should use Boyd or impedance type bolts (or equivalent) to eliminate the need for cotter pins or safety wire.
		CONT-08	Do not use metal control cables for vehicles that will operate in salt water or salt air environments.
		CONT-09	Use control rods rather than control cables for non-complex applications and non-complex routing within the vehicle.
		CONT-10	Use control cables rather than control rods for most complex applications.

Guidelines by Category (Cont'd)

Category No.	Category Title	Guideline No.	Guideline
3.02.01	Engines (Gasoline and Diesel)		
		CONT-05	Route cables so that 100 percent of a cable will be viewable for inspection.
		CONT-06	Design all pulleys and brackets associated with cable installations so they are accessible by a 75 percentile male hand.
		ENG(G)-01	Provide access to all engine mounts for ground vehicles so that hoisting or crawling under the vehicle is not required.
		ENG(G)-02	Use torque-limiting bolts or torque washers as engine mount attaching hardware to eliminate the need for torque wrenches.
		ENG(G)-03	Design hard points for hoisting or positioning the engine during installation and removal to be integral to the engine and capable of hoisting and supporting a fully-built-up engine package.
		ENG(G)-04	Do not use downward engine removal concepts that require jacking or hoisting of the ground vehicle.
		ENG(G)-05	Use concepts for removing ground vehicle engines from the front, rear, or side rather than from overhead (using hoisting).
		ENG(G)-06	The distance between the engine and firewall should ensure the access envelopes to lines, fittings, wiring, and adjustments will accommodate the 75 percentile male hand.
		ENG(G)-07	The distance between the cooling fan and radiator core should ensure that access envelopes will not require removal of the core.
		ENG(G)-08	The interface of the engine assembly to the engine compartment and structure should be designed to ensure all spark plugs, glow-plugs, and igniters can be replaced within 30 minutes elapsed time.
		ENG(G)-10	Design attaching hardware for all mechanical engine-to-vehicle interfaces to be captive and with integral safeties.
		ENG(G)-11	Use "torq-set" type clamps or equivalent in all cooling system hose interfaces to eliminate torque wrenches and the potential for error.
		ENG(G)-12	Provide a clear and viewable access envelope to fuel and oil filters.
		ENG(G)-13	Locate fuel filters to ensure no safety hazard will exist due to residual fuel during filter change.
		ENG(G)-14	Access envelopes to fuel and oil filters should not be in close proximity to exhaust manifolds or cooling system return lines.
		ENG(G)-15	Any single drive belt (excluding timing belts) should be capable of replacement within 30 minutes elapsed time
		ENG(G)-16	Do not locate batteries in the engine compartment. In those instances where this is not possible:
			- The battery support structure should be of a material that is impervious to acid leakage or boil-over.
			- The battery support structure should serve as a scupper to collect and direct the acid out of the engine compartment.
		ENG(G)-17	Install simple, lightweight shields over cooling system return lines to protect personnel from hose or line blowout during maintenance.
		ENG(G)-18	Incorporate appropriate sensors to enhance the diagnostic and prognostic capabilities for the following: <ul style="list-style-type: none"> - Oil temperature - Oil pressure - Oil filter bypass - Oil cooler bypass valve position - Oil level - Oil return line particle count
			<ul style="list-style-type: none"> - Fuel filter bypass - Coolant pressure - Coolant level - Coolant temperature - Vibration pickups - Chip detector
		ENG(G)-19	Paint engine compartments gloss white to enhance light reflectivity and enhance fluid leak detection.
		ENG(G)-20	Design all firewall fittings, connectors, and penetrations to be fully viewable and directly accessible to the maintainers.
		ENV-05	For airborne vehicles, materials and all finishes with the engine inlet should be durable against hammer shock and compressor stalls.
		ENV-06	For ground vehicles, the finishes should be compatible with and durable against all rain, hail, sleet, snow, and ice conditions experienced in all intended operational environments.
		EXH-01	Treatments required for engine hot sections and exhaust areas should not require scheduled removals for the purposes of recoating.
		EXH-02	High temperature exhaust patterns should flow away from or be directed away from treated surrounding structure, coatings, or finishes.

Guidelines by Category (Cont'd)

Category No.	Category Title	Guideline No.	Guideline
3.02.01	Engines (Gasoline and Diesel)	EXTING-01	Use extinguishing concepts dedicated to each individual fire zone in preference to manifold systems operating from a central source.
		EXTING-02	Design sealed extinguishing agent containers with an integral pressure/volume gage and a pressure-sensing transmitter for remote read-out.
		EXTING-03	Keep each individual fire zone over-temperature/fire warning system separate from those in other fire zones.
		EXTING-04	Design individual fire zone over-temperature/fire warning system to be fully BIT capable (the BIT concept should permit both initiated and periodic BIT).
		EXTING-05	Route and locate all tube, wire, and plumbing interfaces in a manner that prevents induced damage during maintenance.
		GBD-01	Guidelines for transmissions, clutches, and rotors apply.
		GBD-02	Use the host gear box lubricating system to provide lubrication of the drive shaft spline.
		GBD-03	Design drive shafts using the "blind spline" concept to ensure correct mating of the shaft to the gear box.
		GBD-04	Design drive shafts with a simple, light-weight cover to protect personnel.
		GBD-05	Design drive shaft covers with a hole or slot type opening to prevent the masking of leakage or damage.
		HOOK-06	Avoid the need to remove the tail hook to facilitate engine access or removal.
		LG-04	Do not use Beryllium and Beryllium base alloys in any location subject to wear or corrosive atmospheres or in installations where machining may be required.
		LG-05	All bolts or similar threaded means used as adjustable stops should be positively retained in the adjusted reference without reliance on jam nuts, cotter pins, or safety wire.
		MC-01	All clamps should contain torque-set or torque-limiting connections to prevent clamp or component failure due to over-torque. Clamp installation call outs should not depend on special tools to establish the required torque values.
		MC-02	Avoid the use of cotter pins, safety wire, safety clips, and similar devices to prevent maintenance-induced events leading to ground vehicle accidents or loss of air vehicles.
		MC-03	All tubing connections and interfaces should use rosan/dynatube (or equivalent) to (1) enable connect or disconnect with one hand, one tool, (2) eliminate the need to safety the connection, (3) provide a superior seal, and (4) negate need to reposition line(s) during component replacement.
		MC-04	No trombone type, flared tube type, or piloted line type interfaces should be used to avoid the need for removal or repositioning during equipment removal.
		MC-05	Avoid potential foreign object traps during manufacturing or operational maintenance by eliminating vertical penetrations of plumbing/fittings into tanks, compartments, or cells
		MC-06	Locate, position, orient all plumbing and duct electrical connectors to prevent the need for sequential installation or removal.
		MC-09	All plumbing connections and fittings used for fuel systems should contain integral bonding features to eliminate the need for bonding clamps or jumper cables.
		MC-10	In rare instances where a plumbing run contains complex form or geometry that would require removal of other plumbing or equipment for access, in-line connectors should be incorporated to maintain the integrity of other plumbing or equipment.
		MC-11	No subsystem plumbing, equipment, or wiring should use a tank, cell, or compartment containing liquids as a means for routing or penetration simplicity during manufacture.
		MC-12	All plumbing and connectors containing liquids should be meniscus-free.
		MC-13	In instances where plumbing or connector interfaces cannot or are not keyed for a specific orientation, all identification, markings, cautions, and directions should be placed 360 degrees around the tube or duct.
		MC-14	Where multiple connectors are located in close proximity, ensure (1) a minimum hand tool arc of 120 degrees can be maintained, and (2) stagger fittings to ensure firm coupling interface/hand tool interface can be accomplished without inducing damage to adjacent lines.
		MP-01	Avoid the use epoxies to mount parts on repairable modules because they make repair extremely difficult.

Guidelines by Category (Cont'd)

Category No.	Category Title	Guideline No.	Guideline
3.02.01	Engines (Gasoline and Diesel)	MP-02	Use a unique identification (ID) resistor incorporated in each system module to verify that the proper module is mounted on ATE.
		MP-03	Design modules so that lengthy warm-up times, special coding and air purity levels, and similar constraints are not necessary.
		TCR-01	For each transmission, clutch, or rotor, provide a dedicated lubricating oil supply tank and system that is not shared with any other oil lubricating system.
		TCR-02	Provide each dedicated oil supply system with a separate servicing port/interface, pressure gauging, and quantity gauging system as applicable.
		TCR-03	Use a singular gage capable of reading pressures or quantities from two or more lubricating systems in preference to individual gages.
		TCR-04	Provide each dedicated system with an on-board spectrometric oil analysis program capability, separate oil filter, and separate oil, fuel, or air heat exchanger capability.
		TCR-05	Use the item's self-contained oil system to provide drive/interface spline lubrication, if required.
		TCR-06	In complex units, use different tracer elements in multiple gears, plates, discs, etc., so the source of wear can be easily identified by spectrometric oil analysis monitoring units.
		TCR-07	Design mechanical interfaces to transmissions, clutches, and rotors so that the respective unit can be replaced without the need for rigging.
		TCR-08	Incorporate vibration pick-up sensors to isolate the respective unit from other potential sources of vibration, and to enhance the prognostic potential for monitoring equipment health.
3.02.02	Engines (Turbine-driven)	A-04	Use stiffening beads in lieu of flanges to the maximum extent to enhance compartment volume and simplify repairs. Stiffening beads should have the convex surface toward the compartment to eliminate fluid traps.
		A-05	Keep all machined compartment frames, webs, and closure panels to a constant thickness (e.g., not stepped or tapered) to ease simplicity of fluid or electrical penetrations and ease and simplicity of structural repair.
		A-06	Hardpoints (structural attachment and load bearing areas) within a compartment to assist in equipment mounting or support should not be integral with the machined part. Hardpoints should be parasitic to enable quick repair in case of wear or damage in lieu of precise ream/bush repair typical of machined hardpoints.
		A-08	Plumbing penetrations into a compartment should not be on a vertical axis due to difficulty in making or breaking vertically-oriented connections. When compartment access is from the bottom, vertically-oriented connections can allow fluid to leak onto the maintainer. When access is from the top, such connections can allow foreign matter to enter the line. Use horizontal penetrations whenever possible.
		A-09	Any heat or temperature sensitive structure within a compartment should contain heat-sensitive tape or appropriate heat sensor for easy indication of over-temperature excursions.
		A-13	Two-sided or two-surfaced access should not be required for access to equipment interfaces and hardpoints. The term two-sided infers top/bottom, left/right, front/back, or combinations thereof.
		A-18	Use transparent windows, quick-opening covers, or openings without any cover to permit quick visual inspections where needed.
		BIT-01	During design of the BIT, use worst-case stress analysis to ensure that any circuit failures induced by temperature extremes, tolerance build-up, power supply variations, and combinations thereof are identified.
		BIT-02	Ensure that BIT system thresholds are consistent with those across the system, subsystem, item, module, and piece-part levels to prevent excessive numbers of Cannot Duplicate (CND) and Retest OK (RTOK) events from occurring.
		BIT-03	The degree of BIT required or proposed should be based on the respective failure rates and the appropriate FMECA at all equipment indenture levels.
		BIT-04	Limit the amount of data that is recorded to a manageable size by: <ul style="list-style-type: none"> - Limiting the number of signals that are monitored - Limiting the maximum sampling rate - Reducing the time span over which data is accumulated - Restricting the type of data accumulated

Guidelines by Category (Cont'd)

Category No.	Category Title	Guideline No.	Guideline
3.02.02	Engines (Turbine-driven)	BIT-05	Incorporate testability design features as an integral part of equipment preliminary design process.
		BIT-06	Mission critical functions should be monitored by BIT.
		BIT-09	Use concurrent BIT to monitor system critical functions.
		BIT-20	The BIT should be mechanized so that when a piece of equipment is not installed in a subsystem or the product, a failure will not be indicated.
		BIT-26	Locate routinely used test points so they are accessible without removing or disassembling other equipment
		C-01	Avoid swivel type connectors and fittings for air, fuel, or hydraulic line interfaces due to their history of low reliability.
		C-02	Provide spacing between parallel plumbing runs so that in-line couplings can be replaced without removing lines or disconnecting any line support devices.
		CBR-01	Orient all vehicle liquid servicing fittings to ensure fluids will not come in contact with protective garb during connect/disconnect activities.
		CBR-02	Ensure vehicle overboard passive liquid drains are clearly marked or visible to enable personnel to remain clear of area.
		CONT-01	Control rods should use Boyd or impedance type bolts (or equivalent) to eliminate the need for cotter pins or safety wire.
		CONT-02	Do not use metal control cables for vehicles that will operate in salt water or salt air environments.
		CONT-03	Use control rods rather than control cables for non-complex applications and non-complex routing within the vehicle.
		CONT-04	Use control cables rather than control rods for most complex applications.
		CONT-05	Route cables so that 100 percent of a cable will be viewable for inspection.
		CONT-06	Design all pulleys and brackets associated with cable installations so they are accessible by a 75 percentile male hand.
		ENG-01	All facets of engine design should take advantage of Electrostatic Engine Monitoring Systems (EEMS) and Inductive Debris Monitoring (IDM) toward achievement of on-condition maintenance and engine health monitoring.
		ENG-02	Each different component of rotating machinery should contain different tracer elements to enhance EEMS and IDM isolation and tracking of wear.
		ENG-03	Digital electronic controls, fully automatic digital electronic controls, and similar concepts should contain the highest degree of BIT and diagnostics commensurate with affordability, operation and maintenance, and life cycle costs as appropriate.
		ENG-04	The engine and engine-mounted gear box should have individual oil supplies to ensure wear or failures in one will not contaminate or fail the other.
		ENG-05	All engine-mounted air and fluid lines should be located next to the fan case, engine case, or full-length fan duct to ensure quick and simple replacement of accessories and components.
		ENG-06	All other engine surfaces and engine-mounted accessory surfaces should be free of pockets, channels, and bathtubs that could trap and retain fluids.
		ENG-07	Plumbing and wiring spanning two or more engine modules should contain in-line disconnects to enhance and simplify engine modularization.
		ENG-08	Use V-band clamps to mount accessories to engine-mounted gear boxes.
		ENG-09	On multi-engine air vehicles, the engines should be capable of being installed in any engine cavity without need for reconfiguration.
		ENG-10	On multi-engine air vehicles, the airframe-to-engine interfaces should be in identical positions or orientations for each engine cavity.
		ENG-11	Control-by-wire or control-by-light throttling concepts should take precedence over mechanical controls.
		ENG-12	All engine-mounted accessories must be capable of being removed and installed through the available airframe access openings.
		ENG-13	Engine oil systems should contain on-board spectrometric oil analysis devices located on the engine.
		ENG-14	Coring of engine gear box cases and housings to provide for fuel heat sink routing should take precedence over dedicated fuel or oil heat exchangers.
		ENG-15	Engine removal for aircraft intended to be operated off carriers should be accomplished within the shadow of the aircraft.

MIL-HDBK-470A

APPENDIX C

Guidelines by Category (Cont'd)

Category No.	Category Title	Guideline No.	Guideline
3.02.02	Engines (Turbine-driven)	ENG-16	Aircraft jacking should not be required for engine removal.
		ENG-17	Aft engine removal should be an acceptable alternative for USAF aircraft.
		ENG-18	For either downward or aft engine removal, it should be possible to maintain control of the engine on all axis during the entire removal and installation process.
		ENG-19	The minimum clearance between engine and airframe should be 1 inch, including removal and installation.
		ENG-20	Do not locate equipment or components in the engine cavity except for those components associated with the engine or engine installation.
		ENG-21	Do not locate equipment or components in the engine bay cavity in a manner that would require removal or repositioning for engine removal.
		ENG-22	The engine cavity structure should be capable of withstanding a 2000-degree Fahrenheit fire for 10 minutes without jeopardizing loss of the vehicle.
		ENG-23	All engine borescope provisions should be accessible with the engine installed and hooked up.
		ENG-24	Replacement of all ignitors should be possible with the engine installed.
		ENG-25	All engine-to-airframe plumbing, wiring, and duct interfaces should be capable of being connected or disconnected by hand, should contain integral safety provisions, and should not require torquing.
		ENG-26	Locate and position engine overheat and fire warning sensors so that damage cannot occur during engine maintenance or replacement.
		ENG-27	No rigging or calibration should be required following engine replacement.
		ENG-28	No engine operational start and checkout should be required following engine replacement.
		ENG-29	No functional check flight should be required following engine change. On twin engine aircraft where both engines were changed simultaneously, a functional test flight is permissible.
		ENG-30	It should not be necessary to close or reinstall engine access doors for engine ground operation up to and including military power.
		ENG-31	No rigging or calibration should be required subsequent to replacement of any engine-mounted component.
		ENG-32	Design the engine fuel controls and electronic controllers so that no manual fuel grade adjustments are required.
		ENG-33	Engine access doors and panels and their integral support struts should be capable of withstanding 60 MPH winds in the opened position.
		ENG-34	Identification plates on the engine and all engine-mounted components should be viewable with the engine installed and engine access doors opened.
		ENG-35	No time-change components or scheduled actions should be planned solely to protect component integrity or reliability.
		ENG-36	All borescope mechanisms should have positive integral locking features.
		ENG-37	Gravity type servicing fittings, covers, and caps should have integral locking features, openable by hand, and contain a cable or chain to prevent loss or dropping.
		ENG-38	The characteristics of engine-to-vehicle interfaces coupled with the capabilities of electronic engine controls, should negate the necessity for making any type of engine rigging including maximum power, idle, and idle cut-off.
		ENG-39	Engine-to-vehicle plumbing quick disconnects should contain positive visual indication that the interface is fully seated and locked.
		ENG-40	Design of electronic engine controls should be such that no single failure of a sub-component within can result in over speed, over temperature, stagnation, or shut-down.
		ENG-41	Use captive fasteners containing self-locking features to attach the nose dome to the engine face. The fasteners should be fully viewable during engine face FOD inspections.
		ENG-42	Attach engine-to-inlet duct interface seals to the vehicle so they can be left in place during engine removal.
		ENG-43	Design engine-to-inlet duct seal so the interface is automatic during engine installation without needing any form of alignment, adjustment, or mechanical attachment interface.
		ENG-44	Select engine-to-inlet duct seal material to ensure seal life is sufficient for the life of the vehicle.

Guidelines by Category (Cont'd)

Category No.	Category Title	Guideline No.	Guideline
3.02.02	Engines (Turbine-driven)	ENG-45	Provide remote servicing points accessible from the ground to service engine accessories mounted on top of the engine (e.g., oil tanks, gear boxes, generators, etc.) to eliminate climbing upon or atop the host vehicle.
		ENG-46	Design the basic engine and engine-mounted accessory interface so that no fluid traps or bathtubs exist regardless of engine-mounted accessory location.
		ENG-47	Design the engine, including all accessories, plumbing, wiring, ducts, and mechanisms, to meet the same environmental protection and compatibility requirements as the host vehicle.
		ENG-48	Do not drain or dump residual fuel in the engine fuel control/manifold overboard. When it is not possible to follow this guideline, route the fuel to an engine-mounted collector tank capable of retaining fuel from two shutdowns.
		ENG-49	Design engine fuel and oil filters with integral locking features so they can be installed and removed by hand, and require no torquing.
		ENG-50	Design engine fuel and oil filter delta pressure indicators so they can be reset only from within the filter housing.
		ENG-51	Provide engine fuel and oil filters with anti-surge protection to ensure false delta pressure indications do not occur.
		ENG-52	Incorporate provisions to enable very slow rotation of the fan, compressor, and turbine during borescope inspections.
		ENG-53	Design magnetic chip detectors to ensure that oil shut-off will occur as the detector is being removed for visual inspection.
		ENG-54	Incorporate provisions for fuzz burn-off in magnetic chip detectors.
		ENV-05	For airborne vehicles, materials and all finishes with the engine inlet should be durable against hammer shock and compressor stalls.
		ENV-06	For ground vehicles, the finishes should be compatible with and durable against all rain, hail, sleet, snow, and ice conditions experienced in all intended operational environments.
		EXH-01	Treatments required for engine hot sections and exhaust areas should not require scheduled removals for the purposes of recoating.
		EXH-02	High temperature exhaust patterns should flow away from or be directed away from treated surrounding structure, coatings, or finishes.
		EXTING-01	Use extinguishing concepts dedicated to each individual fire zone in preference to manifold systems operating from a central source.
		EXTING-02	Design sealed extinguishing agent containers with an integral pressure/volume gage and a pressure-sensing transmitter for remote read-out.
		EXTING-03	Keep each individual fire zone over-temperature/fire warning system separate from those in other fire zones.
		EXTING-04	Design individual fire zone over-temperature/fire warning system to be fully BIT capable (the BIT concept should permit both initiated and periodic BIT).
		EXTING-05	Route and locate all tube, wire, and plumbing interfaces in a manner that prevents induced damage during maintenance.
		GBD-01	Guidelines for transmissions, clutches, and rotors apply.
		GBD-02	Use the host gear box lubricating system to provide lubrication of the drive shaft spline.
		GBD-03	Design drive shafts using the "blind spline" concept to ensure correct mating of the shaft to the gear box.
		GBD-04	Design drive shafts with a simple, light-weight cover to protect personnel.
		GBD-05	Design drive shaft covers with a hole or slot type opening to prevent the masking of leakage or damage.
		HF-03	Provide hoist fittings or hardpoints for hoist fitting attachments that are readily accessible.
		HOOK-06	Avoid the need to remove the tail hook to facilitate engine access or removal.
		IN(V)-01	Design inlet door actuators and door actuation mechanisms so they not protrude into the air inlet flow field to eliminate FOD potential.
		IN(V)-02	Do not use loose structural fasteners in the access area to inlet door actuators and mechanisms. Where this guideline cannot be followed, design the actuator door to be accessible only when the inlet doors are fully closed.
		IN(V)-03	For engine inlet bellmouth fairings, use methods of retention other than fasteners. Latches may be considered as an acceptable alternative only if latch-to-panel retention is from the inner mold line.

Guidelines by Category (Cont'd)

Category No.	Category Title	Guideline No.	Guideline
3.02.02	Engines (Turbine-driven)	IN(V)-04	Design inlet doors and inlet bellmouth fairings to be fully interchangeable to eliminate the need to cut, file, or trim at the engine face.
		IN(V)-05	Locate the inlet duct edge a minimum of 60 inches from the cockpit or crew station to eliminate restricting engine operation to canopy-closed conditions.
		IN(V)-06	Use captive fasteners on all access doors forward of the inlet to significantly reduce engine FOD potential.
		IN(V)-07	Ensure that no ground safety pins or streamers are used forward of the inlet or within a 3-foot radius aft of the inlet.
		IN(V)-08	Incorporate an inlet closure door sealing concept that prevents entry of fluid, dust, or sand across the entire airborne and ground environment spectrum.
		IN-01	Low Observable (L.O) engine face frames should be within 10 inches of the first stage fan or compressor blades.
		IN-02	Openings throughout the engine face frame should be sufficient to perform a 100% FOD inspection of the engine face.
		IN-03	Openings throughout the engine face frame should be sufficient to permit minor blending or repair of FOD without removing the engine.
		IN-04	For frames not integral with the engine, frame removal should be achievable from the engine cavity.
		IN-05	Both integral and remote engine front frames should be interchangeable.
		IN-06	Front frame anti-ice and de-ice provisions should give preference to engine hot bleed air.
		LG-04	Do not use Beryllium and Beryllium base alloys in any location subject to wear or corrosive atmospheres or in installations where machining may be required.
		LG-05	All bolts or similar threaded means used as adjustable stops should be positively retained in the adjusted reference without reliance on jam nuts, cotter pins, or safety wire.
		MC-01	All clamps should contain torque-set or torque-limiting connections to prevent clamp or component failure due to over-torque. Clamp installation call outs should not depend on special tools to establish the required torque values.
		MC-02	Avoid the use of cotter pins, safety wire, safety clips, and similar devices to prevent maintenance-induced events leading to ground vehicle accidents or loss of air vehicles.
		MC-03	All tubing connections and interfaces should use rosan/dynatube (or equivalent) to (1) enable connect or disconnect with one hand, one tool, (2) eliminate the need to safety the connection, (3) provide a superior seal, and (4) negate need to reposition line(s) during component replacement.
		MC-04	No trombone type, flared tube type, or piloted line type interfaces should be used to avoid the need for removal or repositioning during equipment removal.
		MC-05	Avoid potential foreign object traps during manufacturing or operational maintenance by eliminating vertical penetrations of plumbing/fittings into tanks, compartments, or cells
		MC-06	Locate, position, orient all plumbing and duct electrical connectors to prevent the need for sequential installation or removal.
		MC-09	All plumbing connections and fittings used for fuel systems should contain integral bonding features to eliminate the need for bonding clamps or jumper cables.
		MC-10	In rare instances where a plumbing run contains complex form or geometry that would require removal of other plumbing or equipment for access, in-line connectors should be incorporated to maintain the integrity of other plumbing or equipment.
		MC-11	No subsystem plumbing, equipment, or wiring should use a tank, cell, or compartment containing liquids as a means for routing or penetration simplicity during manufacture.
		MC-12	All plumbing and connectors containing liquids should be meniscus-free.
		MC-13	In instances where plumbing or connector interfaces cannot or are not keyed for a specific orientation, all identification, markings, cautions, and directions should be placed 360 degrees around the tube or duct.
		MC-14	Where multiple connectors are located in close proximity, ensure (1) a minimum hand tool arc of 120 degrees can be maintained, and (2) stagger fittings to ensure firm coupling interface/hand tool interface can be accomplished without inducing damage to adjacent lines.
		MP-01	Avoid the use epoxies to mount parts on repairable modules because they make repair extremely difficult.

Guidelines by Category (Cont'd)

Category No.	Category Title	Guideline No.	Guideline
3.02.02	Engines (Turbine-driven)	MP-02	Use a unique identification (ID) resistor incorporated in each system module to verify that the proper module is mounted on ATE.
		MP-03	Design modules so that lengthy warm-up times, special coding and air purity levels, and similar constraints are not necessary.
		TCR-01	For each transmission, clutch, or rotor, provide a dedicated lubricating oil supply tank and system that is not shared with any other oil lubricating system.
		TCR-02	Provide each dedicated oil supply system with a separate servicing port/interface, pressure gauging, and quantity gauging system as applicable.
		TCR-03	Use a singular gage capable of reading pressures or quantities from two or more lubricating systems in preference to individual gages.
		TCR-04	Provide each dedicated system with an on-board spectrometric oil analysis program capability, separate oil filter, and separate oil, fuel, or air heat exchanger capability.
		TCR-05	Use the item's self-contained oil system to provide drive/interface spline lubrication, if required.
		TCR-06	In complex units, use different tracer elements in multiple gears, plates, discs, etc., so the source of wear can be easily identified by spectrometric oil analysis monitoring units.
		TCR-07	Design mechanical interfaces to transmissions, clutches, and rotors so that the respective unit can be replaced without the need for rigging.
		TCR-08	Incorporate vibration pick-up sensors to isolate the respective unit from other potential sources of vibration, and to enhance the prognostic potential for monitoring equipment health.
		A-04	Use stiffening beads in lieu of flanges to the maximum extent to enhance compartment volume and simplify repairs. Stiffening beads should have the convex surface toward the compartment to eliminate fluid traps.
		A-05	Keep all machined compartment frames, webs, and closure panels to a constant thickness (e.g., not stepped or tapered) to ease simplicity of fluid or electrical penetrations and ease and simplicity of structural repair.
		A-06	Hardpoints (structural attachment and load bearing areas) within a compartment to assist in equipment mounting or support should not be integral with the machined part. Hardpoints should be parasitic to enable quick repair in case of wear or damage in lieu of precise ream/bush repair typical of machined hardpoints.
A-08	Plumbing penetrations into a compartment should not be on a vertical axis due to difficulty in making or breaking vertically-oriented connections. When compartment access is from the bottom, vertically-oriented connections can allow fluid to leak onto the maintainer. When access is from the top, such connections can allow foreign matter to enter the line. Use horizontal penetrations whenever possible.		
A-09	Any heat or temperature sensitive structure within a compartment should contain heat-sensitive tape or appropriate heat sensor for easy indication of over-temperature excursions.		
A-13	Two-sided or two-surfaced access should not be required for access to equipment interfaces and hardpoints. The term two-sided infers top/bottom, left/right, front/back, or combinations thereof.		
A-18	Use transparent windows, quick-opening covers, or openings without any cover to permit quick visual inspections where needed.		
BIT-01	During design of the BIT, use worst-case stress analysis to ensure that any circuit failures induced by temperature extremes, tolerance build-up, power supply variations, and combinations thereof are identified.		
BIT-02	Ensure that BIT system thresholds are consistent with those across the system, subsystem, item, module, and piece-part levels to prevent excessive numbers of Cannot Duplicate (CND) and Retest OK (RTOK) events from occurring.		
BIT-03	The degree of BIT required or proposed should be based on the respective failure rates and the appropriate FMECA at all equipment indeture levels.		
BIT-04	Limit the amount of data that is recorded to a manageable size by: <ul style="list-style-type: none"> - Limiting the number of signals that are monitored - Limiting the maximum sampling rate - Reducing the time span over which data is accumulated - Restricting the type of data accumulated 		

Guidelines by Category (Cont'd)

Category No.	Category Title	Guideline No.	Guideline
3.02.03	Transmissions, Clutches, and Rotors	BIT-05	Incorporate testability design features as an integral part of equipment preliminary design process.
		BIT-06	Mission critical functions should be monitored by BIT.
		BIT-09	Use concurrent BIT to monitor system critical functions.
		BIT-20	The BIT should be mechanized so that when a piece of equipment is not installed in a subsystem or the product, a failure will not be indicated.
		BIT-26	Locate routinely used test points so they are accessible without removing or disassembling other equipment
		C-01	Avoid swivel type connectors and fittings for air, fuel, or hydraulic line interfaces due to their history of low reliability.
		C-02	Provide spacing between parallel plumbing runs so that in-line couplings can be replaced without removing lines or disconnecting any line support devices.
		CBR-01	Orient all vehicle liquid servicing fittings to ensure fluids will not come in contact with protective garb during connect/disconnect activities.
		CBR-02	Ensure vehicle overboard passive liquid drains are clearly marked or visible to enable personnel to remain clear of area.
		CONT-01	Control rods should use Boyd or impedance type bolts (or equivalent) to eliminate the need for cotter pins or safety wire.
		CONT-02	Do not use metal control cables for vehicles that will operate in salt water or salt air environments.
		CONT-03	Use control rods rather than control cables for non-complex applications and non-complex routing within the vehicle.
		CONT-04	Use control cables rather than control rods for most complex applications.
		CONT-05	Route cables so that 100 percent of a cable will be viewable for inspection.
		CONT-06	Design all pulleys and brackets associated with cable installations so they are accessible by a 75 percentile male hand.
		ENG-01	All facets of engine design should take advantage of Electrostatic Engine Monitoring Systems (EEMS) and Inductive Debris Monitoring (IDM) toward achievement of on-condition maintenance and engine health monitoring.
		ENG-02	Each different component of rotating machinery should contain different tracer elements to enhance EEMS and IDM isolation and tracking of wear.
		ENG-03	Digital electronic controls, fully automatic digital electronic controls, and similar concepts should contain the highest degree of BIT and diagnostics commensurate with affordability, operation and maintenance, and life cycle costs as appropriate.
		ENG-04	The engine and engine-mounted gear box should have individual oil supplies to ensure wear or failures in one will not contaminate or fail the other.
		ENG-05	All engine-mounted air and fluid lines should be located next to the fan case, engine case, or full-length fan duct to ensure quick and simple replacement of accessories and components.
		ENG-06	All other engine surfaces and engine-mounted accessory surfaces should be free of pockets, channels, and bathtubs that could trap and retain fluids.
		ENG-07	Plumbing and wiring spanning two or more engine modules should contain in-line disconnects to enhance and simplify engine modularization.
		ENG-08	Use V-band clamps to mount accessories to engine-mounted gear boxes.
		ENG-09	On multi-engine air vehicles, the engines should be capable of being installed in any engine cavity without need for reconfiguration.
		ENG-10	On multi-engine air vehicles, the airframe-to-engine interfaces should be in identical positions or orientations for each engine cavity.
		ENG-12	All engine-mounted accessories must be capable of being removed and installed through the available airframe access openings.
		ENG-13	Engine oil systems should contain on-board spectrometric oil analysis devices located on the engine.
		ENG-14	Coring of engine gear box cases and housings to provide for fuel heat sink routing should take precedence over dedicated fuel or oil heat exchangers.
		ENG-20	Do not locate equipment or components in the engine cavity except for those components associated with the engine or engine installation.
		ENG-31	No rigging or calibration should be required subsequent to replacement of any engine-mounted component.

Guidelines by Category (Cont'd)

Category No.	Category Title	Guideline No.	Guideline
3.02.03	Transmissions, Clutches, and Rotors		
		ENG-34	Identification plates on the engine and all engine-mounted components should be viewable with the engine installed and engine access doors opened.
		ENG-35	No time-change components or scheduled actions should be planned solely to protect component integrity or reliability.
		ENG-36	All borecope mechanisms should have positive integral locking features.
		ENG-37	Gravity type servicing fittings, covers, and caps should have integral locking features, openable by hand, and contain a cable or chain to prevent loss or dropping.
		ENG-46	Design the basic engine and engine-mounted accessory interface so that no fluid traps or bathtubs exist regardless of engine-mounted accessory location.
		ENG-49	Design engine fuel and oil filters with integral locking features so they can be installed and removed by hand, and require no torquing.
		ENG-50	Design engine fuel and oil filter delta pressure indicators so they can be reset only from within the filter housing.
		ENG-53	Design magnetic chip detectors to ensure that oil shut-off will occur as the detector is being removed for visual inspection.
		ENG-54	Incorporate provisions for fuzz burn-off, in magnetic chip detectors.
		ENV-05	For airborne vehicles, materials and all finishes with the engine inlet should be durable against hammer shock and compressor stalls.
		ENV-06	For ground vehicles, the finishes should be compatible with and durable against all rain, hail, sleet, snow, and ice conditions experienced in all intended operational environments.
		EXTING-01	Use extinguishing concepts dedicated to each individual fire zone in preference to manifold systems operating from a central source.
		EXTING-02	Design sealed extinguishing agent containers with an integral pressure/volume gage and a pressure-sensing transmitter for remote read-out.
		EXTING-03	Keep each individual fire zone over-temperature/fire warning system separate from those in other fire zones.
		EXTING-04	Design individual fire zone over-temperature/fire warning system to be fully BIT capable (the BIT concept should permit both initiated and periodic BIT).
		EXTING-05	Route and locate all tube, wire, and plumbing interfaces in a manner that prevents induced damage during maintenance.
		GBD-01	Guidelines for transmissions, clutches, and rotors apply.
		GBD-02	Use the host gear box lubricating system to provide lubrication of the drive shaft spline.
		GBD-03	Design drive shafts using the "blind spline" concept to ensure correct mating of the shaft to the gear box.
		GBD-04	Design drive shafts with a simple, light-weight cover to protect personnel.
		GBD-05	Design drive shaft covers with a hole or slot type opening to prevent the masking of leakage or damage.
		LG-04	Do not use Beryllium and Beryllium base alloys in any location subject to wear or corrosive atmospheres or in installations where machining may be required.
		LG-05	All bolts or similar threaded means used as adjustable stops should be positively retained in the adjusted reference without reliance on jam nuts, cotter pins, or safety wire.
		MC-01	All clamps should contain torque-set or torque-limiting connections to prevent clamp or component failure due to over-torque. Clamp installation call outs should not depend on special tools to establish the required torque values.
		MC-02	Avoid the use of cotter pins, safety wire, safety clips, and similar devices to prevent maintenance-induced events leading to ground vehicle accidents or loss of air vehicles.
		MC-03	All tubing connections and interfaces should use rosan/dynatube (or equivalent) to (1) enable connect or disconnect with one hand, one tool, (2) eliminate the need to safety the connection, (3) provide a superior seal, and (4) negate need to reposition line(s) during component replacement.
		MC-04	No trombone type, flared tube type, or piloted line type interfaces should be used to avoid the need for removal or repositioning during equipment removal.
		MC-05	Avoid potential foreign object traps during manufacturing or operational maintenance by eliminating vertical penetrations of plumbing/fittings into tanks, compartments, or cells

Guidelines by Category (Cont'd)

Category No.	Category Title	Guideline No.	Guideline
3.02.03	Transmissions, Clutches, and Rotors	MC-06	Locate, position, orient all plumbing and duct electrical connectors to prevent the need for sequential installation or removal.
		MC-09	All plumbing connections and fittings used for fuel systems should contain integral bonding features to eliminate the need for bonding clamps or jumper cables.
		MC-10	In rare instances where a plumbing run contains complex form or geometry that would require removal of other plumbing or equipment for access, in-line connectors should be incorporated to maintain the integrity of other plumbing or equipment.
		MC-11	No subsystem plumbing, equipment, or wiring should use a tank, cell, or compartment containing liquids as a means for routing or penetration simplicity during manufacture.
		MC-12	All plumbing and connectors containing liquids should be meniscus-free.
		MC-13	In instances where plumbing or connector interfaces cannot or are not keyed for a specific orientation, all identification, markings, cautions, and directions should be placed 360 degrees around the tube or duct.
		MC-14	Where multiple connectors are located in close proximity, ensure (1) a minimum hand tool arc of 120 degrees can be maintained, and (2) stagger fittings to ensure firm coupling interface/hand tool interface can be accomplished without inducing damage to adjacent lines.
		MP-01	Avoid the use of epoxies to mount parts on repairable modules because they make repair extremely difficult.
		MP-02	Use a unique identification (ID) resistor incorporated in each system module to verify that the proper module is mounted on ATE.
		MP-03	Design modules so that lengthy warm-up times, special coding and air purity levels, and similar constraints are not necessary.
		TCR-01	For each transmission, clutch, or rotor, provide a dedicated lubricating oil supply tank and system that is not shared with any other oil lubricating system.
		TCR-02	Provide each dedicated oil supply system with a separate servicing port/interface, pressure gauging, and quantity gauging system as applicable.
		TCR-03	Use a singular gage capable of reading pressures or quantities from two or more lubricating systems in preference to individual gages.
		TCR-04	Provide each dedicated system with an on-board spectrometric oil analysis program capability, separate oil filter, and separate oil, fuel, or air heat exchanger capability.
		TCR-05	Use the item's self-contained oil system to provide drive/interface spline lubrication, if required.
		TCR-06	In complex units, use different tracer elements in multiple gears, plates, discs, etc., so the source of wear can be easily identified by spectrometric oil analysis monitoring units.
		TCR-07	Design mechanical interfaces to transmissions, clutches, and rotors so that the respective unit can be replaced without the need for rigging.
		TCR-08	Incorporate vibration pick-up sensors to isolate the respective unit from other potential sources of vibration, and to enhance the prognostic potential for monitoring equipment health.
3.02.04	Auxiliary, Secondary, and Emergency Power	A-04	Use stiffening beads in lieu of flanges to the maximum extent to enhance compartment volume and simplify repairs. Stiffening beads should have the convex surface toward the compartment to eliminate fluid traps.
		A-05	Keep all machined compartment frames, webs, and closure panels to a constant thickness (e.g., not stepped or tapered) to ease simplicity of fluid or electrical penetrations and ease and simplicity of structural repair.
		A-06	Hardpoints (structural attachment and load bearing areas) within a compartment to assist in equipment mounting or support should not be integral with the machined part. Hardpoints should be parasitic to enable quick repair in case of wear or damage in lieu of precise ream/bush repair typical of machined hardpoints.
		A-08	Plumbing penetrations into a compartment should not be on a vertical axis due to difficulty in making or breaking vertically-oriented connections. When compartment access is from the bottom, vertically-oriented connections can allow fluid to leak onto the maintainer. When access is from the top, such connections can allow foreign matter to enter the line. Use horizontal penetrations whenever possible.

Guidelines by Category (Cont'd)

Category No.	Category Title	Guideline No.	Guideline
3.02.04	Auxiliary, Secondary, and Emergency Power	A-09	Any heat or temperature sensitive structure within a compartment should contain heat-sensitive tape or appropriate heat sensor for easy indication of over-temperature excursions.
		A-13	Two-sided or two-surfaced access should not be required for access to equipment interfaces and hardpoints. The term two-sided infers top/bottom, left/right, front/back, or combinations thereof.
		A-18	Use transparent windows, quick-opening covers, or openings without any cover to permit quick visual inspections where needed.
		BIT-01	During design of the BIT, use worst-case stress analysis to ensure that any circuit failures induced by temperature extremes, tolerance build-up, power supply variations, and combinations thereof are identified.
		BIT-02	Ensure that BIT system thresholds are consistent with those across the system, subsystem, item, module, and piece-part levels to prevent excessive numbers of Cannot Duplicate (CND) and Retest OK (RTOK) events from occurring.
		BIT-03	The degree of BIT required or proposed should be based on the respective failure rates and the appropriate FMECA at all equipment indenture levels.
		BIT-04	Limit the amount of data that is recorded to a manageable size by: <ul style="list-style-type: none"> - Limiting the number of signals that are monitored - Limiting the maximum sampling rate - Reducing the time span over which data is accumulated - Restricting the type of data accumulated
		BIT-05	Incorporate testability design features as an integral part of equipment preliminary design process.
		BIT-06	Mission critical functions should be monitored by BIT.
		BIT-09	Use concurrent BIT to monitor system critical functions.
		BIT-20	The BIT should be mechanized so that when a piece of equipment is not installed in a subsystem or the product, a failure will not be indicated.
		BIT-26	Locate routinely used test points so they are accessible without removing or disassembling other equipment
		C-01	Avoid swivel type connectors and fittings for air, fuel, or hydraulic line interfaces due to their history of low reliability.
		C-02	Provide spacing between parallel plumbing runs so that in-line couplings can be replaced without removing lines or disconnecting any line support devices.
		CBR-01	Orient all vehicle liquid servicing fittings to ensure fluids will not come in contact with protective garb during connect/disconnect activities.
		CBR-02	Ensure vehicle overboard passive liquid drains are clearly marked or visible to enable personnel to remain clear of area.
		CONT-01	Control rods should use Boyd or impedance type bolts (or equivalent) to eliminate the need for cotter pins or safety wire.
		CONT-02	Do not use metal control cables for vehicles that will operate in salt water or salt air environments.
		CONT-03	Use control rods rather than control cables for non-complex applications and non-complex routing within the vehicle.
		CONT-04	Use control cables rather than control rods for most complex applications.
		CONT-05	Route cables so that 100 percent of a cable will be viewable for inspection.
		CONT-06	Design all pulleys and brackets associated with cable installations so they are accessible by a 75 percentile male hand.
		ENG-01	All facets of engine design should take advantage of Electrostatic Engine Monitoring Systems (EEMS) and Inductive Debris Monitoring (IDM) toward achievement of on-condition maintenance and engine health monitoring.
		ENG-02	Each different component of rotating machinery should contain different tracer elements to enhance EEMS and IDM isolation and tracking of wear.
		ENG-03	Digital electronic controls, fully automatic digital electronic controls, and similar concepts should contain the highest degree of BIT and diagnostics commensurate with affordability, operation and maintenance, and life cycle costs as appropriate.
		ENG-04	The engine and engine-mounted gear box should have individual oil supplies to ensure wear or failures in one will not contaminate or fail the other.
		ENG-05	All engine-mounted air and fluid lines should be located next to the fan case, engine case, or full-length fan duct to ensure quick and simple replacement of accessories and components.

MIL-HDBK-470A

APPENDIX C

Guidelines by Category (Cont'd)

Category No.	Category Title	Guideline No.	Guideline
3.02.04	Auxiliary, Secondary, and Emergency Power	ENG-06	All other engine surfaces and engine-mounted accessory surfaces should be free of pockets, channels, and bathtubs that could trap and retain fluids.
		ENG-07	Plumbing and wiring spanning two or more engine modules should contain in-line disconnects to enhance and simplify engine modularization.
		ENG-08	Use V-band clamps to mount accessories to engine-mounted gear boxes.
		ENG-09	On multi-engine air vehicles, the engines should be capable of being installed in any engine cavity without need for reconfiguration.
		ENG-10	On multi-engine air vehicles, the airframe-to-engine interfaces should be in identical positions or orientations for each engine cavity.
		ENG-11	Control-by-wire or control-by-light throttling concepts should take precedence over mechanical controls.
		ENG-12	All engine-mounted accessories must be capable of being removed and installed through the available airframe access openings.
		ENG-13	Engine oil systems should contain on-board spectrometric oil analysis devices located on the engine.
		ENG-14	Coring of engine gear box cases and housings to provide for fuel heat sink routing should take precedence over dedicated fuel or oil heat exchangers.
		ENG-20	Do not locate equipment or components in the engine cavity except for those components associated with the engine or engine installation.
		ENG-34	Identification plates on the engine and all engine-mounted components should be viewable with the engine installed and engine access doors opened.
		ENG-35	No time-change components or scheduled actions should be planned solely to protect component integrity or reliability.
		ENG-36	All borescope mechanisms should have positive integral locking features.
		ENG-37	Gravity type servicing fittings, covers, and caps should have integral locking features, openable by hand, and contain a cable or chain to prevent loss or dropping.
		ENG-40	Design of electronic engine controls should be such that no single failure of a sub-component within can result in over speed, over temperature, stagnation, or shut-down.
		ENG-49	Design engine fuel and oil filters with integral locking features so they can be installed and removed by hand, and require no torquing.
		ENG-50	Design engine fuel and oil filter delta pressure indicators so they can be reset only from within the filter housing.
		ENG-53	Design magnetic chip detectors to ensure that oil shut-off will occur as the detector is being removed for visual inspection.
		ENG-54	Incorporate provisions for fuzz burn-off in magnetic chip detectors.
		ENV-05	For airborne vehicles, materials and all finishes with the engine inlet should be durable against hammer shock and compressor stalls.
		ENV-06	For ground vehicles, the finishes should be compatible with and durable against all rain, hail, sleet, snow, and ice conditions experienced in all intended operational environments.
		EXH-01	Treatments required for engine hot sections and exhaust areas should not require scheduled removals for the purposes of recoating.
		EXH-02	High temperature exhaust patterns should flow away from or be directed away from treated surrounding structure, coatings, or finishes.
		EXTING-01	Use extinguishing concepts dedicated to each individual fire zone in preference to manifold systems operating from a central source.
		EXTING-02	Design sealed extinguishing agent containers with an integral pressure/volume gage and a pressure-sensing transmitter for remote read-out.
		EXTING-03	Keep each individual fire zone over-temperature/fire warning system separate from those in other fire zones.
		EXTING-04	Design individual fire zone over-temperature/fire warning system to be fully BIT capable (the BIT concept should permit both initiated and periodic BIT).

Guidelines by Category (Cont'd)

Category No.	Category Title	Guideline No.	Guideline
3.02.04	Auxiliary, Secondary, and Emergency Power	EXTING-05	Route and locate all tube, wire, and plumbing interfaces in a manner that prevents induced damage during maintenance.
		GBD-01	Guidelines for transmissions, clutches, and rotors apply.
		GBD-02	Use the host gear box lubricating system to provide lubrication of the drive shaft spline.
		GBD-03	Design drive shafts using the "blind spline" concept to ensure correct mating of the shaft to the gear box.
		GBD-04	Design drive shafts with a simple, light-weight cover to protect personnel.
		GBD-05	Design drive shaft covers with a hole or slot type opening to prevent the masking of leakage or damage.
		HF-03	Provide hoist fittings or hardpoints for hoist fitting attachments that are readily accessible.
		LG-04	Do not use Beryllium and Beryllium base alloys in any location subject to wear or corrosive atmospheres or in installations where machining may be required.
		LG-05	All bolts or similar threaded means used as adjustable stops should be positively retained in the adjusted reference without reliance on jam nuts, cotter pins, or safety wire.
		MC-01	All clamps should contain torque-set or torque-limiting connections to prevent clamp or component failure due to over-torque. Clamp installation call outs should not depend on special tools to establish the required torque values.
		MC-02	Avoid the use of cotter pins, safety wire, safety clips, and similar devices to prevent maintenance-induced events leading to ground vehicle accidents or loss of air vehicles.
		MC-03	All tubing connections and interfaces should use rosan/dynatube (or equivalent) to (1) enable connect or disconnect with one hand, one tool, (2) eliminate the need to safety the connection, (3) provide a superior seal, and (4) negate need to reposition line(s) during component replacement.
		MC-04	No trombone type, flared tube type, or piloted line type interfaces should be used to avoid the need for removal or repositioning during equipment removal.
		MC-05	Avoid potential foreign object traps during manufacturing or operational maintenance by eliminating vertical penetrations of plumbing/fittings into tanks, compartments, or cells
		MC-06	Locate, position, orient all plumbing and duct electrical connectors to prevent the need for sequential installation or removal.
		MC-09	All plumbing connections and fittings used for fuel systems should contain integral bonding features to eliminate the need for bonding clamps or jumper cables.
		MC-10	In rare instances where a plumbing run contains complex form or geometry that would require removal of other plumbing or equipment for access, in-line connectors should be incorporated to maintain the integrity of other plumbing or equipment.
		MC-11	No subsystem plumbing, equipment, or wiring should use a tank, cell, or compartment containing liquids as a means for routing or penetration simplicity during manufacture.
		MC-12	All plumbing and connectors containing liquids should be meniscus-free.
		MC-13	In instances where plumbing or connector interfaces cannot or are not keyed for a specific orientation, all identification, markings, cautions, and directions should be placed 360 degrees around the tube or duct.
		MC-14	Where multiple connectors are located in close proximity, ensure (1) a minimum hand tool arc of 120 degrees can be maintained, and (2) stagger fittings to ensure firm coupling interface/hand tool interface can be accomplished without inducing damage to adjacent lines.
		MP-01	Avoid the use epoxies to mount parts on repairable modules because they make repair extremely difficult.
		MP-02	Use a unique identification (ID) resistor incorporated in each system module to verify that the proper module is mounted on ATE.
		MP-03	Design modules so that lengthy warm-up times, special coding and air purity levels, and similar constraints are not necessary.
		TCR-01	For each transmission, clutch, or rotor, provide a dedicated lubricating oil supply tank and system that is not shared with any other oil lubricating system.
		TCR-02	Provide each dedicated oil supply system with a separate servicing port/interface, pressure gauging, and quantity gauging system as applicable.

Guidelines by Category (Cont'd)

Category No.	Category Title	Guideline No.	Guideline
3.02.04	Auxiliary, Secondary, and Emergency Power	TCR-03	Use a singular gage capable of reading pressures or quantities from two or more lubricating systems in preference to individual gages.
		TCR-04	Provide each dedicated system with an on-board spectrometric oil analysis program capability, separate oil filter, and separate oil, fuel, or air heat exchanger capability.
		TCR-05	Use the item's self-contained oil system to provide drive/interface spline lubrication, if required.
		TCR-06	In complex units, use different tracer elements in multiple gears, plates, discs, etc., so the source of wear can be easily identified by spectrometric oil analysis monitoring units.
		TCR-07	Design mechanical interfaces to transmissions, clutches, and rotors so that the respective unit can be replaced without the need for rigging.
		TCR-08	Incorporate vibration pick-up sensors to isolate the respective unit from other potential sources of vibration, and to enhance the prognostic potential for monitoring equipment health.
3.02.05	Gear Boxes and Drives	A-04	Use stiffening beads in lieu of flanges to the maximum extent to enhance compartment volume and simplify repairs. Stiffening beads should have the convex surface toward the compartment to eliminate fluid traps.
		A-05	Keep all machined compartment frames, webs, and closure panels to a constant thickness (e.g., not stepped or tapered) to ease simplicity of fluid or electrical penetrations and ease and simplicity of structural repair.
		A-06	Hardpoints (structural attachment and load bearing areas) within a compartment to assist in equipment mounting or support should not be integral with the machined part. Hardpoints should be parasitic to enable quick repair in case of wear or damage in lieu of precise ream/bush repair typical of machined hardpoints.
		A-08	Plumbing penetrations into a compartment should not be on a vertical axis due to difficulty in making or breaking vertically-oriented connections. When compartment access is from the bottom, vertically-oriented connections can allow fluid to leak onto the maintainer. When access is from the top, such connections can allow foreign matter to enter the line. Use horizontal penetrations whenever possible.
		A-09	Any heat or temperature sensitive structure within a compartment should contain heat-sensitive tape or appropriate heat sensor for easy indication of over-temperature excursions.
		A-13	Two-sided or two-surfaced access should not be required for access to equipment interfaces and hardpoints. The term two-sided infers top/bottom, left/right, front/back, or combinations thereof.
		A-18	Use transparent windows, quick-opening covers, or openings without any cover to permit quick visual inspections where needed.
		BIT-01	During design of the BIT, use worst-case stress analysis to ensure that any circuit failures induced by temperature extremes, tolerance build-up, power supply variations, and combinations thereof are identified.
		BIT-02	Ensure that BIT system thresholds are consistent with those across the system, subsystem, item, module, and piece-part levels to prevent excessive numbers of Cannot Duplicate (CND) and Retest OK (RTOK) events from occurring.
		BIT-03	The degree of BIT required or proposed should be based on the respective failure rates and the appropriate FMECA at all equipment indeture levels.
		BIT-04	Limit the amount of data that is recorded to a manageable size by: <ul style="list-style-type: none"> - Limiting the number of signals that are monitored - Limiting the maximum sampling rate - Reducing the time span over which data is accumulated - Restricting the type of data accumulated
		BIT-05	Incorporate testability design features as an integral part of equipment preliminary design process.
		BIT-06	Mission critical functions should be monitored by BIT.
		BIT-09	Use concurrent BIT to monitor system critical functions.
		BIT-26	Locate routinely used test points so they are accessible without removing or disassembling other equipment
		C-01	Avoid swivel type connectors and fittings for air, fuel, or hydraulic line interfaces due to their history of low reliability.
		C-02	Provide spacing between parallel plumbing runs so that in-line couplings can be replaced without removing lines or disconnecting any line support devices.

Guidelines by Category (Cont'd)

Category No.	Category Title	Guideline No.	Guideline
3.02.05	Gear Boxes and Drives	CBR-01	Orient all vehicle liquid servicing fittings to ensure fluids will not come in contact with protective garb during connect/disconnect activities.
		CBR-02	Ensure vehicle overboard passive liquid drains are clearly marked or visible to enable personnel to remain clear of area.
		CONT-01	Control rods should use Boyd or impedance type bolts (or equivalent) to eliminate the need for cotter pins or safety wire.
		CONT-02	Do not use metal control cables for vehicles that will operate in salt water or salt air environments.
		CONT-03	Use control rods rather than control cables for non-complex applications and non-complex routing within the vehicle.
		CONT-04	Use control cables rather than control rods for most complex applications.
		CONT-05	Route cables so that 100 percent of a cable will be viewable for inspection.
		CONT-06	Design all pulleys and brackets associated with cable installations so they are accessible by a 75 percentile male hand.
		ENG-01	All facets of engine design should take advantage of Electrostatic Engine Monitoring Systems (EEMS) and Inductive Debris Monitoring (IDM) toward achievement of on-condition maintenance and engine health monitoring.
		ENG-02	Each different component of rotating machinery should contain different tracer elements to enhance EEMS and IDM isolation and tracking of wear.
		ENG-04	The engine and engine-mounted gear box should have individual oil supplies to ensure wear or failures in one will not contaminate or fail the other.
		ENG-05	All engine-mounted air and fluid lines should be located next to the fan case, engine case, or full-length fan duct to ensure quick and simple replacement of accessories and components.
		ENG-06	All other engine surfaces and engine-mounted accessory surfaces should be free of pockets, channels, and bathtubs that could trap and retain fluids.
		ENG-07	Plumbing and wiring spanning two or more engine modules should contain in-line disconnects to enhance and simplify engine modularization.
		ENG-08	Use V-band clamps to mount accessories to engine-mounted gear boxes.
		ENG-09	On multi-engine air vehicles, the engines should be capable of being installed in any engine cavity without need for reconfiguration.
		ENG-10	On multi-engine air vehicles, the airframe-to-engine interfaces should be in identical positions or orientations for each engine cavity.
		ENG-12	All engine-mounted accessories must be capable of being removed and installed through the available airframe access openings.
		ENG-13	Engine oil systems should contain on-board spectrometric oil analysis devices located on the engine.
		ENG-14	Coring of engine gear box cases and housings to provide for fuel heat sink routing should take precedence over dedicated fuel or oil heat exchangers.
		ENG-20	Do not locate equipment or components in the engine cavity except for those components associated with the engine or engine installation.
		ENG-21	Do not locate equipment or components in the engine bay cavity in a manner that would require removal or repositioning for engine removal.
		ENG-27	No rigging or calibration should be required following engine replacement.
		ENG-28	No engine operational start and checkout should be required following engine replacement.
		ENG-29	No functional check flight should be required following engine change. On twin engine aircraft where both engines were changed simultaneously, a functional test flight is permissible.
		ENG-31	No rigging or calibration should be required subsequent to replacement of any engine-mounted component.
		ENG-34	Identification plates on the engine and all engine-mounted components should be viewable with the engine installed and engine access doors opened.
		ENG-35	No time-change components or scheduled actions should be planned solely to protect component integrity or reliability.
		ENG-36	All borescope mechanisms should have positive integral locking features.
		ENG-37	Gravity type servicing fittings, covers, and caps should have integral locking features, openable by hand, and contain a cable or chain to prevent loss or dropping.

Guidelines by Category (Cont'd)

Category No.	Category Title	Guideline No.	Guideline
3.02.05	Gear Boxes and Drives	ENG-46	Design the basic engine and engine-mounted accessory interface so that no fluid traps or bathtubs exist regardless of engine-mounted accessory location.
		ENG-47	Design the engine, including all accessories, plumbing, wiring, ducts, and mechanisms, to meet the same environmental protection and compatibility requirements as the host vehicle.
		ENG-48	Do not drain or dump residual fuel in the engine fuel control/manifold overboard. When it is not possible to follow this guideline, route the fuel to an engine-mounted collector tank capable of retaining fuel from two shutdowns.
		ENG-49	Design engine fuel and oil filters with integral locking features so they can be installed and removed by hand, and require no torquing.
		ENG-50	Design engine fuel and oil filter delta pressure indicators so they can be reset only from within the filter housing.
		ENV-05	For airborne vehicles, materials and all finishes with the engine inlet should be durable against hammer shock and compressor stalls.
		ENV-06	For ground vehicles, the finishes should be compatible with and durable against all rain, hail, sleet, snow, and ice conditions experienced in all intended operational environments.
		EXTING-01	Use extinguishing concepts dedicated to each individual fire zone in preference to manifold systems operating from a central source.
		EXTING-02	Design sealed extinguishing agent containers with an integral pressure/volume gage and a pressure-sensing transmitter for remote read-out.
		EXTING-03	Keep each individual fire zone over-temperature/fire warning system separate from those in other fire zones.
		EXTING-04	Design individual fire zone over-temperature/fire warning system to be fully BIT capable (the BIT concept should permit both initiated and periodic BIT).
		EXTING-05	Route and locate all tube, wire, and plumbing interfaces in a manner that prevents induced damage during maintenance.
		GBD-01	Guidelines for transmissions, clutches, and rotors apply.
		GBD-02	Use the host gear box lubricating system to provide lubrication of the drive shaft spline.
		GBD-03	Design drive shafts using the "blind spline" concept to ensure correct mating of the shaft to the gear box.
		GBD-04	Design drive shafts with a simple, light-weight cover to protect personnel.
		GBD-05	Design drive shaft covers with a hole or slot type opening to prevent the masking of leakage or damage.
		HYD-06	Mount hydraulic pumps to the gear box flange with v-band clamps containing a torq-set or equivalent fastener.
		HYD-08	Design hydraulic pumps and motors with tracer elements to detect wear through on-board spectrometric oil analysis devices.
		LG-04	Do not use Beryllium and Beryllium base alloys in any location subject to wear or corrosive atmospheres or in installations where machining may be required.
		LG-05	All bolts or similar threaded means used as adjustable stops should be positively retained in the adjusted reference without reliance on jam nuts, cotter pins, or safety wire.
		MC-01	All clamps should contain torque-set or torque-limiting connections to prevent clamp or component failure due to over-torque. Clamp installation call outs should not depend on special tools to establish the required torque values.
		MC-02	Avoid the use of cotter pins, safety wire, safety clips, and similar devices to prevent maintenance-induced events leading to ground vehicle accidents or loss of air vehicles.
		MC-03	All tubing connections and interfaces should use rosan/dynatube (or equivalent) to (1) enable connect or disconnect with one hand, one tool, (2) eliminate the need to safety the connection, (3) provide a superior seal, and (4) negate need to reposition line(s) during component replacement.
		MC-04	No trombone type, flared tube type, or piloted line type interfaces should be used to avoid the need for removal or repositioning during equipment removal.
		MC-05	Avoid potential foreign object traps during manufacturing or operational maintenance by eliminating vertical penetrations of plumbing/fittings into tanks, compartments, or cells.
		MC-06	Locate, position, orient all plumbing and duct electrical connectors to prevent the need for sequential installation or removal.

Guidelines by Category (Cont'd)

Category No.	Category Title	Guideline No.	Guideline
3.02.05	Gear Boxes and Drives	MC-09	All plumbing connections and fittings used for fuel systems should contain integral bonding features to eliminate the need for bonding clamps or jumper cables.
		MC-10	In rare instances where a plumbing run contains complex form or geometry that would require removal of other plumbing or equipment for access, in-line connectors should be incorporated to maintain the integrity of other plumbing or equipment.
		MC-11	No subsystem plumbing, equipment, or wiring should use a tank, cell, or compartment containing liquids as a means for routing or penetration simplicity during manufacture.
		MC-12	All plumbing and connectors containing liquids should be meniscus-free.
		MC-13	In instances where plumbing or connector interfaces cannot or are not keyed for a specific orientation, all identification, markings, cautions, and directions should be placed 360 degrees around the tube or duct.
		MC-14	Where multiple connectors are located in close proximity, ensure (1) a minimum hand tool arc of 120 degrees can be maintained, and (2) stagger fittings to ensure firm coupling interface/hand tool interface can be accomplished without inducing damage to adjacent lines.
		MP-01	Avoid the use of epoxies to mount parts on repairable modules because they make repair extremely difficult.
		MP-02	Use a unique identification (ID) resistor incorporated in each system module to verify that the proper module is mounted on ATE.
		MP-03	Design modules so that lengthy warm-up times, special coding and air purity levels, and similar constraints are not necessary.
		SABCH-06	Structural design should avoid the potential of dissimilar material or fastener corrosion.
		SABCH-07	No structural fasteners should be used that require special tools for installation.
		SABCH-08	Taper pins should be threaded and retained with self-locking hardware.
		SABCH-09	Pins and collars (lockbolts) should only be used in applications which do not normally require removal.
		SABCH-10	Do not use lockbolts in composites.
		TCR-01	For each transmission, clutch, or rotor, provide a dedicated lubricating oil supply tank and system that is not shared with any other oil lubricating system.
		TCR-02	Provide each dedicated oil supply system with a separate servicing port/interface, pressure gauging, and quantity gauging system as applicable.
		TCR-03	Use a singular gage capable of reading pressures or quantities from two or more lubricating systems in preference to individual gages.
		TCR-04	Provide each dedicated system with an on-board spectrometric oil analysis program capability, separate oil filter, and separate oil, fuel, or air heat exchanger capability.
		TCR-05	Use the item's self-contained oil system to provide drive/interface spline lubrication, if required.
		TCR-06	In complex units, use different tracer elements in multiple gears, plates, discs, etc., so the source of wear can be easily identified by spectrometric oil analysis monitoring units.
		TCR-07	Design mechanical interfaces to transmissions, clutches, and rotors so that the respective unit can be replaced without the need for rigging.
		TCR-08	Incorporate vibration pick-up sensors to isolate the respective unit from other potential sources of vibration, and to enhance the prognostic potential for monitoring equipment health.
3.02.06	Exhaust Exits, Nozzles, and Outlets	A-13	Two-sided or two-surfaced access should not be required for access to equipment interfaces and hardpoints. The term two-sided infers top/bottom, left/right, front/back, or combinations thereof.
		BIT-06	Mission critical functions should be monitored by BIT.
		BIT-09	Use concurrent BIT to monitor system critical functions.
		D&V-01	The geometric aspects of structural design and interfaces should not result in any natural bathtubs.
		D&V-02	Closed structural sections subject to condensation or fluid migration should contain drainage provisions.

Guidelines by Category (Cont'd)

Category No.	Category Title	Guideline No.	Guideline
3.02.06	Exhaust Exits, Nozzles, and Outlets	D&V-03	Crew cabs, operators' compartments, crew stations, cockpits, and passenger compartments should be subject to the same corrosion prevention measures as the exteriors of the vehicles. Low points, pockets, and related fluid collection points within should be provided with low point drains.
		ECS-11	Design air inlets, outlets, and exhausts to be accessible without reliance on ladders or work stands for ease of installing protective plugs or covers.
		ECS-12	Design air inlets, outlets, and exhausts with screens to prevent bird or rodent entry.
		ECS-13	Design air inlets, outlets, and exhausts to be meniscus-free to prevent a bathub effect. In remote instances where this is not possible, passive drains should be provided at all low points to prevent liquid accumulation with the vehicle in its normal static attitude.
		ECS-14	Instances where air inlets, outlets, and exhausts are subject to water entry, passive drains should be employed capable of handling 4" of rain per hour.
		ECS-15	Locate and orient air inlets, outlets, and exhausts in a manner that prevents their use as footholds during maintenance.
		EDECOM-01	Provide surface sensors on equipment located in compartments containing louvers, screens, flush inlets, or similar openings to the environment to indicate the presence of chem/bio contaminants.
		EDECOM-02	Provide integral sensors (viewable from the exterior) for equipment subject to internal forced-air cooling from outside or external air to indicate the presence of contaminants.
		EDECOM-03	Design equipment surfaces and structure to be compatible with all decontamination agents and methods.
		EDECOM-04	Provide passive overboard drains in compartments subject to decontamination processes to void the area of contaminants.
		EDECOM-05	Provide hoist, lift or transport handles for equipment requiring removal from the host vehicle for decontamination. In instances where this may not be practical, design the equipment with hardpoints for attaching parasitic carrying provisions
		ENG-01	All facets of engine design should take advantage of Electrostatic Engine Monitoring Systems (EEMS) and Inductive Debris Monitoring (IDM) toward achievement of on-condition maintenance and engine health monitoring.
		ENG-02	Each different component of rotating machinery should contain different tracer elements to enhance EEMS and IDM isolation and tracking of wear.
		ENG-12	All engine-mounted accessories must be capable of being removed and installed through the available airframe access openings.
		ENG-22	The engine cavity structure should be capable of withstanding a 2000-degree Fahrenheit fire for 10 minutes without jeopardizing loss of the vehicle.
		ENG-23	All engine borescope provisions should be accessible with the engine installed and hooked up.
		ENG-27	No rigging or calibration should be required following engine replacement.
		ENG-28	No engine operational start and checkout should be required following engine replacement.
		ENG-29	No functional check flight should be required following engine change. On twin engine aircraft where both engines were changed simultaneously, a functional test flight is permissible.
		ENG-31	No rigging or calibration should be required subsequent to replacement of any engine-mounted component.
		ENG-34	Identification plates on the engine and all engine-mounted components should be viewable with the engine installed and engine access doors opened.
		ENG-35	No time-change components or scheduled actions should be planned solely to protect component integrity or reliability.
		ENG-36	All borescope mechanisms should have positive integral locking features.
		ENG-47	Design the engine, including all accessories, plumbing, wiring, ducts, and mechanisms, to meet the same environmental protection and compatibility requirements as the host vehicle.
		ENV-01	Materials, treatments, coatings, finishes should be compatible with all anti-ice and de-ice fluids, chemical and biological decontamination fluids, washing and cleaning fluids, and all vehicle subsystem fluids.
		ENV-02	There should be no top coat or treatment deterioration throughout the standard temperature and humidity spectrum.
		ENV-03	For airborne vehicles, the finishes should be durable against rain, hail, and dynamic erosion throughout the flight envelope.

Guidelines by Category (Cont'd)

Category No.	Category Title	Guideline No.	Guideline
3.02.06	Exhaust Exits, Nozzles, and Outlets	ENV-04	For airborne and ground vehicles, the finishes should be durable against sand erosion throughout all surface wind speeds experienced in arid or desert geographical locations.
		ENV-06	For ground vehicles, the finishes should be compatible with and durable against all rain, hail, sleet, snow, and ice conditions experienced in all intended operational environments.
		EXH-01	Treatments required for engine hot sections and exhaust areas should not require scheduled removals for the purposes of recoating.
		EXH-02	High temperature exhaust patterns should flow away from or be directed away from treated surrounding structure, coatings, or finishes.
		EXTING-01	Use extinguishing concepts dedicated to each individual fire zone in preference to manifold systems operating from a central source.
		EXTING-02	Design sealed extinguishing agent containers with an integral pressure/volume gage and a pressure-sensing transmitter for remote read-out.
		EXTING-03	Keep each individual fire zone over-temperature/fire warning system separate from those in other fire zones.
		EXTING-04	Design individual fire zone over-temperature/fire warning system to be fully BIT capable (the BIT concept should permit both initiated and periodic BIT).
		EXTING-05	Route and locate all tube, wire, and plumbing interfaces in a manner that prevents induced damage during maintenance.
		F-01	Use blind fasteners only where absolutely necessary or where considerable cost can be saved.
		F-02	Minimize access fasteners while making them quick release, easily removed and replaced, and captive.
		F-03	Choose fasteners based on the requirement to operate by hand or with common hand tools rather than special tools.
		F-04	Whenever possible, incorporate barrel type fasteners as opposed to hi-torque fasteners. Failure of Hi-torque fasteners due to stripping are common and a source of potential foreign object damage (FOD).
		HOOK-06	Avoid the need to remove the tail hook to facilitate engine access or removal.
		HOOK-07	Incorporate remote means to read the tail hook dampener pressure charge to enhance carrier suitability.
		LO-05	Do not locate flush mounted LO screens for auxiliary air inlets and exits in walkway areas unless durability has been proven.
		LO-06	Size flush mounted LO screens for auxiliary air inlets and exits to ensure functionality with up to 25 percent of the openings plugged.
		LO-07	Flush and non-flush LO screens should be interchangeable.
		MATL-02	Cosmetic type repairs should not exceed 1 hour including cure or drying times.
		MATL-03	Cosmetic and vehicle repair material shelf life should not be less than 24 months.
		MATL-04	Cosmetic and vehicle repair materials should be non-proprietary and non-single source.
		MATL-05	Cosmetic and vehicle repair materials should not require refrigeration or special facilities or atmospheres for storage.
		MATL-06	Repair criteria, repairs, and instructions should not be classified.
		MATL-07	All cosmetic touch-up and repair materials should be environmentally safe.
		MATL-08	Repairs (other than major depot repair) should not require autoclave type facilities.
		MATL-09	A high degree of durability should be achieved across all walkway areas on the top surfaces of all vehicles up to and including 95 percentile personnel.
		MATL-10	Coatings and finishes should be durable against the effects of missile gases, velocities, and particles emanating from the missile motor.
		MATL-11	Coatings and finishes should be durable against the effects of gun gases, projectile shock waves, and brass particles emanating from the projectile seal rings.
		MATL-13	Special handling or shipping requirements of repair materials should be avoided.
		MATL-15	Doors and panels containing blade seals used for signature reduction should be interchangeable or contain interchangeable blade seals. Deviation is acceptable where repairs can be accomplished on the vehicle in a time equal to or less than door or seal remove and replace time.

Guidelines by Category (Cont'd)

Category No.	Category Title	Guideline No.	Guideline
3.02.06	Exhaust Exits, Nozzles, and Outlets	MC-01	All clamps should contain torque-set or torque-limiting connections to prevent clamp or component failure due to over-torque. Clamp installation call outs should not depend on special tools to establish the required torque values.
		MC-02	Avoid the use of cotter pins, safety wire, safety clips, and similar devices to prevent maintenance-induced events leading to ground vehicle accidents or loss of air vehicles.
		MC-05	Avoid potential foreign object traps during manufacturing or operational maintenance by eliminating vertical penetrations of plumbing/fittings into tanks, compartments, or cells
		MC-06	Locate, position, orient all plumbing and duct electrical connectors to prevent the need for sequential installation or removal.
		MC-14	Where multiple connectors are located in close proximity, ensure (1) a minimum hand tool arc of 120 degrees can be maintained, and (2) stagger fittings to ensure firm coupling interface/hand tool interface can be accomplished without inducing damage to adjacent lines.
		P-01	Access door and panel fastener types for airborne vehicles should meet the following criteria: <ul style="list-style-type: none"> - use latches for a frequency of access of 0 to 40 flight hours - use High Strength Quick Release fasteners for a frequency of access of 40-400 flight hours - use structural screws for a frequency of access of 400 flight hours or more
		P-02	Access door and panel fastener types for surface vehicles should meet the following criteria: <ul style="list-style-type: none"> - use a spring loaded or latch fastener for an opening frequency of daily - use a one quarter turn fastener (or equivalent) for a opening frequency of weekly - use screws or bolts for all other cases
		P-03	All doors and panels subject to environmental elements should contain form-in-place seals (or equivalent) attached to the door structure, not substructure, to prevent damage during maintenance.
		P-04	Door and panel seals should be compatible with all types of on-board servicing fluids, de-ice and anti-ice fluids, and all fluids used for chemical, biological, and nuclear decontamination.
		P-05	Piano type hinges should not be used on doors or panels because they are subject to wear, corrosion, and sand and fluid entry.
		P-06	Access door and panel devices used to support door in opened position should meet the following criteria: <ul style="list-style-type: none"> - for airborne vehicles, design for 60 knot gust loads (or equivalent jet blast loads) - for ground vehicles, design for 50 mph gust loads
		P-07	Hinged access doors and panels capable of remaining in the opened position should not have sharp edges or corners.
		P-08	Removable access door and panel fasteners should be of identical grip length and diameter.
		P-09	Acceptable door and panel hold-open devices include over-center sheet metal spring, over-center spring link, spring cartridge, support strut, and pinned goose neck hinge.
		P-10	Access doors and panels requiring non-captive fasteners should not be located forward of air inlet ducts or high-energy rotating components (e.g., prop fans, engine cooling fans, etc.).
		P-11	Access doors and panels should be interchangeable as justified by operation and support costs or life cycle costs.
		PYRO-26	Do not locate ammunition loader interfaces close to inlets, exhausts, fuel dumps and drains, antennas, sensors, lights, or hazardous protrusions.
		SABCH-06	Structural design should avoid the potential of dissimilar material or fastener corrosion.
		SABCH-07	No structural fasteners should be used that require special tools for installation.
		SABCH-08	Taper pins should be threaded and retained with self-locking hardware.
		SABCH-09	Pins and collars (lockbolts) should only be used in applications which do not normally require removal.
		SABCH-10	Do not use lockbolts in composites.
		SAFE-01	Drag chute installation designs not containing electrical safing should contain remote safe/arm provisions reachable from ground level by 5 percentile females. Remove location should be clear of engine exhaust areas and flight control deflection envelopes.

Guidelines by Category (Cont'd)

Category No.	Category Title	Guideline No.	Guideline
3.02.06	Exhaust Exits, Nozzles, and Outlets	T-01	Do not locate pyro, gas, and air (PGA) control system exhaust exits: - In proximity to safe, arm, or servicing areas, - Adjacent to auxiliary inlets, - In close proximity to crew boarding areas, weapons, emergency ingress/egress areas, and optics or optical glass. Design pyro type thruster exits associated with emergency use or backup with simple exit closure devices to identify if a thruster has been fired.
		T-02	Provide protective screens for PGA exits that normally remain open to prevent intrusions from fowl or wildlife.
		T-03	Provide protective closure provisions for PGA exits located or oriented to exposure from the elements.
		T-04	Two-sided or two-surfaced access should not be required for access to equipment interfaces and hardpoints. The term two-sided infers top/bottom, left/right, front/back, or combinations thereof.
3.02.07	Inlets and Inlet Ducts	A-13	Structural design should provide good access to corrosion-prone areas for inspection and treatment.
		A-16	Use transparent windows, quick-opening covers, or openings without any cover to permit quick visual inspections where needed.
		A-18	Mission critical functions should be monitored by BIT.
		BIT-06	Use concurrent BIT to monitor system critical functions.
		BIT-09	The geometric aspects of structural design and interfaces should not result in any natural bathtubs.
		D&V-01	Closed structural sections subject to condensation or fluid migration should contain drainage provisions.
		D&V-02	Crew cabs, operators' compartments, crew stations, cockpits, and passenger compartments should be subject to the same corrosion prevention measures as the exteriors of the vehicles. Low points, pockets, and related fluid collection points within should be provided with low point drains.
		D&V-03	Design air inlets, outlets, and exhausts to be accessible without reliance on ladders or work stands for ease of installing protective plugs or covers.
		ECS-11	Design air inlets, outlets, and exhausts with screens to prevent bird or rodent entry.
		ECS-12	Design air inlets, outlets, and exhausts to be meniscus-free to prevent a bathtub effect. In remote instances where this is not possible, passive drains should be provided at all low points to prevent liquid accumulation with the vehicle in its normal static attitude.
		ECS-13	Instances where air inlets, outlets, and exhausts are subject to water entry, passive drains should be employed capable of handling 4" of rain per hour.
		ECS-14	Locate and orient air inlets, outlets, and exhausts in a manner that prevents their use as footholds during maintenance.
		ECS-15	Install and orient air supply and distribution ducts so they clear all access openings and equipment removal envelopes.
		ECS-28	Provide surface sensors on equipment located in compartments containing louvers, screens, flush inlets, or similar openings to the environment to indicate the presence of chem/bio contaminants.
		EDECOM-01	Provide integral sensors (viewable from the exterior) for equipment subject to internal forced-air cooling from outside or external air to indicate the presence of contaminants.
		EDECOM-02	Design equipment surfaces and structure to be compatible with all decontamination agents and methods.
		EDECOM-03	Provide passive overboard drains in compartments subject to decontamination processes to void the area of contaminants.
		EDECOM-04	Provide hoist, lift or transport handles for equipment requiring removal from the host vehicle for decontamination. In instances where this may not be practical, design the equipment with hardpoints for attaching parasitic carrying provisions jeopardizing loss of the vehicle.
		EDECOM-05	The engine cavity structure should be capable of withstanding a 2000-degree Fahrenheit fire for 10 minutes without jeopardizing loss of the vehicle.
		ENG-22	All engine borescope provisions should be accessible with the engine installed and hooked up.
		ENG-23	No rigging or calibration should be required following engine replacement.
		ENG-27	No engine operational start and checkout should be required following engine replacement.
		ENG-28	No functional check flight should be required following engine change. On twin engine aircraft where both engines were changed simultaneously, a functional test flight is permissible.
		ENG-29	Attach engine-to-inlet duct interface seals to the vehicle so they can be left in place during engine removal.
		ENG-42	

Guidelines by Category (Cont'd)

Category No.	Category Title	Guideline No.	Guideline
3.02.07	Inlets and Inlet Ducts		
		ENG-43	Design engine-to-inlet duct seal so the interface is automatic during engine installation without needing any form of alignment, adjustment, or mechanical attachment interface.
		ENG-44	Select engine-to-inlet duct seal material to ensure seal life is sufficient for the life of the vehicle.
		ENG-47	Design the engine, including all accessories, plumbing, wiring, ducts, and mechanisms, to meet the same environmental protection and compatibility requirements as the host vehicle.
		ENV-01	Materials, treatments, coatings, finishes should be compatible with all anti-ice and de-ice fluids, chemical and biological decontamination fluids, washing and cleaning fluids, and all vehicle subsystem fluids.
		ENV-02	There should be no top coat or treatment deterioration throughout the standard temperature and humidity spectrum.
		ENV-03	For airborne vehicles, the finishes should be durable against rain, hail, and dynamic erosion throughout the flight envelope.
		ENV-04	For airborne and ground vehicles, the finishes should be durable against sand erosion throughout all surface wind speeds experienced in arid or desert geographical locations.
		ENV-05	For airborne vehicles, materials and all finishes with the engine inlet should be durable against hammer shock and compressor stalls.
		ENV-06	For ground vehicles, the finishes should be compatible with and durable against all rain, hail, sleet, snow, and ice conditions experienced in all intended operational environments.
		F-01	Use blind fasteners only where absolutely necessary or where considerable cost can be saved.
		F-02	Minimize access fasteners while making them quick release, easily removed and replaced, and captive.
		F-03	Choose fasteners based on the requirement to operate by hand or with common hand tools rather than special tools.
		F-04	Whenever possible, incorporate barrel type fasteners as opposed to hi-torque fasteners. Failure of Hi-torque fasteners due to stripping are common and a source of potential foreign object damage (FOD).
		IN(V)-02	Do not use loose structural fasteners in the access area to inlet door actuators and mechanisms. Where this guideline cannot be followed, design the actuator door to be accessible only when the inlet doors are fully closed.
		IN(V)-03	For engine inlet bellmouth fairings, use methods of retention other than fasteners. Latches may be considered as an acceptable alternative only if latch-to-panel retention is from the inner mold line.
		IN(V)-04	Design inlet doors and inlet bellmouth fairings to be fully interchangeable to eliminate the need to cut, file, or trim at the engine face.
		IN(V)-05	Locate the inlet duct edge a minimum of 60 inches from the cockpit or crew station to eliminate restricting engine operation to canopy-closed conditions.
		IN(V)-06	Use captive fasteners on all access doors forward of the inlet to significantly reduce engine FOD potential.
		IN(V)-07	Ensure that no ground safety pins or streamers are used forward of the inlet or within a 3-foot radius aft of the inlet.
		IN(V)-08	Incorporate an inlet closure door sealing concept that prevents entry of fluid, dust, or sand across the entire airborne and ground environment spectrum.
		IN-01	Low Observable (LO) engine face frames should be within 10 inches of the first stage fan or compressor blades.
		IN-02	Openings throughout the engine face frame should be sufficient to perform a 100% FOD inspection of the engine face.
		IN-03	Openings throughout the engine face frame should be sufficient to permit minor blending or repair of FOD without removing the engine.
		IN-04	For frames not integral with the engine, frame removal should be achievable from the engine cavity.
		IN-05	Both integral and remote engine front frames should be interchangeable.
		IN-06	Front frame anti-ice and de-ice provisions should give preference to engine hot bleed air.
		LG-30	Do not use landing gear wells to locate any type of auxiliary air inlet.
		LO-05	Do not locate flush mounted LO screens for auxiliary air inlets and exits in walkway areas unless durability has been proven.
		LO-06	Size flush mounted LO screens for auxiliary air inlets and exits to ensure functionality with up to 25 percent of the openings plugged.
		LO-07	Flush and non-flush LO screens should be interchangeable.

Guidelines by Category (Cont'd)

Category No.	Category Title	Guideline No.	Guideline
3.02.07	Inlets and Inlet Ducts	MATL-02	Cosmetic type repairs should not exceed 1 hours including cure or drying times.
		MATL-03	Cosmetic and vehicle repair material shelf life should not be less than 24 months.
		MATL-04	Cosmetic and vehicle repair materials should be non-proprietary and non-single source.
		MATL-05	Cosmetic and vehicle repair materials should not require refrigeration or special facilities or atmospheres for storage.
		MATL-06	Repair criteria, repairs, and instructions should not be classified.
		MATL-07	All cosmetic touch-up and repair materials should be environmentally safe.
		MATL-08	Repairs (other than major depot repair) should not require autoclave type facilities.
		MATL-09	A high degree of durability should be achieved across all walkway areas on the top surfaces of all vehicles up to and including 95 percentile personnel.
		MATL-10	Coatings and finishes should be durable against the effects of missile gases, velocities, and particles emanating from the missile motor.
		MATL-11	Coatings and finishes should be durable against the effects of gun gases, projectile shock waves, and brass particles emanating from the projectile seal rings.
		MATL-12	Leading edge materials and coatings should be durable against fragments from frangible gun port plugs.
		MATL-13	Special handling or shipping requirements of repair materials should be avoided.
		MATL-15	Doors and panels containing blade seals used for signature reduction should be interchangeable or contain interchangeable blade seals. Deviation is acceptable where repairs can be accomplished on the vehicle in a time equal to or less than door or seal remove and replace time.
		MC-02	Avoid the use of cotter pins, safety wire, safety clips, and similar devices to prevent maintenance-induced events leading to ground vehicle accidents or loss of air vehicles.
		MC-05	Avoid potential foreign object traps during manufacturing or operational maintenance by eliminating vertical penetrations of plumbing/fittings into tanks, compartments, or cells
		P-01	Access door and panel fastener types for airborne vehicles should meet the following criteria: <ul style="list-style-type: none"> - use latches for a frequency of access of 0 to 40 flight hours - use High Strength Quick Release fasteners for a frequency of access of 40-400 flight hours - use structural screws for a frequency of access of 400 flight hours or more
		P-02	Access door and panel fastener types for surface vehicles should meet the following criteria: <ul style="list-style-type: none"> - use a spring loaded or latch fastener for an opening frequency of daily - use a one quarter turn fastener (or equivalent) for a opening frequency of weekly - use screws or bolts for all other cases
		P-03	All doors and panels subject to environmental elements should contain form-in-place seals (or equivalent) attached to the door structure, not substructure, to prevent damage during maintenance.
		P-04	Door and panel seals should be compatible with all types of on-board servicing fluids, de-ice and anti-ice fluids, and all fluids used for chemical, biological, and nuclear decontamination.
		P-05	Piano type hinges should not be used on doors or panels because they are subject to wear, corrosion, and sand and fluid entry.
		P-06	Access door and panel devices used to support door in opened position should meet the following criteria: <ul style="list-style-type: none"> - for airborne vehicles, design for 60 knot gust loads (or equivalent jet blast loads) - for ground vehicles, design for 50 mph gust loads
		P-07	Hinged access doors and panels capable of remaining in the opened position should not have sharp edges or corners.
		PYRO-26	Do not locate ammunition loader interfaces close to inlets, exhausts, fuel dumps and drains, antennas, sensors, lights, or hazardous protrusions.
		SABCH-01	Do not locate auxiliary air inlets, sensors, access doors, or drains in boundary bleed areas.
		SABCH-02	All flush type structural screws should have identical head drives for the entire vehicle.
		SABCH-03	All non-flush type structural screws should have identical head drive recesses for the entire vehicle.

Guidelines by Category (Cont'd)

Category No.	Category Title	Guideline No.	Guideline
3.02.07	Inlets and Inlet Ducts	SABCH-04	Special high strength bolts, such as twelve-point heads, should be fully justified from standpoint of the cost of ownership and effectiveness.
		SABCH-05	Structural design should avoid the reliance on blind fasteners unless fully supported by cost, weight, schedule, and effectiveness analysis.
		SABCH-11	In rare instances where the use of dissimilar material in immediate contact cannot be avoided, they should be sufficiently insulated to endure for the life of the vehicle.
		SABCH-12	Avoid tapping threads into structural members. Use of heli-coil type or similar insert concepts is permissible.
		SABCH-13	No structural design concept should rely on frequent scheduled inspections to monitor or otherwise ensure structural integrity.
		SABCH-14	No structural fastener intended to carry shear or tension loads should be smaller than 1/4" diameter (.25").
		SABCH-15	Give preference to butt type splices over lap type splices in the design of manufacturing splices.
3.02.08	Electrical	A-11	Locate compartment electrical penetrations close to the access opening for ease of sight, probing, repair, and to eliminate fluid soaking, wicking, or contamination.
		A-12	Locate compartment electrical penetrations far enough from the access opening to prevent damage resulting from improper (over-length) panel fasteners.
		A-13	Two-sided or two-surfaced access should not be required for access to equipment interfaces and hardpoints. The term two-sided infers top/bottom, left/right, front/back, or combinations thereof.
		BIT-01	During design of the BIT, use worst-case stress analysis to ensure that any circuit failures induced by temperature extremes, tolerance build-up, power supply variations, and combinations thereof are identified.
		BIT-02	Ensure that BIT system thresholds are consistent with those across the system, subsystem, item, module, and piece-part levels to prevent excessive numbers of Cannot Duplicate (CND) and Retest OK (RTOK) events from occurring.
		BIT-03	The degree of BIT required or proposed should be based on the respective failure rates and the appropriate FMECA at all equipment indenture levels.
		BIT-04	Limit the amount of data that is recorded to a manageable size by: <ul style="list-style-type: none"> - Limiting the number of signals that are monitored - Limiting the maximum sampling rate - Reducing the time span over which data is accumulated - Restricting the type of data accumulated
		BIT-05	Incorporate testability design features as an integral part of equipment preliminary design process.
		BIT-06	Mission critical functions should be monitored by BIT.
		BIT-09	Use concurrent BIT to monitor system critical functions.
		BIT-26	Locate routinely used test points so they are accessible without removing or disassembling other equipment
		BIT-27	Periodic and initiated BIT should detect at least 98% of all failures and isolate a minimum 99% of those failures detected to a single LRU or WRA.
		BIT-28	Design BIT to have the same level of EMI protection as the system or equipment being monitored.
		CC-01	Use fiber-optic technologies in preference to conventional interconnect concepts to reduce the number of interconnects/interfaces, reduce manufacturing and ownership costs, and significantly improve R&M.
		CC-02	Standardize connector and wire types to improve testability and logistic support. Keep the number of "different" standard connectors to a minimum. Use the same connector type keyed differently where possible.
		CC-03	Provide clearance around connectors for engagement/disengagement of cables and proper connector orientation under anticipated environmental conditions (e.g., bare hand of 50 percentile male in an enclosed or protected environment and a gloved hand of a 50 percentile male in an open or unprotected environment).
		CC-04	Use quick release cables and locate cables to make removal and replacement easy and to avoid having to remove one cable to gain access to another. Provide adequate space for cables, including sleeving and tie-downs, and adequate service loops for ease of assembly/disassembly
		CC-05	Orient and space connectors to allow a sufficient grip on the connector for cable or wire extraction without fear of using the wiring or cable for additional leverage.

Guidelines by Category (Cont'd)

Category No.	Category Title	Guideline No.	Guideline
3.02.08	Electrical	CC-06	Label, and where possible color code, each wire in a harness or cable to facilitate tracking from origin to termination. Each wire, cable, and coax-to-connector interface should be provided with a source of identification to aid in trouble shooting, repair, or modification. Marking the cable designator on the cable along with bar codes is also recommended.
		CC-07	Do not manufacture or dress connectors containing more than 25 wires or cables as a single integrated harness. Group the wires or cables into runs of no more than 25 wires or cables each. In addition to making trouble shooting and repair easier, this approach help avoid large bend radii, thereby simplifying routing, packaging, and stowage.
		CC-08	Standardize connector pin assignments for power, ground, and other frequently used signals.
		CC-09	Locate LRU/subsystem critical nodes (and or test points) so they are accessible from a connector to prevent the need for internal LRU probing or access.
		CC-10	Avoid hidden cables. Visually inspecting and tracing all assembly cables rather than having hidden cables (such as behind other cables or even LRUs) allows for a quick system and cable integrity check which aids in overall system integrity and debug. This also implies quick access for manipulative actions.
		CC-11	Orient spare wires and cable pigtailed along the outer diameter or periphery of connectors to make access easier.
		CC-12	Build up and assemble straight and angle connector shells or back shells in a manner that ensures that wire or cable strain or wear is not possible.
		CO-01	Design automated systems and programs with provisions to enable "stop test" and "resume" without the need to cycle back or repeat the entire test.
		CO-02	In the event of program loss or hang-up, automated systems and programs should have provisions for reverting to manual test and operation.
		CO-03	Use a test connector to provide test and maintenance bus access to all system and subsystem faults.
		CO-04	Design systems and subsystems so that ATE can be used to access, read, and control internal components in concert with the test or checkout program.
		CO-05	Avoid the need for costly adapters for signal communications between system, subsystems, line replaceable units (LRUs) or Weapon Replaceable Assemblies (WRAs), and ATE.
		EC-01	A threaded electrical connector should contain integral locking mechanisms and visual indications that the connector is properly seated and locked.
		EC-02	An electrical connector requiring less than one full turn to connect or disconnect should contain integral locking mechanisms and visual indications that the connector is properly seated and locked.
		EC-03	A push-pull electrical connector (excluding rack-and-panel type) should contain integral locking features and visual indication that the connector is properly seated and locked.
		EC-04	All electrical connectors should be keyed or asymmetrically shaped to ensure proper alignment.
		EC-05	All electrical connectors should contain scoop-proof shells to ensure pin damage will not occur prior to engaging key way.
		EC-06	All electrical connectors should be corrosion resistant to reduce or eliminate the need for scheduled inspections or corrosion prevention measures.
		EC-07	Avoid using electrical connectors requiring any type or form of soldering.
		EC-08	Locate and position electrical connectors such that all pin identification for either half can be easily seen.
		EC-09	Electrical connectors selected for critical applications on ground vehicles should be both accessible and capable of being connected disconnected by a fifty percentile gloved male hand.
		EC-10	Separation between grouped electrical connectors should be sufficient to ensure make or break of any connector by a fifty percentile gloved male hand. Where this is not possible, an alternate method should be used such as the use of stand-offs, long-shelled connectors, alternated with standard connectors, 180-degree connectors alternated with 90-degree connectors, or innovative equivalents.
		EC-16	Select connectors so that contacts on the "live" or "hot" side of the connection are socket type rather than pin type to minimize personnel hazard and to prevent accidental shorting of live circuits.
		EC-17	Whenever possible, use self-locking connector plugs of a type not requiring safety wire.
		EC-18	All electric connectors should be environment resistant.

Guidelines by Category (Cont'd)

Category No.	Category Title	Guideline No.	Guideline
3.02.08	Electrical	EC-19	Connectors containing fiber optic contacts should, whenever possible, be mounted on a vertical surface to prevent particle and fluid contamination.
		EC-20	Use quick disconnect connectors where allowed and identify all pins on each connector.
		EC-21	Locate connectors far enough apart so that they meet specified requirements.
		EC-22	All connectors should be keyed differently with aligning pins that extend beyond the electrical pins. Connector pins and sockets should engage after key position is entered.
		EC-23	Design connectors so that plugs are cold and receptacles are hot.
		EC-24	Use electrical connectors that incorporate alignment key-ways to reduce incidents of damage due to improper engagement.
		EC-25	Use positive locking, quick disconnect electrical connectors to save man-hours, prevent foreign object damage (FOD) and decrease the chance of personal injury.
		EC-26	Avoid using identical electrical connectors in adjacent areas.
		ECS-06	All electrical control, sensing, sensor, warning, caution, or signal interface and wiring should be fully BIT compatible.
		EG-01	Design feedback loops so that the loop can be broken during test to ensure that faults do not propagate to the point where they cannot be isolated.
		EG-02	Avoid using external feedback loops requiring complex circuitry to simulate feedback I/Os.
		EG-03	In rare instances when complex external feedback loops cannot be avoided, incorporate simple interruptible control points.
		EG-04	Avoid long sequences of vectors to initialize or alter device outputs to minimize potential testability problems.
		EG-05	Avoid the need to have test equipment generate complex, phased or time related signals.
		EG-06	Test points should be located on all circuit nodes that are useful in determining the module's health.
		EG-07	Test points should be designed so that functional circuitry cannot be damaged or degraded due to the routing or accidental shorting of a signal at a test point. Some type of test point isolation technique should be used (buffers, isolator, etc.).
		EG-08	Test points should be easily accessed and clearly marked.
		EG-10	Design redundant circuits to be independently testable to ensure errors are not masked.
		EG-11	To improve the probability of fault detection, avoid shorting signals together to achieve a specific test function or condition.
		EG-12	Incorporate concept for partitioning module functions to simplify test equipment or eliminate the need for ancillary test equipment.
		EG-13	Design oscillators or clocks that are resident on the module to be replaceable by a signal from a connector to avoid the need to synchronize ATE to on-board signals.
		ENG(G)-18	Incorporate appropriate sensors to enhance the diagnostic and prognostic capabilities for the following: <ul style="list-style-type: none"> - Oil temperature - Oil pressure - Oil filter bypass - Oil cooler bypass valve position - Oil level - Oil return line particle count
		ENG(G)-20	Design all firewall fittings, connectors, and penetrations to be fully viewable and directly accessible to the maintainers.
		ENG-24	Replacement of all ignitors should be possible with the engine installed.
		ENG-25	All engine-to-airframe plumbing, wiring, and duct interfaces should be capable of being connected or disconnected by hand, should contain integral safety provisions, and should not require torquing.
		ENG-26	Locate and position engine overheat and fire warning sensors so that damage cannot occur during engine maintenance or replacement.
		ENG-46	Design the basic engine and engine-mounted accessory interface so that no fluid traps or bathtubs exist regardless of engine-mounted accessory location.

Guidelines by Category (Cont'd)

Category No.	Category Title	Guideline No.	Guideline
3.02.08	Electrical	ENG-47	Design the engine, including all accessories, plumbing, wiring, ducts, and mechanisms, to meet the same environmental protection and compatibility requirements as the host vehicle.
		LG-11	All microswitches, proximity switches, lights, sensors, etc. mounted to a strut should have individual interface connectors. Wiring pigtails requiring in-line splices should be avoided.
		LG-14	All interfaces from the airframe to the struts should be visible and accessible, and not require removal of airframe structure for access.
		LG-21	Proximity type switches used in landing gear design should meet a minimum of 200 volt-amperes to eliminate Electromagnetic Interference (EMI) or Radiation Hazard (RADHAD) problems. Wiring associated with the landing gear design should meet the same requirements.
		MC-02	Avoid the use of cotter pins, safety wire, safety clips, and similar devices to prevent maintenance-induced events leading to ground vehicle accidents or loss of air vehicles.
		MC-06	Locate, position, orient all plumbing and duct electrical connectors to prevent the need for sequential installation or removal.
		MC-10	In rare instances where a plumbing run contains complex form or geometry that would require removal of other plumbing or equipment for access, in-line connectors should be incorporated to maintain the integrity of other plumbing or equipment.
		MC-12	All plumbing and connectors containing liquids should be meniscus-free.
		MC-14	Where multiple connectors are located in close proximity, ensure (1) a minimum hand tool arc of 120 degrees can be maintained, and (2) stagger fittings to ensure firm coupling interface/hand tool interface can be accomplished without inducing damage to adjacent lines.
		MG-01	Mount LRUs/sub-systems on drawer slides or extender racks to provide easier accessibility during integration, testing, debug, and repair of Units Under Test (UUTs).
		PYRO-21	Weapon bays should contain internal lighting controlled by a separate switch that is only functional when doors are open
		SIMP-01	Location and design of all exterior lights should not require protective covers in ground environments.
		SIMP-02	Landing and taxi lights should be mounted on landing gear struts or doors to eliminate separate compartments, doors, and retraction/extension mechanisms.
		SURV-04	Do not seal battery power or battery-operated devices in survival packages or containers. When this guideline cannot be followed, provide a remote way of ascertaining the status or condition of the battery.
		W-01	Hat section type structural stiffeners with sufficient cross sectional area should be considered as a routing tunnel for wiring and coax.
		WT&B-08	Do not use microswitches (mechanical) in gear caution and warning systems.
		WT&B-16	Do not use potting compounds for electrical connector environmental protection because it tends to revert and significantly increases repair time.
		WT&B-17	Electrical connector environmental protection should be capable of withstanding water pressure streams up to 120 psi encountered during decontamination, wash, etc.
3.03	Structures	A-08	Plumbing penetrations into a compartment should not be on a vertical axis due to difficulty in making or breaking vertically-oriented connections. When compartment access is from the bottom, vertically-oriented connections can allow fluid to leak onto the maintainer. When access is from the top, such connections can allow foreign matter to enter the line. Use horizontal penetrations whenever possible.
		A-09	Any heat or temperature sensitive structure within a compartment should contain heat-sensitive tape or appropriate heat sensor for easy indication of over-temperature excursions.
		A-10	Provide a sufficient number of compartment fluid drains to ensure fluid drainage for varying aircraft static attitudes and varying terrain slopes for ground vehicles.
		A-11	Locate compartment electrical penetrations close to the access opening for ease of sight, probing, repair, and to eliminate fluid soaking, wicking, or contamination.
		A-12	Locate compartment electrical penetrations far enough from the access opening to prevent damage resulting from improper (over-length) panel fasteners.

Guidelines by Category (Cont'd)

Category No.	Category Title	Guideline No.	Guideline
3.03	Structures	A-13	Two-sided or two-surfaced access should not be required for access to equipment interfaces and hardpoints. The term two-sided infers top/bottom, left/right, front/back, or combinations thereof.
		A-15	Locate tie-down attachment points such that tie-down chains, straps, or cables do not prevent or restrict normal servicing, weapon loading, or safe/arm functions.
		A-17	All structural fasteners in an access door or panel should be of identical grip and diameter. In rare cases where this is not possible, fasteners of different grip must have different diameters to prevent a shorter fastener being substituted for the correct, longer fastener.
		A-18	Use transparent windows, quick-opening covers, or openings without any cover to permit quick visual inspections where needed.
		AA&S-01	Flush mounted antennas, sensors, and air data devices should have a good color contrast to surrounding structure when located in walkway areas.
		AA&S-02	Closure and sealing of cavities, compartments, and wells for retractable antennas should be mechanized to function as part of the extend and retract cycle.
		AA&S-03	Closure and sealing of cavities, compartments, and wells for retractable antennas should be maintained when antennas are not installed without need for ancillary measures or equipment.
		AA&S-04	LO antennas should be designed to be tolerant of accumulations of grime or dirt without degrading performance or biasing the BIT/fault isolate performance.
		AA&S-05	Multi-function antennas, arrays, and sensors located in leading edges should be modularized to reduce vehicle downtime through simplified replacement of a faulty module.
		AA&S-06	Moveable flaps or slats containing integral antennas, arrays, or sensors should be interchangeable to provide the option for on-vehicle or off-vehicle repair.
		ARM-01	For an aircraft, the fuselage lower shear moldline should be no less than 38" above the ground when external weapons only will be carried on the fuselage.
		ARM-02	For an aircraft, the fuselage lower shear moldline should be no less than 50" above the ground when internal weapons will be carried in the fuselage and weapon bay door widths exceed 22".
		ARM-03	Locate fuselage weapon bays a minimum of 18" from the nose landing gear and main landing gear of an aircraft.
		ARM-04	No single weapon/store mounted on a transporter should intrude into the service/tumaround envelope of another station.
		ARM-05	All servicing and tumaround functions (including movement envelopes) should be outside the gun firing envelope.
		ARM-06	The relationship of the nose landing gear to the main landing gear should not restrict the positioning of weapon transporters under the fuselage of an aircraft.
		ARM-10	Weapon and store stations should be located to ensure vehicle ballasting will not be required under any combination of weapon/store configurations.
		BIT-05	Incorporate testability design features as an integral part of equipment preliminary design process.
		BIT-06	Mission critical functions should be monitored by BIT.
		BIT-09	Use concurrent BIT to monitor system critical functions.
		BIT/BITE-02	Design EMI protection to eliminate finger type EMI contact devices.
		C-01	Avoid swivel type connectors and fittings for air, fuel, or hydraulic line interfaces due to their history of low reliability.
		C-02	Provide spacing between parallel plumbing runs so that in-line couplings can be replaced without removing lines or disconnecting any line support devices.

Guidelines by Category (Cont'd)

Category No.	Category Title	Guideline No.	Guideline
3.03	Structures	CARGO-01	<p>Ground vehicles with storage bays or compartments accessible from outside the vehicle should:</p> <ul style="list-style-type: none"> - Have the door sill located no lower than knee height to accommodate a wide range of percentiles while standing. - Ensure door handles are flush with outer surface to protect personnel. - Contain goose neck hinges to protect the hinge from the elements. - Contain peripheral door seals that will protect against blowing sand entry at 50 mph. - Ensure door can be opened with transport tie downs installed. - Ensure door opening envelope does not intrude into the opening envelope of an adjacent door. - Contain simple sheet metal hold-open spring or mechanism. - Ensure floor of bay or compartment is flush with sill to simplify cleanout and drainage. - Ensure door unlocking and opening mechanism can be actuated by a 95 percentile male hand while wearing arctic gloves. - Contain 15 percent added volume for density growth.
		CARGO-02	<p>Ground vehicles with small exterior storage bays or compartments containing emergency equipment or supplies should:</p> <ul style="list-style-type: none"> - Be located at chest height of the 50 percentile male. - Contain unlatching mechanisms activated by pushing inward on the door. - Meet all other generic bay and compartment requirements.
		CBR-01	<p>Orient all vehicle liquid servicing fittings to ensure fluids will not come in contact with protective garb during connect/disconnect activities.</p>
		CBR-02	<p>Ensure vehicle overboard passive liquid drains are clearly marked or visible to enable personnel to remain clear of area.</p>
		CBR-03	<p>Design fuel cell drains so they can not be activated in a manner that would allow fuel to come in contact with a protected hand.</p>
		CBR-04	<p>Design emergency ingress provisions so they can be activated by a 95 percentile male wearing full protective chemical or biological protection gear.</p>
		CBR-05	<p>Size rescue doors, panels, and "cut here" areas to accommodate the 95 percentile shoulder width wearing full protective chemical or biological protection gear.</p>
		CBR-06	<p>Consider the reduction in peripheral vision resulting from wearing chemical or biological protection gear when designing intended fire paths and crash rescue paths into a vehicle.</p>
		CREW-01	<p>Canopy attachment/hinge hardpoints should be located on the same structural subassembly as the canopy locking hardpoints.</p>
		CREW-02	<p>Armor protection integrated with the vehicle structure should be given preference over parasitic armor.</p>
		CREW-03	<p>In rare cases where armor is parasitic, armor should be interchangeable and easily installed.</p>
		CREW-04	<p>Avoid wiring, coax, and plumbing penetrations through the floor of crew cabs, operators' compartments, crew stations, cockpits, and passenger compartments.</p>
		CREW-05	<p>Structural instrument panels, dashboards, and control panels should be modularized for easy and adequate access to all interfaces, to simplify manufacturing, and to reduce maintenance-induced problems.</p>
		CREW-12	<p>Requirements for boresighting should not be part of the design or integration.</p>
		CREW-13	<p>Provide storage provisions in each vehicle type (ground and airborne) to store extra tapes, modules, cassettes, as appropriate to the intended vehicle use/mission.</p>
		D&V-01	<p>The geometric aspects of structural design and interfaces should not result in any natural bathtubs.</p>
		D&V-02	<p>Closed structural sections subject to condensation or fluid migration should contain drainage provisions.</p>
		D&V-03	<p>Crew cabs, operators' compartments, crew stations, cockpits, and passenger compartments should be subject to the same corrosion prevention measures as the exteriors of the vehicles. Low points, pockets, and related fluid collection points within should be provided with low point drains.</p>
		ECS-11	<p>Design air inlets, outlets, and exhausts to be accessible without reliance on ladders or work stands for ease of installing protective plugs or covers.</p>
		ECS-12	<p>Design air inlets, outlets, and exhausts with screens to prevent bird or rodent entry.</p>

MIL-HDBK-470A

APPENDIX C

Guidelines by Category (Cont'd)

Category No.	Category Title	Guideline No.	Guideline
3.03	Structures	ECS-13	Design air inlets, outlets, and exhausts to be meniscus-free to prevent a bathtub effect. In remote instances where this is not possible, passive drains should be provided at all low points to prevent liquid accumulation with the vehicle in its normal static attitude.
		ECS-14	Instances where air inlets, outlets, and exhausts are subject to water entry, passive drains should be employed capable of handling 4" of rain per hour.
		ECS-15	Locate and orient air inlets, outlets, and exhausts in a manner that prevents their use as footholds during maintenance.
		ECS-16	All components contained in the systems, including all attaching brackets and supports, should use hex-head self-locking bolts for ease and simplicity of installation.
		ECS-17	Do not use air ejectors due to their low reliability and susceptibility to clogging.
		ECS-21	Do not locate ground cooling or circulation fans that operate at high noise levels in operator, crew, or passenger compartments.
		EDECOM-01	Provide surface sensors on equipment located in compartments containing louvers, screens, flush inlets, or similar openings to the environment to indicate the presence of chem/bio contaminants.
		EDECOM-02	Provide integral sensors (viewable from the exterior) for equipment subject to internal forced-air cooling from outside or external air to indicate the presence of contaminants.
		EDECOM-03	Design equipment surfaces and structure to be compatible with all decontamination agents and methods.
		EDECOM-04	Provide passive overboard drains in compartments subject to decontamination processes to void the area of contaminants.
		EDECOM-05	Provide hoist, lift or transport handles for equipment requiring removal from the host vehicle for decontamination. In instances where this may not be practical, design the equipment with hardpoints for attaching parasitic carrying provisions
		ENG(G)-01	Provide access to all engine mounts for ground vehicles so that hoisting or crawling under the vehicle is not required.
		ENG(G)-02	Use torque-limiting bolts or torque washers as engine mount attaching hardware to eliminate the need for torque wrenches.
		ENG(G)-03	Design hard points for hoisting or positioning the engine during installation and removal to be integral to the engine and capable of hoisting and supporting a fully-built-up engine package.
		ENG(G)-04	Do not use downward engine removal concepts that require jacking or hoisting of the ground vehicle.
		ENG(G)-05	Use concepts for removing ground vehicle engines from the front, rear, or side rather than from overhead (using hoisting).
		ENG(G)-06	The distance between the engine and firewall should ensure the access envelopes to lines, fittings, wiring, and adjustments will accommodate the 75 percentile male hand.
		ENG(G)-07	The distance between the cooling fan and radiator core should ensure that access envelopes will not require removal of the core.
		ENG(G)-08	The interface of the engine assembly to the engine compartment and structure should be designed to ensure all spark plugs, glo-plugs, and igniters can be replaced within 30 minutes elapsed time.
		ENG(G)-10	Design attaching hardware for all mechanical engine-to-vehicle interfaces to be captive and with integral safeties.
		ENG(G)-16	Do not locate batteries in the engine compartment. In those instances where this is not possible: - The battery support structure should be of a material that is impervious to acid leakage or boil-over. - The battery support structure should serve as a scupper to collect and direct the acid out of the engine compartment.
		ENG(G)-19	Paint engine compartments gloss white to enhance light reflectivity and enhance fluid leak detection.
		ENG(G)-20	Design all firewall fittings, connectors, and penetrations to be fully viewable and directly accessible to the maintainers.
		ENG-09	On multi-engine air vehicles, the engines should be capable of being installed in any engine cavity without need for reconfiguration.
		ENG-10	On multi-engine air vehicles, the airframe-to-engine interfaces should be in identical positions or orientations for each engine cavity.
		ENG-15	Engine removal for aircraft intended to be operated off carriers should be accomplished within the shadow of the aircraft.
		ENG-16	Aircraft jacking should not be required for engine removal.

MIL-HDBK-470A

APPENDIX C

Guidelines by Category (Cont'd)

Category No.	Category Title	Guideline No.	Guideline
3.03	Structures		
		ENG-17	Aft engine removal should be an acceptable alternative for USAF aircraft.
		ENG-18	For either downward or aft engine removal, it should be possible to maintain control of the engine on all axis during the entire removal and installation process.
		ENG-19	The minimum clearance between engine and airframe should be 1 inch, including removal and installation.
		ENG-20	Do not locate equipment or components in the engine cavity except for those components associated with the engine or engine installation.
		ENG-21	Do not locate equipment or components in the engine bay cavity in a manner that would require removal or repositioning for engine removal.
		ENG-22	The engine cavity structure should be capable of withstanding a 2000-degree Fahrenheit fire for 10 minutes without jeopardizing loss of the vehicle.
		ENG-23	All engine borescope provisions should be accessible with the engine installed and hooked up.
		ENG-24	Replacement of all ignitors should be possible with the engine installed.
		ENG-25	All engine-to-airframe plumbing, wiring, and duct interfaces should be capable of being connected or disconnected by hand, should contain integral safety provisions, and should not require torquing.
		ENG-26	Locate and position engine overheat and fire warning sensors so that damage cannot occur during engine maintenance or replacement.
		ENG-30	It should not be necessary to close or reinstall engine access doors for engine ground operation up to and including military power.
		ENG-33	Engine access doors and panels and their integral support struts should be capable of withstanding 60 MPH winds in the opened position.
		ENG-34	Identification plates on the engine and all engine-mounted components should be viewable with the engine installed and engine access doors opened.
		ENG-42	Attach engine-to-inlet duct interface seals to the vehicle so they can be left in place during engine removal.
		ENG-43	Design engine-to-inlet duct seal so the interface is automatic during engine installation without needing any form of alignment, adjustment, or mechanical attachment interface.
		ENG-44	Select engine-to-inlet duct seal material to ensure seal life is sufficient for the life of the vehicle.
		ENG-45	Provide remote servicing points accessible from the ground to service engine accessories mounted on top of the engine (e.g., oil tanks, gear boxes, generators, etc.) to eliminate climbing upon or atop the host vehicle.
		ENG-47	Design the engine, including all accessories, plumbing, wiring, ducts, and mechanisms, to meet the same environmental protection and compatibility requirements as the host vehicle.
		ENG-48	Do not drain or dump residual fuel in the engine fuel control/manifold overboard. When it is not possible to follow this guideline, route the fuel to an engine-mounted collector tank capable of retaining fuel from two shutdowns.
		ENV-01	Materials, treatments, coatings, finishes should be compatible with all anti-ice and de-ice fluids, chemical and biological decontamination fluids, washing and cleaning fluids, and all vehicle subsystem fluids.
		ENV-02	There should be no top coat or treatment deterioration throughout the standard temperature and humidity spectrum.
		ENV-03	For airborne vehicles, the finishes should be durable against rain, hail, and dynamic erosion throughout the flight envelope.
		ENV-04	For airborne and ground vehicles, the finishes should be durable against sand erosion throughout all surface wind speeds experienced in arid or desert geographical locations.
		ENV-05	For airborne vehicles, materials and all finishes with the engine inlet should be durable against hammer shock and compressor stalls.
		ENV-06	For ground vehicles, the finishes should be compatible with and durable against all rain, hail, sleet, snow, and ice conditions experienced in all intended operational environments.
		EXH-01	Treatments required for engine hot sections and exhaust areas should not require scheduled removals for the purposes of recoating.

Guidelines by Category (Cont'd)

Category No.	Category Title	Guideline No.	Guideline
3.03	Structures	EXH-02	High temperature exhaust patterns should flow away from or be directed away from treated surrounding structure, coatings, or finishes.
		EXT-01	Locate Tanks, Pods, Containers, and Devices (TPCD's) so they do not block or restrict access to existing vehicle access areas or access approach envelopes.
		EXT-02	Design TPCD's for fuel containment to automatically interface to the host vehicle during installation or removal.
		EXT-03	Design TPCD's to be fully compatible with the existing vehicle built-in hoisting provisions and locking devices.
		EXT-05	Design access doors for cargo type TPCD's to be non-load carrying and with simple latches for all doors and panels.
		EXT-06	Design cargo TPCD's to ensure all cargo and equipment can be downloaded and uploaded with the TPCD installed on the host vehicle.
		EXTING-01	Use extinguishing concepts dedicated to each individual fire zone in preference to manifold systems operating from a central source.
		EXTING-03	Keep each individual fire zone over-temperature/fire warning system separate from those in other fire zones.
		EXTING-04	Design individual fire zone over-temperature/fire warning system to be fully BIT capable (the BIT concept should permit both initiated and periodic BIT).
		F-01	Use blind fasteners only where absolutely necessary or where considerable cost can be saved.
		F-02	Minimize access fasteners while making them quick release, easily removed and replaced, and captive.
		F-03	Choose fasteners based on the requirement to operate by hand or with common hand tools rather than special tools.
		F-04	Whenever possible, incorporate barrel type fasteners as opposed to hi-torque fasteners. Failure of Hi-torque fasteners due to stripping are common and a source of potential foreign object damage (FOD).
		FUEL-01	Locate fuel vent and dump masts to ensure exiting fuel will be clear of servicing, loading, arming and safing areas for all types of ground and airborne vehicles.
		FUEL-02	Manufacturing splices for major sub-assemblies should not intrude into or through integral fuel cells or tanks.
		FUEL-03	Structural bolts, screws, and fasteners should not penetrate into integral fuel cells or tanks other than those used for access door attachment.
		FUEL-04	Where the fuel wetted area inside a fuel cell or tank is void of blade, knife, and hat stiffeners for use as hardpoint attachment, standoffs bonded to the cell surface should be used as attachments for clamps, and brackets to eliminate fastener penetration of the fuel cavity.
		FUEL-05	Intersecting of two or more surfaces in a fuel wetted area of less than 90 degrees should be avoided to simplify manufacture and repair.
		FUEL-06	Where maintaining a minimum angle of 90 degrees is not possible, sufficient depth, width, and height should be maintained to provide tool clearances for all tools used in the manufacturing processes and in the operational field repair environment.
		FUEL-07	When feed tanks are designed such that the lower portion of the tank serves as a surge chamber, the top closure deck of the surge chamber should provide the strength to support the weight of a 95 percentile male.
		FUEL-08	The size and number of fuel cell and tank access doors should be sufficient to ensure no wetted area of the cell or tank is beyond a maximum 18" distance from the edge of the access opening. This guideline applies to only non-man rated cells.
		FUEL-09	All fuel cell or tank access doors not mounted on the exterior surface should contain sealing provisions other than the channel type.
		FUEL-10	Provide access from the wing closure ribs in lieu of the moldline when access is required in close proximity to the wing fold area.
		FUEL-11	Through-the-tank fasteners should not be used for fuel cells or tanks in areas where a leak path could be established into an inaccessible portion of the vehicle.
		HOOK-06	Avoid the need to remove the tail hook to facilitate engine access or removal.
		HOOK-07	Incorporate remote means to read the tail hook dampener pressure charge to enhance carrier suitability.

Guidelines by Category (Cont'd)

Category No.	Category Title	Guideline No.	Guideline
3.03	Structures	HYD-01	For military combat vehicles having two or more hydraulic power systems, provide a minimum 30-inch spacing between ground power and servicing interfaces to ensure: - Design flexibility in locating and arranging equipment in high-density vehicles such as fighters and helicopters, - Work area separation to enable concurrent service/maintenance on systems, - Systems vulnerability enhancement, - Reduction in turn-around and door actuation mechanisms so they not protrude into the air inlet flow field to eliminate FOD potential.
		IN(V)-01	Design inlet door actuators and door actuation mechanisms so they not protrude into the air inlet flow field to eliminate FOD potential.
		IN(V)-02	Do not use loose structural fasteners in the access area to inlet door actuators and mechanisms. Where this guideline cannot be followed, design the actuator door to be accessible only when the inlet doors are fully closed.
		IN(V)-03	For engine inlet bellmouth fairings, use methods of retention other than fasteners. Latches may be considered as an acceptable alternative only if latch-to-panel retention is from the inner mold line.
		IN(V)-04	Design inlet doors and inlet bellmouth fairings to be fully interchangeable to eliminate the need to cut, file, or trim at the engine face.
		IN(V)-05	Locate the inlet duct edge a minimum of 60 inches from the cockpit or crew station to eliminate restricting engine operation to canopy-closed conditions.
		IN(V)-06	Use captive fasteners on all access doors forward of the inlet to significantly reduce engine FOD potential.
		IN(V)-07	Ensure that no ground safety pins or streamers are used forward of the inlet or within a 3-foot radius aft of the inlet.
		IN(V)-08	Incorporate an inlet closure door sealing concept that prevents entry of fluid, dust, or sand across the entire airborne and ground environment spectrum.
		IN-01	Low Observable (LO) engine face frames should be within 10 inches of the first stage fan or compressor blades.
		IN-02	Openings throughout the engine face frame should be sufficient to perform a 100% FOD inspection of the engine face.
		IN-03	Openings throughout the engine face frame should be sufficient to permit minor blending or repair of FOD without removing the engine.
		IN-04	For frames not integral with the engine, frame removal should be achievable from the engine cavity.
		IN-05	Both integral and remote engine front frames should be interchangeable.
		IN-06	Front frame anti-ice and de-ice provisions should give preference to engine hot bleed air.
		LG-02	Hardpoints for attachment of landing gear trunnions should be capable of carrying all induced gear loads for the life of the airframe.
		LG-03	Hardpoints for attachment for landing gear trunnions should not be machined as an integral part of the airframe structure when normal design sink rates over 25 feet per second are required.
		LG-04	Do not use Beryllium and Beryllium base alloys in any location subject to wear or corrosive atmospheres or in installations where machining may be required.
		LG-06	Design struts, attachments, and interfaces so they do not depend on scheduled visual inspections, non-destructive inspection (NDI), or non-destructive test (NDT) to ensure the reliability or integrity of the system in the operational environment.
		LG-09	Use coiled tubing in lieu of flex lines or hoses for hydraulic line routing from the airframe to the strut.
		LG-14	All interfaces from the airframe to the struts should be visible and accessible, and not require removal of airframe structure for access.
		LG-15	No portion of the landing gear closure door(s) should be attached to the strut. In rare instances where this may not be possible, that attached portion should not require alignment or rigging.
		LG-16	No portion of the landing gear rigging process should require support equipment type templates, gauges, or tools. Indexes, reference points, etc., should be an integral part of the landing gear/airframe design.
		LG-17	Hydraulic, pneumatic, or electrical actuators associated with landing gear systems should not require adjustment or rigging once installed in the air vehicle. Spare units should be rigged at the time of manufacture or overhaul.
		LG-25	Mechanical shrink struts, when used, should not permit gear to jam in wheel well if failure of shrink mechanism occurs.

Guidelines by Category (Cont'd)

Category No.	Category Title	Guideline No.	Guideline
3.03	Structures	LG-26	Gravitational emergency extension of landing gear should be given preference over all other concepts.
		LG-30	Do not use landing gear wells to locate any type of auxiliary air inlet.
		LG-31	Landing gear doors designed to close after gear is extended should be capable of being manually opened on the ground without reliance on electrical or hydraulic power.
		LG-32	Design of landing gear doors normally closed after gear extension should ensure failure modes will not enable uncommanded opening on the ground.
		LG-33	Design of landing gear doors normally left open after gear extension should ensure no failure mode will enable closing on the ground.
		LG-34	Avoid sharp edges and corners on landing gear doors or fairings.
		LG-35	Avoid the use of landing gear doors to mount or house antennas, arrays, or air data sensors.
		LG-36	Location of integral wheel jack points on a strut should provide a minimum 6-1/2 inch clearance for positioning the jack with tire ruptured and wheel ground 2 inches off ground.
		LG-37	Integral hardpoints to jack the entire vehicle should ensure that identical jacks can be used at all jack points.
		LG-38	All landing gear doors should be interchangeable.
		LG-39	Gear-mounted tie-down or chain-down fittings should be interchangeable and easily replaceable.
		LG-41	No more than 1 jack should be required to change any singular wheel/tire assembly.
		LG-44	Landing gear door mechanisms and interfaces should ensure that multiple cycles or occasional exceedence of maximum gear-down speed do not result in loss of doors
		LO-01	Use LO compatible gap fillers for manufactured gaps in lieu of tape and butter (surface coating compound).
		LO-02	Avoid scheduled forced inspections or replacement of materials, coatings, or finishes solely to protect either the reliability or the signature.
		LO-03	Equipment and support structure requiring shrouds to reduce radar returns should not cause increases in equipment service/repair time.
		LO-04	Infrequently-accessed structural doors and panels incorporating special coatings or conductive paints should contain provisions for prying the door or panel clear of moldline with standard screwdriver without damage.
		LO-05	Do not locate flush mounted LO screens for auxiliary air inlets and exits in walkway areas unless durability has been proven.
		LO-06	Size flush mounted LO screens for auxiliary air inlets and exits to ensure functionality with up to 25 percent of the openings plugged.
		LO-07	Flush and non-flush LO screens should be interchangeable.
		MATL-01	A high degree of durability should be maintained for a minimum distance of 36 inches forward of the inflight refueling receptacle.
		MATL-02	Cosmetic type repairs should not exceed 1 hour including cure or drying times.
		MATL-03	Cosmetic and vehicle repair material shelf life should not be less than 24 months.
		MATL-04	Cosmetic and vehicle repair materials should be non-proprietary and non-single source.
		MATL-05	Cosmetic and vehicle repair materials should not require refrigeration or special facilities or atmospheres for storage.
		MATL-06	Repair criteria, repairs, and instructions should not be classified.
		MATL-07	All cosmetic touch-up and repair materials should be environmentally safe.
		MATL-08	Repairs (other than major depot repair) should not require autoclave type facilities.
		MATL-09	A high degree of durability should be achieved across all walkway areas on the top surfaces of all vehicles up to and including 95 percentile personnel.
		MATL-10	Coatings and finishes should be durable against the effects of missile gases, velocities, and particles emanating from the missile motor.
		MATL-11	Coatings and finishes should be durable against the effects of gun gases, projectile shock waves, and brass particles emanating from the projectile seal rings.

Guidelines by Category (Cont'd)

Category No.	Category Title	Guideline No.	Guideline
3.03	Structures		
		MATL-12	Leading edge materials and coatings should be durable against fragments from frangible gun port plugs.
		MATL-13	Special handling or shipping requirements of repair materials should be avoided.
		MATL-14	Leading edges, including chines, containing or constructed of radar absorbing materials, should be interchangeable to reduce vehicle downtime and simplify repairs.
		MATL-15	Doors and panels containing blade seals used for signature reduction should be interchangeable or contain interchangeable blade seals. Deviation is acceptable where repairs can be accomplished on the vehicle in a time equal to or less than door or seal remove and replace time.
		MC-02	Avoid the use of cotter pins, safety wire, safety clips, and similar devices to prevent maintenance-induced events leading to ground vehicle accidents or loss of air vehicles.
		MC-05	Avoid potential foreign object traps during manufacturing or operational maintenance by eliminating vertical penetrations of plumbing/fittings into tanks, compartments, or cells
		MC-07	Maximize areas of constant web thickness in firewalls, carry-through bulkheads, major frames, structural ribs, spars, webs, keels, and close-outs to provide flexibility in locating penetration fittings. Stepped chem milling, stepped machining, stepped composite layup concepts all tend to result in minimal available surface area for penetrations.
		MC-08	All in-line plumbing connections within a fuel tank or cell should be capable of making/breaking the interface by hand, require no torque, contain integral safety locking mechanisms, and should be void of any requirement for safety wire.
		MC-15	Route, orient, and position plumbing, wiring, ducts, and connectors sufficiently away from the outer surface of the vehicle to preclude induced damage due to minor dents, drill bits during repair, etc. Minimum rule of thumb is 1" away from the inner surface and 1" below a plate nut channel.
		MG-01	Mount LRUs/sub-systems on drawer slides or extender racks to provide easier accessibility during integration, testing, debug, and repair of Units Under Test (UUTs).
		OXY-05	Locate liquid oxygen (LOX) containers in a sealed, dedicated compartment to eliminate need for frequent visual inspections.
		OXY-07	Locate liquid oxygen containers to ensure simultaneous replacement with other turnaround activities.
		OXY-12	LOX compartments should be sealed from adjacent compartments and should contain dedicated overboard drains.
		P-01	Access door and panel fastener types for airborne vehicles should meet the following criteria: <ul style="list-style-type: none"> - use latches for a frequency of access of 0 to 40 flight hours - use High Strength Quick Release fasteners for a frequency of access of 40-400 flight hours - use structural screws for a frequency of access of 400 flight hours or more
		P-02	Access door and panel fastener types for surface vehicles should meet the following criteria: <ul style="list-style-type: none"> - use a spring loaded or latch fastener for an opening frequency of daily - use a one quarter turn fastener (or equivalent) for a opening frequency of weekly - use screws or bolts for all other cases
		P-03	All doors and panels subject to environmental elements should contain form-in-place seals (or equivalent) attached to the door structure, not substructure, to prevent damage during maintenance.
		P-04	Door and panel seals should be compatible with all types of on-board servicing fluids, de-ice and anti-ice fluids, and all fluids used for chemical, biological, and nuclear decontamination.
		P-05	Piano type hinges should not be used on doors or panels because they are subject to wear, corrosion, and sand and fluid entry.
		P-06	Access door and panel devices used to support door in opened position should meet the following criteria: <ul style="list-style-type: none"> - for airborne vehicles, design for 60 knot gust loads (or equivalent jet blast loads) - for ground vehicles, design for 50 mph gust loads
		P-07	Hinged access doors and panels capable of remaining in the opened position should not have sharp edges or corners.
		P-08	Removable access door and panel fasteners should be of identical grip length and diameter.
		P-09	Acceptable door and panel hold-open devices include over-center sheet metal spring, over-center spring link, spring cartridge, support strut, and pinned goose neck hinge.

Guidelines by Category (Cont'd)

Category No.	Category Title	Guideline No.	Guideline
3.03	Structures	P-10	Access doors and panels requiring non-captive fasteners should not be located forward of air inlet ducts or high-energy rotating components (e.g., prop fans, engine cooling fans, etc.).
		P-11	Access doors and panels should be interchangeable as justified by operation and support costs or life cycle costs.
		PERS-06	Storage bins, compartments, sacks, or bags should be available within the vehicle to store/protect all personal equipment required to conduct operations.
		PERS-07	All flight and ground vehicles should contain one cubic foot minimum storage compartment(s) for various loose and sundry personal items (for each individual).
		PERS-08	Design stowage and mounting provisions for portable air or oxygen containers to withstand 40G crash or impact loads.
		PYRO-07	Manual "safe/arm" mechanisms should be well-clear of inlet ducts, propellers, rotors, and similar rotating components.
		PYRO-08	Manual "safe/arm" mechanisms should be well-clear of engine exhausts, fuel/toxic vents, fluid drains, control surface deflection envelopes, and rescue path envelopes.
		PYRO-20	Weapon bay doors, when opened, should not block or restrict access to other servicing points.
		PYRO-26	Do not locate ammunition loader interfaces close to inlets, exhausts, fuel dumps and drains, antennas, sensors, lights, or hazardous protrusions.
		PYRO-27	Incorporate integral hoisting provisions at each weapon/store station to enable direct lift from the container or carrier to the attachment hardpoints.
		PYRO-29	Provide quick mechanical over-travel (no power) for weapon bay doors to maximize the weapon/store loading envelope.
		PYRO-30	Ensure weapon bay door arc (both normal and over-travel) does not block or intrude into adjacent service points or envelopes.
		PYRO-32	Provide sufficient longitudinal clearance between weapon bays to enable simultaneous loading of two bays.
		PYRO-33	Provide sufficient lateral clearance between weapon bays to enable simultaneous loading of two bays.
		PYRO-34	Weapon bay door seals should be bonded or attached to door structure to minimize induced seal damage during weapon or store loading.
		PYRO-35	Suspension system should permit any single weapon or store to be loaded by a two man crew.
		PYRO-36	Suspension system design and spacing should enable any combination of eight weapons to be loaded by two two-man crews within the refueling time of the vehicle (excludes nuclear weapons).
		PYRO-37	Internal weapon suspension arrangements should preclude sequential weapon loading.
		PYRO-39	Weapon bay ejectors and launchers should have the capability for total interchangeability and reconfigurability.
		PYRO-43	Launcher or ejector design/interface should not require a dual function of carrying airframe structural loads.
		PYRO-46	Design pylons, launchers, and ejector racks so that weapon loading, servicing, and reconfigurations can be accomplished using standard hand tools.
		PYRO-47	Installation design of ejectors, launchers, racks, and associated hardware interfaces should avoid reliance on torque wrenches.
		R-01	Large radomes wherein the combination of the diameter and length exceeds 60" should be top-hinged. Hinge should be load-carrying to reduce radome retention fastener count.
		R-02	Radome and radar array support structure design and material selection should eliminate the need for LO type fillers or shrouds.
		SABCH-01	Do not locate auxiliary air inlets, sensors, access doors, or drains in boundary bleed areas.
		SABCH-02	All flush type structural screws should have identical head drives for the entire vehicle.
		SABCH-03	All non-flush type structural screws should have identical head drive recesses for the entire vehicle.
		SABCH-04	Special high strength bolts, such as twelve-point heads, should be fully justified from standpoint of the cost of ownership and effectiveness.
		SABCH-05	Structural design should avoid the reliance on blind fasteners unless fully supported by cost, weight, schedule, and effectiveness analysis.
		SABCH-06	Structural design should avoid the potential of dissimilar material or fastener corrosion.
		SABCH-07	No structural fasteners should be used that require special tools for installation.

Guidelines by Category (Cont'd)

Category No.	Category Title	Guideline No.	Guideline
3.03	Structures	SABCH-08	Taper pins should be threaded and retained with self-locking hardware.
		SABCH-09	Pins and collars (lockbolts) should only be used in applications which do not normally require removal.
		SABCH-10	Do not use lockbolts in composites.
		SABCH-11	In rare instances where the use of dissimilar material in immediate contact cannot be avoided, they should be sufficiently insulated to endure for the life of the vehicle.
		SABCH-12	Avoid tapping threads into structural members. Use of heli-coil type or similar insert concepts is permissible.
		SABCH-13	No structural design concept should rely on frequent scheduled inspections to monitor or otherwise ensure structural integrity.
		SABCH-14	No structural fastener intended to carry shear or tension loads should be smaller than 1/4" diameter (.25").
		SABCH-15	Give preference to butt type splices over lap type splices in the design of manufacturing splices.
		SABCH-16	Wing-to-fuselage attachment should give preference to tension ties over shear ties to improve overall volumetric efficiency.
		SABCH-17	Hardpoints for securing tie down chains, cables, and devices during transport should not require reaching under or crawling under the vehicle.
		SABCH-18	Rings, posts, and clevis devices used for attaching tie downs should not require opening of doors or panels for access.
		SABCH-19	Avoid tie down concepts requiring attaching hardpoints as a prerequisite.
		SABCH-20	Location of hardpoints used for tie down attachment should: - Remain outside of door and panel opening envelopes. - Be clear of exhaust pipes, ducts, manifolds, and mufflers. - Be clear of overboard fluid drains and vents.
		SABCH-21	Tire pressure reduction should not be required prior to tie down solely to increase the tire footprint
		SAFE-01	Drag chute installation designs not containing electrical safing should contain remote safe/arm provisions reachable from ground level by 5 percentile females. Remove location should be clear of engine exhaust areas and flight control deflection envelopes.
		SAFE-02	Emergency ingress actuation provisions into cockpits, crew stations, passenger compartments, and operator stations should be accessible from the ground by 5 percentile females.
		SAFE-05	Crash locator beacon door opening/ejection mechanisms should contain integral electrical safe/arm features.
		SAFE-06	Wing fold locking mechanisms should provide a moldline indication that locks are in place. Loose or separate safety devices that must be installed manually should be avoided.
		SAFE-08	A single lever safety should, when positioned, safe the entire escape/ejection system. Use of the single lever to "arm" should require two hands.
		SAFE-09	Safing the canopy jettison system should be accomplished through the same lever device used to safe the ejection seat.
		SAFE-12	Internal weapon bay doors should contain integral safety locking features for use during maintenance and weapon loading and downloading.
		SAFE-13	It should not be possible to unsafe a weapon bay door integral lock when a door closed signal is present.
		SE-07	The design construction concept and material selection for support equipment structure should not rely or depend upon the use of scheduled maintenance, NDI, or NDT to protect the durability or integrity of the equipment in the operational environment.
		SEAT-04	Design ejection seats so they can be replaced with canopy or escape hatch installed.
		SEAT-05	Design ejection seat pyrotechnic devices so they are 100 percent viewable and accessible with seat installed.
		SEAT-06	Do not use seat removal as a means of access.
		SIMP-01	Location and design of all exterior lights should not require protective covers in ground environments.
		SIMP-02	Landing and taxi lights should be mounted on landing gear struts or doors to eliminate separate compartments, doors, and retraction/extension mechanisms.
		SIMP-03	Speed brake or speed brake cavity should contain integral mechanical locking mechanism for personnel safety.
		SKID-06	Use non-skid finishes on the upper surfaces of skids and floats for use as steps and walkways.

Guidelines by Category (Cont'd)

Category No.	Category Title	Guideline No.	Guideline
3.03	Structures		
		SKID-07	Design floats with simple drain provisions for each compartment.
		SURV-01	Design containers used for dinghy stowage to be structurally capable of containing the dinghy within the event of unintentional or uncommanded inflation.
		SURV-02	Provide crew stations, crew compartments, and operator areas containing dinghies as emergency equipment with a suitable tool for puncturing or cutting the dinghy in the event of inadvertent inflation. Locate the tool so that access is assured during dinghy inflation.
		T-01	Do not locate pyro, gas, and air (PGA) control system exhaust exits: <ul style="list-style-type: none"> - In proximity to safe, arm, or servicing areas, - Adjacent to auxiliary inlets, - In close proximity to crew boarding areas, weapons, emergency ingress/egress areas, and optics or optical glass. Design pyro type thruster exits associated with emergency use or backup with simple exit closure devices to identify if a thruster has been fired.
		T-02	
		T-03	Provide protective screens for PGA exits that normally remain open to prevent intrusions from fowl or wildlife.
		T-04	Provide protective closure provisions for PGA exits located or oriented to exposure from the elements.
		W-01	Hat section type structural stiffeners with sufficient cross sectional area should be considered as a routing tunnel for wiring and coax.
		WBAY-01	Equipment bays and compartments should not require installation of special cavity fillers when equipment is not installed.
		WBAY-02	Pylon-to-wing electrical or plumbing interfaces should have automatic close-out covers when pylon is jettisoned or not installed.
		WBAY-04	The gap treatment should be a permanent installation on the pylon, wing, or both, not a separate seal.
		WBAY-06	Pylon rigging should not be required for gap seal control.
		WBAY-07	Gap seal should not degrade interchangeability of pylon.
		WBAY-16	Gap seals should not degrade loading while wearing arctic or chemical, biological, or radiation protective clothing.
		WBAY-17	Special coatings or conductive paints on pylons, launchers, racks, launchers, tanks, pods, etc. should have the durability to withstand contact with support stands/cradles during storage.
		WBAY-18	The proximity of the gun firing barrel to structure should be such that structural furrows or channels are not required for projectile clearances during firing.
		WBAY-19	Frangible gun ports should take preference over mechanized gun port doors.
		WBAY-20	Gun plugs required solely to maintain a given signature level should be capable of on-board stowage for use only when a threat requires their presence.
		WBAY-21	Coatings and finishes in the area of gun barrels should be durable to withstand the effect of exiting projectile shockwaves.
		WBAY-22	The proximity of the gun blast deflector to structure should not require reliance on high-temperature paints or coatings to protect the structure.
		WIND-02	Optic windows should be located for ease of inspection, cleaning, and induced damage potential from personnel or support equipment.
		WIND-06	Do not locate windows in the proximity of rooster tails created by wheels/tires passing through water or slush.
		WIND-12	Design EO windows and optics to be interchangeable among the same air vehicle types or same ground vehicle types.
3.03.01	Radomes	A-10	Provide a sufficient number of compartment fluid drains to ensure fluid drainage for varying aircraft static attitudes and varying terrain slopes for ground vehicles.
		A-11	Locate compartment electrical penetrations close to the access opening for ease of sight, probing, repair, and to eliminate fluid soaking, wicking, or contamination.
		A-12	Locate compartment electrical penetrations far enough from the access opening to prevent damage resulting from improper (over-length) panel fasteners.
		A-17	All structural fasteners in an access door or panel should be of identical grip and diameter. In rare cases where this is not possible, fasteners of different grip must have different diameters to prevent a shorter fastener being substituted for the correct, longer fastener.

Guidelines by Category (Cont'd)

Category No.	Category Title	Guideline No.	Guideline
3.03.01	Radomes	A-18	Use transparent windows, quick-opening covers, or openings without any cover to permit quick visual inspections where needed.
		BIT-01	During design of the BIT, use worst-case stress analysis to ensure that any circuit failures induced by temperature extremes, tolerance build-up, power supply variations, and combinations thereof are identified.
		BIT-02	Ensure that BIT system thresholds are consistent with those across the system, subsystem, item, module, and piece-part levels to prevent excessive numbers of Cannot Duplicate (CND) and Retest OK (RTOK) events from occurring.
		BIT-03	The degree of BIT required or proposed should be based on the respective failure rates and the appropriate FMECA at all equipment indenture levels.
		BIT-04	Limit the amount of data that is recorded to a manageable size by: <ul style="list-style-type: none"> - Limiting the number of signals that are monitored - Limiting the maximum sampling rate - Reducing the time span over which data is accumulated - Restricting the type of data accumulated
		BIT/BITE-02	Design EMI protection to eliminate finger type EMI contact devices.
		D&V-01	The geometric aspects of structural design and interfaces should not result in any natural bathtubs.
		D&V-02	Closed structural sections subject to condensation or fluid migration should contain drainage provisions.
		D&V-03	Crew cabs, operators' compartments, crew stations, cockpits, and passenger compartments should be subject to the same corrosion prevention measures as the exteriors of the vehicles. Low points, pockets, and related fluid collection points within should be provided with low point drains.
		EDECOM-01	Provide surface sensors on equipment located in compartments containing louvers, screens, flush inlets, or similar openings to the environment to indicate the presence of chem/bio contaminants.
		EDECOM-02	Provide integral sensors (viewable from the exterior) for equipment subject to internal forced-air cooling from outside or external air to indicate the presence of contaminants.
		EDECOM-03	Design equipment surfaces and structure to be compatible with all decontamination agents and methods.
		EDECOM-04	Provide passive overboard drains in compartments subject to decontamination processes to void the area of contaminants.
		EDECOM-05	Provide hoist, lift or transport handles for equipment requiring removal from the host vehicle for decontamination. In instances where this may not be practical, design the equipment with hardpoints for attaching parasitic carrying provisions
		ENV-01	Materials, treatments, coatings, finishes should be compatible with all anti-ice and de-ice fluids, chemical and biological decontamination fluids, washing and cleaning fluids, and all vehicle subsystem fluids.
		ENV-02	There should be no top coat or treatment deterioration throughout the standard temperature and humidity spectrum.
		ENV-03	For airborne vehicles, the finishes should be durable against rain, hail, and dynamic erosion throughout the flight envelope.
		ENV-04	For airborne and ground vehicles, the finishes should be durable against sand erosion throughout all surface wind speeds experienced in arid or desert geographical locations.
		EXTING-06	Provide an alternate capability to activate the system remotely from the cockpit/crew station, or operator's position to satisfy emergency situations during vehicle maintenance.
		EXTING-07	Analyze the vehicle operational environment and type of fire zones to determine if remote stop/shut-off of equipment is warranted.
		EXTING-08	Analyze the vehicle operational environment and type of fire zones to determine if remote alarm and/or visual indication of a fire is warranted.
		EXTING-09	Do not locate provisions for overboard venting or dumping of extinguishing agents in areas that could create hazards for personnel.
		F-01	Use blind fasteners only where absolutely necessary or where considerable cost can be saved.
		F-02	Minimize access fasteners while making them quick release, easily removed and replaced, and captive.
		LO-01	Use LO compatible gap fillers for manufactured gaps in lieu of tape and butter (surface coating compound).

MIL-HDBK-470A

APPENDIX C

Guidelines by Category (Cont'd)

Category No.	Category Title	Guideline No.	Guideline
3.03.01	Radomes	LO-02	Avoid scheduled forced inspections or replacement of materials, coatings, or finishes solely to protect either the reliability or the signature.
		LO-03	Equipment and support structure requiring shrouds to reduce radar returns should not cause increases in equipment service/repair time.
		LO-04	Infrequently-accessed structural doors and panels incorporating special coatings or conductive paints should contain provisions for prying the door or panel clear of moldline with standard screwdriver without damage.
		LO-06	Size flush mounted LO screens for auxiliary air inlets and exits to ensure functionality with up to 25 percent of the openings plugged.
		LO-07	Flush and non-flush LO screens should be interchangeable.
		MATL-02	Cosmetic type repairs should not exceed 1 hour including cure or drying times.
		MATL-03	Cosmetic and vehicle repair material shelf life should not be less than 24 months.
		MATL-04	Cosmetic and vehicle repair materials should be non-proprietary and non-single source.
		MATL-05	Cosmetic and vehicle repair materials should not require refrigeration or special facilities or atmospheres for storage.
		MATL-06	Repair criteria, repairs, and instructions should not be classified.
MATL-07	All cosmetic touch-up and repair materials should be environmentally safe.		
MATL-08	Repairs (other than major depot repair) should not require autoclave type facilities.		
MATL-09	A high degree of durability should be achieved across all walkway areas on the top surfaces of all vehicles up to and including 95 percentile personnel.		
MATL-10	Coatings and finishes should be durable against the effects of missile gases, velocities, and particles emanating from the missile motor.		
R-01	Large radomes wherein the combination of the diameter and length exceeds 60" should be top-hinged. Hinge should be load-carrying to reduce radome retention fastener count.		
R-02	Radome and radar array support structure design and material selection should eliminate the need for LO type fillers or shrouds.		
TP-01	Locate Input/Output (I/O) test points and associated readouts in close proximity to each other so that one person can perform testing.		
TP-02	Protect test points against the environment and from induced contamination.		
TP-03	Protect test points from outside signal generation.		
WBAY-01	Equipment bays and compartments should not require installation of special cavity fillers when equipment is not installed.		
A-08	Plumbing penetrations into a compartment should not be on a vertical axis due to difficulty in making or breaking vertically-oriented connections. When compartment access is from the bottom, vertically-oriented connections can allow fluid to leak onto the maintainer. When access is from the top, such connections can allow foreign matter to enter the line. Use horizontal penetrations whenever possible.		
A-10	Provide a sufficient number of compartment fluid drains to ensure fluid drainage for varying aircraft static attitudes and varying terrain slopes for ground vehicles.		
A-17	All structural fasteners in an access door or panel should be of identical grip and diameter. In rare cases where this is not possible, fasteners of different grip must have different diameters to prevent a shorter fastener being substituted for the correct, longer fastener.		
C-01	Avoid swivel type connectors and fittings for air, fuel, or hydraulic line interfaces due to their history of low reliability.		
C-02	Provide spacing between parallel plumbing runs so that in-line couplings can be replaced without removing lines or disconnecting any line support devices.		
D&V-01	The geometric aspects of structural design and interfaces should not result in any natural bathtubs.		
D&V-02	Closed structural sections subject to condensation or fluid migration should contain drainage provisions.		
D&V-03	Crew cabs, operators' compartments, crew stations, cockpits, and passenger compartments should be subject to the same corrosion prevention measures as the exteriors of the vehicles. Low points, pockets, and related fluid collection points within should be provided with low point drains.		
3.03.02	Drains and Vents		

Guidelines by Category (Cont'd)

Category No.	Category Title	Guideline No.	Guideline
3.03.02	Drains and Vents		
		EDECOM-04	Provide passive overboard drains in compartments subject to decontamination processes to void the area of contaminants.
		ENG-06	All other engine surfaces and engine-mounted accessory surfaces should be free of pockets, channels, and bathtubs that could trap and retain fluids.
		ENG-48	Do not drain or dump residual fuel in the engine fuel control/manifold overboard. When it is not possible to follow this guideline, route the fuel to an engine-mounted collector tank capable of retaining fuel from two shutdowns.
		ENV-01	Materials, treatments, coatings, finishes should be compatible with all anti-ice and de-ice fluids, chemical and biological decontamination fluids, washing and cleaning fluids, and all vehicle subsystem fluids.
		ENV-02	There should be no top coat or treatment deterioration throughout the standard temperature and humidity spectrum.
		FUEL-01	Locate fuel vent and dump masts to ensure exiting fuel will be clear of servicing, loading, arming and safing areas for all types of ground and airborne vehicles.
		LO-06	Size flush mounted LO screens for auxiliary air inlets and exits to ensure functionality with up to 25 percent of the openings plugged.
		LO-07	Flush and non-flush LO screens should be interchangeable.
		MC-01	All clamps should contain torque-set or torque-limiting connections to prevent clamp or component failure due to over-torque. Clamp installation call outs should not depend on special tools to establish the required torque values.
		MC-02	Avoid the use of cotter pins, safety wire, safety clips, and similar devices to prevent maintenance-induced events leading to ground vehicle accidents or loss of air vehicles.
		MC-03	All tubing connections and interfaces should use rosan/dynatube (or equivalent) to (1) enable connect or disconnect with one hand, one tool, (2) eliminate the need to safety the connection, (3) provide a superior seal, and (4) negate need to reposition line(s) during component replacement.
		MC-04	No trombone type, flared tube type, or piloted line type interfaces should be used to avoid the need for removal or repositioning during equipment removal.
		MC-05	Avoid potential foreign object traps during manufacturing or operational maintenance by eliminating vertical penetrations of plumbing/fittings into tanks, compartments, or cells
		MC-06	Locate, position, orient all plumbing and duct electrical connectors to prevent the need for sequential installation or removal.
		MC-07	Maximize areas of constant web thickness in firewalls, carry-through bulkheads, major frames, structural ribs, spars, webs, keels, and close-outs to provide flexibility in locating penetration fittings. Stepped chem milling, stepped machining, stepped composite layup concepts all tend to result in minimal available surface area for penetrations.
		MC-08	All in-line plumbing connections within a fuel tank or cell should be capable of making/breaking the interface by hand, require no torque, contain integral safety locking mechanisms, and should be void of any requirement for safety wire.
		MC-09	All plumbing connections and fittings used for fuel systems should contain integral bonding features to eliminate the need for bonding clamps or jumper cables.
		MC-10	In rare instances where a plumbing run contains complex form or geometry that would require removal of other plumbing or equipment for access, in-line connectors should be incorporated to maintain the integrity of other plumbing or equipment.
		MC-11	No subsystem plumbing, equipment, or wiring should use a tank, cell, or compartment containing liquids as a means for routing or penetration simplicity during manufacture.
		MC-12	All plumbing and connectors containing liquids should be meniscus-free.
		MC-13	In instances where plumbing or connector interfaces cannot or are not keyed for a specific orientation, all identification, markings, cautions, and directions should be placed 360 degrees around the tube or duct.
		MC-14	Where multiple connectors are located in close proximity, ensure (1) a minimum hand tool arc of 120 degrees can be maintained, and (2) stagger fittings to ensure firm coupling interface/hand tool interface can be accomplished without inducing damage to adjacent lines.
		OXY-12	LOX compartments should be sealed from adjacent compartments and should contain dedicated overboard drains.
		PYRO-26	Do not locate ammunition loader interfaces close to inlets, exhausts, fuel dumps and drains, antennas, sensors, lights, or hazardous protrusions.

Guidelines by Category (Cont'd)

Category No.	Category Title	Guideline No.	Guideline
3.03.03	Crew Stations, Crew Cabs, Cockpits, and Personnel Enclosures	A-01	Seal equipment bays and compartments against the environmental elements including all types of servicing fluids used for the vehicle, all types of anti-ice and de-ice fluids, and all types of fluids used for chemical, biological, or nuclear decontamination
		A-04	Use stiffening beads in lieu of flanges to the maximum extent to enhance compartment volume and simplify repairs. Stiffening beads should have the convex surface toward the compartment to eliminate fluid traps.
		A-05	Keep all machined compartment frames, webs, and closure panels to a constant thickness (e.g., not stepped or tapered) to ease simplicity of fluid or electrical penetrations and ease and simplicity of structural repair.
		A-06	Hardpoints (structural attachment and load bearing areas) within a compartment to assist in equipment mounting or support should not be integral with the machined part. Hardpoints should be parasitic to enable quick repair in case of wear or damage in lieu of precise ream/bush repair typical of machined hardpoints.
		A-07	Paint equipment bay and compartment interiors a high gloss white to maximize lighting reflectivity, visibility, and rapid leak detection capability.
		A-08	Plumbing penetrations into a compartment should not be on a vertical axis due to difficulty in making or breaking vertically-oriented connections. When compartment access is from the bottom, vertically-oriented connections can allow fluid to leak onto the maintainer. When access is from the top, such connections can allow foreign matter to enter the line. Use horizontal penetrations whenever possible.
		A-09	Any heat or temperature sensitive structure within a compartment should contain heat-sensitive tape or appropriate heat sensor for easy indication of over-temperature excursions.
		A-10	Provide a sufficient number of compartment fluid drains to ensure fluid drainage for varying aircraft static attitudes and varying terrain slopes for ground vehicles.
		A-11	Locate compartment electrical penetrations close to the access opening for ease of sight, probing, repair, and to eliminate fluid soaking, wicking, or contamination.
		A-12	Locate compartment electrical penetrations far enough from the access opening to prevent damage resulting from improper (over-length) panel fasteners.
		A-13	Two-sided or two-surfaced access should not be required for access to equipment interfaces and hardpoints. The term two-sided infers top/bottom, left/right, front/back, or combinations thereof.
		A-14	Do not locate nutplates or gang channels in inaccessible areas that would require extensive disassembly or equipment removal to gain access.
		A-18	Use transparent windows, quick-opening covers, or openings without any cover to permit quick visual inspections where needed.
		BIT-01	During design of the BIT, use worst-case stress analysis to ensure that any circuit failures induced by temperature extremes, tolerance build-up, power supply variations, and combinations thereof are identified.
		BIT-02	Ensure that BIT system thresholds are consistent with those across the system, subsystem, item, module, and piece-part levels to prevent excessive numbers of Cannot Duplicate (CND) and Retest OK (RTOK) events from occurring.
		BIT-03	The degree of BIT required or proposed should be based on the respective failure rates and the appropriate FMECA at all equipment indeture levels.
		BIT-04	Limit the amount of data that is recorded to a manageable size by: <ul style="list-style-type: none"> - Limiting the number of signals that are monitored - Limiting the maximum sampling rate - Reducing the time span over which data is accumulated - Restricting the type of data accumulated
		BIT-05	Incorporate testability design features as an integral part of equipment preliminary design process.
		BIT-06	Mission critical functions should be monitored by BIT.
		BIT-09	Use concurrent BIT to monitor system critical functions.
		BIT-26	Locate routinely used test points so they are accessible without removing or disassembling other equipment
		BIT-27	Periodic and initiated BIT should detect at least 98% of all failures and isolate a minimum 99% of those failures detected to a single LRU or WRA.

Guidelines by Category (Cont'd)

Category No.	Category Title	Guideline No.	Guideline
3.03.03	Crew Stations, Crew Cabs, Cockpits, and Personnel Enclosures		Design BIT to have the same level of EMI protection as the system or equipment being monitored.
		BIT/BITE-02	Design EMI protection to eliminate finger type EMI contact devices.
		C-01	Avoid swivel type connectors and fittings for air, fuel, or hydraulic line interfaces due to their history of low reliability.
		C-02	Provide spacing between parallel plumbing runs so that in-line couplings can be replaced without removing lines or disconnecting any line support devices.
		CARGO-01	Ground vehicles with storage bays or compartments accessible from outside the vehicle should: <ul style="list-style-type: none"> - Have the door sill located no lower than knee height to accommodate a wide range of percentiles while standing. - Ensure door handles are flush with outer surface to protect personnel. - Contain goose neck hinges to protect the hinge from the elements. - Contain peripheral door seals that will protect against blowing sand entry at 50 mph. - Ensure door can be opened with transport tie downs installed. - Ensure door opening envelope does not intrude into the opening envelope of an adjacent door. - Contain simple sheet metal hold-open spring or mechanism. - Ensure floor of bay or compartment is flush with sill to simplify cleanout and drainage. - Ensure door unlocking and opening mechanism can be actuated by a 95 percentile male hand while wearing arctic gloves. - Contain 15 percent added volume for density growth.
		CARGO-02	Ground vehicles with small exterior storage bays or compartments containing emergency equipment or supplies should: <ul style="list-style-type: none"> - Be located at chest height of the 50 percentile male. - Contain unlatching mechanisms activated by pushing inward on the door. - Meet all other generic bay and compartment requirements.
		CBR-02	Ensure vehicle overboard passive liquid drains are clearly marked or visible to enable personnel to remain clear of area.
		CBR-04	Design emergency ingress provisions so they can be activated by a 95 percentile male wearing full protective chemical or biological protection gear.
		CBR-05	Size rescue doors, panels, and "cut here" areas to accommodate the 95 percentile shoulder width wearing full protective chemical or biological protection gear.
		CBR-06	Consider the reduction in peripheral vision resulting from wearing chemical or biological protection gear when designing intended fire paths and crash rescue paths into a vehicle.
		CONT-01	Control rods should use Boyd or impedance type bolts (or equivalent) to eliminate the need for cotter pins or safety wire.
		CONT-02	Do not use metal control cables for vehicles that will operate in salt water or salt air environments.
		CONT-03	Use control rods rather than control cables for non-complex applications and non-complex routing within the vehicle.
		CONT-04	Use control cables rather than control rods for most complex applications.
		CONT-05	Route cables so that 100 percent of a cable will be viewable for inspection.
		CONT-06	Design all pulleys and brackets associated with cable installations so they are accessible by a 75 percentile male hand.
		CREW-01	Canopy attachment/hinge hardpoints should be located on the same structural subassembly as the canopy locking hardpoints.
		CREW-02	Armor protection integrated with the vehicle structure should be given preference over parasitic armor.
		CREW-03	In rare cases where armor is parasitic, armor should be interchangeable and easily installed.
		CREW-04	Avoid wiring, coax, and plumbing penetrations through the floor of crew cabs, operators' compartments, crew stations, cockpits, and passenger compartments.
		CREW-05	Structural instrument panels, dashboards, and control panels should be modularized for easy and adequate access to all interfaces, to simplify manufacturing, and to reduce maintenance-induced problems.
		CREW-06	Film magazines, tapes, and removable modules should permit considerable handling without reliance on special support equipment protection.
		CREW-07	Electronic and photosensitive storage media should withstand the adverse environment created by ground, flightline, or shipboard electromagnetic fields and light sources.

MIL-HDBK-470A

APPENDIX C

Guidelines by Category (Cont'd)

Category No.	Category Title	Guideline No.	Guideline
3.03.03	Crew Stations, Crew Cabs, Cockpits, and Personnel Enclosures	CREW-08	Data storage media containers and modules should be capable of chemical and biological decontamination processes.
		CREW-09	Crew and operator station cassettes or magazines should be capable of being removed and installed with one hand while the operator or air crew is seated and strapped in.
		CREW-10	Design cameras, recorders, and sensors to be fully interchangeable and quickly replaceable.
		CREW-11	Design cameras, lenses, reconnaissance pods, aiming devices, and related equipment so they can be reconfigured by one individual.
		CREW-12	Requirements for boresighting should not be part of the design or integration.
		CREW-13	Provide storage provisions in each vehicle type (ground and airborne) to store extra tapes, modules, camisters, cassettes, as appropriate to the intended vehicle use/mission.
		D&V-01	The geometric aspects of structural design and interfaces should not result in any natural bathtubs.
		D&V-02	Closed structural sections subject to condensation or fluid migration should contain drainage provisions.
		D&V-03	Crew cabs, operators' compartments, crew stations, cockpits, and passenger compartments should be subject to the same corrosion prevention measures as the exteriors of the vehicles. Low points, pockets, and related fluid collection points within should be provided with low point drains.
		EC-01	A threaded electrical connector should contain integral locking mechanisms and visual indications that the connector is properly seated and locked.
		EC-02	An electrical connector requiring less than one full turn to connect or disconnect should contain integral locking mechanisms and visual indications that the connector is properly seated and locked.
		EC-03	A push-pull electrical connector (excluding rack-and-panel type) should contain integral locking features and visual indication that the connector is properly seated and locked.
		EC-04	All electrical connectors should be keyed or asymmetrically shaped to ensure proper alignment.
		EC-05	All electrical connectors should contain scoop-proof shells to ensure pin damage will not occur prior to engaging key way.
		EC-06	All electrical connectors should be corrosion resistant to reduce or eliminate the need for scheduled inspections or corrosion prevention measures.
		EC-07	Avoid using electrical connectors requiring any type or form of soldering.
		EC-08	Locate and position electrical connectors such that all pin identification for either half can be easily seen.
		EC-09	Electrical connectors selected for critical applications on ground vehicles should be both accessible and capable of being connected/disconnected by a fifty percentile gloved male hand.
		EC-10	Separation between grouped electrical connectors should be sufficient to ensure make or break of any connector by a fifty percentile gloved male hand. Where this is not possible, an alternate method should be used such as the use of standard-offs, long-shelled connectors alternated with standard connectors, 180-degree connectors alternated with 90-degree connectors, or innovative equivalents.
		ECS-01	Design so that equipment servicing status are accessible and readable from the ground level for air vehicles and from the operator's position for ground and water vehicles.
		ECS-02	Do not locate equipment servicing points in crew, passenger, or operator areas.
		ECS-03	Heat exchangers using hot liquids as the heat source should not be located inside the compartments used for operator, crew, or passengers.
		ECS-04	Plumbing, lines, or hoses containing hot liquids, toxic gases or liquids should be external to operator, crew, or passenger stations.
		ECS-11	Design air inlets, outlets, and exhausts to be accessible without reliance on ladders or work stands for ease of installing protective plugs or covers.
		ECS-12	Design air inlets, outlets, and exhausts with screens to prevent bird or rodent entry.
		ECS-13	Design air inlets, outlets, and exhausts to be meniscus-free to prevent a bathtub effect. In remote instances where this is not possible, passive drains should be provided at all low points to prevent liquid accumulation with the vehicle in its normal static attitude.

Guidelines by Category (Cont'd)

Category No.	Category Title	Guideline No.	Guideline
3.03.03	Crew Stations, Crew Cabs, Cockpits, and Personnel Enclosures		Instances where air inlets, outlets, and exhausts are subject to water entry, passive drains should be employed capable of handling 4" of rain per hour.
		ECS-15	Locate and orient air inlets, outlets, and exhausts in a manner that prevents their use as footholds during maintenance.
		ECS-16	All components contained in the systems, including all attaching brackets and supports, should use hex-head self-locking bolts for ease and simplicity of installation.
		ECS-17	Do not use air ejectors due to their low reliability and susceptibility to clogging.
		ECS-18	Avoid the use of insulation blankets containing polyvinyl for any application due to the dense smoke and toxic fumes if burned or subjected to high temperature bleed air leakage.
		ECS-19	Thermal blankets and covers used in ground vehicles should be replaceable.
		ECS-20	Minor rips, tears, and punctures in ground vehicle thermal blankets and covers should be capable of being repaired in place.
		ECS-21	Do not locate ground cooling or circulation fans that operate at high noise levels in operator, crew, or passenger compartments.
		ECS-27	Use temperature-limiting devices with high temperature air systems to ensure no single or combination of surface wind, cross wind, ground operation or flight operation will damage windshields, canopies, windows or optics.
		ENG-11	Control-by-wire or control-by-light throttling concepts should take precedence over mechanical controls.
		ENV-01	Materials, treatments, coatings, finishes should be compatible with all anti-ice and de-ice fluids, chemical and biological decontamination fluids, washing and cleaning fluids, and all vehicle subsystem fluids.
		ENV-02	There should be no top coat or treatment deterioration throughout the standard temperature and humidity spectrum.
		ENV-03	For airborne vehicles, the finishes should be durable against rain, hail, and dynamic erosion throughout the flight envelope.
		ENV-04	For airborne and ground vehicles, the finishes should be durable against sand erosion throughout all surface wind speeds experienced in arid or desert geographical locations.
		ENV-06	For ground vehicles, the finishes should be compatible with and durable against all rain, hail, sleet, snow, and ice conditions experienced in all intended operational environments.
		EXT-01	Locate Tanks, Pods, Containers, and Devices (TPCD's) so they do not block or restrict access to existing vehicle access areas or access approach envelopes.
		EXT-02	Design TPCD's for fuel containment to automatically interface to the host vehicle during installation or removal.
		EXT-03	Design TPCD's to be fully compatible with the existing vehicle built-in hoisting provisions and locking devices.
		EXT-05	Design access doors for cargo type TPCD's to be non-load carrying and with simple latches for all doors and panels.
		EXT-06	Design cargo TPCD's to ensure all cargo and equipment can be downloaded and uploaded with the TPCD installed on the host vehicle.
		EXTING-06	Provide an alternate capability to activate the system remotely from the cockpit/crew station, or operator's position to satisfy emergency situations during vehicle maintenance.
		EXTING-07	Analyze the vehicle operational environment and type of fire zones to determine if remote stop/shut-off of equipment is warranted.
		EXTING-08	Analyze the vehicle operational environment and type of fire zones to determine if remote alarm and/or visual indication of a fire is warranted.
		EXTING-09	Do not locate provisions for overboard venting or dumping of extinguishing agents in areas that could create hazards for personnel.
		FI-06	In an airborne avionics system, consider indicating mission critical faults on a pilots "head-up" display accompanied with an audible alarm, so that the pilot can easily check for critical system or mission threatening problems.
		FI-07	Ensure that system user manuals include instructions for faults not covered by BIT such as, system will not power up or system is being used in an incorrect environment such as, at the wrong altitude, etc.
		FI-08	Interlock the high power sections of systems and subsystems with visual/audible BIT to ensure safe system activation.
		FI-09	Design BIT to first conduct self-test for circuitry integrity before conducting system test.

MIL-HDBK-470A

APPENDIX C

Guidelines by Category (Cont'd)

Category No.	Category Title	Guideline No.	Guideline
3.03.03	Crew Stations, Crew Cabs, Cockpits, and Personnel Enclosures	FI-10	Use clear text to report failures rather than alpha-numeric codes, lights, indicators, etc.
		FI-11	Locate BIT circuitry on the same level of the subsystem under test to simplify test and repair when it is removed from the main system.
		FUEL-01	Locate fuel vent and dump masts to ensure exiting fuel will be clear of servicing, loading, arming and safing areas for all types of ground and airborne vehicles.
		FUEL-02	Manufacturing splices for major sub-assemblies should not intrude into or through integral fuel cells or tanks.
		FUEL-03	Structural bolts, screws, and fasteners should not penetrate into integral fuel cells or tanks other than those used for access door attachment.
		IN(V)-05	Locate the inlet duct edge a minimum of 60 inches from the cockpit or crew station to eliminate restricting engine operation to canopy-closed conditions.
		LG-02	Hardpoints for attachment of landing gear trunnions should be capable of carrying all induced gear loads for the life of the airframe.
		LG-03	Hardpoints for attachment for landing gear trunnions should not be machined as an integral part of the airframe structure when normal design sink rates over 25 feet per second are required.
		LG-04	Do not use Beryllium and Beryllium base alloys in any location subject to wear or corrosive atmospheres or in installations where machining may be required.
		LG-19	When deemed necessary for the respective design, pilots, flight crews, or operators should have an indication of the downlock status in the cockpit or crew station to avoid the necessity of a flight abort.
		LO-01	Use LO compatible gap fillers for manufactured gaps in lieu of tape and butter (surface coating compound).
		LO-02	Avoid scheduled forced inspections or replacement of materials, coatings, or finishes solely to protect either the reliability or the signature.
		LO-03	Equipment and support structure requiring shrouds to reduce radar returns should not cause increases in equipment service/repair time.
		LO-04	Infrequently-accessed structural doors and panels incorporating special coatings or conductive paints should contain provisions for prying the door or panel clear of moldline with standard screwdriver without damage.
		LO-05	Do not locate flush mounted LO screens for auxiliary air inlets and exits in walkway areas unless durability has been proven.
		LO-06	Size flush mounted LO screens for auxiliary air inlets and exits to ensure functionality with up to 25 percent of the openings plugged.
		LO-07	Flush and non-flush LO screens should be interchangeable.
		MATL-02	Cosmetic type repairs should not exceed 1 hour including cure or drying times.
		MATL-03	Cosmetic and vehicle repair material shelf life should not be less than 24 months.
		MATL-04	Cosmetic and vehicle repair materials should be non-proprietary and non-single source.
		MATL-05	Cosmetic and vehicle repair materials should not require refrigeration or special facilities or atmospheres for storage.
		MATL-06	Repair criteria, repairs, and instructions should not be classified.
		MATL-07	All cosmetic touch-up and repair materials should be environmentally safe.
		MATL-08	Repairs (other than major depot repair) should not require autoclave type facilities.
		MATL-09	A high degree of durability should be achieved across all walkway areas on the top surfaces of all vehicles up to and including 95 percentile personnel.
		MATL-10	Coatings and finishes should be durable against the effects of missile gases, velocities, and particles emanating from the missile motor.
		MATL-11	Coatings and finishes should be durable against the effects of gun gases, projectile shock waves, and brass particles emanating from the projectile seal rings.
		MATL-13	Special handling or shipping requirements of repair materials should be avoided.

Guidelines by Category (Cont'd)

Category No.	Category Title	Guideline No.	Guideline
3.03.03	Crew Stations, Crew Cabs, Cockpits, and Personnel Enclosures		Doors and panels containing blade seals used for signature reduction should be interchangeable or contain interchangeable blade seals. Deviation is acceptable where repairs can be accomplished on the vehicle in a time equal to or less than door or seal remove and replace time.
		MC-01	All clamps should contain torque-set or torque-limiting connections to prevent clamp or component failure due to over-torque. Clamp installation call outs should not depend on special tools to establish the required torque values.
		MC-02	Avoid the use of cotter pins, safety wire, safety clips, and similar devices to prevent maintenance-induced events leading to ground vehicle accidents or loss of air vehicles.
		MC-03	All tubing connections and interfaces should use rosan/dynatube (or equivalent) to (1) enable connect or disconnect with one hand, one tool, (2) eliminate the need to safety the connection, (3) provide a superior seal, and (4) negate need to reposition line(s) during component replacement.
		MC-04	No trombone type, flared tube type, or piloted line type interfaces should be used to avoid the need for removal or repositioning during equipment removal.
		MC-05	Avoid potential foreign object traps during manufacturing or operational maintenance by eliminating vertical penetrations of plumbing/fittings into tanks, compartments, or cells
		MC-06	Locate, position, orient all plumbing and duct electrical connectors to prevent the need for sequential installation or removal.
		MC-09	All plumbing connections and fittings used for fuel systems should contain integral bonding features to eliminate the need for bonding clamps or jumper cables.
		MC-10	In rare instances where a plumbing run contains complex form or geometry that would require removal of other plumbing or equipment for access, in-line connectors should be incorporated to maintain the integrity of other plumbing or equipment.
		MC-11	No subsystem plumbing, equipment, or wiring should use a tank, cell, or compartment containing liquids as a means for routing or penetration simplicity during manufacture.
		MC-12	All plumbing and connectors containing liquids should be meniscus-free.
		MC-13	In instances where plumbing or connector interfaces cannot or are not keyed for a specific orientation, all identification, markings, cautions, and directions should be placed 360 degrees around the tube or duct.
		MC-14	Where multiple connectors are located in close proximity, ensure (1) a minimum hand tool arc of 120 degrees can be maintained, and (2) stagger fittings to ensure firm coupling interface/hand tool interface can be accomplished without inducing damage to adjacent lines.
		MC-15	Route, orient, and position plumbing, wiring, ducts, and connectors sufficiently away from the outer surface of the vehicle to preclude induced damage due to minor dents, drill bits during repair, etc. Minimum rule of thumb is 1" away from the inner surface and 1" below a plate nut channel.
		MP-01	Avoid the use of epoxies to mount parts on repairable modules because they make repair extremely difficult.
		MP-02	Use a unique identification (ID) resistor incorporated in each system module to verify that the proper module is mounted on ATE.
		MP-03	Design modules so that lengthy warm-up times, special coding and air purity levels, and similar constraints are not necessary.
		OXY-05	Locate liquid oxygen (LOX) containers in a sealed, dedicated compartment to eliminate need for frequent visual inspections.
		OXY-12	LOX compartments should be sealed from adjacent compartments and should contain dedicated overboard drains.
		P-01	Access door and panel fastener types for airborne vehicles should meet the following criteria: - use latches for a frequency of access of 0 to 40 flight hours - use High Strength Quick Release fasteners for a frequency of access of 40-400 flight hours - use structural screws for a frequency of access of 400 flight hours or more
		P-02	Access door and panel fastener types for surface vehicles should meet the following criteria: - use a spring loaded or latch fastener for an opening frequency of daily - use a one quarter turn fastener (or equivalent) for a opening frequency of weekly - use screws or bolts for all other cases

Guidelines by Category (Cont'd)

Category No.	Category Title	Guideline No.	Guideline
3.03.03	Crew Stations, Crew Cabs, Cockpits, and Personnel Enclosures	P-03	All doors and panels subject to environmental elements should contain form-in-place seals (or equivalent) attached to the door structure, not substructure, to prevent damage during maintenance.
		P-04	Door and panel seals should be compatible with all types of on-board servicing fluids, de-ice and anti-ice fluids, and all fluids used for chemical, biological, and nuclear decontamination.
		P-05	Piano type hinges should not be used on doors or panels because they are subject to wear, corrosion, and sand and fluid entry.
		P-06	Access door and panel devices used to support door in opened position should meet the following criteria: - for airborne vehicles, design for 60 knot gust loads (or equivalent jet blast loads) - for ground vehicles, design for 50 mph gust loads
		P-07	Hinged access doors and panels capable of remaining in the opened position should not have sharp edges or corners.
		P-08	Removable access door and panel fasteners should be of identical grip length and diameter.
		P-09	Acceptable door and panel hold-open devices include over-center sheet metal spring, over-center spring link, spring cartridge, support strut, and pinned goose neck hinge.
		P-10	Access doors and panels requiring non-captive fasteners should not be located forward of air inlet ducts or high-energy rotating components (e.g., prop fans, engine cooling fans, etc.).
		P-11	Access doors and panels should be interchangeable as justified by operation and support costs or life cycle costs.
		PERS-01	Group man-machine interfaces manifold-style to enable connect/disconnect in a single action.
		PERS-02	Include an integral, highly visible indicator in a man-machine interface connector to denote connector is seated and locked.
		PERS-03	Design interface connectors so that a distinct action is required by an individual to effect a disconnect. (Excludes airframe-to-ejection seat personnel interfaces.)
		PERS-04	Interfaces should contain an emergency release mechanism that can be activated by rescue personnel with a 95 percentile gloved hand.
		PERS-05	Design emergency interface release mechanisms to be clearly visible under all types of lighting situations.
		PERS-06	Storage bins, compartments, sacks, or bags should be available within the vehicle to store/protect all personal equipment required to conduct operations.
		PERS-07	All flight and ground vehicles should contain one cubic foot minimum storage compartment(s) for various loose and sundry personal items (for each individual).
		PERS-08	Design stowage and mounting provisions for portable air or oxygen containers to withstand 40G crash or impact loads.
		PERS-09	Design portable emergency locator beacons, radio receiver/transmitters, global positioning systems, and similar battery operated devices with integral provisions for determining battery health or status and remaining battery life.
		PYRO-01	Provide the "safe/arm" status to the pilot, crew, or gunner in the cockpit, crew station, or operator station as appropriate.
		PYRO-02	Provide the "safe/arm" status as an external cue discernible from a distance of 10-20 feet.
		PYRO-07	Manual "safe/arm" mechanisms should be well-clear of inlet ducts, propellers, rotors, and similar rotating components.
		PYRO-08	Manual "safe/arm" mechanisms should be well-clear of engine exhausts, fuel/toxic vents, fluid drains, control surface deflection envelopes, and rescue path envelopes.
		PYRO-14	Design weapon drop and fire/release circuits with frequency-coded firing systems or similar concepts to ensure stray energy tests and checks will not be required and that stray energy will not impose a safety hazard or problem.
		PYRO-22	A "rounds remaining" status should be available at the gun loading interface, maintenance panel, or cockpit/crew station/operator station.
		PYRO-32	Provide sufficient longitudinal clearance between weapon bays to enable simultaneous loading of two bays.
		PYRO-33	Provide sufficient lateral clearance between weapon bays to enable simultaneous loading of two bays.
		SABCH-01	Do not locate auxiliary air inlets, sensors, access doors, or drains in boundary bleed areas.
		SABCH-02	All flush type structural screws should have identical head drives for the entire vehicle.
		SABCH-03	All non-flush type structural screws should have identical head drive recesses for the entire vehicle.

Guidelines by Category (Cont'd)

Category No.	Category Title	Guideline No.	Guideline
3.03.03	Crew Stations, Crew Cabs, Cockpits, and Personnel Enclosures	SABCH-04	Special high strength bolts, such as twelve-point heads, should be fully justified from standpoint of the cost of ownership and effectiveness.
		SABCH-05	Structural design should avoid the reliance on blind fasteners unless fully supported by cost, weight, schedule, and effectiveness analysis.
		SABCH-06	Structural design should avoid the potential of dissimilar material or fastener corrosion.
		SABCH-07	No structural fasteners should be used that require special tools for installation.
		SABCH-08	Taper pins should be threaded and retained with self-locking hardware.
		SABCH-09	Pins and collars (lockbolts) should only be used in applications which do not normally require removal.
		SABCH-10	Do not use lockbolts in composites.
		SABCH-11	In rare instances where the use of dissimilar material in immediate contact cannot be avoided, they should be sufficiently insulated to endure for the life of the vehicle.
		SABCH-12	Avoid tapping threads into structural members. Use of heli-coil type or similar insert concepts is permissible.
		SABCH-13	No structural design concept should rely on frequent scheduled inspections to monitor or otherwise ensure structural integrity.
		SABCH-14	No structural fastener intended to carry shear or tension loads should be smaller than 1/4" diameter (.25").
		SABCH-15	Give preference to butt type splices over lap type splices in the design of manufacturing splices.
		SABCH-16	Wing-to-fuselage attachment should give preference to tension ties over shear ties to improve overall volumetric efficiency.
		SABCH-17	Hardpoints for securing tie down chains, cables, and devices during transport should not require reaching under or crawling under the vehicle.
		SABCH-18	Rings, posts, and clevis devices used for attaching tie downs should not require opening of doors or panels for access.
		SABCH-19	Avoid tie down concepts requiring attaching hardpoints as a prerequisite.
		SABCH-20	Location of hardpoints used for tie down attachment should: - Remain outside of door and panel opening envelopes. - Be clear of exhaust pipes, ducts, manifolds, and mufflers. - Be clear of overboard fluid drains and vents.
		SAFE-02	Emergency ingress actuation provisions into cockpits, crew stations, passenger compartments, and operator stations should be accessible from the ground by 5 percentile females.
		SAFE-03	Stored energy devices (e.g., accumulators, nitrogen bottles, gas generators, etc.), that could cause injury, harm, or damage if inadvertently actuated, should contain integral safing provisions.
		SAFE-05	Crash locator beacon door opening/ejection mechanisms should contain integral electrical safe/arm features.
		SAFE-08	A single lever safety should, when positioned, safe the entire escape/ejection system. Use of the single lever to "arm" should require two hands.
		SAFE-09	Safing the canopy jettison system should be accomplished through the same lever device used to safe the ejection seat.
		SAFE-11	All individual safety pins used for ground maintenance should be clearly visible and coupled together to ensure no single pin will be overlooked during arming.
		SEAT-01	Design personnel seats and padding materials, including the covers and fillers, so they are incapable of creating or emitting toxic fumes or dense smoke when subjected to fire.
		SEAT-02	Design personnel seats and padding materials so they are incapable of absorbing and holding fluids.
		SEAT-04	Design ejection seats so they can be replaced with canopy or escape hatch installed.
		SEAT-05	Design ejection seat pyrotechnic devices so they are 100 percent viewable and accessible with seat installed.
		SEAT-06	Do not use seat removal as a means of access.
		SURV-01	Design containers used for dinghy stowage to be structurally capable of containing the dinghy within the event of unintentional or uncommanded inflation.

Guidelines by Category (Cont'd)

Category No.	Category Title	Guideline No.	Guideline
3.03.03	Crew Stations, Crew Cabs, Cockpits, and Personnel Enclosures		Provide crew stations, crew compartments, and operator areas containing dinghies as emergency equipment with a suitable tool for puncturing or cutting the dinghy in the event of inadvertent inflation. Locate the tool so that access is assured during dinghy inflation.
		T-01	Do not locate pyro, gas, and air (PGA) control system exhaust exits: - In proximity to safe, arm, or servicing areas, - Adjacent to auxiliary inlets, - In close proximity to crew boarding areas, weapons, emergency ingress/egress areas, and optics or optical glass.
		T-02	Design pyro type thruster exits associated with emergency use or backup with simple exit closure devices to identify if a thruster has been fired.
		T-03	Provide protective screens for PGA exits that normally remain open to prevent intrusions from fowl or wildlife.
		T-04	Provide protective closure provisions for PGA exits located or oriented to exposure from the elements.
		T-05	Design single-shot (one time use) type thrusters with a minimum 6-year shelf life and a 7-year installed life.
		W-01	Hat section type structural stiffeners with sufficient cross sectional area should be considered as a routing tunnel for wiring and coax.
		WBAY-01	Equipment bays and compartments should not require installation of special cavity fillers when equipment is not installed.
		WBAY-18	The proximity of the gun firing barrel to structure should be such that structural furrows or channels are not required for projectile clearances during firing.
		WIND-01	Optical window materials should be scratch resistant, easy to clean, and dissipate electrostatic charges.
		WIND-02	Optic windows should be located for ease of inspection, cleaning, and induced damage potential from personnel or support equipment.
		WIND-03	Window locations should minimize the effects of contamination by salt spray, bugs, oils, fuels, and icing.
		WIND-04	Window, canopy, and windshield material should be designed to withstand the effects of sandstorms in the ground environment and the effects of rain and hail during thunderstorm penetration in the airborne environment.
		WIND-05	Design interior surfaces to be reachable for cleaning without reliance on hinging, equipment removal, or use of support equipment.
		WIND-06	Do not locate windows in the proximity of rooster tails created by wheels/tires passing through water or slush.
		WIND-07	Use materials that are highly resistive to thermal shock.
		WIND-11	For dome-shaped optic window concepts, the dome should be easily removable for cleaning without affecting LO integrity.
		WIND-12	Design EO windows and optics to be interchangeable among the same air vehicle types or same ground vehicle types.
		WIND-13	The combination of material layers and coatings for optics and windows should be such that static charge buildup for worst case conditions should not exceed 10,000 volts.
		WIND-14	Exterior lights should permit simple and rapid bulb replacement without disturbing LO treatments.
		WIND-15	Design light covers and lenses to be sufficiently durable so that protective covers are not needed during maintenance.
		WIND-16	Lens shape should enhance LO capability to reduce need, care, and expense for special coatings.
		WT&B-13	Emergency brake handles should not be similar in shape or color as other handles nor should they be located in close proximity to such other handles.
3.03.04	Access Doors, Panels, and Openings	A-01	Seal equipment bays and compartments against the environmental elements including all types of servicing fluids used for the vehicle, all types of anti-ice and de-ice fluids, and all types of fluids used for chemical, biological, or nuclear decontamination
		A-07	Paint equipment bay and compartment interiors a high gloss white to maximize lighting reflectivity, visibility, and rapid leak detection capability.
		A-11	Locate compartment electrical penetrations close to the access opening for ease of sight, probing, repair, and to eliminate fluid soaking, wicking, or contamination.
		A-12	Locate compartment electrical penetrations far enough from the access opening to prevent damage resulting from improper (over-length) panel fasteners.

Guidelines by Category (Cont'd)

Category No.	Category Title	Guideline No.	Guideline
3.03.04	Access Doors, Panels, and Openings	A-13	Two-sided or two-surfaced access should not be required for access to equipment interfaces and handpoints. The term two-sided infers top/bottom, left/right, front/back, or combinations thereof.
		A-14	Do not locate nutplates or gang channels in inaccessible areas that would require extensive disassembly or equipment removal to gain access.
		A-15	Locate tie-down attachment points such that tie-down chains, straps, or cables do not prevent or restrict normal servicing, weapon loading, or safe/arm functions.
		A-16	Structural design should provide good access to corrosion-prone areas for inspection and treatment.
		A-17	All structural fasteners in an access door or panel should be of identical grip and diameter. In rare cases where this is not possible, fasteners of different grip must have different diameters to prevent a shorter fastener being substituted for the correct, longer fastener.
		A-18	Use transparent windows, quick-opening covers, or openings without any cover to permit quick visual inspections where needed.
		AA&S-02	Closure and sealing of cavities, compartments, and wells for retractable antennas should be mechanized to function as part of the extend and retract cycle.
		AA&S-03	Closure and sealing of cavities, compartments, and wells for retractable antennas should be maintained when antennas are not installed without need for ancillary measures or equipment.
		ARM-02	For an aircraft, the fuselage lower shear moldline should be no less than 50" above the ground when internal weapons will be carried in the fuselage and weapon bay door widths exceed 22".
		BIT-06	Mission critical functions should be monitored by BIT.
		BIT-09	Use concurrent BIT to monitor system critical functions.
		BIT/BITE-02	Design EMI protection to eliminate finger type EMI contact devices.
		CBR-01	Orient all vehicle liquid servicing fittings to ensure fluids will not come in contact with protective garb during connect/disconnect activities.
		CBR-02	Ensure vehicle overboard passive liquid drains are clearly marked or visible to enable personnel to remain clear of area.
		CBR-03	Design fuel cell drains so they can not be activated in a manner that would allow fuel to come in contact with a protected hand.
		CBR-04	Design emergency ingress provisions so they can be activated by a 95 percentile male wearing full protective chemical or biological protection gear.
		CBR-05	Size rescue doors, panels, and "cut here" areas to accommodate the 95 percentile shoulder width wearing full protective chemical or biological protection gear.
		CONT-06	Design all pulleys and brackets associated with cable installations so they are accessible by a 75 percentile male hand.
		D&V-01	The geometric aspects of structural design and interfaces should not result in any natural bathtubs.
		D&V-02	Closed structural sections subject to condensation or fluid migration should contain drainage provisions.
		D&V-03	Crew cabs, operators' compartments, crew stations, cockpits, and passenger compartments should be subject to the same corrosion prevention measures as the exteriors of the vehicles. Low points, pockets, and related fluid collection points within should be provided with low point drains.
		EC-08	Locate and position electrical connectors such that all pin identification for either half can be easily seen.
		ECS-01	Design so that equipment servicing status are accessible and readable from the ground level for air vehicles and from the operator's position for ground and water vehicles.
		ECS-02	Do not locate equipment servicing points in crew, passenger, or operator areas.
		ECS-04	Plumbing, lines, or hoses containing hot liquids, toxic gases or liquids should be external to operator, crew, or passenger stations.
		ECS-05	Access, removal, and installation of all type filter elements should be possible without removing the assembly or disconnecting any filter package interfaces.
		ECS-11	Design air inlets, outlets, and exhausts to be accessible without reliance on ladders or work stands for ease of installing protective plugs or covers.

Guidelines by Category (Cont'd)

Category No.	Category Title	Guideline No.	Guideline
3.03.04	Access Doors, Panels, and Openings	ECS-12	Design air inlets, outlets, and exhausts with screens to prevent bird or rodent entry.
		ECS-13	Design air inlets, outlets, and exhausts to be meniscus-free to prevent a bathtub effect. In remote instances where this is not possible, passive drains should be provided at all low points to prevent liquid accumulation with the vehicle in its normal static attitude.
		ECS-14	Instances where air inlets, outlets, and exhausts are subject to water entry, passive drains should be employed capable of handling 4" of rain per hour.
		ECS-15	Locate and orient air inlets, outlets, and exhausts in a manner that prevents their use as footholds during maintenance.
		ECS-28	Install and orient air supply and distribution ducts so they clear all access openings and equipment removal envelopes.
		EDECOM-01	Provide surface sensors on equipment located in compartments containing louvers, screens, flush inlets, or similar openings to the environment to indicate the presence of chem/bio contaminants.
		EDECOM-02	Provide integral sensors (viewable from the exterior) for equipment subject to internal forced-air cooling from outside or external air to indicate the presence of contaminants.
		EDECOM-03	Design equipment surfaces and structure to be compatible with all decontamination agents and methods.
		EDECOM-04	Provide passive overboard drains in compartments subject to decontamination processes to void the area of contaminants.
		EDECOM-05	Provide hoist, lift or transport handles for equipment requiring removal from the host vehicle for decontamination. In instances where this may not be practical, design the equipment with hardpoints for attaching parasitic carrying provisions
		ENG-09	On multi-engine air vehicles, the engines should be capable of being installed in any engine cavity without need for reconfiguration.
		ENG-10	On multi-engine air vehicles, the airframe-to-engine interfaces should be in identical positions or orientations for each engine cavity.
		ENG-12	All engine-mounted accessories must be capable of being removed and installed through the available airframe access openings.
		ENG-16	Aircraft jacking should not be required for engine removal.
		ENG-17	Aft engine removal should be an acceptable alternative for USAF aircraft.
		ENG-18	For either downward or aft engine removal, it should be possible to maintain control of the engine on all axis during the entire removal and installation process.
		ENG-19	The minimum clearance between engine and airframe should be 1 inch, including removal and installation.
		ENG-20	Do not locate equipment or components in the engine cavity except for those components associated with the engine or engine installation.
		ENG-21	Do not locate equipment or components in the engine bay cavity in a manner that would require removal or repositioning for engine removal.
		ENG-22	The engine cavity structure should be capable of withstanding a 2000-degree Fahrenheit fire for 10 minutes without jeopardizing loss of the vehicle.
		ENG-23	All engine borescope provisions should be accessible with the engine installed and hooked up.
		ENG-24	Replacement of all ignitors should be possible with the engine installed.
		ENG-25	All engine-to-airframe plumbing, wiring, and duct interfaces should be capable of being connected or disconnected by hand, should contain integral safety provisions, and should not require torquing.
		ENG-26	Locate and position engine overheat and fire warning sensors so that damage cannot occur during engine maintenance or replacement.
		ENG-30	It should not be necessary to close or reinstall engine access doors for engine ground operation up to and including military power.
		ENV-01	Materials, treatments, coatings, finishes should be compatible with all anti-ice and de-ice fluids, chemical and biological decontamination fluids, washing and cleaning fluids, and all vehicle subsystem fluids.
		ENV-02	There should be no top coat or treatment deterioration throughout the standard temperature and humidity spectrum.
		ENV-06	For ground vehicles, the finishes should be compatible with and durable against all rain, hail, sleet, snow, and ice conditions experienced in all intended operational environments.

Guidelines by Category (Cont'd)

Category No.	Category Title	Guideline No.	Guideline
3.03.04	Access Doors, Panels, and Openings	EXT-01	Locate Tanks, Pods, Containers, and Devices (TPCD's) so they do not block or restrict access to existing vehicle access areas or access approach envelopes.
		EXT-05	Design access doors for cargo type TPCD's to be non-load carrying and with simple latches for all doors and panels.
		FUEL-01	Locate fuel vent and dump masts to ensure exiting fuel will be clear of servicing, loading, arming and safing areas for all types of ground and airborne vehicles.
		FUEL-02	Manufacturing splices for major sub-assemblies should not intrude into or through integral fuel cells or tanks.
		FUEL-03	Structural bolts, screws, and fasteners should not penetrate into integral fuel cells or tanks other than those used for access door attachment.
		FUEL-04	Where the fuel wetted area inside a fuel cell or tank is void of blade, knife, and hat stiffeners for use as hardpoint attachment, standoff's bonded to the cell surface should be used as attachments for clamps, and brackets to eliminate fastener penetration of the fuel cavity.
		FUEL-05	Intersecting of two or more surfaces in a fuel wetted area of less than 90 degrees should be avoided to simplify manufacture and repair.
		FUEL-06	Where maintaining a minimum angle of 90 degrees is not possible, sufficient depth, width, and height should be maintained to provide tool clearances for all tools used in the manufacturing processes and in the operational field repair environment.
		FUEL-08	The size and number of fuel cell and tank access doors should be sufficient to ensure no wetted area of the cell or tank is beyond a maximum 18" distance from the edge of the access opening. This guideline applies to only non-man rated cells.
		FUEL-09	All fuel cell or tank access doors not mounted on the exterior surface should contain sealing provisions other than the channel type.
		FUEL-10	Provide access from the wing closure ribs in lieu of the moldline when access is required in close proximity to the wing fold area.
		FUEL-11	Through-the-tank fasteners should not be used for fuel cells or tanks in areas where a leak path could be established into an inaccessible portion of the vehicle.
		HOOK-06	Avoid the need to remove the tail hook to facilitate engine access or removal.
		HYD-01	For military combat vehicles having two or more hydraulic power systems, provide a minimum 30-inch spacing between ground power and servicing interfaces to ensure: <ul style="list-style-type: none"> - Design flexibility in locating and arranging equipment in high-density vehicles such as fighters and helicopters, - Work area separation to enable concurrent service/maintenance on systems, - Systems vulnerability enhancement, - Reduction in turn-around elapsed time due to concurrent servicing capability.
		IN(V)-02	Do not use loose structural fasteners in the access area to inlet door actuators and mechanisms. Where this guideline cannot be followed, design the actuator door to be accessible only when the inlet doors are fully closed.
		IN(V)-03	For engine inlet bellmouth fairings, use methods of retention other than fasteners. Latches may be considered as an acceptable alternative only if latch-to-panel retention is from the inner mold line.
		IN(V)-04	Design inlet doors and inlet bellmouth fairings to be fully interchangeable to eliminate the need to cut, file, or trim at the engine face.
		IN(V)-05	Locate the inlet duct edge a minimum of 60 inches from the cockpit or crew station to eliminate restricting engine operation to canopy-closed conditions.
		IN(V)-06	Use captive fasteners on all access doors forward of the inlet to significantly reduce engine FOD potential.
		IN(V)-08	Incorporate an inlet closure door sealing concept that prevents entry of fluid, dust, or sand across the entire airborne and ground environment spectrum.
		LG-31	Landing gear doors designed to close after gear is extended should be capable of being manually opened on the ground without reliance on electrical or hydraulic power.
		LG-32	Design of landing gear doors normally closed after gear extension should ensure failure modes will not enable uncommanded opening on the ground.

MIL-HDBK-470A

APPENDIX C

Guidelines by Category (Cont'd)

Category No.	Category Title	Guideline No.	Guideline
3.03.04	Access Doors, Panels, and Openings	LG-33	Design of landing gear doors normally left open after gear extension should ensure no failure mode will enable closing on the ground.
		LG-34	Avoid sharp edges and corners on landing gear doors or fairings.
		LG-35	Avoid the use of landing gear doors to mount or house antennas, arrays, or air data sensors.
		LO-01	Use LO compatible gap fillers for manufactured gaps in lieu of tape and butter (surface coating compound).
		LO-02	Avoid scheduled forced inspections or replacement of materials, coatings, or finishes solely to protect either the reliability or the signature.
		LO-03	Equipment and support structure requiring shrouds to reduce radar returns should not cause increases in equipment service/repair time.
		LO-04	Infrequently-accessed structural doors and panels incorporating special coatings or conductive paints should contain provisions for prying the door or panel clear of moldline with standard screwdriver without damage.
		LO-05	Do not locate flush mounted LO screens for auxiliary air inlets and exits in walkway areas unless durability has been proven.
		LO-06	Size flush mounted LO screens for auxiliary air inlets and exits to ensure functionality with up to 25 percent of the openings plugged.
		LO-07	Flush and non-flush LO screens should be interchangeable.
		MATL-02	Cosmetic type repairs should not exceed 1 hours including cure or drying times.
		MATL-03	Cosmetic and vehicle repair material shelf life should not be less than 24 months.
		MATL-04	Cosmetic and vehicle repair materials should be non-proprietary and non-single source.
		MATL-05	Cosmetic and vehicle repair materials should not require refrigeration or special facilities or atmospheres for storage.
		MATL-06	Repair criteria, repairs, and instructions should not be classified.
		MATL-07	All cosmetic touch-up and repair materials should be environmentally safe.
		MATL-08	Repairs (other than major depot repair) should not require autoclave type facilities.
		MATL-09	A high degree of durability should be achieved across all walkway areas on the top surfaces of all vehicles up to and including 95 percentile personnel.
		MATL-10	Coatings and finishes should be durable against the effects of missile gases, velocities, and particles emanating from the missile motor.
		MATL-11	Coatings and finishes should be durable against the effects of gun gases, projectile shock waves, and brass particles emanating from the projectile seal rings.
		MATL-13	Special handling or shipping requirements of repair materials should be avoided.
		MATL-15	Doors and panels containing blade seals used for signature reduction should be interchangeable or contain interchangeable blade seals. Deviation is acceptable where repairs can be accomplished on the vehicle in a time equal to or less than door or seal remove and replace time.
		MC-06	Locate, position, orient all plumbing and duct electrical connectors to prevent the need for sequential installation or removal.
		MC-09	All plumbing connections and fittings used for fuel systems should contain integral bonding features to eliminate the need for bonding clamps or jumper cables.
		MC-14	Where multiple connectors are located in close proximity, ensure (1) a minimum hand tool arc of 120 degrees can be maintained, and (2) stagger fittings to ensure firm coupling interface/hand tool interface can be accomplished without inducing damage to adjacent lines.
		MC-15	Route, orient, and position plumbing, wiring, ducts, and connectors sufficiently away from the outer surface of the vehicle to preclude induced damage due to minor dents, drill bits during repair, etc. Minimum rule of thumb is 1" away from the inner surface and 1" below a plate nut channel.
		OXY-07	Locate liquid oxygen containers to ensure simultaneous replacement with other turnaround activities.
		OXY-12	LOX compartments should be sealed from adjacent compartments and should contain dedicated overboard drains.

MIL-HDBK-470A

APPENDIX C

Guidelines by Category (Cont'd)

Category No.	Category Title	Guideline No.	Guideline
3.03.04	Access Doors, Panels, and Openings	P-01	Access door and panel fastener types for airborne vehicles should meet the following criteria: <ul style="list-style-type: none"> - use latches for a frequency of access of 0 to 40 flight hours - use High Strength Quick Release fasteners for a frequency of access of 40-400 flight hours - use structural screws for a frequency of access of 400 flight hours or more
		P-02	Access door and panel fastener types for surface vehicles should meet the following criteria: <ul style="list-style-type: none"> - use a spring loaded or latch fastener for an opening frequency of daily - use a one quarter turn fastener (or equivalent) for a opening frequency of weekly - use screws or bolts for all other cases
		P-03	All doors and panels subject to environmental elements should contain form-in-place seals (or equivalent) attached to the door structure, not substructure, to prevent damage during maintenance.
		P-04	Door and panel seals should be compatible with all types of on-board servicing fluids, de-ice and anti-ice fluids, and all fluids used for chemical, biological, and nuclear decontamination.
		P-05	Piano type hinges should not be used on doors or panels because they are subject to wear, corrosion, and sand and fluid entry.
		P-06	Access door and panel devices used to support door in opened position should meet the following criteria: <ul style="list-style-type: none"> - for airborne vehicles, design for 60 knot gust loads (or equivalent jet blast loads) - for ground vehicles, design for 50 mph gust loads
		P-07	Hinged access doors and panels capable of remaining in the opened position should not have sharp edges or corners.
		P-08	Removable access door and panel fasteners should be of identical grip length and diameter.
		P-09	Acceptable door and panel hold-open devices include over-center sheet metal spring, over-center spring link, spring cartridge, support strut, and pinned goose neck hinge.
		P-10	Access doors and panels requiring non-captive fasteners should not be located forward of air inlet ducts or high-energy rotating components (e.g., prop fans, engine cooling fans, etc.).
		P-11	Access doors and panels should be interchangeable as justified by operation and support costs or life cycle costs.
		PERS-06	Storage bins, compartments, sacks, or bags should be available within the vehicle to store/protect all personal equipment required to conduct operations.
		PERS-07	All flight and ground vehicles should contain one cubic foot minimum storage compartment(s) for various loose and sundry personal items (for each individual).
		PERS-08	Design stowage and mounting provisions for portable air or oxygen containers to withstand 40G crash or impact loads.
		PYRO-20	Weapon bay doors, when opened, should not block or restrict access to other servicing points.
		PYRO-31	Ensure weapon bay door open positions do not intrude into any other door opening envelope.
		PYRO-32	Provide sufficient longitudinal clearance between weapon bays to enable simultaneous loading of two bays.
		PYRO-33	Provide sufficient lateral clearance between weapon bays to enable simultaneous loading of two bays.
		PYRO-34	Weapon bay door seals should be bonded or attached to door structure to minimize induced seal damage during weapon or store loading.
		SABCH-01	Do not locate auxiliary air inlets, sensors, access doors, or drains in boundary bleed areas.
		SABCH-02	All flush type structural screws should have identical head drives for the entire vehicle.
		SABCH-03	All non-flush type structural screws should have identical head drive recesses for the entire vehicle.
		SABCH-04	Special high strength bolts, such as twelve-point heads, should be fully justified from standpoint of the cost of ownership and effectiveness.
		SABCH-05	Structural design should avoid the reliance on blind fasteners unless fully supported by cost, weight, schedule, and effectiveness analysis.
		SABCH-06	Structural design should avoid the potential of dissimilar material or fastener corrosion.
		SABCH-07	No structural fasteners should be used that require special tools for installation.
		SABCH-08	Taper pins should be threaded and retained with self-locking hardware.
		SABCH-09	Pins and collars (lockbolts) should only be used in applications which do not normally require removal.

MIL-HDBK-470A

APPENDIX C

Guidelines by Category (Cont'd)

Category No.	Category Title	Guideline No.	Guideline
3.03.04	Access Doors, Panels, and Openings	SABCH-10	Do not use lockbolts in composites.
		SABCH-11	In rare instances where the use of dissimilar material in immediate contact cannot be avoided, they should be sufficiently insulated to endure for the life of the vehicle.
		SABCH-12	Avoid tapping threads into structural members. Use of heli-coil type or similar insert concepts is permissible.
		SABCH-13	No structural design concept should rely on frequent scheduled inspections to monitor or otherwise ensure structural integrity.
		SABCH-14	No structural fastener intended to carry shear or tension loads should be smaller than 1/4" diameter (.25").
		SABCH-15	Give preference to butt type splices over lap type splices in the design of manufacturing splices.
		SAFE-01	Drag chute installation designs not containing electrical safing should contain remote safe/arm provisions reachable from ground level by 5 percentile females. Remove location should be clear of engine exhaust areas and flight control deflection envelopes.
		SAFE-05	Crash locator beacon door opening/ejection mechanisms should contain integral electrical safe/arm features.
		SE-04	Gun port covers or plugs should be lightweight, 100% effective, and easy to install or store.
		SEAT-04	Design ejection seats so they can be replaced with canopy or escape hatch installed.
		SEAT-05	Design ejection seat pyrotechnic devices so they are 100 percent viewable and accessible with seat installed.
		SEAT-06	Do not use seat removal as a means of access.
		SIMP-01	Location and design of all exterior lights should not require protective covers in ground environments.
		SIMP-02	Landing and taxi lights should be mounted on landing gear struts or doors to eliminate separate compartments, doors, and retraction/extension mechanisms.
		SIMP-03	Speed brake or speed brake cavity should contain integral mechanical locking mechanism for personnel safety.
		WBAY-01	Equipment bays and compartments should not require installation of special cavity fillers when equipment is not installed.
		WBAY-12	Pylon-to-store/weapon gap seal should permit visual and physical access during loading for all interfaces between bomb rack-to-store, bomb rack-to-launcher, and launcher-to-store.
		WBAY-17	Special coatings or conductive paints on pylons, launchers, racks, launchers, tanks, pods, etc. should have the durability to withstand contact with support stands/cradles during storage.
		WBAY-19	Frangible gun ports should take preference over mechanized gun port doors.
		WBAY-20	Gun plugs required solely to maintain a given signature level should be capable of on-board stowage for use only when a threat requires their presence.
3.03.05	Windshields, Windows, Canopies, and Optics	A-01	Seal equipment bays and compartments against the environmental elements including all types of servicing fluids used for the vehicle, all types of anti-ice and de-ice fluids, and all types of fluids used for chemical, biological, or nuclear decontamination
		A-02	Equipment bay and compartment structure should be bonded, co-cured, welded, machined, or combinations thereof to eliminate or minimize the use of mechanical fasteners.
		A-03	All equipment bay and compartment structural flanges and stiffeners should be external to the compartment to maximize the volume available for equipment installation and arrangement.
		A-13	Two-sided or two-surfaced access should not be required for access to equipment interfaces and hardpoints. The term two-sided infers top/bottom, left/right, front/back, or combinations thereof.
		BIT-06	Mission critical functions should be monitored by BIT.
		BIT-09	Use concurrent BIT to monitor system critical functions.
		BIT/BITE-02	Design EMI protection to eliminate finger type EMI contact devices.
		CREW-07	Electronic and photosensitive storage media should withstand the adverse environment created by ground, flightline, or shipboard electromagnetic fields and light sources.
		D&V-01	The geometric aspects of structural design and interfaces should not result in any natural bathtubs.
		D&V-02	Closed structural sections subject to condensation or fluid migration should contain drainage provisions.

Guidelines by Category (Cont'd)

Category No.	Category Title	Guideline No.	Guideline
3.03.05	Windshields, Windows, Canopies, and Optics	D&V-03	Crew cabs, operators' compartments, crew stations, cockpits, and passenger compartments should be subject to the same corrosion prevention measures as the exteriors of the vehicles. Low points, pockets, and related fluid collection points within should be provided with low point drains.
		ECS-27	Use temperature-limiting devices with high temperature air systems to ensure no single or combination of surface wind, cross wind, ground operation or flight operation will damage windshields, canopies, windows or optics.
		ENV-01	Materials, treatments, coatings, finishes should be compatible with all anti-ice and de-ice fluids, chemical and biological decontamination fluids, washing and cleaning fluids, and all vehicle subsystem fluids.
		ENV-02	There should be no top coat or treatment deterioration throughout the standard temperature and humidity spectrum.
		ENV-03	For airborne vehicles, the finishes should be durable against rain, hail, and dynamic erosion throughout the flight envelope.
		ENV-04	For airborne and ground vehicles, the finishes should be durable against sand erosion throughout all surface wind speeds experienced in arid or desert geographical locations.
		ENV-06	For ground vehicles, the finishes should be compatible with and durable against all rain, hail, sleet, snow, and ice conditions experienced in all intended operational environments.
		LO-01	Use LO compatible gap fillers for manufactured gaps in lieu of tape and butter (surface coating compound).
		LO-02	Avoid scheduled forced inspections or replacement of materials, coatings, or finishes solely to protect either the reliability or the signature.
		LO-03	Equipment and support structure requiring shrouds to reduce radar returns should not cause increases in equipment service/repair time.
		LO-04	Infrequently-accessed structural doors and panels incorporating special coatings or conductive paints should contain provisions for prying the door or panel clear of moldline with standard screwdriver without damage.
		LO-05	Do not locate flush mounted LO screens for auxiliary air inlets and exits in walkway areas unless durability has been proven.
		LO-06	Size flush mounted LO screens for auxiliary air inlets and exits to ensure functionality with up to 25 percent of the openings plugged.
		LO-07	Flush and non-flush LO screens should be interchangeable.
		MATL-06	Repair criteria, repairs, and instructions should not be classified.
		MATL-07	All cosmetic touch-up and repair materials should be environmentally safe.
		MATL-10	Coatings and finishes should be durable against the effects of missile gases, velocities, and particles emanating from the missile motor.
		MATL-11	Coatings and finishes should be durable against the effects of gun gases, projectile shock waves, and brass particles emanating from the projectile seal rings.
		MC-02	Avoid the use of cotter pins, safety wire, safety clips, and similar devices to prevent maintenance-induced events leading to ground vehicle accidents or loss of air vehicles.
		MC-06	Locate, position, orient all plumbing and duct electrical connectors to prevent the need for sequential installation or removal.
		MC-09	All plumbing connections and fittings used for fuel systems should contain integral bonding features to eliminate the need for bonding clamps or jumper cables.
		MC-10	In rare instances where a plumbing run contains complex form or geometry that would require removal of other plumbing or equipment for access, in-line connectors should be incorporated to maintain the integrity of other plumbing or equipment.
		MC-12	All plumbing and connectors containing liquids should be meniscus-free.
		MC-14	Where multiple connectors are located in close proximity, ensure (1) a minimum hand tool arc of 120 degrees can be maintained, and (2) stagger fittings to ensure firm coupling interface/hand tool interface can be accomplished without inducing damage to adjacent lines.
		PYRO-31	Ensure weapon bay door open positions do not intrude into any other door opening envelope.
		PYRO-32	Provide sufficient longitudinal clearance between weapon bays to enable simultaneous loading of two bays.

Guidelines by Category (Cont'd)

Category No.	Category Title	Guideline No.	Guideline
3.03.05	Windshields, Canopies, and Optics	PYRO-33	Provide sufficient lateral clearance between weapon bays to enable simultaneous loading of two bays.
		SABCH-01	Do not locate auxiliary air inlets, sensors, access doors, or drains in boundary bleed areas.
		SABCH-02	All flush type structural screws should have identical head drives for the entire vehicle.
		SABCH-03	All non-flush type structural screws should have identical head drive recesses for the entire vehicle.
		SABCH-04	Special high strength bolts, such as twelve-point heads, should be fully justified from standpoint of the cost of ownership and effectiveness.
		SABCH-05	Structural design should avoid the reliance on blind fasteners unless fully supported by cost, weight, schedule, and effectiveness analysis.
		SABCH-06	Structural design should avoid the potential of dissimilar material or fastener corrosion.
		SABCH-07	No structural fasteners should be used that require special tools for installation.
		SABCH-08	Taper pins should be threaded and retained with self-locking hardware.
		SABCH-09	Pins and collars (lockbolts) should only be used in applications which do not normally require removal.
		SABCH-10	Do not use lockbolts in composites.
		SABCH-11	In rare instances where the use of dissimilar material in immediate contact cannot be avoided, they should be sufficiently insulated to endure for the life of the vehicle.
		SABCH-12	Avoid tapping threads into structural members. Use of heli-coil type or similar insert concepts is permissible.
		SABCH-13	No structural design concept should rely on frequent scheduled inspections to monitor or otherwise ensure structural integrity.
		SABCH-14	No structural fastener intended to carry shear or tension loads should be smaller than 1/4" diameter (.25").
		SABCH-15	Give preference to butt type splices over lap type splices in the design of manufacturing splices.
		SAFE-08	A single lever safety should, when positioned, safe the entire escape/ejection system. Use of the single lever to "arm" should require two hands.
		SAFE-09	Safing the canopy jettison system should be accomplished through the same lever device used to safe the ejection seat.
		WIND-01	Optical window materials should be scratch resistant, easy to clean, and dissipate electrostatic charges.
		WIND-02	Optic windows should be located for ease of inspection, cleaning, and induced damage potential from personnel or support equipment.
		WIND-03	Window locations should minimize the effects of contamination by salt spray, bugs, oils, fuels, and icing.
		WIND-04	Window, canopy, and windshield material should be designed to withstand the effects of sandstorms in the ground environment and the effects of rain and hail during thunderstorm penetration in the airborne environment.
		WIND-05	Design interior surfaces to be reachable for cleaning without reliance on hinging, equipment removal, or use of support equipment.
		WIND-06	Do not locate windows in the proximity of rooster tails created by wheels/tires passing through water or slush.
		WIND-07	Use materials that are highly resistive to thermal shock.
		WIND-11	For dome-shaped optic window concepts, the dome should be easily removable for cleaning without affecting LO integrity.
		WIND-12	Design EO windows and optics to be interchangeable among the same air vehicle types or same ground vehicle types.
		WIND-13	The combination of material layers and coatings for optics and windows should be such that static charge buildup for worst case conditions should not exceed 10,000 volts.
		WIND-14	Exterior lights should permit simple and rapid bulb replacement without disturbing LO treatments.
		WIND-15	Design light covers and lenses to be sufficiently durable so that protective covers are not needed during maintenance.
		WIND-16	Lens shape should enhance LO capability to reduce need, care, and expense for special coatings.
3.03.06	Structures, Airframes, Bodies, Chassis, and Hulls	A-01	Seal equipment bays and compartments against the environmental elements including all types of servicing fluids used for the vehicle, all types of anti-ice and de-ice fluids, and all types of fluids used for chemical, biological, or nuclear decontamination

Guidelines by Category (Cont'd)

Category No.	Category Title	Guideline No.	Guideline
3.03.06	Structures, Airframes, Bodies, Chassis, and Hulls	A-02	Equipment bay and compartment structure should be bonded, co-cured, welded, machined, or combinations thereof to eliminate or minimize the use of mechanical fasteners.
		A-03	All equipment bay and compartment structural flanges and stiffeners should be external to the compartment to maximize the volume available for equipment installation and arrangement.
		A-04	Use stiffening beads in lieu of flanges to the maximum extent to enhance compartment volume and simplify repairs.
		A-05	Stiffening beads should have the convex surface toward the compartment to eliminate fluid traps.
		A-06	Keep all machined compartment frames, webs, and closure panels to a constant thickness (e.g., not stepped or tapered) to ease simplicity of fluid or electrical penetrations and ease and simplicity of structural repair.
		A-07	Hardpoints (structural attachment and load bearing areas) within a compartment to assist in equipment mounting or support should not be integral with the machined part. Hardpoints should be parasitic to enable quick repair in case of wear or damage in lieu of precise ream/bush repair typical of machined hardpoints.
		A-08	Paint equipment bay and compartment interiors a high gloss white to maximize lighting reflectivity, visibility, and rapid leak detection capability.
		A-09	Plumbing penetrations into a compartment should not be on a vertical axis due to difficulty in making or breaking vertically-oriented connections. When compartment access is from the bottom, vertically-oriented connections can allow fluid to leak onto the maintainer. When access is from the top, such connections can allow foreign matter to enter the line. Use horizontal penetrations whenever possible.
		A-10	Any heat or temperature sensitive structure within a compartment should contain heat-sensitive tape or appropriate heat sensor for easy indication of over-temperature excursions.
		A-13	Provide a sufficient number of compartment fluid drains to ensure fluid drainage for varying aircraft static attitudes and varying terrain slopes for ground vehicles.
		A-16	Two-sided or two-surfaced access should not be required for access to equipment interfaces and hardpoints. The term two-sided infers top/bottom, left/right, front/back, or combinations thereof.
		A-18	Structural design should provide good access to corrosion-prone areas for inspection and treatment.
		AA&S-01	Use transparent windows, quick-opening covers, or openings without any cover to permit quick visual inspections where needed.
		AA&S-02	Flush mounted antennas, sensors, and air data devices should have a good color contrast to surrounding structure when located in walkway areas.
		AA&S-03	Closure and sealing of cavities, compartments, and wells for retractable antennas should be mechanized to function as part of the extend and retract cycle.
		AA&S-04	Closure and sealing of cavities, compartments, and wells for retractable antennas should be maintained when antennas are not installed without need for ancillary measures or equipment.
		AA&S-05	LO antennas should be designed to be tolerant of accumulations of grime or dirt without degrading performance or biasing the BIT/fault isolate performance.
		AA&S-06	Multi-function antennas, arrays, and sensors located in leading edges should be modularized to reduce vehicle downtime through simplified replacement of a faulty module.
		ARM-01	Moveable flaps or slats containing integral antennas, arrays, or sensors should be interchangeable to provide the option for on-vehicle or off-vehicle repair.
		ARM-02	For an aircraft, the fuselage lower shear moldline should be no less than 38" above the ground when external weapons only will be carried on the fuselage.
		ARM-03	For an aircraft, the fuselage lower shear moldline should be no less than 50" above the ground when internal weapons will be carried in the fuselage and weapon bay door widths exceed 22".
		ARM-04	Locate fuselage weapon bays a minimum of 18" from the nose landing gear and main landing gear of an aircraft.
		ARM-05	No single weapon/store mounted on a transporter should intrude into the service/tumaround envelope of another station.
		ARM-06	All servicing and tumaround functions (including movement envelopes) should be outside the gun firing envelope. The relationship of the nose landing gear to the main landing gear should not restrict the positioning of weapon transporters under the fuselage of an aircraft.

Guidelines by Category (Cont'd)

Category No.	Category Title	Guideline No.	Guideline
3.03.06	Structures, Airframes, Bodies, Chassis, and Hulls	ARM-10	Weapon and store stations should be located to ensure vehicle ballasting will not be required under any combination of weapon/store configurations.
		BIT-05	Incorporate testability design features as an integral part of equipment preliminary design process.
		BIT-06	Mission critical functions should be monitored by BIT.
		BIT-09	Use concurrent BIT to monitor system critical functions.
		BIT-26	Locate routinely used test points so they are accessible without removing or disassembling other equipment
		BIT/BITE-02	Design EMI protection to eliminate finger type EMI contact devices.
		C-01	Avoid swivel type connectors and fittings for air, fuel, or hydraulic line interfaces due to their history of low reliability.
		C-02	Provide spacing between parallel plumbing runs so that in-line couplings can be replaced without removing lines or disconnecting any line support devices.
		CARGO-01	Ground vehicles with storage bays or compartments accessible from outside the vehicle should: <ul style="list-style-type: none"> - Have the door sill located no lower than knee height to accommodate a wide range of percentiles while standing. - Ensure door handles are flush with outer surface to protect personnel. - Contain goose neck hinges to protect the hinge from the elements. - Contain peripheral door seals that will protect against blowing sand entry at 50 mph. - Ensure door can be opened with transport tie downs installed. - Ensure door opening envelope does not intrude into the opening envelope of an adjacent door. - Contain simple sheet metal hold-open spring or mechanism. - Ensure floor of bay or compartment is flush with sill to simplify cleanup and drainage. - Ensure door unlocking and opening mechanism can be actuated by a 95 percentile male hand while wearing arctic gloves. - Contain 15 percent added volume for density growth.
		CARGO-02	Ground vehicles with small exterior storage bays or compartments containing emergency equipment or supplies should: <ul style="list-style-type: none"> - Be located at chest height of the 50 percentile male. - Contain unlatching mechanisms activated by pushing inward on the door. - Meet all other generic bay and compartment requirements.
		CBR-01	Orient all vehicle liquid servicing fittings to ensure fluids will not come in contact with protective garb during connect/disconnect activities.
		CBR-02	Ensure vehicle overboard passive liquid drains are clearly marked or visible to enable personnel to remain clear of area.
		CBR-03	Design fuel cell drains so they can not be activated in a manner that would allow fuel to come in contact with a protected hand.
		CBR-04	Design emergency ingress provisions so they can be activated by a 95 percentile male wearing full protective chemical or biological protection gear.
		CBR-05	Size rescue doors, panels, and "cut here" areas to accommodate the 95 percentile shoulder width wearing full protective chemical or biological protection gear.
		CBR-06	Consider the reduction in peripheral vision resulting from wearing chemical or biological protection gear when designing intended fire paths and crash rescue paths into a vehicle.
		CREW-01	Canopy attachment/hinge hardpoints should be located on the same structural subassembly as the canopy locking hardpoints.
		CREW-02	Armor protection integrated with the vehicle structure should be given preference over parasitic armor.
		CREW-03	In rare cases where armor is parasitic, armor should be interchangeable and easily installed.
		CREW-04	Avoid wiring, coax, and plumbing penetrations through the floor of crew cabs, operators' compartments, crew stations, cockpits, and passenger compartments.
		CREW-05	Structural instrument panels, dashboards, and control panels should be modularized for easy and adequate access to all interfaces, to simplify manufacturing, and to reduce maintenance-induced problems.
		CREW-06	Film magazines, tapes, and removable modules should permit considerable handling without reliance on special support equipment protection.

Guidelines by Category (Cont'd)

Category No.	Category Title	Guideline No.	Guideline
3.03.06	Structures, Airframes, Bodies, Chassis, and Hulls	CREW-07	Electronic and photosensitive storage media should withstand the adverse environment created by ground, flightline, or shipboard electromagnetic fields and light sources.
		CREW-08	Data storage media containers and modules should be capable of chemical and biological decontamination processes.
		CREW-09	Crew and operator station cassettes or magazines should be capable of being removed and installed with one hand while the operator or air crew is seated and strapped in.
		CREW-10	Design cameras, recorders, and sensors to be fully interchangeable and quickly replaceable.
		CREW-11	Design cameras, lenses, reconnaissance pods, aiming devices, and related equipment so they can be reconfigured by one individual.
		CREW-12	Requirements for boresighting should not be part of the design or integration.
		CREW-13	Provide storage provisions in each vehicle type (ground and airborne) to store extra tapes, modules, canisters, cassettes, as appropriate to the intended vehicle use/mission.
		D&V-01	The geometric aspects of structural design and interfaces should not result in any natural bathtubs.
		D&V-02	Closed structural sections subject to condensation or fluid migration should contain drainage provisions.
		D&V-03	Crew cabs, operators' compartments, crew stations, cockpits, and passenger compartments should be subject to the same corrosion prevention measures as the exteriors of the vehicles. Low points, pockets, and related fluid collection points within should be provided with low point drains.
		ECS-01	Design so that equipment servicing status are accessible and readable from the ground level for air vehicles and from the operator's position for ground and water vehicles.
		ECS-02	Do not locate equipment servicing points in crew, passenger, or operator areas.
		ECS-03	Heat exchangers using hot liquids as the heat source should not be located inside the compartments used for operator, crew, or passengers.
		ECS-04	Plumbing, lines, or hoses containing hot liquids, toxic gases or liquids should be external to operator, crew, or passenger stations.
		ECS-05	Access, removal, and installation of all type filter elements should be possible without removing the assembly or disconnecting any filter package interfaces.
		ECS-11	Design air inlets, outlets, and exhausts to be accessible without reliance on ladders or work stands for ease of installing protective plugs or covers.
		ECS-12	Design air inlets, outlets, and exhausts with screens to prevent bird or rodent entry.
		ECS-13	Design air inlets, outlets, and exhausts to be meniscus-free to prevent a bathtub effect. In remote instances where this is not possible, passive drains should be provided at all low points to prevent liquid accumulation with the vehicle in its normal static attitude.
		ECS-14	Instances where air inlets, outlets, and exhausts are subject to water entry, passive drains should be employed capable of handling 4" of rain per hour.
		ECS-15	Locate and orient air inlets, outlets, and exhausts in a manner that prevents their use as footholds during maintenance.
		ECS-16	All components contained in the systems, including all attaching brackets and supports, should use hex-head self-locking bolts for ease and simplicity of installation.
		ECS-17	Do not use air ejectors due to their low reliability and susceptibility to clogging.
		ECS-21	Do not locate ground cooling or circulation fans that operate at high noise levels in operator, crew, or passenger compartments.
		ENG(G)-01	Provide access to all engine mounts for ground vehicles so that hoisting or crawling under the vehicle is not required.
		ENG(G)-02	Use torque-limiting bolts or torque washers as engine mount attaching hardware to eliminate the need for torque wrenches.
		ENG(G)-03	Design hard points for hoisting or positioning the engine during installation and removal to be integral to the engine and capable of hoisting and supporting a fully-built-up engine package.
		ENG(G)-04	Do not use downward engine removal concepts that require jacking or hoisting of the ground vehicle.

Guidelines by Category (Cont'd)

Category No.	Category Title	Guideline No.	Guideline
3.03.06	Structures, Airframes, Bodies, Chassis, and Hulls	ENG(G)-05	Use concepts for removing ground vehicle engines from the front, rear, or side rather than from overhead (using hoisting).
		ENG(G)-06	The distance between the engine and firewall should ensure the access envelopes to lines, fittings, wiring, and adjustments will accommodate the 75 percentile male hand.
		ENG(G)-07	The distance between the cooling fan and radiator core should ensure that access envelopes will not require removal of the core.
		ENG(G)-08	The interface of the engine assembly to the engine compartment and structure should be designed to ensure all spark plugs, glo-plugs, and igniters can be replaced within 30 minutes elapsed time.
		ENG(G)-10	Design attaching hardware for all mechanical engine-to-vehicle interfaces to be captive and with integral safeties.
		ENG(G)-16	Do not locate batteries in the engine compartment. In those instances where this is not possible: <ul style="list-style-type: none"> - The battery support structure should be of a material that is impervious to acid leakage or boil-over. - The battery support structure should serve as a scupper to collect and direct the acid out of the engine compartment.
		ENG(G)-18	Incorporate appropriate sensors to enhance the diagnostic and prognostic capabilities for the following: <ul style="list-style-type: none"> - Oil temperature - Oil pressure - Oil filter bypass - Oil cooler bypass valve position - Oil level - Oil return line particle count
		ENG(G)-19	Paint engine compartments gloss white to enhance light reflectivity and enhance fluid leak detection.
		ENG(G)-20	Design all firewall fittings, connectors, and penetrations to be fully viewable and directly accessible to the maintainers.
		ENG-09	On multi-engine air vehicles, the engines should be capable of being installed in any engine cavity without need for reconfiguration.
		ENG-10	On multi-engine air vehicles, the airframe-to-engine interfaces should be in identical positions or orientations for each engine cavity.
		ENG-12	All engine-mounted accessories must be capable of being removed and installed through the available airframe access openings.
		ENG-15	Engine removal for aircraft intended to be operated off carriers should be accomplished within the shadow of the aircraft.
		ENG-16	Aircraft jacking should not be required for engine removal.
		ENG-17	Aft engine removal should be an acceptable alternative for USAF aircraft.
		ENG-18	For either downward or aft engine removal, it should be possible to maintain control of the engine on all axis during the entire removal and installation process.
		ENG-19	The minimum clearance between engine and airframe should be 1 inch, including removal and installation.
		ENG-20	Do not locate equipment or components in the engine cavity except for those components associated with the engine or engine installation.
		ENG-21	Do not locate equipment or components in the engine bay cavity in a manner that would require removal or repositioning for engine removal.
		ENG-22	The engine cavity structure should be capable of withstanding a 2000-degree Fahrenheit fire for 10 minutes without jeopardizing loss of the vehicle.
		ENG-23	All engine borescope provisions should be accessible with the engine installed and hooked up.
		ENG-24	Replacement of all ignitors should be possible with the engine installed.
		ENG-25	All engine-to-airframe plumbing, wiring, and duct interfaces should be capable of being connected or disconnected by hand, should contain integral safety provisions, and should not require torquing.
		ENG-26	Locate and position engine overheat and fire warning sensors so that damage cannot occur during engine maintenance or replacement.

Guidelines by Category (Cont'd)

Category No.	Category Title	Guideline No.	Guideline
3.03.06	Structures, Airframes, Bodies, Chassis, and Hulls	ENG-30	It should not be necessary to close or reinstall engine access doors for engine ground operation up to and including military power.
		ENG-33	Engine access doors and panels and their integral support struts should be capable of withstanding 60 MPH winds in the opened position.
		ENG-34	Identification plates on the engine and all engine-mounted components should be viewable with the engine installed and engine access doors opened.
		ENG-42	Attach engine-to-inlet duct interface seals to the vehicle so they can be left in place during engine removal.
		ENG-43	Design engine-to-inlet duct seal so the interface is automatic during engine installation without needing any form of alignment, adjustment, or mechanical attachment interface.
		ENG-44	Select engine-to-inlet duct seal material to ensure seal life is sufficient for the life of the vehicle.
		ENG-45	Provide remote servicing points accessible from the ground to service engine accessories mounted on top of the engine (e.g., oil tanks, gear boxes, generators, etc.) to eliminate climbing upon or atop the host vehicle.
		ENG-47	Design the engine, including all accessories, plumbing, wiring, ducts, and mechanisms, to meet the same environmental protection and compatibility requirements as the host vehicle.
		ENG-48	Do not drain or dump residual fuel in the engine fuel control/manifold overboard. When it is not possible to follow this guideline, route the fuel to an engine-mounted collector tank capable of retaining fuel from two shutdowns.
		ENV-01	Materials, treatments, coatings, finishes should be compatible with all anti-ice and de-ice fluids, chemical and biological decontamination fluids, washing and cleaning fluids, and all vehicle subsystem fluids.
		ENV-02	There should be no top coat or treatment deterioration throughout the standard temperature and humidity spectrum.
		ENV-03	For airborne vehicles, the finishes should be durable against rain, hail, and dynamic erosion throughout the flight envelope.
		ENV-04	For airborne and ground vehicles, the finishes should be durable against sand erosion throughout all surface wind speeds experienced in arid or desert geographical locations.
		ENV-05	For airborne vehicles, materials and all finishes with the engine inlet should be durable against hammer shock and compressor stalls.
		ENV-06	For ground vehicles, the finishes should be compatible with and durable against all rain, hail, sleet, snow, and ice conditions experienced in all intended operational environments.
		EXH-01	Treatments required for engine hot sections and exhaust areas should not require scheduled removals for the purposes of recoating.
		EXH-02	High temperature exhaust patterns should flow away from or be directed away from treated surrounding structure, coatings, or finishes.
		EXT-01	Locate Tanks, Pods, Containers, and Devices (TPCD's) so they do not block or restrict access to existing vehicle access areas or access approach envelopes.
		EXT-02	Design TPCD's for fuel containment to automatically interface to the host vehicle during installation or removal.
		EXT-03	Design TPCD's to be fully compatible with the existing vehicle built-in hoisting provisions and locking devices.
		EXT-05	Design access doors for cargo type TPCD's to be non-load carrying and with simple latches for all doors and panels.
		EXT-06	Design cargo TPCD's to ensure all cargo and equipment can be downloaded and uploaded with the TPCD installed on the host vehicle.
		EXTING-01	Use extinguishing concepts dedicated to each individual fire zone in preference to manifold systems operating from a central source.
		EXTING-03	Keep each individual fire zone over-temperature/fire warning system separate from those in other fire zones.
		EXTING-04	Design individual fire zone over-temperature/fire warning system to be fully BIT capable (the BIT concept should permit both initiated and periodic BIT).
		EXTING-06	Provide an alternate capability to activate the system remotely from the cockpit/crew station, or operator's position to satisfy emergency situations during vehicle maintenance.

Guidelines by Category (Cont'd)

Category No.	Category Title	Guideline No.	Guideline
3.03.06	Structures, Airframes, Bodies, Chassis, and Hulls		Analyze the vehicle operational environment and type of fire zones to determine if remote stop/shut-off of equipment is warranted.
		EXTING-07	Analyze the vehicle operational environment and type of fire zones to determine if remote alarm and/or visual indication of a fire is warranted.
		EXTING-08	Do not locate provisions for overboard venting or dumping of extinguishing agents in areas that could create hazards for personnel.
		EXTING-09	Use blind fasteners only where absolutely necessary or where considerable cost can be saved.
		F-01	Minimize access fasteners while making them quick release, easily removed and replaced, and captive.
		F-02	Choose fasteners based on the requirement to operate by hand or with common hand tools rather than special tools.
		F-03	Whenever possible, incorporate barrel type fasteners as opposed to hi-torque fasteners. Failure of Hi-torque fasteners due to stripping are common and a source of potential foreign object damage (FOD).
		F-04	Locate fuel vent and dump masts to ensure exiting fuel will be clear of servicing, loading, arming and safing areas for all types of ground and airborne vehicles.
		FUEL-01	Manufacturing splices for major sub-assemblies should not intrude into or through integral fuel cells or tanks.
		FUEL-02	Structural bolts, screws, and fasteners should not penetrate into integral fuel cells or tanks other than those used for access door attachment.
		FUEL-03	Where the fuel wetted area inside a fuel cell or tank is void of blade, knife, and hat stiffeners for use as hardpoint attachment, standoffs bonded to the cell surface should be used as attachments for clamps, and brackets to eliminate fastener penetration of the fuel cavity.
		FUEL-04	Intersecting of two or more surfaces in a fuel wetted area of less than 90 degrees should be avoided to simplify manufacture and repair.
		FUEL-05	Where maintaining a minimum angle of 90 degrees is not possible, sufficient depth, width, and height should be maintained to provide tool clearances for all tools used in the manufacturing processes and in the operational field repair environment.
		FUEL-06	When feed tanks are designed such that the lower portion of the tank serves as a surge chamber, the top closure deck of the surge chamber should provide the strength to support the weight of a 95 percentile male.
		FUEL-07	The size and number of fuel cell and tank access doors should be sufficient to ensure no wetted area of the cell or tank is beyond a maximum 18" distance from the edge of the access opening. This guideline applies to only non-man rated cells.
		FUEL-08	All fuel cell or tank access doors not mounted on the exterior surface should contain sealing provisions other than the channel type.
		FUEL-09	Provide access from the wing closure ribs in lieu of the moldline when access is required in close proximity to the wing fold area.
		FUEL-10	Through-the-tank fasteners should not be used for fuel cells or tanks in areas where a leak path could be established into an inaccessible portion of the vehicle.
		FUEL-11	Avoid the need to remove the tail hook to facilitate engine access or removal.
		HOOK-06	For military combat vehicles having two or more hydraulic power systems, provide a minimum 30-inch spacing between ground power and servicing interfaces to ensure:
		HYD-01	- Design flexibility in locating and arranging equipment in high-density vehicles such as fighters and helicopters, - Work area separation to enable concurrent service/maintenance on systems, - Systems vulnerability enhancement, - Reduction in turn-around elapsed time due to concurrent servicing capability.
		IN(V)-01	Design inlet door actuators and door actuation mechanisms so they not protrude into the air inlet flow field to eliminate FOD potential.
		IN(V)-02	Do not use loose structural fasteners in the access area to inlet door actuators and mechanisms. Where this guideline cannot be followed, design the actuator door to be accessible only when the inlet doors are fully closed.
		IN(V)-03	For engine inlet bellmouth fairings, use methods of retention other than fasteners. Latches may be considered as an acceptable alternative only if latch-to-panel retention is from the inner mold line.

Guidelines by Category (Cont'd)

Category No.	Category Title	Guideline No.	Guideline
3.03.06	Structures, Airframes, Bodies, Chassis, and Hulls		
		IN(V)-04	Design inlet doors and inlet bellmouth fairings to be fully interchangeable to eliminate the need to cut, file, or trim at the engine face.
		IN(V)-05	Locate the inlet duct edge a minimum of 60 inches from the cockpit or crew station to eliminate restricting engine operation to canopy-closed conditions.
		IN(V)-06	Use captive fasteners on all access doors forward of the inlet to significantly reduce engine FOD potential.
		IN(V)-07	Ensure that no ground safety pins or streamers are used forward of the inlet or within a 3-foot radius aft of the inlet.
		IN(V)-08	Incorporate an inlet closure door sealing concept that prevents entry of fluid, dust, or sand across the entire airborne and ground environment spectrum.
		IN-01	Low Observable (LO) engine face frames should be within 10 inches of the first stage fan or compressor blades.
		IN-02	Openings throughout the engine face frame should be sufficient to perform a 100% FOD inspection of the engine face.
		IN-03	Openings throughout the engine face frame should be sufficient to permit minor blending or repair of FOD without removing the engine.
		IN-04	For frames not integral with the engine, frame removal should be achievable from the engine cavity.
		IN-05	Both integral and remote engine front frames should be interchangeable.
		IN-06	Front frame anti-ice and de-ice provisions should give preference to engine hot bleed air.
		LG-02	Hardpoints for attachment of landing gear trunnions should be capable of carrying all induced gear loads for the life of the airframe.
		LG-03	Hardpoints for attachment for landing gear trunnions should not be machined as an integral part of the airframe structure when normal design sink rates over 25 feet per second are required.
		LG-04	Do not use Beryllium and Beryllium base alloys in any location subject to wear or corrosive atmospheres or in installations where machining may be required.
		LG-06	Design struts, attachments, and interfaces so they do not depend on scheduled visual inspections, non-destructive inspection (NDI), or non-destructive test (NDT) to ensure the reliability or integrity of the system in the operational environment.
		LG-09	Use coiled tubing in lieu of flex lines or hoses for hydraulic line routing from the airframe to the strut.
		LG-14	All interfaces from the airframe to the struts should be visible and accessible, and not require removal of airframe structure for access.
		LG-15	No portion of the landing gear closure door(s) should be attached to the strut. In rare instances where this may not be possible, that attached portion should not require alignment or rigging.
		LG-16	No portion of the landing gear rigging process should require support equipment type templates, gauges, or tools. Indexes, reference points, etc., should be an integral part of the landing gear/airframe design.
		LG-17	Hydraulic, pneumatic, or electrical actuators associated with landing gear systems should not require adjustment or rigging once installed in the air vehicle. Spare units should be rigged at the time of manufacture or overhaul.
		LG-25	Mechanical shrink struts, when used, should not permit gear to jam in wheel well if failure of shrink mechanism occurs.
		LG-26	Gravitational emergency extension of landing gear should be given preference over all other concepts.
		LG-30	Do not use landing gear wells to locate any type of auxiliary air inlet.
		LG-31	Landing gear doors designed to close after gear is extended should be capable of being manually opened on the ground without reliance on electrical or hydraulic power.
		LG-32	Design of landing gear doors normally closed after gear extension should ensure failure modes will not enable uncommanded opening on the ground.
		LG-33	Design of landing gear doors normally left open after gear extension should ensure no failure mode will enable closing on the ground.
		LG-34	Avoid sharp edges and corners on landing gear doors or fairings.
		LG-35	Avoid the use of landing gear doors to mount or house antennas, arrays, or air data sensors.
		LG-36	Location of integral wheel jack points on a strut should provide a minimum 6-1/2 inch clearance for positioning the jack with tire ruptured and wheel ground 2 inches off ground.

MIL-HDBK-470A

APPENDIX C

Guidelines by Category (Cont'd)

Category No.	Category Title	Guideline No.	Guideline
3.03.06	Structures, Airframes, Bodies, Chassis, and Hulls	LG-37	Integral hardpoints to jack the entire vehicle should ensure that identical jacks can be used at all jack points.
		LG-38	All landing gear doors should be interchangeable.
		LG-39	Gear-mounted tie-down or chain-down fittings should be interchangeable and easily replaceable.
		LG-41	No more than 1 jack should be required to change any singular wheel/tire assembly.
		LG-44	Landing gear door mechanisms and interfaces should ensure that multiple cycles or occasional exceedence of maximum gear-down speed do not result in loss of doors
		LO-01	Use LO compatible gap fillers for manufactured gaps in lieu of tape and butter (surface coating compound).
		LO-02	Avoid scheduled forced inspections or replacement of materials, coatings, or finishes solely to protect either the reliability or the signature.
		LO-03	Equipment and support structure requiring shrouds to reduce radar returns should not cause increases in equipment service/repair time.
		LO-04	Infrequently-accessed structural doors and panels incorporating special coatings or conductive paints should contain provisions for prying the door or panel clear of moldline with standard screwdriver without damage.
		LO-05	Do not locate flush mounted LO screens for auxiliary air inlets and exits in walkway areas unless durability has been proven.
		LO-06	Size flush mounted LO screens for auxiliary air inlets and exits to ensure functionality with up to 25 percent of the openings plugged.
		LO-07	Flush and non-flush LO screens should be interchangeable.
		MATL-01	A high degree of durability should be maintained for a minimum distance of 36 inches forward of the inflight refueling receptacle.
		MATL-02	Cosmetic type repairs should not exceed 1 hour including cure or drying times.
		MATL-03	Cosmetic and vehicle repair material shelf life should not be less than 24 months.
		MATL-04	Cosmetic and vehicle repair materials should be non-proprietary and non-single source.
		MATL-05	Cosmetic and vehicle repair materials should not require refrigeration or special facilities or atmospheres for storage.
		MATL-06	Repair criteria, repairs, and instructions should not be classified.
		MATL-07	All cosmetic touch-up and repair materials should be environmentally safe.
		MATL-08	Repairs (other than major depot repair) should not require autoclave type facilities.
		MATL-09	A high degree of durability should be achieved across all walkway areas on the top surfaces of all vehicles up to and including 95 percentile personnel.
		MATL-10	Coatings and finishes should be durable against the effects of missile gases, velocities, and particles emanating from the missile motor.
		MATL-11	Coatings and finishes should be durable against the effects of gun gases, projectile shock waves, and brass particles emanating from the projectile seal rings.
		MATL-12	Leading edge materials and coatings should be durable against fragments from frangible gun port plugs.
		MATL-13	Special handling or shipping requirements of repair materials should be avoided.
		MATL-14	Leading edges, including chines, containing or constructed of radar absorbing materials, should be interchangeable to reduce vehicle downtime and simplify repairs.
		MATL-15	Doors and panels containing blade seals used for signature reduction should be interchangeable or contain interchangeable blade seals. Deviation is acceptable where repairs can be accomplished on the vehicle in a time equal to or less than door or seal remove and replace time.
		MC-01	All clamps should contain torque-set or torque-limiting connections to prevent clamp or component failure due to over-torque. Clamp installation call outs should not depend on special tools to establish the required torque values.
		MC-02	Avoid the use of cotter pins, safety wire, safety clips, and similar devices to prevent maintenance-induced events leading to ground vehicle accidents or loss of air vehicles.

Guidelines by Category (Cont'd)

Category No.	Category Title	Guideline No.	Guideline
3.03.06	Structures, Airframes, Bodies, Chassis, and Hulls	MC-03	All tubing connections and interfaces should use rosan/dynatube (or equivalent) to (1) enable connect or disconnect with one hand, one tool, (2) eliminate the need to safety the connection, (3) provide a superior seal, and (4) negate need to reposition line(s) during component replacement.
		MC-04	No trombone type, flared tube type, or piloted line type interfaces should be used to avoid the need for removal or repositioning during equipment removal.
		MC-05	Avoid potential foreign object traps during manufacturing or operational maintenance by eliminating vertical penetrations of plumbing/fittings into tanks, compartments, or cells
		MC-06	Locate, position, orient all plumbing and duct electrical connectors to prevent the need for sequential installation or removal.
		MC-07	Maximize areas of constant web thickness in firewalls, carry-through bulkheads, major frames, structural ribs, spars, webs, keels, and close-outs to provide flexibility in locating penetration fittings. Stepped chem milling, stepped machining, stepped composite layup concepts all tend to result in minimal available surface area for penetrations.
		MC-08	All in-line plumbing connections within a fuel tank or cell should be capable of making/breaking the interface by hand, require no torque, contain integral safety locking mechanisms, and should be void of any requirement for safety wire.
		MC-09	All plumbing connections and fittings used for fuel systems should contain integral bonding features to eliminate the need for bonding clamps or jumper cables.
		MC-10	In rare instances where a plumbing run contains complex form or geometry that would require removal of other plumbing or equipment for access, in-line connectors should be incorporated to maintain the integrity of other plumbing or equipment.
		MC-12	All plumbing and connectors containing liquids should be meniscus-free.
		MC-13	In instances where plumbing or connector interfaces cannot or are not keyed for a specific orientation, all identification, markings, cautions, and directions should be placed 360 degrees around the tube or duct.
		MC-14	Where multiple connectors are located in close proximity, ensure (1) a minimum hand tool arc of 120 degrees can be maintained, and (2) stagger fittings to ensure firm coupling interface/hand tool interface can be accomplished without inducing damage to adjacent lines.
		MC-15	Route, orient, and position plumbing, wiring, ducts, and connectors sufficiently away from the outer surface of the vehicle to preclude induced damage due to minor dents, drill bits during repair, etc. Minimum rule of thumb is 1" away from the inner surface and 1" below a plate nut channel.
		MG-01	Mount LRUs/sub-systems on drawer slides or extender racks to provide easier accessibility during integration, testing, debug, and repair of Units Under Test (UUTs).
		OXY-05	Locate liquid oxygen (LOX) containers in a sealed, dedicated compartment to eliminate need for frequent visual inspections.
		OXY-07	Locate liquid oxygen containers to ensure simultaneous replacement with other turnaround activities.
		OXY-12	LOX compartments should be sealed from adjacent compartments and should contain dedicated overboard drains.
		P-01	Access door and panel fastener types for airborne vehicles should meet the following criteria: <ul style="list-style-type: none"> - use latches for a frequency of access of 0 to 40 flight hours - use High Strength Quick Release fasteners for a frequency of access of 40-400 flight hours - use structural screws for a frequency of access of 400 flight hours or more
		P-02	Access door and panel fastener types for surface vehicles should meet the following criteria: <ul style="list-style-type: none"> - use a spring loaded or latch fastener for an opening frequency of daily - use a one quarter turn fastener (or equivalent) for an opening frequency of weekly - use screws or bolts for all other cases
		P-03	All doors and panels subject to environmental elements should contain form-in-place seals (or equivalent) attached to the door structure, not substructure, to prevent damage during maintenance.
		P-04	Door and panel seals should be compatible with all types of on-board servicing fluids, de-ice and anti-ice fluids, and all fluids used for chemical, biological, and nuclear decontamination.

MIL-HDBK-470A

APPENDIX C

Guidelines by Category (Cont'd)

Category No.	Category Title	Guideline No.	Guideline
3.03.06	Structures, Airframes, Bodies, Chassis, and Hulls		
		P-05	Piano type hinges should not be used on doors or panels because they are subject to wear, corrosion, and sand and fluid entry.
		P-06	Access door and panel devices used to support door in opened position should meet the following criteria: - for airborne vehicles, design for 60 knot gust loads (or equivalent jet blast loads) - for ground vehicles, design for 50 mph gust loads
		P-07	Hinged access doors and panels capable of remaining in the opened position should not have sharp edges or corners.
		P-08	Removable access door and panel fasteners should be of identical grip length and diameter.
		P-09	Acceptable door and panel hold-open devices include over-center sheet metal spring, over-center spring link, spring cartridge, support strut, and pinned goose neck hinge.
		P-10	Access doors and panels requiring non-captive fasteners should not be located forward of air inlet ducts or high-energy rotating components (e.g., prop fans, engine cooling fans, etc.).
		P-11	Access doors and panels should be interchangeable as justified by operation and support costs or life cycle costs.
		PERS-01	Group man-machine interfaces manifold-style to enable connect/disconnect in a single action.
		PERS-02	Include an integral, highly visible indicator in a man-machine interface connector to denote connector is seated and locked.
		PERS-03	Design interface connectors so that a distinct action is required by an individual to effect a disconnect. (Excludes airframe-to-ejection seat personnel interfaces.)
		PERS-04	Interfaces should contain an emergency release mechanism that can be activated by rescue personnel with a 95 percentile gloved hand.
		PERS-05	Design emergency interface release mechanisms to be clearly visible under all types of lighting situations.
		PERS-06	Storage bins, compartments, sacks, or bags should be available within the vehicle to store/protect all personal equipment required to conduct operations.
		PERS-07	All flight and ground vehicles should contain one cubic foot minimum storage compartment(s) for various loose and sundry personal items (for each individual).
		PERS-08	Design stowage and mounting provisions for portable air or oxygen containers to withstand 40G crash or impact loads.
		PYRO-07	Manual "safe/arm" mechanisms should be well-clear of inlet ducts, propellers, rotors, and similar rotating components.
		PYRO-08	Manual "safe/arm" mechanisms should be well-clear of engine exhausts, fuel/toxic vents, fluid drains, control surface deflection envelopes, and rescue path envelopes.
		PYRO-20	Weapon bay doors, when opened, should not block or restrict access to other servicing points.
		PYRO-26	Do not locate ammunition loader interfaces close to inlets, exhausts, fuel dumps and drains, antennas, sensors, lights, or hazardous protrusions.
		PYRO-27	Incorporate integral hoisting provisions at each weapon/store station to enable direct lift from the container or carrier to the attachment hardpoints.
		PYRO-28	Automatic locking of the retention hooks should be accomplished for each respective weapon and store.
		PYRO-29	Provide quick mechanical over-travel (no power) for weapon bay doors to maximize the weapon/store loading envelope.
		PYRO-30	Ensure weapon bay door arc (both normal and over-travel) does not block or intrude into adjacent service points or envelopes.
		PYRO-32	Provide sufficient longitudinal clearance between weapon bays to enable simultaneous loading of two bays.
		PYRO-33	Provide sufficient lateral clearance between weapon bays to enable simultaneous loading of two bays.
		PYRO-34	Weapon bay door seals should be bonded or attached to door structure to minimize induced seal damage during weapon or store loading.
		PYRO-35	Suspension system should permit any single weapon or store to be loaded by a two man crew.
		PYRO-36	Suspension system design and spacing should enable any combination of eight weapons to be loaded by two two-man crews within the refueling time of the vehicle (excludes nuclear weapons).
		PYRO-37	Internal weapon suspension arrangements should preclude sequential weapon loading.
		PYRO-39	Weapon bay ejectors and launchers should have the capability for total interchangeability and reconfigurability.

MIL-HDBK-470A

APPENDIX C

Guidelines by Category (Cont'd)

Category No.	Category Title	Guideline No.	Guideline
3.03.06	Structures, Airframes, Bodies, Chassis, and Hulls		
		PYRO-43	Launcher or ejector design/interface should not require a dual function of carrying airframe structural loads.
		PYRO-46	Design pylons, launchers, and ejector racks so that weapon loading, servicing, and reconfigurations can be accomplished using standard hand tools.
		PYRO-47	Installation design of ejectors, launchers, racks, and associated hardware interfaces should avoid reliance on torque wrenches.
		R-01	Large radomes wherein the combination of the diameter and length exceeds 60" should be top-hinged. Hinge should be load-carrying to reduce radome retention fastener count.
		R-02	Radome and radar array support structure design and material selection should eliminate the need for LO type fillers or shrouds.
		SABCH-01	Do not locate auxiliary air inlets, sensors, access doors, or drains in boundary bleed areas.
		SABCH-02	All flush type structural screws should have identical head drives for the entire vehicle.
		SABCH-03	All non-flush type structural screws should have identical head drive recesses for the entire vehicle.
		SABCH-04	Special high strength bolts, such as twelve-point heads, should be fully justified from standpoint of the cost of ownership and effectiveness.
		SABCH-05	Structural design should avoid the reliance on blind fasteners unless fully supported by cost, weight, schedule, and effectiveness analysis.
		SABCH-06	Structural design should avoid the potential of dissimilar material or fastener corrosion.
		SABCH-07	No structural fasteners should be used that require special tools for installation.
		SABCH-08	Taper pins should be threaded and retained with self-locking hardware.
		SABCH-09	Pins and collars (lockbolts) should only be used in applications which do not normally require removal.
		SABCH-10	Do not use lockbolts in composites.
		SABCH-11	In rare instances where the use of dissimilar material in immediate contact cannot be avoided, they should be sufficiently insulated to endure for the life of the vehicle.
		SABCH-12	Avoid tapping threads into structural members. Use of heli-coil type or similar insert concepts is permissible.
		SABCH-13	No structural design concept should rely on frequent scheduled inspections to monitor or otherwise ensure structural integrity.
		SABCH-14	No structural fastener intended to carry shear or tension loads should be smaller than 1/4" diameter (.25").
		SABCH-15	Give preference to butt type splices over lap type splices in the design of manufacturing splices.
		SABCH-16	Wing-to-fuselage attachment should give preference to tension ties over shear ties to improve overall volumetric efficiency.
		SABCH-17	Hardpoints for securing tie down chains, cables, and devices during transport should not require reaching under or crawling under the vehicle.
		SABCH-18	Rings, posts, and clevis devices used for attaching tie downs should not require opening of doors or panels for access.
		SABCH-19	Avoid tie down concepts requiring attaching hardpoints as a prerequisite.
		SABCH-20	Location of hardpoints used for tie down attachment should: <ul style="list-style-type: none"> - Remain outside of door and panel opening envelopes. - Be clear of exhaust pipes, ducts, manifolds, and mufflers. - Be clear of overboard fluid drains and vents.
		SAFE-01	Drag chute installation designs not containing electrical safing should contain remote safe/arm provisions reachable from ground level by 5 percentile females. Remove location should be clear of engine exhaust areas and flight control deflection envelopes.
		SAFE-02	Emergency ingress actuation provisions into cockpits, crew stations, passenger compartments, and operator stations should be accessible from the ground by 5 percentile females.
		SAFE-05	Crash locator beacon door opening/ejection mechanisms should contain integral electrical safe/arm features.

MIL-HDBK-470A

APPENDIX C

Guidelines by Category (Cont'd)

Category No.	Category Title	Guideline No.	Guideline
3.03.06	Structures, Airframes, Bodies, Chassis, and Hulls	SAFE-08	A single lever safety should, when positioned, safe the entire escape/ejection system. Use of the single lever to "arm" should require two hands.
		SAFE-09	Safing the canopy jettison system should be accomplished through the same lever device used to safe the ejection seat.
		SAFE-12	Internal weapon bay doors should contain integral safety locking features for use during maintenance and weapon loading and downloading.
		SAFE-13	It should not be possible to unsafe a weapon bay door integral lock when a door closed signal is present.
		SEAT-01	Design personnel seats and padding materials, including the covers and fillers, so they are incapable of creating or emitting toxic fumes or dense smoke when subjected to fire.
		SEAT-02	Design personnel seats and padding materials so they are incapable of absorbing and holding fluids.
		SEAT-04	Design ejection seats so they can be replaced with canopy or escape hatch installed.
		SEAT-05	Design ejection seat pyrotechnic devices so they are 100 percent viewable and accessible with seat installed.
		SEAT-06	Do not use seat removal as a means of access.
		SIMP-01	Location and design of all exterior lights should not require protective covers in ground environments.
		SIMP-02	Landing and taxi lights should be mounted on landing gear struts or doors to eliminate separate compartments, doors, and retraction/extension mechanisms.
		SURV-01	Design containers used for dinghy stowage to be structurally capable of containing the dinghy within the event of unintentional or uncommanded inflation.
		SURV-02	Provide crew stations, crew compartments, and operator areas containing dinghies as emergency equipment with a suitable tool for puncturing or cutting the dinghy in the event of inadvertent inflation. Locate the tool so that access is assured during dinghy inflation.
		T-01	Do not locate pyro, gas, and air (PGA) control system exhaust exits: <ul style="list-style-type: none"> - In proximity to safe, arm, or servicing areas, - Adjacent to auxiliary inlets, - In close proximity to crew boarding areas, weapons, emergency ingress/egress areas, and optics or optical glass.
		T-02	Design pyro type thruster exits associated with emergency use or backup with simple exit closure devices to identify if a thruster has been fired.
		T-03	Provide protective screens for PGA exits that normally remain open to prevent intrusions from fowl or wildlife.
		T-04	Provide protective closure provisions for PGA exits located or oriented to exposure from the elements.
		W-01	Hat section type structural stiffeners with sufficient cross sectional area should be considered as a routing tunnel for wiring and coax.
		WBAY-01	Equipment bays and compartments should not require installation of special cavity fillers when equipment is not installed.
		WBAY-02	Pylon-to-wing electrical or plumbing interfaces should have automatic close-out covers when pylon is jettisoned or not installed.
		WBAY-04	The gap treatment should be a permanent installation on the pylon, wing, or both, not a separate seal.
		WBAY-05	Gap treatment should not interfere with or be damaged by existing pylon handling support equipment.
		WBAY-06	Pylon rigging should not be required for gap seal control.
		WBAY-07	Gap seal should not degrade interchangeability of pylon.
		WBAY-08	Gap seal and treatment should be fully compatible with steam from carrier catapults.
		WBAY-09	Gap seal/pylon should not cover or hamper access to low point wing drains.
		WBAY-10	No loose hardware should exist before or after pylon is installed.
		WBAY-16	Gap seals should not degrade loading while wearing arctic or chemical, biological, or radiation protective clothing.
		WBAY-17	Special coatings or conductive paints on pylons, launchers, racks, launchers, tanks, pods, etc. should have the durability to withstand contact with support stands/cradles during storage.
		WBAY-18	The proximity of the gun firing barrel to structure should be such that structural furrows or channels are not required for projectile clearances during firing.

Guidelines by Category (Cont'd)

Category No.	Category Title	Guideline No.	Guideline
3.03.06	Structures, Airframes, Bodies, Chassis, and Hulls	WBAY-19	Frangible gun ports should take preference over mechanized gun port doors.
		WBAY-20	Gun plugs required solely to maintain a given signature level should be capable of on-board stowage for use only when a threat requires their presence.
		WBAY-21	Coatings and finishes in the area of gun barrels should be durable to withstand the effect of exiting projectile shockwaves.
		WBAY-22	The proximity of the gun blast deflector to structure should not require reliance on high-temperature paints or coatings to protect the structure.
		WIND-01	Optical window materials should be scratch resistant, easy to clean, and dissipate electrostatic charges.
		WIND-02	Optic windows should be located for ease of inspection, cleaning, and induced damage potential from personnel or support equipment.
		WIND-03	Window locations should minimize the effects of contamination by salt spray, bugs, oils, fuels, and icing.
		WIND-04	Window, canopy, and windshield material should be designed to withstand the effects of sandstorms in the ground environment and the effects of rain and hail during thunderstorm penetration in the airborne environment.
		WIND-05	Design interior surfaces to be reachable for cleaning without reliance on hinging, equipment removal, or use of support equipment.
		WIND-06	Do not locate windows in the proximity of rooster tails created by wheels/tires passing through water or slush.
		WIND-11	For dome-shaped optic window concepts, the dome should be easily removable for cleaning without affecting LO integrity.
		WIND-12	Design EO windows and optics to be interchangeable among the same air vehicle types or same ground vehicle types.
		WIND-13	The combination of material layers and coatings for optics and windows should be such that static charge buildup for worst case conditions should not exceed 10,000 volts.
		WIND-14	Exterior lights should permit simple and rapid bulb replacement without disturbing LO treatments.
		WIND-15	Design light covers and lenses to be sufficiently durable so that protective covers are not needed during maintenance.
		WIND-16	Lens shape should enhance LO capability to reduce need, care, and expense for special coatings.
3.03.07	Cargo Holds, Storage Bays, and Storage Compartments	A-01	Seal equipment bays and compartments against the environmental elements including all types of servicing fluids used for the vehicle, all types of anti-ice and de-ice fluids, and all types of fluids used for chemical, biological, or nuclear decontamination
		A-02	Equipment bay and compartment structure should be bonded, co-cured, welded, machined, or combinations thereof to eliminate or minimize the use of mechanical fasteners.
		A-03	All equipment bay and compartment structural flanges and stiffeners should be external to the compartment to maximize the volume available for equipment installation and arrangement.
		A-04	Use stiffening beads in lieu of flanges to the maximum extent to enhance compartment volume and simplify repairs.
		A-05	Stiffening beads should have the convex surface toward the compartment to eliminate fluid traps.
		A-06	Keep all machined compartment frames, webs, and closure panels to a constant thickness (e.g., not stepped or tapered) to ease simplicity of fluid or electrical penetrations and ease and simplicity of structural repair.
		A-07	Hardpoints (structural attachment and load bearing areas) within a compartment to assist in equipment mounting or support should not be integral with the machined part. Hardpoints should be parasitic to enable quick repair in case of wear or damage in lieu of precise ream/bush repair typical of machined hardpoints.
		A-08	Paint equipment bay and compartment interiors a high gloss white to maximize lighting reflectivity, visibility, and rapid leak detection capability.
		A-09	Plumbing penetrations into a compartment should not be on a vertical axis due to difficulty in making or breaking vertically-oriented connections. When compartment access is from the bottom, vertically-oriented connections can allow fluid to leak onto the maintainer. When access is from the top, such connections can allow foreign matter to enter the line. Use horizontal penetrations whenever possible.
		A-09	Any heat or temperature sensitive structure within a compartment should contain heat-sensitive tape or appropriate heat sensor for easy indication of over-temperature excursions.

Guidelines by Category (Cont'd)

Category No.	Category Title	Guideline No.	Guideline
3.03.07	Cargo Holds, Storage Bays, and Storage Compartments	A-10	Provide a sufficient number of compartment fluid drains to ensure fluid drainage for varying aircraft static attitudes and varying terrain slopes for ground vehicles.
		A-11	Locate compartment electrical penetrations close to the access opening for ease of sight, probing, repair, and to eliminate fluid soaking, wicking, or contamination.
		A-12	Locate compartment electrical penetrations far enough from the access opening to prevent damage resulting from improper (over-length) panel fasteners.
		A-13	Two-sided or two-surfaced access should not be required for access to equipment interfaces and handpoints. The term two-sided infers top/bottom, left/right, front/back, or combinations thereof.
		A-15	Locate tie-down attachment points such that tie-down chains, straps, or cables do not prevent or restrict normal servicing, weapon loading, or safe/arm functions.
		A-16	Structural design should provide good access to corrosion-prone areas for inspection and treatment.
		A-18	Use transparent windows, quick-opening covers, or openings without any cover to permit quick visual inspections where needed.
		BIT-06	Mission critical functions should be monitored by BIT.
		BIT-09	Use concurrent BIT to monitor system critical functions.
		BIT/BITE-02	Design EMI protection to eliminate finger type EMI contact devices.
		C-01	Avoid swivel type connectors and fittings for air, fuel, or hydraulic line interfaces due to their history of low reliability.
		C-02	Provide spacing between parallel plumbing runs so that in-line couplings can be replaced without removing lines or disconnecting any line support devices.
		CARGO-01	Ground vehicles with storage bays or compartments accessible from outside the vehicle should: <ul style="list-style-type: none"> - Have the door sill located no lower than knee height to accommodate a wide range of percentiles while standing. - Ensure door handles are flush with outer surface to protect personnel. - Contain goose neck hinges to protect the hinge from the elements. - Contain peripheral door seals that will protect against blowing sand entry at 50 mph. - Ensure door can be opened with transport tie downs installed. - Ensure door opening envelope does not intrude into the opening envelope of an adjacent door. - Contain simple sheet metal hold-open spring or mechanism. - Ensure floor of bay or compartment is flush with sill to simplify cleanout and drainage. - Ensure door unlocking and opening mechanism can be actuated by a 95 percentile male hand while wearing arctic gloves. - Contain 15 percent added volume for density growth.
		CARGO-02	Ground vehicles with small exterior storage bays or compartments containing emergency equipment or supplies should: <ul style="list-style-type: none"> - Be located at chest height of the 50 percentile male. - Contain unlatching mechanisms activated by pushing inward on the door. - Meet all other generic bay and compartment requirements.
		CBR-01	Orient all vehicle liquid servicing fittings to ensure fluids will not come in contact with protective garb during connect/disconnect activities.
		CBR-02	Ensure vehicle overboard passive liquid drains are clearly marked or visible to enable personnel to remain clear of area.
		CBR-05	Size rescue doors, panels, and "cut here" areas to accommodate the 95 percentile shoulder width wearing full protective chemical or biological protection gear.
		D&V-01	The geometric aspects of structural design and interfaces should not result in any natural bathtubs.
		D&V-02	Closed structural sections subject to condensation or fluid migration should contain drainage provisions.
		D&V-03	Crew cabs, operators' compartments, crew stations, cockpits, and passenger compartments should be subject to the same corrosion prevention measures as the exteriors of the vehicles. Low points, pockets, and related fluid collection points within should be provided with low point drains.
		ECS-01	Design so that equipment servicing status are accessible and readable from the ground level for air vehicles and from the operator's position for ground and water vehicles.

Guidelines by Category (Cont'd)

Category No.	Category Title	Guideline No.	Guideline
3.03.07	Cargo Holds, Storage Bays, and Storage Compartments	ECS-02	Do not locate equipment servicing points in crew, passenger, or operator areas.
		ECS-03	Heat exchangers using hot liquids as the heat source should not be located inside the compartments used for operator, crew, or passengers.
		ECS-04	Plumbing, lines, or hoses containing hot liquids, toxic gases or liquids should be external to operator, crew, or passenger stations.
		ECS-05	Access, removal, and installation of all type filter elements should be possible without removing the assembly or disconnecting any filter package interfaces.
		ECS-11	Design air inlets, outlets, and exhausts to be accessible without reliance on ladders or work stands for ease of installing protective plugs or covers.
		ECS-12	Design air inlets, outlets, and exhausts with screens to prevent bird or rodent entry.
		ECS-13	Design air inlets, outlets, and exhausts to be meniscus-free to prevent a bathub effect. In remote instances where this is not possible, passive drains should be provided at all low points to prevent liquid accumulation with the vehicle in its normal static attitude.
		ECS-14	Instances where air inlets, outlets, and exhausts are subject to water entry, passive drains should be employed capable of handling 4" of rain per hour.
		ECS-15	Locate and orient air inlets, outlets, and exhausts in a manner that prevents their use as footholds during maintenance.
		EDECOM-01	Provide surface sensors on equipment located in compartments containing louvers, screens, flush inlets, or similar openings to the environment to indicate the presence of chem/bio contaminants.
		EDECOM-02	Provide integral sensors (viewable from the exterior) for equipment subject to internal forced-air cooling from outside or external air to indicate the presence of contaminants.
		EDECOM-03	Design equipment surfaces and structure to be compatible with all decontamination agents and methods.
		EDECOM-04	Provide passive overboard drains in compartments subject to decontamination processes to void the area of contaminants.
		EDECOM-05	Provide hoist, lift or transport handles for equipment requiring removal from the host vehicle for decontamination. In instances where this may not be practical, design the equipment with hardpoints for attaching parasitic carrying provisions
		ENV-01	Materials, treatments, coatings, finishes should be compatible with all anti-ice and de-ice fluids, chemical and biological decontamination fluids, washing and cleaning fluids, and all vehicle subsystem fluids.
		ENV-02	There should be no top coat or treatment deterioration throughout the standard temperature and humidity spectrum.
		ENV-03	For airborne vehicles, the finishes should be durable against rain, hail, and dynamic erosion throughout the flight envelope.
		ENV-04	For airborne and ground vehicles, the finishes should be durable against sand erosion throughout all surface wind speeds experienced in arid or desert geographical locations.
		ENV-06	For ground vehicles, the finishes should be compatible with and durable against all rain, hail, sleet, snow, and ice conditions experienced in all intended operational environments.
		EXT-01	Locate Tanks, Pods, Containers, and Devices (TPCD's) so they do not block or restrict access to existing vehicle access areas or access approach envelopes.
		EXT-02	Design TPCD's for fuel containment to automatically interface to the host vehicle during installation or removal.
		EXT-03	Design TPCD's to be fully compatible with the existing vehicle built-in hoisting provisions and locking devices.
		EXT-05	Design access doors for cargo type TPCD's to be non-load carrying and with simple latches for all doors and panels.
		EXT-06	Design cargo TPCD's to ensure all cargo and equipment can be downloaded and uploaded with the TPCD installed on the host vehicle.
		EXTING-01	Use extinguishing concepts dedicated to each individual fire zone in preference to manifold systems operating from a central source.
		EXTING-03	Keep each individual fire zone over-temperature/fire warning system separate from those in other fire zones.
		EXTING-04	Design individual fire zone over-temperature/fire warning system to be fully BIT capable (the BIT concept should permit both initiated and periodic BIT).

Guidelines by Category (Cont'd)

Category No.	Category Title	Guideline No.	Guideline
3.03.07	Cargo Holds, Storage Bays, and Storage Compartments	EXTING-06	Provide an alternate capability to activate the system remotely from the cockpit/crew station, or operator's position to satisfy emergency situations during vehicle maintenance.
		EXTING-07	Analyze the vehicle operational environment and type of fire zones to determine if remote stop/shut-off of equipment is warranted.
		EXTING-08	Analyze the vehicle operational environment and type of fire zones to determine if remote alarm and/or visual indication of a fire is warranted.
		EXTING-09	Do not locate provisions for overboard venting or dumping of extinguishing agents in areas that could create hazards for personnel.
		F-01	Use blind fasteners only where absolutely necessary or where considerable cost can be saved.
		F-02	Minimize access fasteners while making them quick release, easily removed and replaced, and captive.
		F-03	Choose fasteners based on the requirement to operate by hand or with common hand tools rather than special tools.
		F-04	Whenever possible, incorporate barrel type fasteners as opposed to hi-torque fasteners. Failure of Hi-torque fasteners due to stripping are common and a source of potential foreign object damage (FOD).
		FUEL-01	Locate fuel vent and dump masts to ensure exiting fuel will be clear of servicing, loading, arming and safing areas for all types of ground and airborne vehicles.
		FUEL-02	Manufacturing splices for major sub-assemblies should not intrude into or through integral fuel cells or tanks.
		FUEL-03	Structural bolts, screws, and fasteners should not penetrate into integral fuel cells or tanks other than those used for access door attachment.
		FUEL-04	Where the fuel wetted area inside a fuel cell or tank is void of blade, knife, and hat stiffeners for use as hardpoint attachment, standoffs bonded to the cell surface should be used as attachments for clamps, and brackets to eliminate fastener penetration of the fuel cavity.
		FUEL-05	Intersecting of two or more surfaces in a fuel wetted area of less than 90 degrees should be avoided to simplify manufacture and repair.
		FUEL-06	Where maintaining a minimum angle of 90 degrees is not possible, sufficient depth, width, and height should be maintained to provide tool clearances for all tools used in the manufacturing processes and in the operational field repair environment.
		FUEL-07	When feed tanks are designed such that the lower portion of the tank serves as a surge chamber, the top closure deck of the surge chamber should provide the strength to support the weight of a 95 percentile male.
		FUEL-08	The size and number of fuel cell and tank access doors should be sufficient to ensure no wetted area of the cell or tank is beyond a maximum 18" distance from the edge of the access opening. This guideline applies to only non-man rated cells.
		FUEL-09	All fuel cell or tank access doors not mounted on the exterior surface should contain sealing provisions other than the channel type.
		FUEL-10	Provide access from the wing closure ribs in lieu of the moldline when access is required in close proximity to the wing fold area.
		FUEL-11	Through-the-tank fasteners should not be used for fuel cells or tanks in areas where a leak path could be established into an inaccessible portion of the vehicle.
		LG-02	Hardpoints for attachment of landing gear trunnions should be capable of carrying all induced gear loads for the life of the airframe.
		LG-03	Hardpoints for attachment for landing gear trunnions should not be machined as an integral part of the airframe structure when normal design sink rates over 25 feet per second are required.
		LG-04	Do not use Beryllium and Beryllium base alloys in any location subject to wear or corrosive atmospheres or in installations where machining may be required.
		LG-31	Landing gear doors designed to close after gear is extended should be capable of being manually opened on the ground without reliance on electrical or hydraulic power.
		LG-32	Design of landing gear doors normally closed after gear extension should ensure failure modes will not enable uncommanded opening on the ground.

Guidelines by Category (Cont'd)

Category No.	Category Title	Guideline No.	Guideline
3.03.07	Cargo Holds, Storage Bays, and Storage Compartments	LG-33	Design of landing gear doors normally left open after gear extension should ensure no failure mode will enable closing on the ground.
		LG-34	Avoid sharp edges and corners on landing gear doors or fairings.
		LG-35	Avoid the use of landing gear doors to mount or house antennas, arrays, or air data sensors.
		LG-36	Location of integral wheel jack points on a strut should provide a minimum 6-1/2 inch clearance for positioning the jack with tire ruptured and wheel ground 2 inches off ground.
		LG-37	Integral hardpoints to jack the entire vehicle should ensure that identical jacks can be used at all jack points.
		LG-38	All landing gear doors should be interchangeable.
		LG-39	Gear-mounted tie-down or chain-down fittings should be interchangeable and easily replaceable.
		LO-01	Use LO compatible gap fillers for manufactured gaps in lieu of tape and butter (surface coating compound).
		LO-02	Avoid scheduled forced inspections or replacement of materials, coatings, or finishes solely to protect either the reliability or the signature.
		LO-04	Infrequently-accessed structural doors and panels incorporating special coatings or conductive paints should contain provisions for prying the door or panel clear of moldline with standard screwdriver without damage.
		LO-05	Do not locate flush mounted LO screens for auxiliary air inlets and exits in walkway areas unless durability has been proven.
		LO-06	Size flush mounted LO screens for auxiliary air inlets and exits to ensure functionality with up to 25 percent of the openings plugged.
		LO-07	Flush and non-flush LO screens should be interchangeable.
		MATL-02	Cosmetic type repairs should not exceed 1 hours including cure or drying times.
		MATL-03	Cosmetic and vehicle repair material shelf life should not be less than 24 months.
		MATL-04	Cosmetic and vehicle repair materials should be non-proprietary and non-single source.
		MATL-05	Cosmetic and vehicle repair materials should not require refrigeration or special facilities or atmospheres for storage.
		MATL-06	Repair criteria, repairs, and instructions should not be classified.
		MATL-07	All cosmetic touch-up and repair materials should be environmentally safe.
		MATL-08	Repairs (other than major depot repair) should not require autoclave type facilities.
		MATL-09	A high degree of durability should be achieved across all walkway areas on the top surfaces of all vehicles up to and including 95 percentile personnel.
		MATL-10	Coatings and finishes should be durable against the effects of missile gases, velocities, and particles emanating from the missile motor.
		MATL-11	Coatings and finishes should be durable against the effects of gun gases, projectile shock waves, and brass particles emanating from the projectile seal rings.
		MATL-12	Leading edge materials and coatings should be durable against fragments from frangible gun port plugs.
		MATL-13	Special handling or shipping requirements of repair materials should be avoided.
		MATL-14	Leading edges, including chines, containing or constructed of radar absorbing materials, should be interchangeable to reduce vehicle downtime and simplify repairs.
		MATL-15	Doors and panels containing blade seals used for signature reduction should be interchangeable or contain interchangeable blade seals. Deviation is acceptable where repairs can be accomplished on the vehicle in a time equal to or less than door or seal remove and replace time.
		MC-03	All tubing connections and interfaces should use rosan/dynatube (or equivalent) to (1) enable connect or disconnect with one hand, one tool, (2) eliminate the need to safety the connection, (3) provide a superior seal, and (4) negate need to reposition line(s) during component replacement.
		MC-05	Avoid potential foreign object traps during manufacturing or operational maintenance by eliminating vertical penetrations of plumbing/fittings into tanks, compartments, or cells
		MC-06	Locate, position, orient all plumbing and duct electrical connectors to prevent the need for sequential installation or removal.

Guidelines by Category (Cont'd)

Category No.	Category Title	Guideline No.	Guideline
3.03.07	Cargo Holds, Storage Bays, and Storage Compartments	MC-09	All plumbing connections and fittings used for fuel systems should contain integral bonding features to eliminate the need for bonding clamps or jumper cables.
		MC-10	In rare instances where a plumbing run contains complex form or geometry that would require removal of other plumbing or equipment for access, in-line connectors should be incorporated to maintain the integrity of other plumbing or equipment.
		MC-11	No subsystem plumbing, equipment, or wiring should use a tank, cell, or compartment containing liquids as a means for routing or penetration simplicity during manufacture.
		MC-12	All plumbing and connectors containing liquids should be meniscus-free.
		MC-13	In instances where plumbing or connector interfaces cannot or are not keyed for a specific orientation, all identification, markings, cautions, and directions should be placed 360 degrees around the tube or duct.
		MC-14	Where multiple connectors are located in close proximity, ensure (1) a minimum hand tool arc of 120 degrees can be maintained, and (2) stagger fittings to ensure firm coupling interface/hand tool interface can be accomplished without inducing damage to adjacent lines.
		MC-15	Route, orient, and position plumbing, wiring, ducts, and connectors sufficiently away from the outer surface of the vehicle to preclude induced damage due to minor dents, drill bits during repair, etc. Minimum rule of thumb is 1" away from the inner surface and 1" below a plate nut channel.
		OXY-05	Locate liquid oxygen (LOX) containers in a sealed, dedicated compartment to eliminate need for frequent visual inspections.
		P-01	Access door and panel fastener types for airborne vehicles should meet the following criteria: <ul style="list-style-type: none"> - use latches for a frequency of access of 0 to 40 flight hours - use High Strength Quick Release fasteners for a frequency of access of 40-400 flight hours - use structural screws for a frequency of access of 400 flight hours or more
		P-02	Access door and panel fastener types for surface vehicles should meet the following criteria: <ul style="list-style-type: none"> - use a spring loaded or latch fastener for an opening frequency of daily - use a one quarter turn fastener (or equivalent) for an opening frequency of weekly - use screws or bolts for all other cases
		P-03	All doors and panels subject to environmental elements should contain form-in-place seals (or equivalent) attached to the door structure, not substructure, to prevent damage during maintenance.
		P-04	Door and panel seals should be compatible with all types of on-board servicing fluids, de-ice and anti-ice fluids, and all fluids used for chemical, biological, and nuclear decontamination.
		P-05	Piano type hinges should not be used on doors or panels because they are subject to wear, corrosion, and sand and fluid entry.
		P-06	Access door and panel devices used to support door in opened position should meet the following criteria: <ul style="list-style-type: none"> - for airborne vehicles, design for 60 knot gust loads (or equivalent jet blast loads) - for ground vehicles, design for 50 mph gust loads
		P-07	Hinged access doors and panels capable of remaining in the opened position should not have sharp edges or corners.
		P-08	Removable access door and panel fasteners should be of identical grip length and diameter.
		P-09	Acceptable door and panel hold-open devices include over-center sheet metal spring, over-center spring link, spring cartridge, support strut, and pinned goose neck hinge.
		P-10	Access doors and panels requiring non-captive fasteners should not be located forward of air inlet ducts or high-energy rotating components (e.g., prop fans, engine cooling fans, etc.).
		P-11	Access doors and panels should be interchangeable as justified by operation and support costs or life cycle costs.
		PERS-06	Storage bins, compartments, sacks, or bags should be available within the vehicle to store/protect all personal equipment required to conduct operations.
		PERS-07	All flight and ground vehicles should contain one cubic foot minimum storage compartment(s) for various loose and sundry personal items (for each individual).
		PERS-08	Design stowage and mounting provisions for portable air or oxygen containers to withstand 40G crash or impact loads.

Guidelines by Category (Cont'd)

Category No.	Category Title	Guideline No.	Guideline
3.03.07	Cargo Holds, Storage Bays, and Storage Compartments	PERS-09	Design portable emergency locator beacons, radio receiver/transmitters, global positioning systems, and similar battery operated devices with integral provisions for determining battery health or status and remaining battery life.
		PYRO-26	Do not locate ammunition loader interfaces close to inlets, exhausts, fuel dumps and drains, antennas, sensors, lights, or hazardous protrusions.
		PYRO-27	Incorporate integral hoisting provisions at each weapon/store station to enable direct lift from the container or carrier to the attachment hardpoints.
		PYRO-28	Automatic locking of the retention hooks should be accomplished for each respective weapon and store.
		PYRO-32	Provide sufficient longitudinal clearance between weapon bays to enable simultaneous loading of two bays.
		PYRO-33	Provide sufficient lateral clearance between weapon bays to enable simultaneous loading of two bays.
		PYRO-34	Weapon bay door seals should be bonded or attached to door structure to minimize induced seal damage during weapon or store loading.
		PYRO-35	Suspension system should permit any single weapon or store to be loaded by a two man crew.
		SABCH-01	Do not locate auxiliary air inlets, sensors, access doors, or drains in boundary bleed areas.
		SABCH-02	All flush type structural screws should have identical head drives for the entire vehicle.
		SABCH-03	All non-flush type structural screws should have identical head drive recesses for the entire vehicle.
		SABCH-04	Special high strength bolts, such as twelve-point heads, should be fully justified from standpoint of the cost of ownership and effectiveness.
		SABCH-05	Structural design should avoid the reliance on blind fasteners unless fully supported by cost, weight, schedule, and effectiveness analysis.
		SABCH-06	Structural design should avoid the potential of dissimilar material or fastener corrosion.
		SABCH-07	No structural fasteners should be used that require special tools for installation.
		SABCH-08	Taper pins should be threaded and retained with self-locking hardware.
		SABCH-09	Pins and collars (lockbolts) should only be used in applications which do not normally require removal.
		SABCH-10	Do not use lockbolts in composites.
		SABCH-11	In rare instances where the use of dissimilar material in immediate contact cannot be avoided, they should be sufficiently insulated to endure for the life of the vehicle.
		SABCH-12	Avoid tapping threads into structural members. Use of heli-coil type or similar insert concepts is permissible.
		SABCH-13	No structural design concept should rely on frequent scheduled inspections to monitor or otherwise ensure structural integrity.
		SABCH-14	No structural fastener intended to carry shear or tension loads should be smaller than 1/4" diameter (.25").
		SABCH-15	Give preference to butt type splices over lap type splices in the design of manufacturing splices.
		SABCH-16	Wing-to-fuselage attachment should give preference to tension ties over shear ties to improve overall volumetric efficiency.
		SABCH-17	Hardpoints for securing tie down chains, cables, and devices during transport should not require reaching under or crawling under the vehicle.
		SABCH-18	Rings, posts, and clevis devices used for attaching tie downs should not require opening of doors or panels for access.
		SABCH-19	Avoid tie down concepts requiring attaching hardpoints as a prerequisite.
		SABCH-20	Location of hardpoints used for tie down attachment should: <ul style="list-style-type: none"> - Remain outside of door and panel opening envelopes. - Be clear of exhaust pipes, ducts, manifolds, and mufflers. - Be clear of overboard fluid drains and vents.
		SAFE-01	Drag chute installation designs not containing electrical safing should contain remote safe/arm provisions reachable from ground level by 5 percentile females. Remove location should be clear of engine exhaust areas and flight control deflection envelopes.
		SAFE-02	Emergency ingress actuation provisions into cockpits, crew stations, passenger compartments, and operator stations should be accessible from the ground by 5 percentile females.

Guidelines by Category (Cont'd)

Category No.	Category Title	Guideline No.	Guideline
3.03.07	Cargo Holds, Storage Bays, and Storage Compartments	SAFE-05	Crash locator beacon door opening/ejection mechanisms should contain integral electrical safe/arm features.
		SIMP-01	Location and design of all exterior lights should not require protective covers in ground environments.
		SIMP-03	Speed brake or speed brake cavity should contain integral mechanical locking mechanism for personnel safety.
		SURV-01	Design containers used for dinghy stowage to be structurally capable of containing the dinghy within the event of unintentional or uncommanded inflation.
		SURV-02	Provide crew stations, crew compartments, and operator areas containing dinghies as emergency equipment with a suitable tool for puncturing or cutting the dinghy in the event of inadvertent inflation. Locate the tool so that access is assured during dinghy inflation.
		W-01	Hat section type structural stiffeners with sufficient cross sectional area should be considered as a routing tunnel for wiring and coax.
		WBAY-01	Equipment bays and compartments should not require installation of special cavity fillers when equipment is not installed.
		WBAY-11	Gap seal should match pylon and wing/fuselage surface impedance.
		WBAY-12	Pylon-to-store/weapon gap seal should permit visual and physical access during loading for all interfaces between bomb rack-to-store, bomb rack-to-launcher, and launcher-to-store.
		WBAY-13	Pylon-to-store/weapon gap seal should not interfere with automatic sway brace function.
		WBAY-14	Pylon-to-store/weapon gap seal should permit physical access to lanyards.
		WBAY-15	Gap seals should not hinder pilot or ground crew preflight inspection.
		WBAY-17	Special coatings or conductive paints on pylons, launchers, racks, launchers, tanks, pods, etc. should have the durability to withstand contact with support stands/cradles during storage.
		WBAY-18	The proximity of the gun firing barrel to structure should be such that structural furrows or channels are not required for projectile clearances during firing.
3.03.08	Weapon Bays, Racks, Compartments, Pylons, Housings, and Turrets	A-01	Seal equipment bays and compartments against the environmental elements including all types of servicing fluids used for the vehicle, all types of anti-ice and de-ice fluids, and all types of fluids used for chemical, biological, or nuclear decontamination
		A-04	Use stiffening beads in lieu of flanges to the maximum extent to enhance compartment volume and simplify repairs. Stiffening beads should have the convex surface toward the compartment to eliminate fluid traps.
		A-05	Keep all machined compartment frames, webs, and closure panels to a constant thickness (e.g., not stepped or tapered) to ease simplicity of fluid or electrical penetrations and ease and simplicity of structural repair.
		A-06	Hardpoints (structural attachment and load bearing areas) within a compartment to assist in equipment mounting or support should not be integral with the machined part. Hardpoints should be parasitic to enable quick repair in case of wear or damage in lieu of precise ream/bush repair typical of machined hardpoints.
		A-07	Paint equipment bay and compartment interiors a high gloss white to maximize lighting reflectivity, visibility, and rapid leak detection capability.
		A-08	Plumbing penetrations into a compartment should not be on a vertical axis due to difficulty in making or breaking vertically-oriented connections. When compartment access is from the bottom, vertically-oriented connections can allow fluid to leak onto the maintainer. When access is from the top, such connections can allow foreign matter to enter the line. Use horizontal penetrations whenever possible.
		A-09	Any heat or temperature sensitive structure within a compartment should contain heat-sensitive tape or appropriate heat sensor for easy indication of over-temperature excursions.
		A-10	Provide a sufficient number of compartment fluid drains to ensure fluid drainage for varying aircraft static attitudes and varying terrain slopes for ground vehicles.
		A-11	Locate compartment electrical penetrations close to the access opening for ease of sight, probing, repair, and to eliminate fluid soaking, wicking, or contamination.
		A-12	Locate compartment electrical penetrations far enough from the access opening to prevent damage resulting from improper (over-length) panel fasteners.

Guidelines by Category (Cont'd)

Category No.	Category Title	Guideline No.	Guideline
3.03.08	Weapon Bays, Racks, Compartments, Pylons, Housings, and Turrets	A-13	Two-sided or two-surfaced access should not be required for access to equipment interfaces and hardpoints. The term two-sided infers top/bottom, left/right, front/back, or combinations thereof.
		A-14	Do not locate nuplates or gang channels in inaccessible areas that would require extensive disassembly or equipment removal to gain access.
		A-15	Locate tie-down attachment points such that tie-down chains, straps, or cables do not prevent or restrict normal servicing, weapon loading, or safe/arm functions.
		A-16	Structural design should provide good access to corrosion-prone areas for inspection and treatment.
		A-17	All structural fasteners in an access door or panel should be of identical grip and diameter. In rare cases where this is not possible, fasteners of different grip must have different diameters to prevent a shorter fastener being substituted for the correct, longer fastener.
		A-18	Use transparent windows, quick-opening covers, or openings without any cover to permit quick visual inspections where needed.
		ARM-01	For an aircraft, the fuselage lower shear moldline should be no less than 38" above the ground when external weapons only will be carried on the fuselage.
		ARM-02	For an aircraft, the fuselage lower shear moldline should be no less than 50" above the ground when internal weapons will be carried in the fuselage and weapon bay door widths exceed 22".
		ARM-03	Locate fuselage weapon bays a minimum of 18" from the nose landing gear and main landing gear of an aircraft.
		ARM-04	No single weapon/store mounted on a transporter should intrude into the service/tumaround envelope of another station.
		ARM-05	All servicing and tumaround functions (including movement envelopes) should be outside the gun firing envelope.
		ARM-06	The relationship of the nose landing gear to the main landing gear should not restrict the positioning of weapon transporters under the fuselage of an aircraft.
		ARM-07	The design of weapon and store ejectors and launchers should not require scheduled servicing, maintenance, or inspection requirements prior to upload of the weapon or store.
		ARM-08	Weapon and store ejectors containing arming solenoids should ensure the solenoids can be rapidly replaced while installed.
		ARM-09	Weapon and store ejectors containing adjustable pitch control devices should ensure devices are easily accessible and adjustments are Murphy-free.
		ARM-10	Weapon and store stations should be located to ensure vehicle ballasting will not be required under any combination of weapon/store configurations.
		BIT-01	During design of the BIT, use worst-case stress analysis to ensure that any circuit failures induced by temperature extremes, tolerance build-up, power supply variations, and combinations thereof are identified.
		BIT-02	Ensure that BIT system thresholds are consistent with those across the system, subsystem, item, module, and piece-part levels to prevent excessive numbers of Cannot Duplicate (CND) and Retest OK (RTOK) events from occurring.
		BIT-03	The degree of BIT required or proposed should be based on the respective failure rates and the appropriate FMECA at all equipment indeture levels.
		BIT-04	Limit the amount of data that is recorded to a manageable size by: <ul style="list-style-type: none"> - Limiting the number of signals that are monitored - Limiting the maximum sampling rate - Reducing the time span over which data is accumulated - Restricting the type of data accumulated
		BIT-05	Incorporate testability design features as an integral part of equipment preliminary design process.
		BIT-06	Mission critical functions should be monitored by BIT.
		BIT-09	Use concurrent BIT to monitor system critical functions.
		BIT-26	Locate routinely used test points so they are accessible without removing or disassembling other equipment
		BIT/BITE-02	Design EMI protection to eliminate finger type EMI contact devices.
		C-01	Avoid swivel type connectors and fittings for air, fuel, or hydraulic line interfaces due to their history of low reliability.

Guidelines by Category (Cont'd)

Category No.	Category Title	Guideline No.	Guideline
3.03.08	Weapon Bays, Racks, Compartments, Pylons, Housings, and Turrets	C-02	Provide spacing between parallel plumbing runs so that in-line couplings can be replaced without removing lines or disconnecting any line support devices.
		CARGO-01	<p>Ground vehicles with storage bays or compartments accessible from outside the vehicle should:</p> <ul style="list-style-type: none"> - Have the door sill located no lower than knee height to accommodate a wide range of percentiles while standing. - Ensure door handles are flush with outer surface to protect personnel. - Contain goose neck hinges to protect the hinge from the elements. - Contain peripheral door seals that will protect against blowing sand entry at 50 mph. - Ensure door can be opened with transport tie downs installed. - Ensure door opening envelope does not intrude into the opening envelope of an adjacent door. - Contain simple sheet metal hold-open spring or mechanism. - Ensure floor of bay or compartment is flush with sill to simplify cleanout and drainage. - Ensure door unlocking and opening mechanism can be actuated by a 95 percentile male hand while wearing arctic gloves. - Contain 15 percent added volume for density growth. <p>Ground vehicles with small exterior storage bays or compartments containing emergency equipment or supplies should:</p> <ul style="list-style-type: none"> - Be located at chest height of the 50 percentile male. - Contain unlatching mechanisms activated by pushing inward on the door. - Meet all other generic bay and compartment requirements <p>Orient all vehicle liquid servicing fittings to ensure fluids will not come in contact with protective garb during connect/disconnect activities.</p> <p>Ensure vehicle overboard passive liquid drains are clearly marked or visible to enable personnel to remain clear of area.</p> <p>Control rods should use Boyd or impedance type bolts (or equivalent) to eliminate the need for cotter pins or safety wire.</p> <p>Do not use metal control cables for vehicles that will operate in salt water or salt air environments.</p> <p>Use control rods rather than control cables for non-complex applications and non-complex routing within the vehicle.</p> <p>Use control cables rather than control rods for most complex applications.</p> <p>Route cables so that 100 percent of a cable will be viewable for inspection.</p> <p>Design all pulleys and brackets associated with cable installations so they are accessible by a 75 percentile male hand.</p> <p>The geometric aspects of structural design and interfaces should not result in any natural bathtubs.</p> <p>Closed structural sections subject to condensation or fluid migration should contain drainage provisions.</p> <p>Crew cabs, operators' compartments, crew stations, cockpits, and passenger compartments should be subject to the same corrosion prevention measures as the exteriors of the vehicles. Low points, pockets, and related fluid collection points within should be provided with low point drains.</p> <p>Design air inlets, outlets, and exhausts to be accessible without reliance on ladders or work stands for ease of installing protective plugs or covers.</p> <p>Design air inlets, outlets, and exhausts with screens to prevent bird or rodent entry.</p> <p>Design air inlets, outlets, and exhausts to be meniscus-free to prevent a bathtub effect. In remote instances where this is not possible, passive drains should be provided at all low points to prevent liquid accumulation with the vehicle in its normal static attitude.</p> <p>Instances where air inlets, outlets, and exhausts are subject to water entry, passive drains should be employed capable of handling 4" of rain per hour.</p> <p>Locate and orient air inlets, outlets, and exhausts in a manner that prevents their use as footholds during maintenance.</p> <p>Provide surface sensors on equipment located in compartments containing louvers, screens, flush inlets, or similar openings to the environment to indicate the presence of chem/bio contaminants.</p> <p>Provide integral sensors (viewable from the exterior) for equipment subject to internal forced-air cooling from outside or external air to indicate the presence of contaminants.</p> <p>Design equipment surfaces and structure to be compatible with all decontamination agents and methods.</p> <p>Provide passive overboard drains in compartments subject to decontamination processes to void the area of contaminants.</p>
		CARGO-02	
		CBR-01	
		CBR-02	
		CONT-01	
		CONT-02	
		CONT-03	
		CONT-04	
		CONT-05	
		CONT-06	
		D&V-01	
		D&V-02	
		D&V-03	
		ECS-11	
		ECS-12	
		ECS-13	
		ECS-14	
		ECS-15	
		EDECOM-01	
		EDECOM-02	
		EDECOM-03	
		EDECOM-04	

Guidelines by Category (Cont'd)

Category No.	Category Title	Guideline No.	Guideline
3.03.08	Weapon Bays, Racks, Compartments, Pylons, Housings, and Turrets	EDECOM-05	Provide hoist, lift or transport handles for equipment requiring removal from the host vehicle for decontamination. In instances where this may not be practical, design the equipment with hardpoints for attaching parasitic carrying provisions
		ENV-01	Materials, treatments, coatings, finishes should be compatible with all anti-ice and de-ice fluids, chemical and biological decontamination fluids, washing and cleaning fluids, and all vehicle subsystem fluids.
		ENV-02	There should be no top coat or treatment deterioration throughout the standard temperature and humidity spectrum.
		ENV-03	For airborne vehicles, the finishes should be durable against rain, hail, and dynamic erosion throughout the flight envelope.
		ENV-04	For airborne and ground vehicles, the finishes should be durable against sand erosion throughout all surface wind speeds experienced in arid or desert geographical locations.
		EXT-01	Locate Tanks, Pods, Containers, and Devices (TPCD's) so they do not block or restrict access to existing vehicle access areas or access approach envelopes.
		EXT-02	Design TPCD's for fuel containment to automatically interface to the host vehicle during installation or removal.
		EXT-03	Design TPCD's to be fully compatible with the existing vehicle built-in hoisting provisions and locking devices.
		EXT-05	Design access doors for cargo type TPCD's to be non-load carrying and with simple latches for all doors and panels.
		EXT-06	Design cargo TPCD's to ensure all cargo and equipment can be downloaded and uploaded with the TPCD installed on the host vehicle.
		EXTING-01	Use extinguishing concepts dedicated to each individual fire zone in preference to manifold systems operating from a central source.
		EXTING-03	Keep each individual fire zone over-temperature/fire warning system separate from those in other fire zones.
		EXTING-04	Design individual fire zone over-temperature/fire warning system to be fully BIT capable (the BIT concept should permit both initiated and periodic BIT).
		EXTING-06	Provide an alternate capability to activate the system remotely from the cockpit/crew station, or operator's position to satisfy emergency situations during vehicle maintenance.
		EXTING-07	Analyze the vehicle operational environment and type of fire zones to determine if remote stop/shut-off of equipment is warranted.
		EXTING-08	Analyze the vehicle operational environment and type of fire zones to determine if remote alarm and/or visual indication of a fire is warranted.
		EXTING-09	Do not locate provisions for overboard venting or dumping of extinguishing agents in areas that could create hazards for personnel.
		F-01	Use blind fasteners only where absolutely necessary or where considerable cost can be saved.
		F-02	Minimize access fasteners while making them quick release, easily removed and replaced, and captive.
		F-03	Choose fasteners based on the requirement to operate by hand or with common hand tools rather than special tools.
		F-04	Whenever possible, incorporate barrel type fasteners as opposed to hi-torque fasteners. Failure of Hi-torque fasteners due to stripping are common and a source of potential foreign object damage (FOD).
		FUEL-01	Locate fuel vent and dump masts to ensure exiting fuel will be clear of servicing, loading, arming and safing areas for all types of ground and airborne vehicles.
		FUEL-02	Manufacturing splices for major sub-assemblies should not intrude into or through integral fuel cells or tanks.
		FUEL-03	Structural bolts, screws, and fasteners should not penetrate into integral fuel cells or tanks other than those used for access door attachment.
		FUEL-04	Where the fuel wetted area inside a fuel cell or tank is void of blade, knife, and hat stiffeners for use as hardpoint attachment, standoffs bonded to the cell surface should be used as attachments for clamps, and brackets to eliminate fastener penetration of the fuel cavity.
		FUEL-05	Intersecting of two or more surfaces in a fuel wetted area of less than 90 degrees should be avoided to simplify manufacture and repair.
		FUEL-06	Where maintaining a minimum angle of 90 degrees is not possible, sufficient depth, width, and height should be maintained to provide tool clearances for all tools used in the manufacturing processes and in the operational field repair environment.

Guidelines by Category (Cont'd)

Category No.	Category Title	Guideline No.	Guideline
3.03.08	Weapon Bays, Racks, Compartments, Pylons, Housings, and Turrets	FUEL-07	When feed tanks are designed such that the lower portion of the tank serves as a surge chamber, the top closure deck of the surge chamber should provide the strength to support the weight of a 95 percentile male.
		FUEL-08	The size and number of fuel cell and tank access doors should be sufficient to ensure no wetted area of the cell or tank is beyond a maximum 18" distance from the edge of the access opening. This guideline applies to only non-man rated cells.
		FUEL-09	All fuel cell or tank access doors not mounted on the exterior surface should contain sealing provisions other than the channel type.
		FUEL-10	Provide access from the wing closure ribs in lieu of the moldline when access is required in close proximity to the wing fold area.
		FUEL-11	Through-the-tank fasteners should not be used for fuel cells or tanks in areas where a leak path could be established into an inaccessible portion of the vehicle.
		LG-02	Hardpoints for attachment of landing gear trunnions should be capable of carrying all induced gear loads for the life of the airframe.
		LG-03	Hardpoints for attachment for landing gear trunnions should not be machined as an integral part of the airframe structure when normal design sink rates over 25 feet per second are required.
		LG-04	Do not use Beryllium and Beryllium base alloys in any location subject to wear or corrosive atmospheres or in installations where machining may be required.
		LG-05	All bolts or similar threaded means used as adjustable stops should be positively retained in the adjusted reference without reliance on jam nuts, cotter pins, or safety wire.
		LG-31	Landing gear doors designed to close after gear is extended should be capable of being manually opened on the ground without reliance on electrical or hydraulic power.
		LG-32	Design of landing gear doors normally closed after gear extension should ensure failure modes will not enable uncommanded opening on the ground.
		LG-33	Design of landing gear doors normally left open after gear extension should ensure no failure mode will enable closing on the ground.
		LG-34	Avoid sharp edges and corners on landing gear doors or fairings.
		LG-35	Avoid the use of landing gear doors to mount or house antennas, arrays, or air data sensors.
		LG-36	Location of integral wheel jack points on a strut should provide a minimum 6-1/2 inch clearance for positioning the jack with tire ruptured and wheel ground 2 inches off ground.
		LG-37	Integral hardpoints to jack the entire vehicle should ensure that identical jacks can be used at all jack points.
		LG-38	All landing gear doors should be interchangeable.
		LG-39	Gear-mounted tie-down or chain-down fittings should be interchangeable and easily replaceable.
		LO-01	Use LO compatible gap fillers for manufactured gaps in lieu of tape and butter (surface coating compound).
		LO-02	Avoid scheduled forced inspections or replacement of materials, coatings, or finishes solely to protect either the reliability or the signature.
		LO-04	Infrequently-accessed structural doors and panels incorporating special coatings or conductive paints should contain provisions for prying the door or panel clear of moldline with standard screwdriver without damage.
		LO-05	Do not locate flush mounted LO screens for auxiliary air inlets and exits in walkway areas unless durability has been proven.
		LO-06	Size flush mounted LO screens for auxiliary air inlets and exits to ensure functionality with up to 25 percent of the openings plugged.
		LO-07	Flush and non-flush LO screens should be interchangeable.
		MATL-01	A high degree of durability should be maintained for a minimum distance of 36 inches forward of the inflight refueling receptacle.
		MATL-02	Cosmetic type repairs should not exceed 1 hours including cure or drying times.
		MATL-03	Cosmetic and vehicle repair material shelf life should not be less than 24 months.
		MATL-04	Cosmetic and vehicle repair materials should be non-proprietary and non-single source.

Guidelines by Category (Cont'd)

Category No.	Category Title	Guideline No.	Guideline
3.03.08	Weapon Bays, Racks, Compartments, Pylons, Housings, and Turrets	MATL-05	Cosmetic and vehicle repair materials should not require refrigeration or special facilities or atmospheres for storage.
		MATL-06	Repair criteria, repairs, and instructions should not be classified.
		MATL-07	All cosmetic touch-up and repair materials should be environmentally safe.
		MATL-08	Repairs (other than major depot repair) should not require autoclave type facilities.
		MATL-09	A high degree of durability should be achieved across all walkway areas on the top surfaces of all vehicles up to and including 95 percentile personnel.
		MATL-10	Coatings and finishes should be durable against the effects of missile gases, velocities, and particles emanating from the missile motor.
		MATL-11	Coatings and finishes should be durable against the effects of gun gases, projectile shock waves, and brass particles emanating from the projectile seal rings.
		MATL-12	Leading edge materials and coatings should be durable against fragments from frangible gun port plugs.
		MATL-13	Special handling or shipping requirements of repair materials should be avoided.
		MATL-14	Leading edges, including chimes, containing or constructed of radar absorbing materials, should be interchangeable to reduce vehicle downtime and simplify repairs.
		MATL-15	Doors and panels containing blade seals used for signature reduction should be interchangeable or contain interchangeable blade seals. Deviation is acceptable where repairs can be accomplished on the vehicle in a time equal to or less than door or seal remove and replace time.
		MC-01	All clamps should contain torque-set or torque-limiting connections to prevent clamp or component failure due to over-torque. Clamp installation call outs should not depend on special tools to establish the required torque values.
		MC-02	Avoid the use of cotter pins, safety wire, safety clips, and similar devices to prevent maintenance-induced events leading to ground vehicle accidents or loss of air vehicles.
		MC-03	All tubing connections and interfaces should use rosan/dynatube (or equivalent) to (1) enable connect or disconnect with one hand, one tool, (2) eliminate the need to safety the connection, (3) provide a superior seal, and (4) negate need to reposition line(s) during component replacement.
		MC-04	No trombone type, flared tube type, or piloted line type interfaces should be used to avoid the need for removal or repositioning during equipment removal.
		MC-05	Avoid potential foreign object traps during manufacturing or operational maintenance by eliminating vertical penetrations of plumbing/fittings into tanks, compartments, or cells
		MC-06	Locate, position, orient all plumbing and duct electrical connectors to prevent the need for sequential installation or removal.
		MC-09	All plumbing connections and fittings used for fuel systems should contain integral bonding features to eliminate the need for bonding clamps or jumper cables.
		MC-10	In rare instances where a plumbing run contains complex form or geometry that would require removal of other plumbing or equipment for access, in-line connectors should be incorporated to maintain the integrity of other plumbing or equipment.
		MC-11	No subsystem plumbing, equipment, or wiring should use a tank, cell, or compartment containing liquids as a means for routing or penetration simplicity during manufacture.
		MC-12	All plumbing and connectors containing liquids should be meniscus-free.
		MC-13	In instances where plumbing or connector interfaces cannot or are not keyed for a specific orientation, all identification, markings, cautions, and directions should be placed 360 degrees around the tube or duct.
		MC-14	Where multiple connectors are located in close proximity, ensure (1) a minimum hand tool arc of 120 degrees can be maintained, and (2) stagger fittings to ensure firm coupling interface/hand tool interface can be accomplished without inducing damage to adjacent lines.
		MC-15	Route, orient, and position plumbing, wiring, ducts, and connectors sufficiently away from the outer surface of the vehicle to preclude induced damage due to minor dents, drill bits during repair, etc. Minimum rule of thumb is 1" away from the inner surface and 1" below a plate nut channel.

Guidelines by Category (Cont'd)

Category No.	Category Title	Guideline No.	Guideline
3.03.08	Weapon Bays, Racks, Compartments, Pylons, Housings, and Turrets	MP-01	Avoid the use of epoxies to mount parts on repairable modules because they make repair extremely difficult.
		MP-02	Use a unique identification (ID) resistor incorporated in each system module to verify that the proper module is mounted on ATE.
		MP-03	Design modules so that lengthy warm-up times, special coding and air purity levels, and similar constraints are not necessary.
		P-01	Access door and panel fastener types for airborne vehicles should meet the following criteria: <ul style="list-style-type: none"> - use latches for a frequency of access of 0 to 40 flight hours - use High Strength Quick Release fasteners for a frequency of access of 40-400 flight hours - use structural screws for a frequency of access of 400 flight hours or more
		P-02	Access door and panel fastener types for surface vehicles should meet the following criteria: <ul style="list-style-type: none"> - use a spring loaded or latch fastener for an opening frequency of daily - use a one quarter turn fastener (or equivalent) for an opening frequency of weekly - use screws or bolts for all other cases
		P-03	All doors and panels subject to environmental elements should contain form-in-place seals (or equivalent) attached to the door structure, not substructure, to prevent damage during maintenance.
		P-04	Door and panel seals should be compatible with all types of on-board servicing fluids, de-ice and anti-ice fluids, and all fluids used for chemical, biological, and nuclear decontamination.
		P-05	Piano type hinges should not be used on doors or panels because they are subject to wear, corrosion, and sand and fluid entry.
		P-06	Access door and panel devices used to support door in opened position should meet the following criteria: <ul style="list-style-type: none"> - for airborne vehicles, design for 60 knot gust loads (or equivalent jet blast loads) - for ground vehicles, design for 50 mph gust loads
		P-07	Hinged access doors and panels capable of remaining in the opened position should not have sharp edges or corners.
		P-08	Removable access door and panel fasteners should be of identical grip length and diameter.
		P-09	Acceptable door and panel hold-open devices include over-center sheet metal spring, over-center spring link, spring cartridge, support strut, and pinned goose neck hinge.
		P-10	Access doors and panels requiring non-captive fasteners should not be located forward of air inlet ducts or high-energy rotating components (e.g., prop fans, engine cooling fans, etc.).
		P-11	Access doors and panels should be interchangeable as justified by operation and support costs or life cycle costs.
		PYRO-01	Provide the "safe/arm" status to the pilot, crew, or gunner in the cockpit, crew station, or operator station as appropriate.
		PYRO-02	Provide the "safe/arm" status as an external cue discernible from a distance of 10-20 feet.
		PYRO-06	"Safe/arm" mechanism design should be free from FOD potential.
		PYRO-07	Manual "safe/arm" mechanisms should be well-clear of inlet ducts, propellers, rotors, and similar rotating components.
		PYRO-08	Manual "safe/arm" mechanisms should be well-clear of engine exhausts, fuel/toxic vents, fluid drains, control surface deflection envelopes, and rescue path envelopes.
		PYRO-09	Provide positive, Murphy-proof locking detents for both the "safe" and "arm" positions of mechanical mechanisms.
		PYRO-10	Provide a numerical maintenance code on maintenance panels or maintenance recorder/memory systems to denote the "safe/arm" status for each weapon or store.
		PYRO-11	Design electrical/electronic "safe/arm" systems to eliminate the need for mechanical type system interrupt devices.
		PYRO-12	Design of weapons, flare/chaff packages, and airborne pyrotechnic containers should follow the "wooden round" design concept to eliminate scheduled tests, checks, and inspections throughout its intended life cycle.
		PYRO-13	Container design for shipping, handling, and storing weapons, flares, chaff, and similar devices should not require special atmospheres.
		PYRO-14	Design weapon drop and fire/release circuits with frequency-coded firing systems or similar concepts to ensure stray energy tests and checks will not be required and that stray energy will not impose a safety hazard or problem.

Guidelines by Category (Cont'd)

Category No.	Category Title	Guideline No.	Guideline
3.03.08	Weapon Bays, Racks, Compartments, Pylons, Housings, and Turrets	PYRO-15	Pylon-to-weapon and pylon-to-air vehicle electrical interfaces should contain built-in test/fault location capabilities.
		PYRO-16	Do not use cartridge actuated devices (CADs) for store or weapon ejection or for pylon jettison due to inherent ground safety hazards, stray energy hazards, and scheduled cleaning requirements.
		PYRO-17	In rare instances where use of CADs may be required, a positive indication to denote "cartridge installed" should be provided.
		PYRO-20	Weapon bay doors, when opened, should not block or restrict access to other servicing points.
		PYRO-21	Weapon bays should contain internal lighting controlled by a separate switch that is only functional when doors are open
		PYRO-22	A "rounds remaining" status should be available at the gun loading interface, maintenance panel, or cockpit/crew station/operator station.
		PYRO-23	Crew size for full ammo load should not exceed two persons.
		PYRO-24	Ammo loader interface should not be less than 30" nor more than 50" above the ground to ensure loading can be accomplished by a wide range of percentiles wearing chemical or biological protective gear.
		PYRO-25	Gun loading and servicing should be possible concurrently with all other weapon loading and servicing activities to minimize the elapsed downtime.
		PYRO-26	Do not locate ammunition loader interfaces close to inlets, exhausts, fuel dumps and drains, antennas, sensors, lights, or hazardous protrusions.
		PYRO-27	Incorporate integral hoisting provisions at each weapon/store station to enable direct lift from the container or carrier to the attachment hardpoints.
		PYRO-28	Automatic locking of the retention hooks should be accomplished for each respective weapon and store.
		PYRO-29	Provide quick mechanical over-travel (no power) for weapon bay doors to maximize the weapon/store loading envelope.
		PYRO-30	Ensure weapon bay door arc (both normal and over-travel) does not block or intrude into adjacent service points or envelopes.
		PYRO-32	Provide sufficient longitudinal clearance between weapon bays to enable simultaneous loading of two bays.
		PYRO-33	Provide sufficient lateral clearance between weapon bays to enable simultaneous loading of two bays.
		PYRO-34	Weapon bay door seals should be bonded or attached to door structure to minimize induced seal damage during weapon or store loading.
		PYRO-35	Suspension system should permit any single weapon or store to be loaded by a two man crew.
		PYRO-36	Suspension system design and spacing should enable any combination of eight weapons to be loaded by two two-man crews within the refueling time of the vehicle (excludes nuclear weapons).
		PYRO-37	Internal weapon suspension arrangements should preclude sequential weapon loading.
		PYRO-39	Weapon bay ejectors and launchers should have the capability for total interchangeability and reconfigurability.
		PYRO-41	Weapon or store handling and transportation equipment should be compatible with rough terrain and capable of 25 mph towing speeds minimum.
		PYRO-42	In weapons carriage design and integration, avoid dependence of on-board high pressure nitrogen.
		PYRO-43	Launcher or ejector design/interface should not require a dual function of carrying airframe structural loads.
		PYRO-44	Launcher and ejector design should incorporate automatic sway bracing.
		PYRO-45	Missile ejectors should be provided with repeatable missile motor fire wires to simplify loading and reduce elapsed time.
		PYRO-46	Design pylons, launchers, and ejector racks so that weapon loading, servicing, and reconfigurations can be accomplished using standard hand tools.
		PYRO-47	Installation design of ejectors, launchers, racks, and associated hardware interfaces should avoid reliance on torque wrenches.
		SABCH-01	Do not locate auxiliary air inlets, sensors, access doors, or drains in boundary bleed areas.
		SABCH-02	All flush type structural screws should have identical head drives for the entire vehicle.
		SABCH-03	All non-flush type structural screws should have identical head drive recesses for the entire vehicle.

Guidelines by Category (Cont'd)

Category No.	Category Title	Guideline No.	Guideline
3.03.08	Weapon Bays, Racks, Compartments, Pylons, Housings, and Turrets	SABCH-04	Special high strength bolts, such as twelve-point heads, should be fully justified from standpoint of the cost of ownership and effectiveness.
		SABCH-05	Structural design should avoid the reliance on blind fasteners unless fully supported by cost, weight, schedule, and effectiveness analysis.
		SABCH-06	Structural design should avoid the potential of dissimilar material or fastener corrosion.
		SABCH-07	No structural fasteners should be used that require special tools for installation.
		SABCH-08	Taper pins should be threaded and retained with self-locking hardware.
		SABCH-09	Pins and collars (lockbolts) should only be used in applications which do not normally require removal.
		SABCH-10	Do not use lockbolts in composites.
		SABCH-11	In rare instances where the use of dissimilar material in immediate contact cannot be avoided, they should be sufficiently insulated to endure for the life of the vehicle.
		SABCH-12	Avoid tapping threads into structural members. Use of heli-coil type or similar insert concepts is permissible.
		SABCH-13	No structural design concept should rely on frequent scheduled inspections to monitor or otherwise ensure structural integrity.
		SABCH-14	No structural fastener intended to carry shear or tension loads should be smaller than 1/4" diameter (.25").
		SABCH-15	Give preference to butt type splices over lap type splices in the design of manufacturing splices.
		SABCH-16	Wing-to-fuselage attachment should give preference to tension ties over shear ties to improve overall volumetric efficiency.
		SABCH-17	Hardpoints for securing tie down chains, cables, and devices during transport should not require reaching under or crawling under the vehicle.
		SABCH-18	Rings, posts, and clevis devices used for attaching tie downs should not require opening of doors or panels for access.
		SABCH-19	Avoid tie down concepts requiring attaching hardpoints as a prerequisite.
		SABCH-20	Location of hardpoints used for tie down attachment should: - Remain outside of door and panel opening envelopes. - Be clear of exhaust pipes, ducts, manifolds, and mufflers. - Be clear of overboard fluid drains and vents.
		SAFE-12	Internal weapon bay doors should contain integral safety locking features for use during maintenance and weapon loading and downloading.
		SAFE-13	It should not be possible to unsafe a weapon bay door integral lock when a door closed signal is present.
		SE-04	Gun port covers or plugs should be lightweight, 100% effective, and easy to install or store.
		W-01	Hat section type structural stiffeners with sufficient cross sectional area should be considered as a routing tunnel for wiring and coax.
		WBAY-01	Equipment bays and compartments should not require installation of special cavity fillers when equipment is not installed.
		WBAY-02	Pylon-to-wing electrical or plumbing interfaces should have automatic close-out covers when pylon is jettisoned or not installed.
		WBAY-03	The method and position of the pylon-to-wing gap scale should not form a drip edge for leakage into the pylon cavity.
		WBAY-04	The gap treatment should be a permanent installation on the pylon, wing, or both, not a separate seal.
		WBAY-05	Gap treatment should not interfere with or be damaged by existing pylon handling support equipment.
		WBAY-06	Pylon rigging should not be required for gap seal control.
		WBAY-07	Gap seal should not degrade interchangeability of pylon.
		WBAY-08	Gap seal and treatment should be fully compatible with steam from carrier catapults.
		WBAY-09	Gap seal/pylon should not cover or hamper access to low point wing drains.
		WBAY-10	No loose hardware should exist before or after pylon is installed.
		WBAY-11	Gap seal should match pylon and wing/fuselage surface impedance.

MIL-HDBK-470A

APPENDIX C

Guidelines by Category (Cont'd)

Category No.	Category Title	Guideline No.	Guideline		
3.03.08	Weapon Bays, Racks, Compartments, Pylons, Housings, and Turrets	WBAY-12	Pylon-to-store/weapon gap seal should permit visual and physical access during loading for all interfaces between bomb rack-to-store, bomb rack-to-launcher, and launcher-to-store.		
		WBAY-13	Pylon-to-store/weapon gap seal should not interfere with automatic sway brace function.		
		WBAY-14	Pylon-to-store/weapon gap seal should permit physical access to lanyards.		
		WBAY-15	Gap seals should not hinder pilot or ground crew preflight inspection.		
		WBAY-16	Gap seals should not degrade loading while wearing arctic or chemical, biological, or radiation protective clothing.		
		WBAY-17	Special coatings or conductive paints on pylons, launchers, racks, launchers, tanks, pods, etc. should have the durability to withstand contact with support stands/cradles during storage.		
		WBAY-18	The proximity of the gun firing barrel to structure should be such that structural furrows or channels are not required for projectile clearances during firing.		
		WBAY-19	Frangible gun ports should take preference over mechanized gun port doors.		
		WBAY-20	Gun plugs required solely to maintain a given signature level should be capable of on-board stowage for use only when a threat requires their presence.		
		WBAY-21	Coatings and finishes in the area of gun barrels should be durable to withstand the effect of exiting projectile shockwaves.		
		WBAY-22	The proximity of the gun blast deflector to structure should not require reliance on high-temperature paints or coatings to protect the structure.		
		WIND-01	Optical window materials should be scratch resistant, easy to clean, and dissipate electrostatic charges.		
		WIND-02	Optic windows should be located for ease of inspection, cleaning, and induced damage potential from personnel or support equipment.		
		WIND-03	Window locations should minimize the effects of contamination by salt spray, bugs, oils, fuels, and icing.		
		WIND-04	Window, canopy, and windshield material should be designed to withstand the effects of sandstorms in the ground environment and the effects of rain and hail during thunderstorm penetration in the airborne environment.		
		WIND-05	Design interior surfaces to be reachable for cleaning without reliance on hinging, equipment removal, or use of support equipment.		
		3.03.09	External and Parasitic Tanks, Pods, Containers, and Devices	A-01	Seal equipment bays and compartments against the environmental elements including all types of servicing fluids used for the vehicle, all types of anti-ice and de-ice fluids, and all types of fluids used for chemical, biological, or nuclear decontamination.
				A-06	Hardpoints (structural attachment and load bearing areas) within a compartment to assist in equipment mounting or support should not be integral with the machined part. Hardpoints should be parasitic to enable quick repair in case of wear or damage in lieu of precise ream/bush repair typical of machined hardpoints.
				A-07	Paint equipment bay and compartment interiors a high gloss white to maximize lighting reflectivity, visibility, and rapid leak detection capability.
				A-08	Plumbing penetrations into a compartment should not be on a vertical axis due to difficulty in making or breaking vertically-oriented connections. When compartment access is from the bottom, vertically-oriented connections can allow fluid to leak onto the maintainer. When access is from the top, such connections can allow foreign matter to enter the line. Use horizontal penetrations whenever possible.
				A-09	Any heat or temperature sensitive structure within a compartment should contain heat-sensitive tape or appropriate heat sensor for easy indication of over-temperature excursions.
				A-10	Provide a sufficient number of compartment fluid drains to ensure fluid drainage for varying aircraft static attitudes and varying terrain slopes for ground vehicles.
A-11	Locate compartment electrical penetrations close to the access opening for ease of sight, probing, repair, and to eliminate fluid soaking, wicking, or contamination.				
A-12	Locate compartment electrical penetrations far enough from the access opening to prevent damage resulting from improper (over-length) panel fasteners.				
A-13	Two-sided or two-surfaced access should not be required for access to equipment interfaces and hardpoints. The term two-sided infers top/bottom, left/right, front/back, or combinations thereof.				

Guidelines by Category (Cont'd)

Category No.	Category Title	Guideline No.	Guideline
3.03.09	External and Parasitic Tanks, Pods, Containers, and Devices	A-14	Do not locate nutplates or gang channels in inaccessible areas that would require extensive disassembly or equipment removal to gain access.
		A-15	Locate tie-down attachment points such that tie-down chains, straps, or cables do not prevent or restrict normal servicing, weapon loading, or safe/arm functions.
		A-16	Structural design should provide good access to corrosion-prone areas for inspection and treatment.
		A-17	All structural fasteners in an access door or panel should be of identical grip and diameter. In rare cases where this is not possible, fasteners of different grip must have different diameters to prevent a shorter fastener being substituted for the correct, longer fastener.
		A-18	Use transparent windows, quick-opening covers, or openings without any cover to permit quick visual inspections where needed.
		ARM-01	For an aircraft, the fuselage lower shear moldline should be no less than 38" above the ground when external weapons only will be carried on the fuselage.
		ARM-02	For an aircraft, the fuselage lower shear moldline should be no less than 50" above the ground when internal weapons will be carried in the fuselage and weapon bay door widths exceed 22".
		ARM-03	Locate fuselage weapon bays a minimum of 18" from the nose landing gear and main landing gear of an aircraft.
		ARM-04	No single weapon/store mounted on a transporter should intrude into the service/turnaround envelope of another station.
		ARM-05	All servicing and turnaround functions (including movement envelopes) should be outside the gun firing envelope.
		ARM-06	The relationship of the nose landing gear to the main landing gear should not restrict the positioning of weapon transporters under the fuselage of an aircraft.
		ARM-07	The design of weapon and store ejectors and launchers should not require scheduled servicing, maintenance, or inspection requirements prior to upload of the weapon or store.
		ARM-08	Weapon and store ejectors containing arming solenoids should ensure the solenoids can be rapidly replaced while installed.
		ARM-09	Weapon and store ejectors containing adjustable pitch control devices should ensure devices are easily accessible and adjustments are Murphy-free.
		ARM-10	Weapon and store stations should be located to ensure vehicle ballasting will not be required under any combination of weapon/store configurations.
		BIT-01	During design of the BIT, use worst-case stress analysis to ensure that any circuit failures induced by temperature extremes, tolerance build-up, power supply variations, and combinations thereof are identified.
		BIT-02	Ensure that BIT system thresholds are consistent with those across the system, subsystem, item, module, and piece-part levels to prevent excessive numbers of Cannot Duplicate (CND) and Retest OK (RTOK) events from occurring.
		BIT-03	The degree of BIT required or proposed should be based on the respective failure rates and the appropriate FMECA at all equipment indenture levels.
		BIT-04	Limit the amount of data that is recorded to a manageable size by: <ul style="list-style-type: none"> - Limiting the number of signals that are monitored - Limiting the maximum sampling rate - Reducing the time span over which data is accumulated - Restricting the type of data accumulated
		BIT-05	Incorporate testability design features as an integral part of equipment preliminary design process.
		BIT-06	Mission critical functions should be monitored by BIT.
		BIT-09	Use concurrent BIT to monitor system critical functions.
		BIT-26	Locate routinely used test points so they are accessible without removing or disassembling other equipment
		BIT/BITE-02	Design EMI protection to eliminate finger type EMI contact devices.
		C-01	Avoid swivel type connectors and fittings for air, fuel, or hydraulic line interfaces due to their history of low reliability.
		C-02	Provide spacing between parallel plumbing runs so that in-line couplings can be replaced without removing lines or disconnecting any line support devices.

Guidelines by Category (Cont'd)

Category No.	Category Title	Guideline No.	Guideline
3.03.09	External and Parasitic Tanks, Pods, Containers, and Devices	CARGO-01	<p>Ground vehicles with storage bays or compartments accessible from outside the vehicle should:</p> <ul style="list-style-type: none"> - Have the door sill located no lower than knee height to accommodate a wide range of percentiles while standing. - Ensure door handles are flush with outer surface to protect personnel. - Contain goose neck hinges to protect the hinge from the elements. - Contain peripheral door seals that will protect against blowing sand entry at 50 mph. - Ensure door can be opened with transport tie downs installed. - Ensure door opening envelope does not intrude into the opening envelope of an adjacent door. - Contain simple sheet metal hold-open spring or mechanism. - Ensure floor of bay or compartment is flush with sill to simplify cleanout and drainage. - Ensure door unlocking and opening mechanism can be actuated by a 95 percentile male hand while wearing arctic gloves. - Contain 15 percent added volume for density growth.
		CARGO-02	<p>Ground vehicles with small exterior storage bays or compartments containing emergency equipment or supplies should:</p> <ul style="list-style-type: none"> - Be located at chest height of the 50 percentile male. - Contain unlatching mechanisms activated by pushing inward on the door. - Meet all other generic bay and compartment requirements.
		CBR-01	<p>Orient all vehicle liquid servicing fittings to ensure fluids will not come in contact with protective garb during connect/disconnect activities.</p>
		CBR-02	<p>Ensure vehicle overboard passive liquid drains are clearly marked or visible to enable personnel to remain clear of area.</p>
		CONT-01	<p>Control rods should use Boyd or impedance type bolts (or equivalent) to eliminate the need for cotter pins or safety wire.</p>
		CONT-02	<p>Do not use metal control cables for vehicles that will operate in salt water or salt air environments.</p>
		CONT-03	<p>Use control rods rather than control cables for non-complex applications and non-complex routing within the vehicle.</p>
		CONT-04	<p>Use control cables rather than control rods for most complex applications.</p>
		CONT-05	<p>Route cables so that 100 percent of a cable will be viewable for inspection.</p>
		CONT-06	<p>Design all pulleys and brackets associated with cable installations so they are accessible by a 75 percentile male hand.</p>
		CREW-11	<p>Design cameras, lenses, reconnaissance pods, aiming devices, and related equipment so they can be reconfigured by one individual.</p>
		CREW-13	<p>Provide storage provisions in each vehicle type (ground and airborne) to store extra tapes, modules, cassettes, as appropriate to the intended vehicle use/mission.</p>
		D&V-01	<p>The geometric aspects of structural design and interfaces should not result in any natural bathtubs.</p>
		D&V-02	<p>Closed structural sections subject to condensation or fluid migration should contain drainage provisions.</p>
		D&V-03	<p>Crew cabs, operators' compartments, crew stations, cockpits, and passenger compartments should be subject to the same corrosion prevention measures as the exteriors of the vehicles. Low points, pockets, and related fluid collection points within should be provided with low point drains.</p>
		EDECOM-01	<p>Provide surface sensors on equipment located in compartments containing louvers, screens, flush inlets, or similar openings to the environment to indicate the presence of chem/bio contaminants.</p>
		EDECOM-02	<p>Provide integral sensors (viewable from the exterior) for equipment subject to internal forced-air cooling from outside or external air to indicate the presence of contaminants.</p>
		EDECOM-03	<p>Design equipment surfaces and structure to be compatible with all decontamination agents and methods.</p>
		EDECOM-04	<p>Provide passive overboard drains in compartments subject to decontamination processes to void the area of contaminants.</p>
		EDECOM-05	<p>Provide hoist, lift or transport handles for equipment requiring removal from the host vehicle for decontamination. In instances where this may not be practical, design the equipment with hardpoints for attaching parasitic carrying provisions.</p>
		ENV-01	<p>Materials, treatments, coatings, finishes should be compatible with all anti-ice and de-ice fluids, chemical and biological decontamination fluids, washing and cleaning fluids, and all vehicle subsystem fluids.</p>
		ENV-02	<p>There should be no top coat or treatment deterioration throughout the standard temperature and humidity spectrum.</p>

Guidelines by Category (Cont'd)

Category No.	Category Title	Guideline No.	Guideline
3.03.09	External and Parasitic Tanks, Pods, Containers, and Devices	ENV-03	For airborne vehicles, the finishes should be durable against rain, hail, and dynamic erosion throughout the flight envelope.
		ENV-04	For airborne and ground vehicles, the finishes should be durable against sand erosion throughout all surface wind speeds experienced in arid or desert geographical locations.
		ENV-06	For ground vehicles, the finishes should be compatible with and durable against all rain, hail, sleet, snow, and ice conditions experienced in all intended operational environments.
		EXH-01	Treatments required for engine hot sections and exhaust areas should not require scheduled removals for the purposes of recoating.
		EXH-02	High temperature exhaust patterns should flow away from or be directed away from treated surrounding structure, coatings, or finishes.
		EXT-01	Locate Tanks, Pods, Containers, and Devices (TPCD's) so they do not block or restrict access to existing vehicle access areas or access approach envelopes.
		EXT-02	Design TPCD's for fuel containment to automatically interface to the host vehicle during installation or removal.
		EXT-03	Design TPCD's to be fully compatible with the existing vehicle built-in hoisting provisions and locking devices.
		EXT-04	Design TPCD's used for fuel containment so that post-installation operational tests or checks are not required.
		EXT-05	Design access doors for cargo type TPCD's to be non-load carrying and with simple latches for all doors and panels.
		EXT-06	Design cargo TPCD's to ensure all cargo and equipment can be downloaded and uploaded with the TPCD installed on the host vehicle.
		EXTING-01	Use extinguishing concepts dedicated to each individual fire zone in preference to manifold systems operating from a central source.
		EXTING-03	Keep each individual fire zone over-temperature/fire warning system separate from those in other fire zones.
		EXTING-04	Design individual fire zone over-temperature/fire warning system to be fully BIT capable (the BIT concept should permit both initiated and periodic BIT).
		F-01	Use blind fasteners only where absolutely necessary or where considerable cost can be saved.
		F-02	Minimize access fasteners while making them quick release, easily removed and replaced, and captive.
		F-03	Choose fasteners based on the requirement to operate by hand or with common hand tools rather than special tools.
		F-04	Whenever possible, incorporate barrel type fasteners as opposed to hi-torque fasteners. Failure of Hi-torque fasteners due to stripping are common and a source of potential foreign object damage (FOD).
		FUEL-01	Locate fuel vent and dump masts to ensure exiting fuel will be clear of servicing, loading, arming and safing areas for all types of ground and airborne vehicles.
		FUEL-02	Manufacturing splices for major sub-assemblies should not intrude into or through integral fuel cells or tanks.
		FUEL-03	Structural bolts, screws, and fasteners should not penetrate into integral fuel cells or tanks other than those used for access door attachment.
		FUEL-04	Where the fuel wetted area inside a fuel cell or tank is void of blade, knife, and hat stiffeners for use as hardpoint attachment, standoff's bonded to the cell surface should be used as attachments for clamps, and brackets to eliminate fastener penetration of the fuel cavity.
		FUEL-05	Intersecting of two or more surfaces in a fuel wetted area of less than 90 degrees should be avoided to simplify manufacture and repair.
		FUEL-06	Where maintaining a minimum angle of 90 degrees is not possible, sufficient depth, width, and height should be maintained to provide tool clearances for all tools used in the manufacturing processes and in the operational field repair environment.
		FUEL-07	When feed tanks are designed such that the lower portion of the tank serves as a surge chamber, the top closure deck of the surge chamber should provide the strength to support the weight of a 95 percentile male.
		FUEL-08	The size and number of fuel cell and tank access doors should be sufficient to ensure no wetted area of the cell or tank is beyond a maximum 18" distance from the edge of the access opening. This guideline applies to only non-man rated cells.

Guidelines by Category (Cont'd)

Category No.	Category Title	Guideline No.	Guideline
3.03.09	External and Parasitic Tanks, Pods, Containers, and Devices	FUEL-09	All fuel cell or tank access doors not mounted on the exterior surface should contain sealing provisions other than the channel type.
		FUEL-10	Provide access from the wing closure ribs in lieu of the moldline when access is required in close proximity to the wing fold area.
		FUEL-11	Through-the-tank fasteners should not be used for fuel cells or tanks in areas where a leak path could be established into an inaccessible portion of the vehicle.
		LG-02	Hardpoints for attachment of landing gear trunnions should be capable of carrying all induced gear loads for the life of the airframe.
		LG-03	Hardpoints for attachment for landing gear trunnions should not be machined as an integral part of the airframe structure when normal design sink rates over 25 feet per second are required.
		LG-04	Do not use Beryllium and Beryllium base alloys in any location subject to wear or corrosive atmospheres or in installations where machining may be required.
		LG-05	All bolts or similar threaded means used as adjustable stops should be positively retained in the adjusted reference without reliance on jam nuts, cotter pins, or safety wire.
		LG-31	Landing gear doors designed to close after gear is extended should be capable of being manually opened on the ground without reliance on electrical or hydraulic power.
		LG-32	Design of landing gear doors normally closed after gear extension should ensure failure modes will not enable uncommanded opening on the ground.
		LG-35	Avoid the use of landing gear doors to mount or house antennas, arrays, or air data sensors.
		LG-36	Location of integral wheel jack points on a strut should provide a minimum 6-1/2 inch clearance for positioning the jack with tire ruptured and wheel ground 2 inches off ground.
		LG-37	Integral hardpoints to jack the entire vehicle should ensure that identical jacks can be used at all jack points.
		LG-38	All landing gear doors should be interchangeable.
		LG-39	Gear-mounted tie-down or chain-down fittings should be interchangeable and easily replaceable.
		LO-01	Use LO compatible gap fillers for manufactured gaps in lieu of tape and butter (surface coating compound).
		LO-02	Avoid scheduled forced inspections or replacement of materials, coatings, or finishes solely to protect either the reliability or the signature.
		LO-03	Equipment and support structure requiring shrouds to reduce radar returns should not cause increases in equipment service/repair time.
		LO-04	Infrequently-accessed structural doors and panels incorporating special coatings or conductive paints should contain provisions for prying the door or panel clear of moldline with standard screwdriver without damage.
		LO-05	Do not locate flush mounted LO screens for auxiliary air inlets and exits in walkway areas unless durability has been proven.
		LO-06	Size flush mounted LO screens for auxiliary air inlets and exits to ensure functionality with up to 25 percent of the openings plugged.
		LO-07	Flush and non-flush LO screens should be interchangeable.
		MATL-01	A high degree of durability should be maintained for a minimum distance of 36 inches forward of the inflight refueling receptacle.
		MATL-02	Cosmetic type repairs should not exceed 1 hours including cure or drying times.
		MATL-03	Cosmetic and vehicle repair material shelf life should not be less than 24 months.
		MATL-04	Cosmetic and vehicle repair materials should be non-proprietary and non-single source.
		MATL-05	Cosmetic and vehicle repair materials should not require refrigeration or special facilities or atmospheres for storage.
		MATL-11	Coatings and finishes should be durable against the effects of gun gases, projectile shock waves, and brass particles emanating from the projectile seal rings.
		MATL-12	Leading edge materials and coatings should be durable against fragments from frangible gun port plugs.
		MATL-13	Special handling or shipping requirements of repair materials should be avoided.

Guidelines by Category (Cont'd)

Category No.	Category Title	Guideline No.	Guideline
3.03.09	External and Parasitic Tanks, Pods, Containers, and Devices	MATL-14	Leading edges, including chimes, containing or constructed of radar absorbing materials, should be interchangeable to reduce vehicle downtime and simplify repairs.
		MATL-15	Doors and panels containing blade seals used for signature reduction should be interchangeable or contain interchangeable blade seals. Deviation is acceptable where repairs can be accomplished on the vehicle in a time equal to or less than door or seal remove and replace time.
		MC-01	All clamps should contain torque-set or torque-limiting connections to prevent clamp or component failure due to over-torque. Clamp installation call outs should not depend on special tools to establish the required torque values.
		MC-02	Avoid the use of cotter pins, safety wire, safety clips, and similar devices to prevent maintenance-induced events leading to ground vehicle accidents or loss of air vehicles.
		MC-03	All tubing connections and interfaces should use rosan/dynatube (or equivalent) to (1) enable connect or disconnect with one hand, one tool, (2) eliminate the need to safety the connection, (3) provide a superior seal, and (4) negate need to reposition line(s) during component replacement.
		MC-04	No trombone type, flared tube type, or piloted line type interfaces should be used to avoid the need for removal or repositioning during equipment removal.
		MC-05	Avoid potential foreign object traps during manufacturing or operational maintenance by eliminating vertical penetrations of plumbing/fittings into tanks, compartments, or cells
		MC-06	Locate, position, orient all plumbing and duct electrical connectors to prevent the need for sequential installation or removal.
		MC-07	Maximize areas of constant web thickness in firewalls, carry-through bulkheads, major frames, structural ribs, spars, webs, keels, and close-outs to provide flexibility in locating penetration fittings. Stepped chem milling, stepped machining, stepped composite layup concepts all tend to result in minimal available surface area for penetrations.
		MC-08	All in-line plumbing connections within a fuel tank or cell should be capable of making/breaking the interface by hand, require no torque, contain integral safety locking mechanisms, and should be void of any requirement for safety wire.
		MC-09	All plumbing connections and fittings used for fuel systems should contain integral bonding features to eliminate the need for bonding clamps or jumper cables.
		MC-10	In rare instances where a plumbing run contains complex form or geometry that would require removal of other plumbing or equipment for access, in-line connectors should be incorporated to maintain the integrity of other plumbing or equipment.
		MC-11	No subsystem plumbing, equipment, or wiring should use a tank, cell, or compartment containing liquids as a means for routing or penetration simplicity during manufacture.
		MC-12	All plumbing and connectors containing liquids should be meniscus-free.
		MC-13	In instances where plumbing or connector interfaces cannot or are not keyed for a specific orientation, all identification, markings, cautions, and directions should be placed 360 degrees around the tube or duct.
		MC-14	Where multiple connectors are located in close proximity, ensure (1) a minimum hand tool arc of 120 degrees can be maintained, and (2) stagger fittings to ensure firm coupling interface/hand tool interface can be accomplished without inducing damage to adjacent lines.
		MC-15	Route, orient, and position plumbing, wiring, ducts, and connectors sufficiently away from the outer surface of the vehicle to preclude induced damage due to minor dents, drill bits during repair, etc. Minimum rule of thumb is 1" away from the inner surface and 1" below a plate nut channel.
		MP-01	Avoid the use of epoxies to mount parts on repairable modules because they make repair extremely difficult.
		MP-02	Use a unique identification (ID) resistor incorporated in each system module to verify that the proper module is mounted on ATE.
		MP-03	Design modules so that lengthy warm-up times, special coding and air purity levels, and similar constraints are not necessary.
		OXY-05	Locate liquid oxygen (LOX) containers in a sealed, dedicated compartment to eliminate need for frequent visual inspections.

Guidelines by Category (Cont'd)

Category No.	Category Title	Guideline No.	Guideline
3.03.09	External and Parasitic Tanks, Pods, Containers, and Devices	P-01	Access door and panel fastener types for airborne vehicles should meet the following criteria: <ul style="list-style-type: none"> - use latches for a frequency of access of 0 to 40 flight hours - use High Strength Quick Release fasteners for a frequency of access of 40-400 flight hours - use structural screws for a frequency of access of 400 flight hours or more
		P-02	Access door and panel fastener types for surface vehicles should meet the following criteria: <ul style="list-style-type: none"> - use a spring loaded or latch fastener for an opening frequency of daily - use a one quarter turn fastener (or equivalent) for a opening frequency of weekly - use screws or bolts for all other cases
		P-03	All doors and panels subject to environmental elements should contain form-in-place seals (or equivalent) attached to the door structure, not substructure, to prevent damage during maintenance.
		P-04	Door and panel seals should be compatible with all types of on-board servicing fluids, de-ice and anti-ice fluids, and all fluids used for chemical, biological, and nuclear decontamination.
		P-05	Piano type hinges should not be used on doors or panels because they are subject to wear, corrosion, and sand and fluid entry.
		P-06	Access door and panel devices used to support door in opened position should meet the following criteria: <ul style="list-style-type: none"> - for airborne vehicles, design for 60 knot gust loads (or equivalent jet blast loads) - for ground vehicles, design for 50 mph gust loads
		P-07	Hinged access doors and panels capable of remaining in the opened position should not have sharp edges or corners.
		P-08	Removable access door and panel fasteners should be of identical grip length and diameter.
		P-09	Acceptable door and panel hold-open devices include over-center sheet metal spring, over-center spring link, spring cartridge, support strut, and pinned goose neck hinge.
		P-10	Access doors and panels requiring non-captive fasteners should not be located forward of air inlet ducts or high-energy rotating components (e.g., prop fans, engine cooling fans, etc.).
		P-11	Access doors and panels should be interchangeable as justified by operation and support costs or life cycle costs.
		PYRO-06	"Safe/arm" mechanism design should be free from FOD potential.
		PYRO-07	Manual "safe/arm" mechanisms should be well-clear of inlet ducts, propellers, rotors, and similar rotating components.
		PYRO-08	Manual "safe/arm" mechanisms should be well-clear of engine exhausts, fuel/toxic vents, fluid drains, control surface deflection envelopes, and rescue path envelopes.
		PYRO-09	Provide positive, Murphy-proof locking detents for both the "safe" and "arm" positions of mechanical mechanisms.
		PYRO-10	Provide a numerical maintenance code on maintenance panels or maintenance recorder/memory systems to denote the "safe/arm" status for each weapon or store.
		PYRO-11	Design electrical/electronic "safe/arm" systems to eliminate the need for mechanical type system interrupt devices.
		PYRO-12	Design of weapons, flare/chaff packages, and airborne pyrotechnic containers should follow the "wooden round" design concept to eliminate scheduled tests, checks, and inspections throughout its intended life cycle.
		PYRO-13	Container design for shipping, handling, and storing weapons, flares, chaff, and similar devices should not require special atmospheres.
		PYRO-14	Design weapon drop and fire/release circuits with frequency-coded firing systems or similar concepts to ensure stray energy tests and checks will not be required and that stray energy will not impose a safety hazard or problem.
		PYRO-15	Pylon-to-weapon and pylon-to-air vehicle electrical interfaces should contain built-in test/fault location capabilities.
		PYRO-16	Do not use cartridge actuated devices (CADs) for store or weapon ejection or for pylon jettison due to inherent ground safety hazards, stray energy hazards, and scheduled cleaning requirements.
		PYRO-17	In rare instances where use of CADs may be required, a positive indication to denote "cartridge installed" should be provided.
		PYRO-21	Weapon bays should contain internal lighting controlled by a separate switch that is only functional when doors are open.
		PYRO-22	A "rounds remaining" status should be available at the gun loading interface, maintenance panel, or cockpit/crew station/operator station.

Guidelines by Category (Cont'd)

Category No.	Category Title	Guideline No.	Guideline
3.03.09	External and Parasitic Tanks, Pods, Containers, and Devices	PYRO-23	Crew size for full ammo load should not exceed two persons.
		PYRO-24	Ammo loader interface should not be less than 30" nor more than 50" above the ground to ensure loading can be accomplished by a wide range of percentiles wearing chemical or biological protective gear.
		PYRO-25	Gun loading and servicing should be possible concurrently with all other weapon loading and servicing activities to minimize the elapsed downtime.
		PYRO-26	Do not locate ammunition loader interfaces close to inlets, exhausts, fuel dumps and drains, antennas, sensors, lights, or hazardous protrusions.
		PYRO-27	Incorporate integral hoisting provisions at each weapon/store station to enable direct lift from the container or carrier to the attachment hardpoints.
		PYRO-28	Automatic locking of the retention hooks should be accomplished for each respective weapon and store.
		PYRO-29	Provide quick mechanical over-travel (no power) for weapon bay doors to maximize the weapon/store loading envelope.
		PYRO-30	Ensure weapon bay door arc (both normal and over-travel) does not block or intrude into adjacent service points or envelopes.
		PYRO-32	Provide sufficient longitudinal clearance between weapon bays to enable simultaneous loading of two bays.
		PYRO-33	Provide sufficient lateral clearance between weapon bays to enable simultaneous loading of two bays.
		PYRO-34	Weapon bay door seals should be bonded or attached to door structure to minimize induced seal damage during weapon or store loading.
		PYRO-35	Suspension system should permit any single weapon or store to be loaded by a two man crew.
		PYRO-36	Suspension system design and spacing should enable any combination of eight weapons to be loaded by two two-man crews within the refueling time of the vehicle (excludes nuclear weapons).
		PYRO-37	Internal weapon suspension arrangements should preclude sequential weapon loading.
		PYRO-39	Weapon bay ejectors and launchers should have the capability for total interchangeability and reconfigurability.
		PYRO-41	Weapon or store handling and transportation equipment should be compatible with rough terrain and capable of 25 mph towing speeds minimum.
		PYRO-42	In weapons carriage design and integration, avoid dependence of on-board high pressure nitrogen.
		PYRO-43	Launcher or ejector design/interface should not require a dual function of carrying airframe structural loads.
		PYRO-44	Launcher and ejector design should incorporate automatic sway bracing.
		PYRO-45	Missile ejectors should be provided with repeatable missile motor fire wires to simplify loading and reduce elapsed time.
		PYRO-46	Design pylons, launchers, and ejector racks so that weapon loading, servicing, and reconfigurations can be accomplished using standard hand tools.
		PYRO-47	Installation design of ejectors, launchers, racks, and associated hardware interfaces should avoid reliance on torque wrenches.
		SABCH-01	Do not locate auxiliary air inlets, sensors, access doors, or drains in boundary bleed areas.
		SABCH-02	All flush type structural screws should have identical head drives for the entire vehicle.
		SABCH-03	All non-flush type structural screws should have identical head drive recesses for the entire vehicle.
		SABCH-04	Special high strength bolts, such as twelve-point heads, should be fully justified from standpoint of the cost of ownership and effectiveness.
		SABCH-05	Structural design should avoid the reliance on blind fasteners unless fully supported by cost, weight, schedule, and effectiveness analysis.
		SABCH-06	Structural design should avoid the potential of dissimilar material or fastener corrosion.
		SABCH-07	No structural fasteners should be used that require special tools for installation.
		SABCH-08	Taper pins should be threaded and retained with self-locking hardware.
		SABCH-09	Pins and collars (lockbolts) should only be used in applications which do not normally require removal.
		SABCH-10	Do not use lockbolts in composites.

Guidelines by Category (Cont'd)

Category No.	Category Title	Guideline No.	Guideline
3.03.09	External and Parasitic Tanks, Pods, Containers, and Devices	SABCH-11	In rare instances where the use of dissimilar material in immediate contact cannot be avoided, they should be sufficiently insulated to endure for the life of the vehicle.
		SABCH-12	Avoid tapping threads into structural members. Use of heli-coil type or similar insert concepts is permissible.
		SABCH-13	No structural design concept should rely on frequent scheduled inspections to monitor or otherwise ensure structural integrity.
		SABCH-14	No structural fastener intended to carry shear or tension loads should be smaller than 1/4" diameter (.25").
		SABCH-15	Give preference to butt type splices over lap type splices in the design of manufacturing splices.
		SABCH-16	Wing-to-fuselage attachment should give preference to tension ties over shear ties to improve overall volumetric efficiency.
		SABCH-17	Hardpoints for securing tie down chains, cables, and devices during transport should not require reaching under or crawling under the vehicle.
		SABCH-18	Rings, posts, and clevis devices used for attaching tie downs should not require opening of doors or panels for access.
		SABCH-19	Avoid tie down concepts requiring attaching hardpoints as a prerequisite.
		SABCH-20	Location of hardpoints used for tie down attachment should: - Remain outside of door and panel opening envelopes. - Be clear of exhaust pipes, ducts, manifolds, and mufflers. - Be clear of overboard fluid drains and vents.
		SAFE-12	Internal weapon bay doors should contain integral safety locking features for use during maintenance and weapon loading and downloading.
		SAFE-13	It should not be possible to unsafe a weapon bay door integral lock when a door closed signal is present.
		SE-04	Gun port covers or plugs should be lightweight, 100% effective, and easy to install or store.
		SIMP-01	Location and design of all exterior lights should not require protective covers in ground environments.
		SURV-05	Design survival equipment pods intended for external carriage or suspension to meet the same environmental and operational criteria as the host vehicle structure.
		W-01	Hat section type structural stiffeners with sufficient cross sectional area should be considered as a routing tunnel for wiring and coax.
		WBAY-01	Equipment bays and compartments should not require installation of special cavity fillers when equipment is not installed.
		WBAY-02	Pylon-to-wing electrical or plumbing interfaces should have automatic close-out covers when pylon is jettisoned or not installed.
		WBAY-03	The method and position of the pylon-to-wing gap seal should not form a drip edge for leakage into the pylon cavity.
		WBAY-04	The gap treatment should be a permanent installation on the pylon, wing, or both, not a separate seal.
		WBAY-05	Gap treatment should not interfere with or be damaged by existing pylon handling support equipment.
		WBAY-06	Pylon rigging should not be required for gap seal control.
		WBAY-07	Gap seal should not degrade interchangeability of pylon.
		WBAY-08	Gap seal and treatment should be fully compatible with steam from carrier catapults.
		WBAY-09	Gap seal/pylon should not cover or hamper access to low point wing drains.
		WBAY-10	No loose hardware should exist before or after pylon is installed.
		WBAY-11	Gap seal should match pylon and wing/fuselage surface impedance.
		WBAY-12	Pylon-to-store/weapon gap seal should permit visual and physical access during loading for all interfaces between bomb rack-to-store, bomb rack-to-launcher, and launcher-to-store.
		WBAY-13	Pylon-to-store/weapon gap seal should not interfere with automatic sway brace function.
		WBAY-14	Pylon-to-store/weapon gap seal should permit physical access to lanyards.
		WBAY-15	Gap seals should not hinder pilot or ground crew preflight inspection.
		WBAY-16	Gap seals should not degrade loading while wearing arctic or chemical, biological, or radiation protective clothing.

Guidelines by Category (Cont'd)

Category No.	Category Title	Guideline No.	Guideline
3.03.09	External and Parasitic Tanks, Pods, Containers, and Devices	WBAY-17	Special coatings or conductive paints on pylons, launchers, racks, launchers, tanks, pods, etc. should have the durability to withstand contact with support stands/cradles during storage.
		WBAY-18	The proximity of the gun firing barrel to structure should be such that structural furrows or channels are not required for projectile clearances during firing.
		WBAY-21	Coatings and finishes in the area of gun barrels should be durable to withstand the effect of exiting projectile shockwaves.
		WBAY-22	The proximity of the gun blast deflector to structure should not require reliance on high-temperature paints or coatings to protect the structure.
		WIND-01	Optical window materials should be scratch resistant, easy to clean, and dissipate electrostatic charges.
		WIND-02	Optic windows should be located for ease of inspection, cleaning, and induced damage potential from personnel or support equipment.
		WIND-03	Window locations should minimize the effects of contamination by salt spray, bugs, oils, fuels, and icing.
		WIND-04	Window, canopy, and windshield material should be designed to withstand the effects of sandstorms in the ground environment and the effects of rain and hail during thunderstorm penetration in the airborne environment.
		WIND-05	Design interior surfaces to be reachable for cleaning without reliance on hinging, equipment removal, or use of support equipment.
		WIND-06	Do not locate windows in the proximity of rooster tails created by wheels/tires passing through water or slush.
		WIND-07	Use materials that are highly resistive to thermal shock.
		WIND-11	For dome-shaped optic window concepts, the dome should be easily removable for cleaning without affecting LO integrity.
		WIND-12	Design EO windows and optics to be interchangeable among the same air vehicle types or same ground vehicle types.
		WIND-13	The combination of material layers and coatings for optics and windows should be such that static charge buildup for worst case conditions should not exceed 10,000 volts.
		WIND-14	Exterior lights should permit simple and rapid bulb replacement without disturbing LO treatments.
		WIND-15	Design light covers and lenses to be sufficiently durable so that protective covers are not needed during maintenance.
		WIND-16	Lens shape should enhance LO capability to reduce need, care, and expense for special coatings.
3.03.10	Personnel Seats (Crew and Passenger), Ejection Seats, Benches, and Chairs	A-06	Hardpoints (structural attachment and load bearing areas) within a compartment to assist in equipment mounting or support should not be integral with the machined part. Hardpoints should be parasitic to enable quick repair in case of wear or damage in lieu of precise ream/bush repair typical of machined hardpoints.
		A-13	Two-sided or two-surfaced access should not be required for access to equipment interfaces and hardpoints. The term two-sided infers top/bottom, left/right, front/back, or combinations thereof.
		BIT-06	Mission critical functions should be monitored by BIT.
		BIT-09	Use concurrent BIT to monitor system critical functions.
		BIT-26	Locate routinely used test points so they are accessible without removing or disassembling other equipment
		CONT-01	Control rods should use Boyd or impedance type bolts (or equivalent) to eliminate the need for cotter pins or safety wire.
		CONT-02	Do not use metal control cables for vehicles that will operate in salt water or salt air environments.
		CONT-03	Use control rods rather than control cables for non-complex applications and non-complex routing within the vehicle.
		CONT-04	Use control cables rather than control rods for most complex applications.
		CONT-05	Route cables so that 100 percent of a cable will be viewable for inspection.
		CONT-06	Design all pulleys and brackets associated with cable installations so they are accessible by a 75 percentile male hand.
		D&V-01	The geometric aspects of structural design and interfaces should not result in any natural bathtubs.
		D&V-02	Closed structural sections subject to condensation or fluid migration should contain drainage provisions.
		D&V-03	Crew cabs, operators' compartments, crew stations, cockpits, and passenger compartments should be subject to the same corrosion prevention measures as the exteriors of the vehicles. Low points, pockets, and related fluid collection points within should be provided with low point drains.

Guidelines by Category (Cont'd)

Category No.	Category Title	Guideline No.	Guideline
3.03.10	Personnel Seats (Crew and Passenger), Ejection Seats, Benches, and Chairs	LG-05	All bolts or similar threaded means used as adjustable stops should be positively retained in the adjusted reference without reliance on jam nuts, cotter pins, or safety wire.
		MC-01	All clamps should contain torque-set or torque-limiting connections to prevent clamp or component failure due to over-torque. Clamp installation call outs should not depend on special tools to establish the required torque values.
		MC-02	Avoid the use of cotter pins, safety wire, safety clips, and similar devices to prevent maintenance-induced events leading to ground vehicle accidents or loss of air vehicles.
		MC-03	All tubing connections and interfaces should use rosan/dynatube (or equivalent) to (1) enable connect or disconnect with one hand, one tool, (2) eliminate the need to safety the connection, (3) provide a superior seal, and (4) negate need to reposition line(s) during component replacement.
		MC-04	No trombone type, flared tube type, or piloted line type interfaces should be used to avoid the need for removal or repositioning during equipment removal.
		MC-05	Avoid potential foreign object traps during manufacturing or operational maintenance by eliminating vertical penetrations of plumbing/fittings into tanks, compartments, or cells
		MC-06	Locate, position, orient all plumbing and duct electrical connectors to prevent the need for sequential installation or removal.
		MC-09	All plumbing connections and fittings used for fuel systems should contain integral bonding features to eliminate the need for bonding clamps or jumper cables.
		MC-11	No subsystem plumbing, equipment, or wiring should use a tank, cell, or compartment containing liquids as a means for routing or penetration simplicity during manufacture.
		MC-12	All plumbing and connectors containing liquids should be meniscus-free.
		MC-13	In instances where plumbing or connector interfaces cannot or are not keyed for a specific orientation, all identification, markings, cautions, and directions should be placed 360 degrees around the tube or duct.
		MC-14	Where multiple connectors are located in close proximity, ensure (1) a minimum hand tool arc of 120 degrees can be maintained, and (2) stagger fittings to ensure firm coupling interface/hand tool interface can be accomplished without inducing damage to adjacent lines.
		MP-01	Avoid the use epoxies to mount parts on repairable modules because they make repair extremely difficult.
		MP-02	Use a unique identification (ID) resistor incorporated in each system module to verify that the proper module is mounted on ATE.
		MP-03	Design modules so that lengthy warm-up times, special coding and air purity levels, and similar constraints are not necessary.
		SABCH-21	Tire pressure reduction should not be required prior to tie down solely to increase the tire footprint
		SAFE-08	A single lever safety should, when positioned, safe the entire escape/ejection system. Use of the single lever to "arm" should require two hands.
		SAFE-09	Safing the canopy jettison system should be accomplished through the same lever device used to safe the ejection seat.
		SEAT-01	Design personnel seats and padding materials, including the covers and fillers, so they are incapable of creating or emitting toxic fumes or dense smoke when subjected to fire.
		SEAT-02	Design personnel seats and padding materials so they are incapable of absorbing and holding fluids.
		SEAT-03	Do not use seat and padding materials that can create static electricity in pyrotechnic or combustible fluid environments.
		SEAT-04	Design ejection seats so they can be replaced with canopy or escape hatch installed.
		SEAT-05	Design ejection seat pyrotechnic devices so they are 100 percent viewable and accessible with seat installed.
		SEAT-06	Do not use seat removal as a means of access.
		SIMP-01	Location and design of all exterior lights should not require protective covers in ground environments.
		SURV-02	Provide crew stations, crew compartments, and operator areas containing dinghies as emergency equipment with a suitable tool for puncturing or cutting the dinghy in the event of inadvertent inflation. Locate the tool so that access is assured during dinghy inflation.

Guidelines by Category (Cont'd)

Category No.	Category Title	Guideline No.	Guideline
3.03.11	Materials, Treatments, Coatings, and Finishes	A-01	Seal equipment bays and compartments against the environmental elements including all types of servicing fluids used for the vehicle, all types of anti-ice and de-ice fluids, and all types of fluids used for chemical, biological, or nuclear decontamination.
		A-02	Equipment bay and compartment structure should be bonded, co-cured, welded, machined, or combinations thereof to eliminate or minimize the use of mechanical fasteners.
		A-03	All equipment bay and compartment structural flanges and stiffeners should be external to the compartment to maximize the volume available for equipment installation and arrangement.
		A-04	Use stiffening beads in lieu of flanges to the maximum extent to enhance compartment volume and simplify repairs.
		A-05	Stiffening beads should have the convex surface toward the compartment to eliminate fluid traps.
		A-16	Keep all machined compartment frames, webs, and closure panels to a constant thickness (e.g., not stepped or tapered) to ease simplicity of fluid or electrical penetrations and ease and simplicity of structural repair.
		CREW-07	Structural design should provide good access to corrosion-prone areas for inspection and treatment.
		CREW-08	Electronic and photosensitive storage media should withstand the adverse environment created by ground, flightline, or shipboard electromagnetic fields and light sources.
		D&V-03	Data storage media containers and modules should be capable of chemical and biological decontamination processes.
		ECS-18	Crew cabs, operators' compartments, crew stations, cockpits, and passenger compartments should be subject to the same corrosion prevention measures as the exteriors of the vehicles. Low points, pockets, and related fluid collection points within should be provided with low point drains.
		ECS-19	Avoid the use of insulation blankets containing polyvinyl for any application due to the dense smoke and toxic fumes if burned or subjected to high temperature bleed air leakage.
		ECS-20	Thermal blankets and covers used in ground vehicle thermal blankets and covers should be capable of being repaired in place.
		ECS-25	Minor rips, tears, and punctures in ground vehicle thermal blankets and covers should be replaceable.
		ENG(G)-16	Technology, material selection, and treatments should combine to provide a corrosion-resistant system.
		ENG(G)-19	Do not locate batteries in the engine compartment. In those instances where this is not possible:
		ENG-47	- The battery support structure should be of a material that is impervious to acid leakage or boil-over.
		ENV-01	- The battery support structure should serve as a scupper to collect and direct the acid out of the engine compartment.
		ENV-02	Paint engine compartments gloss white to enhance light reflectivity and enhance fluid leak detection.
		ENV-03	Design the engine, including all accessories, plumbing, wiring, ducts, and mechanisms, to meet the same environmental protection and compatibility requirements as the host vehicle.
		ENV-04	Materials, treatments, coatings, finishes should be compatible with all anti-ice and de-ice fluids, chemical and biological decontamination fluids, washing and cleaning fluids, and all vehicle subsystem fluids.
		ENV-05	There should be no top coat or treatment deterioration throughout the standard temperature and humidity spectrum.
		EXH-01	For airborne vehicles, the finishes should be durable against rain, hail, and dynamic erosion throughout the flight envelope.
		EXH-02	For airborne and ground vehicles, the finishes should be durable against sand erosion throughout all surface wind speeds experienced in arid or desert geographical locations.
		IN(V)-08	For airborne vehicles, materials and all finishes with the engine inlet should be durable against hammer shock and compressor stalls.
		IN-01	Treatments required for engine hot sections and exhaust areas should not require scheduled removals for the purposes of recoating.
			High temperature exhaust patterns should flow away from or be directed away from treated surrounding structure, coatings, or finishes.
			Incorporate an inlet closure door sealing concept that prevents entry of fluid, dust, or sand across the entire airborne and ground environment spectrum.
			Low Observable (LO) engine face frames should be within 10 inches of the first stage fan or compressor blades.

Guidelines by Category (Cont'd)

Category No.	Category Title	Guideline No.	Guideline
3.03.11	Materials, Treatments, Coatings, and Finishes	IN-02	Openings throughout the engine face frame should be sufficient to perform a 100% FOD inspection of the engine face.
		IN-03	Openings throughout the engine face frame should be sufficient to permit minor blending or repair of FOD without removing the engine.
		IN-04	For frames not integral with the engine, frame removal should be achievable from the engine cavity.
		IN-05	Both integral and remote engine front frames should be interchangeable.
		IN-06	Front frame anti-ice and de-ice provisions should give preference to engine hot bleed air.
		LG-04	Do not use Beryllium and Beryllium base alloys in any location subject to wear or corrosive atmospheres or in installations where machining may be required.
		LO-01	Use LO compatible gap fillers for manufactured gaps in lieu of tape and butter (surface coating compound).
		LO-02	Avoid scheduled forced inspections or replacement of materials, coatings, or finishes solely to protect either the reliability or the signature.
		LO-03	Equipment and support structure requiring shrouds to reduce radar returns should not cause increases in equipment service/repair time.
		LO-04	Infrequently-accessed structural doors and panels incorporating special coatings or conductive paints should contain provisions for prying the door or panel clear of moldline with standard screwdriver without damage.
		LO-05	Do not locate flush mounted LO screens for auxiliary air inlets and exits in walkway areas unless durability has been proven.
		LO-06	Size flush mounted LO screens for auxiliary air inlets and exits to ensure functionality with up to 25 percent of the openings plugged.
		LO-07	Flush and non-flush LO screens should be interchangeable.
		MATL-01	A high degree of durability should be maintained for a minimum distance of 36 inches forward of the inflight refueling receptacle.
		MATL-02	Cosmetic type repairs should not exceed 1 hours including cure or drying times.
		MATL-03	Cosmetic and vehicle repair material shelf life should not be less than 24 months.
		MATL-04	Cosmetic and vehicle repair materials should be non-proprietary and non-single source.
		MATL-05	Cosmetic and vehicle repair materials should not require refrigeration or special facilities or atmospheres for storage.
		MATL-06	Repair criteria, repairs, and instructions should not be classified.
		MATL-07	All cosmetic touch-up and repair materials should be environmentally safe.
		MATL-08	Repairs (other than major depot repair) should not require autoclave type facilities.
		MATL-09	A high degree of durability should be achieved across all walkway areas on the top surfaces of all vehicles up to and including 95 percentile personnel.
		MATL-10	Coatings and finishes should be durable against the effects of missile gases, velocities, and particles emanating from the missile motor.
		MATL-11	Coatings and finishes should be durable against the effects of gun gases, projectile shock waves, and brass particles emanating from the projectile seal rings.
		MATL-12	Leading edge materials and coatings should be durable against fragments from frangible gun port plugs.
		MATL-13	Special handling or shipping requirements of repair materials should be avoided.
		MATL-14	Leading edges, including chimes, containing or constructed of radar absorbing materials, should be interchangeable to reduce vehicle downtime and simplify repairs.
		MATL-15	Doors and panels containing blade seals used for signature reduction should be interchangeable or contain interchangeable blade seals. Deviation is acceptable where repairs can be accomplished on the vehicle in a time equal to or less than door or seal remove and replace time.
		P-03	All doors and panels subject to environmental elements should contain form-in-place seals (or equivalent) attached to the door structure, not substructure, to prevent damage during maintenance.

Guidelines by Category (Cont'd)

Category No.	Category Title	Guideline No.	Guideline
3.03.11	Materials, Treatments, Coatings, and Finishes	P-04	Door and panel seals should be compatible with all types of on-board servicing fluids, de-ice and anti-ice fluids, and all fluids used for chemical, biological, and nuclear decontamination.
		P-05	Piano type hinges should not be used on doors or panels because they are subject to wear, corrosion, and sand and fluid entry.
		SABCH-06	Structural design should avoid the potential of dissimilar material or fastener corrosion.
		SABCH-10	Do not use lockbolts in composites.
		SABCH-11	In rare instances where the use of dissimilar material in immediate contact cannot be avoided, they should be sufficiently insulated to endure for the life of the vehicle.
		SE-01	Wheel chocks for all types of ground and airborne vehicles should contain the following features: <ul style="list-style-type: none"> - Be nestable for low volume during storage or transport - Be manufactured from corrosion-resistant materials - Be releasable from tire pinch - Be highly visible for day and night operations - Be impervious to all types of fluids used to service or maintain the vehicles - Be of light weight
		SE-02	Wheel chocks for airborne vehicles should also contain the following features: <ul style="list-style-type: none"> - Contain provisions for securing to ramp or flight decks - Contain provisions to secure chocks at wheels - Releasable/removable from outside of hot brake envelope - Contain provisions to enable chock to be used as a tire blowout device - Contain provisions to prevent skidding on snow or ice
		SE-06	Non-metallic materials should take preference over metals to enable simple manufacturing and repair by bonding in lieu of weldments and/or mechanical fasteners.
		SE-07	The design construction concept and material selection for support equipment structure should not rely or depend upon the use of scheduled maintenance, NDI, or NDT to protect the durability or integrity of the equipment in the operational environment.
		SE-09	Ladders and workstands used in close proximity to air and ground vehicles should contain effective buffers to protect finishes and treatments.
		SE-10	Protective finishes and coatings should meet the same ground environmental criteria as defined for air and ground vehicles.
		SEAT-01	Design personnel seats and padding materials, including the covers and fillers, so they are incapable of creating or emitting toxic fumes or dense smoke when subjected to fire.
		SEAT-02	Design personnel seats and padding materials so they are incapable of absorbing and holding fluids.
		SEAT-03	Do not use seat and padding materials that can create static electricity in pyrotechnic or combustible fluid environments.
		SIMP-01	Location and design of all exterior lights should not require protective covers in ground environments.
		SKID-01	Design non-metallic floats to be impervious to all fluids used on board the host vehicle.
		SKID-02	Design non-metallic floats to be highly resistant to scuffing and abrasion.
		SKID-03	Design non-metallic floats with a color-coded inner ply to readily denote when maximum abrasion limits have been reached.
		SKID-05	Design metallic and composite floats and skids to the same environmental criteria as the airframe, including finishes.
		SKID-06	Use non-skid finishes on the upper surfaces of skids and floats for use as steps and walkways.
		SKID-07	Design floats with simple drain provisions for each compartment.
		WBAY-01	Equipment bays and compartments should not require installation of special cavity fillers when equipment is not installed.
		WBAY-03	The method and position of the pylon-to-wing gap seal should not form a drip edge for leakage into the pylon cavity.
		WBAY-04	The gap treatment should be a permanent installation on the pylon, wing, or both, not a separate seal.
		WBAY-05	Gap treatment should not interfere with or be damaged by existing pylon handling support equipment.
		WBAY-11	Gap seal should match pylon and wing/fuselage surface impedance.

MIL-HDBK-470A

APPENDIX C

Guidelines by Category (Cont'd)

Category No.	Category Title	Guideline No.	Guideline
3.03.11	Materials, Treatments, Coatings, and Finishes	WBAY-12	Pylon-to-store/weapon gap seal should permit visual and physical access during loading for all interfaces between bomb rack-to-store, bomb rack-to-launcher, and launcher-to-store.
		WBAY-13	Pylon-to-store/weapon gap seal should not interfere with automatic sway brace function.
		WBAY-14	Pylon-to-store/weapon gap seal should permit physical access to lanyards.
		WBAY-15	Gap seals should not hinder pilot or ground crew preflight inspection.
		WBAY-17	Special coatings or conductive paints on pylons, launchers, racks, launchers, tanks, pods, etc. should have the durability to withstand contact with support stands/cradles during storage.
		WBAY-18	The proximity of the gun firing barrel to structure should be such that structural furrows or channels are not required for projectile clearances during firing.
		WBAY-20	Gun plugs required solely to maintain a given signature level should be capable of on-board stowage for use only when a threat requires their presence.
		WBAY-21	Coatings and finishes in the area of gun barrels should be durable to withstand the effect of exiting projectile shockwaves.
		WBAY-22	The proximity of the gun blast deflector to structure should not require reliance on high-temperature paints or coatings to protect the structure.
		WIND-01	Optical window materials should be scratch resistant, easy to clean, and dissipate electrostatic charges.
		WIND-03	Window locations should minimize the effects of contamination by salt spray, bugs, oils, fuels, and icing.
		WIND-04	Window, canopy, and windshield material should be designed to withstand the effects of sandstorms in the ground environment and the effects of rain and hail during thunderstorm penetration in the airborne environment.
		WIND-06	Do not locate windows in the proximity of rooster tails created by wheels/tires passing through water or slush.
		WIND-07	Use materials that are highly resistive to thermal shock.
		WIND-12	Design EO windows and optics to be interchangeable among the same air vehicle types or same ground vehicle types.
		WIND-15	Design light covers and lenses to be sufficiently durable so that protective covers are not needed during maintenance.
		WIND-16	Lens shape should enhance LO capability to reduce need, care, and expense for special coatings.
3.04	Control	A-13	Two-sided or two-surfaced access should not be required for access to equipment interfaces and hardpoints. The term two-sided infers top/bottom, left/right, front/back, or combinations thereof.
		BIT-26	Locate routinely used test points so they are accessible without removing or disassembling other equipment
		CONT-01	Control rods should use Boyd or impedance type bolts (or equivalent) to eliminate the need for cotter pins or safety wire.
		CONT-02	Do not use metal control cables for vehicles that will operate in salt water or salt air environments.
		CONT-03	Use control rods rather than control cables for non-complex applications and non-complex routing within the vehicle.
		CONT-04	Use control cables rather than control rods for most complex applications.
		CONT-05	Route cables so that 100 percent of a cable will be viewable for inspection.
		CONT-06	Design all pulleys and brackets associated with cable installations so they are accessible by a 75 percentile male hand.
		ECS-09	The power actuation source used for valves that direct or control air, gas, or liquid flow should be parasitic to the valve body to enable replacement without disturbing the integrity of the lines, ducts, or plenums.
		ECS-10	Provide hydraulic devices used in critical applications with integral 5 micron filtering.
		HYD-09	Design flexible hose with molded-in color bands to clearly indicate when the maximum wear/abrasion has been reached.
		HYD-11	All bolts or similar threaded means used as adjustable stops should be positively retained in the adjusted reference without reliance on jam nuts, cotter pins, or safety wire.
		LG-05	All microswitches, proximity switches, lights, sensors, etc. mounted to a strut should have individual interface connectors.
		LG-11	Wiring pigtailed requiring in-line splices should be avoided.
		LG-14	All interfaces from the airframe to the struts should be visible and accessible, and not require removal of airframe structure for access.
		MC-02	Avoid the use of cotter pins, safety wire, safety clips, and similar devices to prevent maintenance-induced events leading to ground vehicle accidents or loss of air vehicles.

Guidelines by Category (Cont'd)

Category No.	Category Title	Guideline No.	Guideline
3.04	Control	MC-03	All tubing connections and interfaces should use rosan/dynatube (or equivalent) to (1) enable connect or disconnect with one hand, one tool, (2) eliminate the need to safety the connection, (3) provide a superior seal, and (4) negate need to reposition line(s) during component replacement.
		MC-04	No trombone type, flared tube type, or piloted line type interfaces should be used to avoid the need for removal or repositioning during equipment removal.
		MC-05	Avoid potential foreign object traps during manufacturing or operational maintenance by eliminating vertical penetrations of plumbing/fittings into tanks, compartments, or cells
		MC-06	Locate, position, orient all plumbing and duct electrical connectors to prevent the need for sequential installation or removal.
		MC-09	All plumbing connections and fittings used for fuel systems should contain integral bonding features to eliminate the need for bonding clamps or jumper cables.
		MC-10	In rare instances where a plumbing run contains complex form or geometry that would require removal of other plumbing or equipment for access, in-line connectors should be incorporated to maintain the integrity of other plumbing or equipment.
		MC-11	No subsystem plumbing, equipment, or wiring should use a tank, cell, or compartment containing liquids as a means for routing or penetration simplicity during manufacture.
		MC-12	All plumbing and connectors containing liquids should be meniscus-free.
		MC-13	In instances where plumbing or connector interfaces cannot or are not keyed for a specific orientation, all identification, markings, cautions, and directions should be placed 360 degrees around the tube or duct.
		MC-14	Where multiple connectors are located in close proximity, ensure (1) a minimum hand tool arc of 120 degrees can be maintained, and (2) stagger fittings to ensure firm coupling interface/hand tool interface can be accomplished without inducing damage to adjacent lines.
		MP-01	Avoid the use epoxies to mount parts on repairable modules because they make repair extremely difficult.
		MP-02	Use a unique identification (ID) resistor incorporated in each system module to verify that the proper module is mounted on ATE.
		MP-03	Design modules so that lengthy warm-up times, special coding and air purity levels, and similar constraints are not necessary.
		T-01	Do not locate pyro, gas, and air (PGA) control system exhaust exits: <ul style="list-style-type: none"> - In proximity to safe, arm, or servicing areas, - Adjacent to auxiliary inlets, - In close proximity to crew boarding areas, weapons, emergency ingress/egress areas, and optics or optical glass. Design pyro type thruster exits associated with emergency use or backup with simple exit closure devices to identify if a thruster has been fired.
T-02	Provide protective screens for PGA exits that normally remain open to prevent intrusions from fowl or wildlife.		
T-03	Provide protective closure provisions for PGA exits located or oriented to exposure from the elements.		
T-04	Design single-shot (one time use) type thrusters with a minimum 6-year shelf life and a 7-year installed life.		
T-05	Hardpoints (structural attachment and load bearing areas) within a compartment to assist in equipment mounting or support should not be integral with the machined part. Hardpoints should be parasitic to enable quick repair in case of wear or damage in lieu of precise ream/bush repair typical of machined hardpoints.		
A-06	Two-sided or two-surfaced access should not be required for access to equipment interfaces and hardpoints. The term two-sided infers top/bottom, left/right, front/back, or combinations thereof.		
A-13	During design of the BIT, use worst-case stress analysis to ensure that any circuit failures induced by temperature extremes, tolerance build-up, power supply variations, and combinations thereof are identified.		
BIT-01	Ensure that BIT system thresholds are consistent with those across the system, subsystem, item, module, and piece-part levels to prevent excessive numbers of Cannot Duplicate (CND) and Retest OK (RTOK) events from occurring.		
BIT-02	The degree of BIT required or proposed should be based on the respective failure rates and the appropriate FMECA at all equipment indenture levels.		
BIT-03			
3.04.01	Steering and Directional Control		

Guidelines by Category (Cont'd)

Category No.	Category Title	Guideline No.	Guideline
3.04.01	Steering and Directional Control	BIT-04	Limit the amount of data that is recorded to a manageable size by: <ul style="list-style-type: none"> - Limiting the number of signals that are monitored - Limiting the maximum sampling rate - Reducing the time span over which data is accumulated - Restricting the type of data accumulated
		BIT-05	Incorporate testability design features as an integral part of equipment preliminary design process.
		BIT-06	Mission critical functions should be monitored by BIT.
		BIT-09	Use concurrent BIT to monitor system critical functions.
		BIT-26	Locate routinely used test points so they are accessible without removing or disassembling other equipment
		CONT-01	Control rods should use Boyd or impedance type bolts (or equivalent) to eliminate the need for cotter pins or safety wire.
		CONT-02	Do not use metal control cables for vehicles that will operate in salt water or salt air environments.
		CONT-03	Use control rods rather than control cables for non-complex applications and non-complex routing within the vehicle.
		CONT-04	Use control cables rather than control rods for most complex applications.
		CONT-05	Route cables so that 100 percent of a cable will be viewable for inspection.
		CONT-06	Design all pulleys and brackets associated with cable installations so they are accessible by a 75 percentile male hand.
		ENG(G)-20	Design all firewall fittings, connectors, and penetrations to be fully viewable and directly accessible to the maintainers.
		ENV-06	For ground vehicles, the finishes should be compatible with and durable against all rain, hail, sleet, snow, and ice conditions experienced in all intended operational environments.
		HYD-09	Provide hydraulic devices used in critical applications with integral 5 micron filtering.
		HYD-11	Design flexible hose with molded-in color bands to clearly indicate when the maximum wear/abrasion has been reached.
		LG-01	Bearings, excluding wheel bearings, should not require lubrication during the expected life of the air vehicle airframe.
		LG-04	Do not use Beryllium and Beryllium base alloys in any location subject to wear or corrosive atmospheres or in installations where machining may be required.
		LG-05	All bolts or similar threaded means used as adjustable stops should be positively retained in the adjusted reference without reliance on jam nuts, cotter pins, or safety wire.
		LG-11	All microswitches, proximity switches, lights, sensors, etc. mounted to a strut should have individual interface connectors.
		LG-14	Wiring pigtailed requiring in-line splices should be avoided.
		MC-02	All interfaces from the airframe to the struts should be visible and accessible, and not require removal of airframe structure for access.
		MC-03	Avoid the use of cotter pins, safety wire, safety clips, and similar devices to prevent maintenance-induced events leading to ground vehicle accidents or loss of air vehicles.
		MC-04	All tubing connections and interfaces should use rosan/dynatube (or equivalent) to (1) enable connect or disconnect with one hand, one tool, (2) eliminate the need to safety the connection, (3) provide a superior seal, and (4) negate need to reposition line(s) during component replacement.
		MC-05	No trombone type, flared tube type, or piloted line type interfaces should be used to avoid the need for removal or repositioning during equipment removal.
		MC-06	Avoid potential foreign object traps during manufacturing or operational maintenance by eliminating vertical penetrations of plumbing/fittings into tanks, compartments, or cells.
		MC-09	Locate, position, orient all plumbing and duct electrical connectors to prevent the need for sequential installation or removal.
		MC-10	All plumbing connections and fittings used for fuel systems should contain integral bonding features to eliminate the need for bonding clamps or jumper cables.
			In rare instances where a plumbing run contains complex form or geometry that would require removal of other plumbing or equipment for access, in-line connectors should be incorporated to maintain the integrity of other plumbing or equipment.

MIL-HDBK-470A

APPENDIX C

Guidelines by Category (Cont'd)

Category No.	Category Title	Guideline No.	Guideline
3.04.01	Steering and Directional Control	MC-11	No subsystem plumbing, equipment, or wiring should use a tank, cell, or compartment containing liquids as a means for routing or penetration simplicity during manufacture.
		MC-12	All plumbing and connectors containing liquids should be meniscus-free.
		MC-13	In instances where plumbing or connector interfaces cannot or are not keyed for a specific orientation, all identification, markings, cautions, and directions should be placed 360 degrees around the tube or duct.
		MC-14	Where multiple connectors are located in close proximity, ensure (1) a minimum hand tool arc of 120 degrees can be maintained, and (2) stagger fittings to ensure firm coupling interface/hand tool interface can be accomplished without inducing damage to adjacent lines.
		MP-01	Avoid the use of epoxies to mount parts on repairable modules because they make repair extremely difficult.
		MP-02	Use a unique identification (ID) resistor incorporated in each system module to verify that the proper module is mounted on ATE.
		MP-03	Design modules so that lengthy warm-up times, special coding and air purity levels, and similar constraints are not necessary.
		T-01	Do not locate pyro, gas, and air (PGA) control system exhaust exits: <ul style="list-style-type: none"> - In proximity to safe, arm, or servicing areas, - Adjacent to auxiliary inlets, - In close proximity to crew boarding areas, weapons, emergency ingress/egress areas, and optics or optical glass.
		T-02	Design pyro type thruster exits associated with emergency use or backup with simple exit closure devices to identify if a thruster has been fired.
		T-03	Provide protective screens for PGA exits that normally remain open to prevent intrusions from fowl or wildlife.
T-04	Provide protective closure provisions for PGA exits located or oriented to exposure from the elements.		
WT&B-02	Brake-wear indicating pins should be highly visible during day and night operations.		
WT&B-06	Locate brake anti-skid system components, including brake control valves, for easy access in low-vibration environments.		
WT&B-09	Brake clips, end plates, retainers, etc. used to build up wheel, tire, and brake assemblies should not be capable of reverse or improper installation.		
WT&B-10	No hubcaps or covers should be installed in a manner that prevents full visual viewing of the wheel retaining nut. In instances where this may not be possible, the design should ensure that the hubcap/cover cannot be installed unless the retaining nut is properly installed.		
3.04.02	Flight Control Systems and Air Cushion Systems	A-06	Hardpoints (structural attachment and load bearing areas) within a compartment to assist in equipment mounting or support should not be integral with the machined part. Hardpoints should be parasitic to enable quick repair in case of wear or damage in lieu of precise ream/bush repair typical of machined hardpoints.
		A-13	Two-sided or two-surfaced access should not be required for access to equipment interfaces and hardpoints. The term two-sided infers top/bottom, left/right, front/back, or combinations thereof.
		AA&S-05	Multi-function antennas, arrays, and sensors located in leading edges should be modularized to reduce vehicle downtime through simplified replacement of a faulty module.
		AA&S-06	Moveable flaps or slats containing integral antennas, arrays, or sensors should be interchangeable to provide the option for on-vehicle or off-vehicle repair.
		ACS-01	Design air cushion skirt surfaces to be highly resistant to high velocity blowing sand and stones.
		ACS-02	Design skirt surfaces to the same operational and environmental criteria as that identified for low observable surfaces.
		ACS-03	Select materials for the skirt surface so that bonded repairs can be used for punctures and tears across a wide temperature spectrum/humidity index without relying on special facilities or equipment.
		ACS-04	Incorporate rip-stop methodology in skirt construction to limit tears and rips and to prevent tear propagation.
		ACS-05	Incorporate a color-coded interply in skirts to readily identify the maximum abrasion limit.
		ACS-06	Do not try to achieve high reliability by requiring frequent visual inspections or scheduled replacement at predetermined calendar or operating hour intervals.

Guidelines by Category (Cont'd)

Category No.	Category Title	Guideline No.	Guideline
3.04.02	Flight Control Systems and Air Cushion Systems	ACS-07	Design skirt repair kits and select materials for the kits so they are not subject to a predetermined shelf-life or special storage requirements.
		ACS-08	Design all elements making up the air cushion control system so they are capable of sustained operations in salt air/water environments.
		ACS-09	Employ control by wire or control by light technology to eliminate complex control mechanisms and associated maintenance and support.
		ACS-10	Ensure all diagnostic and prognostic logic, intelligence, and status type informational data are storable and viewable within the crew station.
		ACS-11	Provide crew station personnel with the capability to manually initiate selective BIT and interrogate the prognostics system without interrupting the full-time or periodic BIT routines.
		BIT-01	During design of the BIT, use worst-case stress analysis to ensure that any circuit failures induced by temperature extremes, tolerance build-up, power supply variations, and combinations thereof are identified.
		BIT-02	Ensure that BIT system thresholds are consistent with those across the system, subsystem, item, module, and piece-part levels to prevent excessive numbers of Cannot Duplicate (CND) and Retest OK (RTOK) events from occurring.
		BIT-03	The degree of BIT required or proposed should be based on the respective failure rates and the appropriate FMECA at all equipment indenture levels.
		BIT-04	Limit the amount of data that is recorded to a manageable size by: <ul style="list-style-type: none"> - Limiting the number of signals that are monitored - Limiting the maximum sampling rate - Reducing the time span over which data is accumulated - Restricting the type of data accumulated
		BIT-05	Incorporate testability design features as an integral part of equipment preliminary design process.
		BIT-06	Mission critical functions should be monitored by BIT.
		BIT-09	Use concurrent BIT to monitor system critical functions.
		BIT-26	Locate routinely used test points so they are accessible without removing or disassembling other equipment
		CONT-01	Control rods should use Boyd or impedance type bolts (or equivalent) to eliminate the need for cotter pins or safety wire.
		CONT-02	Do not use metal control cables for vehicles that will operate in salt water or salt air environments.
		CONT-03	Use control rods rather than control cables for non-complex applications and non-complex routing within the vehicle.
		CONT-04	Use control cables rather than control rods for most complex applications.
		CONT-05	Route cables so that 100 percent of a cable will be viewable for inspection.
		CONT-06	Design all pulleys and brackets associated with cable installations so they are accessible by a 75 percentile male hand.
		ENV-01	Materials, treatments, coatings, finishes should be compatible with all anti-ice and de-ice fluids, chemical and biological decontamination fluids, washing and cleaning fluids, and all vehicle subsystem fluids.
		ENV-02	There should be no top coat or treatment deterioration throughout the standard temperature and humidity spectrum.
		ENV-03	For airborne vehicles, the finishes should be durable against rain, hail, and dynamic erosion throughout the flight envelope.
		ENV-04	For airborne and ground vehicles, the finishes should be durable against sand erosion throughout all surface wind speeds experienced in arid or desert geographical locations.
		HYD-09	Provide hydraulic devices used in critical applications with integral 5 micron filtering.
		HYD-11	Design flexible hose with molded-in color bands to clearly indicate when the maximum wear/abrasion has been reached.
		LG-01	Bearings, excluding wheel bearings, should not require lubrication during the expected life of the air vehicle airframe.
		LG-04	Do not use Beryllium and Beryllium base alloys in any location subject to wear or corrosive atmospheres or in installations where machining may be required.
		LG-05	All bolts or similar threaded means used as adjustable stops should be positively retained in the adjusted reference without reliance on jam nuts, cotter pins, or safety wire.

Guidelines by Category (Cont'd)

Category No.	Category Title	Guideline No.	Guideline
3.04.02	Flight Control Systems and Air Cushion Systems	MC-01	All clamps should contain torque-set or torque-limiting connections to prevent clamp or component failure due to over-torque. Clamp installation call outs should not depend on special tools to establish the required torque values.
		MC-02	Avoid the use of cotter pins, safety wire, safety clips, and similar devices to prevent maintenance-induced events leading to ground vehicle accidents or loss of air vehicles.
		MC-03	All tubing connections and interfaces should use rosan/dynatube (or equivalent) to (1) enable connect or disconnect with one hand, one tool, (2) eliminate the need to safety the connection, (3) provide a superior seal, and (4) negate need to reposition line(s) during component replacement.
		MC-04	No trombone type, flared tube type, or piloted line type interfaces should be used to avoid the need for removal or repositioning during equipment removal.
		MC-05	Avoid potential foreign object traps during manufacturing or operational maintenance by eliminating vertical penetrations of plumbing/fittings into tanks, compartments, or cells.
		MC-06	Locate, position, orient all plumbing and duct electrical connectors to prevent the need for sequential installation or removal.
		MC-09	All plumbing connections and fittings used for fuel systems should contain integral bonding features to eliminate the need for bonding clamps or jumper cables.
		MC-10	In rare instances where a plumbing run contains complex form or geometry that would require removal of other plumbing or equipment for access, in-line connectors should be incorporated to maintain the integrity of other plumbing or equipment.
		MC-11	No subsystem plumbing, equipment, or wiring should use a tank, cell, or compartment containing liquids as a means for routing or penetration simplicity during manufacture.
		MC-12	All plumbing and connectors containing liquids should be meniscus-free.
		MC-13	In instances where plumbing or connector interfaces cannot or are not keyed for a specific orientation, all identification, markings, cautions, and directions should be placed 360 degrees around the tube or duct.
		MC-14	Where multiple connectors are located in close proximity, ensure (1) a minimum hand tool arc of 120 degrees can be maintained, and (2) stagger fittings to ensure firm coupling interface/hand tool interface can be accomplished without inducing damage to adjacent lines.
		MP-01	Avoid the use epoxies to mount parts on repairable modules because they make repair extremely difficult.
		MP-02	Use a unique identification (ID) resistor incorporated in each system module to verify that the proper module is mounted on ATE.
		MP-03	Design modules so that lengthy warm-up times, special coding and air purity levels, and similar constraints are not necessary.
		SIMP-03	Speed brake or speed brake cavity should contain integral mechanical locking mechanism for personnel safety.
		W-01	Hat section type structural stiffeners with sufficient cross sectional area should be considered as a routing tunnel for wiring and coax.
3.04.03	Thrusters	A-09	Any heat or temperature sensitive structure within a compartment should contain heat-sensitive tape or appropriate heat sensor for easy indication of over-temperature excursions.
		A-13	Two-sided or two-surfaced access should not be required for access to equipment interfaces and hardpoints. The term two-sided infers top/bottom, left/right, front/back, or combinations thereof.
		BIT-01	During design of the BIT, use worst-case stress analysis to ensure that any circuit failures induced by temperature extremes, tolerance build-up, power supply variations, and combinations thereof are identified.
		BIT-02	Ensure that BIT system thresholds are consistent with those across the system, subsystem, item, module, and piece-part levels to prevent excessive numbers of Cannot Duplicate (CND) and Retest OK (RTOK) events from occurring.
		BIT-03	The degree of BIT required or proposed should be based on the respective failure rates and the appropriate FMECA at all equipment indenture levels.

Guidelines by Category (Cont'd)

Category No.	Category Title	Guideline No.	Guideline
3.04.03	Thrusters	BIT-04	Limit the amount of data that is recorded to a manageable size by: <ul style="list-style-type: none"> - Limiting the number of signals that are monitored - Limiting the maximum sampling rate - Reducing the time span over which data is accumulated - Restricting the type of data accumulated Incorporate testability design features as an integral part of equipment preliminary design process. Mission critical functions should be monitored by BIT. Use concurrent BIT to monitor system critical functions. All clamps should contain torque-set or torque-limiting connections to prevent clamp or component failure due to over-torque. Clamp installation call outs should not depend on special tools to establish the required torque values. Avoid the use of cotter pins, safety wire, safety clips, and similar devices to prevent maintenance-induced events leading to ground vehicle accidents or loss of air vehicles. All tubing connections and interfaces should use rosan/dynatube (or equivalent) to (1) enable connect or disconnect with one hand, one tool, (2) eliminate the need to safety the connection, (3) provide a superior seal, and (4) negate need to reposition line(s) during component replacement. No trombone type, flared tube type, or piloted line type interfaces should be used to avoid the need for removal or repositioning during equipment removal. Locate, position, orient all plumbing and duct electrical connectors to prevent the need for sequential installation or removal. All plumbing connections and fittings used for fuel systems should contain integral bonding features to eliminate the need for bonding clamps or jumper cables. In rare instances where a plumbing run contains complex form or geometry that would require removal of other plumbing or equipment for access, in-line connectors should be incorporated to maintain the integrity of other plumbing or equipment. No subsystem plumbing, equipment, or wiring should use a tank, cell, or compartment containing liquids as a means for routing or penetration simplicity during manufacture. All plumbing and connectors containing liquids should be meniscus-free. In instances where plumbing or connector interfaces cannot or are not keyed for a specific orientation, all identification, markings, cautions, and directions should be placed 360 degrees around the tube or duct. Where multiple connectors are located in close proximity, ensure (1) a minimum hand tool arc of 120 degrees can be maintained, and (2) stagger fittings to ensure firm coupling interface/hand tool interface can be accomplished without inducing damage to adjacent lines. Do not use cartridge actuated devices (CADs) for store or weapon ejection or for pylon jettison due to inherent ground safety hazards, stray energy hazards, and scheduled cleaning requirements. In rare instances where use of CADs may be required, a positive indication to denote "cartridge installed" should be provided. Stored energy devices (e.g., accumulators, nitrogen bottles, gas generators, etc.), that could cause injury, harm, or damage if inadvertently actuated, should contain integral safing provisions. Electrical and optical safe/arm system design should eliminate the need for mechanical type system interrupt devices. Two-sided or two-surfaced access should not be required for access to equipment interfaces and hardpoints. The term two-sided infers top/bottom, left/right, front/back, or combinations thereof. Closure and sealing of cavities, compartments, and wells for retractable antennas should be mechanized to function as part of the extend and retract cycle. Employ control by wire or control by light technology to eliminate complex control mechanisms and associated maintenance and support. Weapon and store ejectors containing adjustable pitch control devices should ensure devices are easily accessible and adjustments are Murphy-free.
3.05	Mechanisms	AA&S-02	
		ACS-09	
		ARM-09	
		BIT-05	
		BIT-06	
		BIT-09	
		MC-01	
		MC-02	
		MC-03	
		MC-04	
		MC-06	
		MC-09	
		MC-10	
		MC-11	
		MC-12	
		MC-13	
		MC-14	
		PYRO-16	
		PYRO-17	
		SAFE-03	
		SAFE-04	
		A-13	

Guidelines by Category (Cont'd)

Category No.	Category Title	Guideline No.	Guideline
3.05	Mechanisms	BIT-05	Incorporate testability design features as an integral part of equipment preliminary design process.
		BIT-06	Mission critical functions should be monitored by BIT.
		BIT-09	Use concurrent BIT to monitor system critical functions.
		ENG(G)-01	Provide access to all engine mounts for ground vehicles so that hoisting or crawling under the vehicle is not required.
		ENG(G)-02	Use torque-limiting bolts or torque washers as engine mount attaching hardware to eliminate the need for torque wrenches.
		ENG(G)-06	The distance between the engine and firewall should ensure the access envelopes to lines, fittings, wiring, and adjustments will accommodate the 75 percentile male hand.
		ENG(G)-10	Design attaching hardware for all mechanical engine-to-vehicle interfaces to be captive and with integral safeties.
		ENG(G)-20	Design all firewall fittings, connectors, and penetrations to be fully viewable and directly accessible to the maintainers.
		ENG-31	No rigging or calibration should be required subsequent to replacement of any engine-mounted component.
		ENG-32	Design the engine fuel controls and electronic controllers so that no manual fuel grade adjustments are required.
		ENG-38	The characteristics of engine-to-vehicle interfaces coupled with the capabilities of electronic engine controls, should negate the necessity for making any type of engine rigging including maximum power, idle, and idle cut-off.
		ENG-39	Engine-to-vehicle plumbing quick disconnects should contain positive visual indication that the interface is fully seated and locked.
		FUEL-04	Where the fuel wetted area inside a fuel cell or tank is void of blade, knife, and hat stiffeners for use as hardpoint attachment, standoff bonded to the cell surface should be used as attachments for clamps, and brackets to eliminate fastener penetration of the fuel cavity.
		HOOK-01	Locate, orient, and mechanize Nose Gear Tow/Nose Gear Holdback (NGT/NGH) mechanisms so they do not interfere with the hookup and attachment of standard towbars.
		HOOK-02	Design NGT/NGH mechanisms with integral provisions to visually indicate correct hookup/attachment. The indication must be visible during all day and night carrier operations.
		HOOK-03	NGT/NGH mechanisms should not require scheduled visual or NDI type inspections.
		HOOK-04	Design tail hook points to be interchangeable and easily replaceable.
		HOOK-05	Design tail hook points so they can not be incorrectly installed.
		IN(V)-01	Design inlet door actuators and door actuation mechanisms so they not protrude into the air inlet flow field to eliminate FOD potential.
		IN(V)-07	Ensure that no ground safety pins or streamers are used forward of the inlet or within a 3-foot radius aft of the inlet.
		LG-01	Bearings, excluding wheel bearings, should not require lubrication during the expected life of the air vehicle airframe.
		LG-04	Do not use Beryllium and Beryllium base alloys in any location subject to wear or corrosive atmospheres or in installations where machining may be required.
		LG-05	All bolts or similar threaded means used as adjustable stops should be positively retained in the adjusted reference without reliance on jam nuts, cotter pins, or safety wire.
		LG-16	No portion of the landing gear rigging process should require support equipment type templates, gauges, or tools. Indexes, reference points, etc., should be an integral part of the landing gear/airframe design.
		LG-17	Hydraulic, pneumatic, or electrical actuators associated with landing gear systems should not require adjustment or rigging once installed in the air vehicle. Spare units should be rigged at the time of manufacture or overhaul.
		LG-18	Landing gear ground safety down locks should be an integral part of the overall design. Use or reliance on loose pins (support equipment) should be avoided.
		LG-19	When deemed necessary for the respective design, pilots, flight crews, or operators should have an indication of the downlock status in the cockpit or crew station to avoid the necessity of a flight abort.
		LG-20	Special locks and pins used solely for landing gear ground maintenance safety should be used only in those cases substantiated by cost effectiveness analysis.
		LG-25	Mechanical shrink struts, when used, should not permit gear to jam in wheel well if failure of shrink mechanism occurs.
		LG-26	Gravitational emergency extension of landing gear should be given preference over all other concepts.

Guidelines by Category (Cont'd)

Category No.	Category Title	Guideline No.	Guideline
3.05	Mechanisms		
		LG-27	Downlocks should be over-center mechanical type and should not depend on hydraulic pressure to maintain the lock.
		LG-28	Landing gear control handle should have only "up" or "down" detents with no neutral or intermediate positions.
		LG-29	Basic gear design combined with manufacturing tolerances should ensure that no uplock or downlock rigging is required.
		LG-31	Landing gear doors designed to close after gear is extended should be capable of being manually opened on the ground without reliance on electrical or hydraulic power.
		LG-44	Landing gear door mechanisms and interfaces should ensure that multiple cycles or occasional exceedence of maximum gear-down speed do not result in loss of doors
		MC-01	All clamps should contain torque-set or torque-limiting connections to prevent clamp or component failure due to over-torque. Clamp installation call outs should not depend on special tools to establish the required torque values.
		MC-02	Avoid the use of cotter pins, safety wire, safety clips, and similar devices to prevent maintenance-induced events leading to ground vehicle accidents or loss of air vehicles.
		P-06	Access door and panel devices used to support door in opened position should meet the following criteria: - for airborne vehicles, design for 60 knot gust loads (or equivalent jet blast loads) - for ground vehicles, design for 50 mph gust loads
		P-09	Acceptable door and panel hold-open devices include over-center sheet metal spring, over-center spring link, spring cartridge, support strut, and pinned goose neck hinge.
		PERS-01	Group man-machine interfaces manifold-style to enable connect/disconnect in a single action.
		PERS-02	Include an integral, highly visible indicator in a man-machine interface connector to denote connector is seated and locked.
		PERS-03	Design interface connectors so that a distinct action is required by an individual to effect a disconnect. (Excludes airframe-to-ejection seat personnel interfaces.)
		PERS-04	Interfaces should contain an emergency release mechanism that can be activated by rescue personnel with a 95 percentile gloved hand.
		PERS-05	Design emergency interface release mechanisms to be clearly visible under all types of lighting situations.
		PYRO-02	Provide the "safe/arm" status as an external cue discernible from a distance of 10-20 feet.
		PYRO-06	"Safe/arm" mechanism design should be free from FOD potential.
		PYRO-07	Manual "safe/arm" mechanisms should be well-clear of engine exhausts, fuel/toxic vents, fluid drains, control surface deflection envelopes, and rescue path envelopes.
		PYRO-08	Manual "safe/arm" mechanisms should be well-clear of engine exhausts, fuel/toxic vents, fluid drains, control surface deflection envelopes, and rescue path envelopes.
		PYRO-09	Provide positive, Murphy-proof locking detents for both the "safe" and "arm" positions of mechanical mechanisms.
		PYRO-11	Design electrical/electronic "safe/arm" systems to eliminate the need for mechanical type system interrupt devices.
		PYRO-18	Mechanical "safe/arm" mechanism design should enable activation by a 95 percentile male wearing arctic mittens.
		PYRO-35	Suspension system should permit any single weapon or store to be loaded by a two man crew.
		SAFE-07	Landing and alighting gear design should ensure downlocks are integral to the mechanisms and provide a clear indication of position status. This guideline also applies to tail hooks.
		SAFE-08	A single lever safety should, when positioned, safe the entire escape/ejection system. Use of the single lever to "arm" should require two hands.
		SAFE-09	Safing the canopy jettison system should be accomplished through the same lever device used to safe the ejection seat.
		SAFE-11	All individual safety pins used for ground maintenance should be clearly visible and coupled together to ensure no single pin will be overlooked during arming.
		SAFE-12	Internal weapon bay doors should contain integral safety locking features for use during maintenance and weapon loading and downloading.
		SAFE-13	It should not be possible to unsafe a weapon bay door integral lock when a door closed signal is present.
		SEAT-04	Design ejection seats so they can be replaced with canopy or escape hatch installed.
		SIMP-03	Speed brake or speed brake cavity should contain integral mechanical locking mechanism for personnel safety.

Guidelines by Category (Cont'd)

Category No.	Category Title	Guideline No.	Guideline
3.05	Mechanisms	WT&B-02 WT&B-13	Brake-wear indicating pins should be highly visible during day and night operations. Emergency brake handles should not be similar in shape or color as other handles nor should they be located in close proximity to such other handles.
3.05.01	Bellcranks, Pivots, Mechanical Advantage Devices, Shift Devices, Ratio Changers, Pressure Bulkhead/Firewall Penetrators, Etc.	A-06	Hardpoints (structural attachment and load bearing areas) within a compartment to assist in equipment mounting or support should not be integral with the machined part. Hardpoints should be parasitic to enable quick repair in case of wear or damage in lieu of precise ream/bush repair typical of machined hardpoints.
		A-13	Two-sided or two-surfaced access should not be required for access to equipment interfaces and hardpoints. The term two-sided infers top/bottom, left/right, front/back, or combinations thereof.
		ACS-09	Employ control by wire or control by light technology to eliminate complex control mechanisms and associated maintenance and support.
		BIT-05	Incorporate testability design features as an integral part of equipment preliminary design process.
		BIT-06	Mission critical functions should be monitored by BIT.
		CONT-01	Control rods should use Boyd or impedance type bolts (or equivalent) to eliminate the need for cotter pins or safety wire.
		CONT-02	Do not use metal control cables for vehicles that will operate in salt water or salt air environments.
		CONT-03	Use control rods rather than control cables for non-complex applications and non-complex routing within the vehicle.
		CONT-04	Use control cables rather than control rods for most complex applications.
		CONT-05	Route cables so that 100 percent of a cable will be viewable for inspection.
		CONT-06	Design all pulleys and brackets associated with cable installations so they are accessible by a 75 percentile male hand.
		CREW-04	Avoid wiring, coax, and plumbing penetrations through the floor of crew cabs, operators' compartments, crew stations, cockpits, and passenger compartments.
		ENG(G)-06	The distance between the engine and firewall should ensure the access envelopes to lines, fittings, wiring, and adjustments will accommodate the 75 percentile male hand.
		ENG(G)-10	Design attaching hardware for all mechanical engine-to-vehicle interfaces to be captive and with integral safeties.
		ENG(G)-20	Design all firewall fittings, connectors, and penetrations to be fully viewable and directly accessible to the maintainers.
		ENG-09	On multi-engine air vehicles, the engines should be capable of being installed in any engine cavity without need for reconfiguration.
		ENG-10	On multi-engine air vehicles, the airframe-to-engine interfaces should be in identical positions or orientations for each engine cavity.
		ENG-31	No rigging or calibration should be required subsequent to replacement of any engine-mounted component.
		ENG-38	The characteristics of engine-to-vehicle interfaces coupled with the capabilities of electronic engine controls, should negate the necessity for making any type of engine rigging including maximum power, idle, and idle cut-off.
		ENG-39	Engine-to-vehicle plumbing quick disconnects should contain positive visual indication that the interface is fully seated and locked.
		FUEL-04	Where the fuel wetted area inside a fuel cell or tank is void of blade, knife, and hat stiffeners for use as hardpoint attachment, standoff's bonded to the cell surface should be used as attachments for clamps, and brackets to eliminate fastener penetration of the fuel cavity.
		IN(V)-01	Design inlet door actuators and door actuation mechanisms so they not protrude into the air inlet flow field to eliminate FOD potential.
		LG-01	Bearings, excluding wheel bearings, should not require lubrication during the expected life of the air vehicle airframe.
		LG-04	Do not use Beryllium and Beryllium base alloys in any location subject to wear or corrosive atmospheres or in installations where machining may be required.
		LG-05	All bolts or similar threaded means used as adjustable stops should be positively retained in the adjusted reference without reliance on jam nuts, cotter pins, or safety wire.

Guidelines by Category (Cont'd)

Category No.	Category Title	Guideline No.	Guideline
3.05.01	Bellcranks, Pivots, Mechanical Advantage Devices, Shift Devices, Ratio Changers, Pressure Bulkhead/Firewall Penetrators, Etc.	LG-06	Design struts, attachments, and interfaces so they do not depend on scheduled visual inspections, non-destructive inspection (NDI), or non-destructive test (NDT) to ensure the reliability or integrity of the system in the operational environment.
		LG-07	No portion of the landing gear struts, drag braces, or interfaces should contain pockets or bathtubs that can trap or hold moisture. In rare instances where this is not possible, holes should be drilled as appropriate to prevent moisture/liquid accumulation.
		LG-08	Brackets, levers, links, rods, et al mounted on the struts should either be symmetrical to tolerate reverse installation or should be impossible to reverse.
		LG-16	No portion of the landing gear rigging process should require support equipment type templates, gauges, or tools. Indexes, reference points, etc., should be an integral part of the landing gear/airframe design.
		LG-44	Landing gear door mechanisms and interfaces should ensure that multiple cycles or occasional exceedence of maximum gear-down speed do not result in loss of doors
		MC-02	Avoid the use of cotter pins, safety wire, safety clips, and similar devices to prevent maintenance-induced events leading to ground vehicle accidents or loss of air vehicles.
		TCR-07	Design mechanical interfaces to transmissions, clutches, and rotors so that the respective unit can be replaced without the need for rigging.
3.06	Avionics and Electronics	A-10	Provide a sufficient number of compartment fluid drains to ensure fluid drainage for varying aircraft static attitudes and varying terrain slopes for ground vehicles.
		A-11	Locate compartment electrical penetrations close to the access opening for ease of sight, probing, repair, and to eliminate fluid soaking, wicking, or contamination.
		A-12	Locate compartment electrical penetrations far enough from the access opening to prevent damage resulting from improper (over-length) panel fasteners.
		A-13	Two-sided or two-surfaced access should not be required for access to equipment interfaces and hardpoints. The term two-sided infers top/bottom, left/right, front/back, or combinations thereof.
		A-15	Locate tie-down attachment points such that tie-down chains, straps, or cables do not prevent or restrict normal servicing, weapon loading, or safe/arm functions.
		A-18	Use transparent windows, quick-opening covers, or openings without any cover to permit quick visual inspections where needed.
		AA&S-01	Flush mounted antennas, sensors, and air data devices should have a good color contrast to surrounding structure when located in walkway areas.
		AA&S-02	Closure and sealing of cavities, compartments, and wells for retractable antennas should be mechanized to function as part of the extend and retract cycle.
		AA&S-03	Closure and sealing of cavities, compartments, and wells for retractable antennas should be maintained when antennas are not installed without need for ancillary measures or equipment.
		AA&S-04	LO antennas should be designed to be tolerant of accumulations of grime or dirt without degrading performance or biasing the BIT/fault isolate performance.
		AA&S-05	Multi-function antennas, arrays, and sensors located in leading edges should be modularized to reduce vehicle downtime through simplified replacement of a faulty module.
		AA&S-06	Moveable flaps or slats containing integral antennas, arrays, or sensors should be interchangeable to provide the option for on-vehicle or off-vehicle repair.
		BIT-01	During design of the BIT, use worst-case stress analysis to ensure that any circuit failures induced by temperature extremes, tolerance build-up, power supply variations, and combinations thereof are identified.
		BIT-02	Ensure that BIT system thresholds are consistent with those across the system, subsystem, item, module, and piece-part levels to prevent excessive numbers of Cannot Duplicate (CND) and Retest OK (RTOK) events from occurring.
		BIT-03	The degree of BIT required or proposed should be based on the respective failure rates and the appropriate FMECA at all equipment indenture levels.

Guidelines by Category (Cont'd)

Category No.	Category Title	Guideline No.	Guideline
3.06	Avionics and Electronics	BIT-04	<p>Limit the amount of data that is recorded to a manageable size by:</p> <ul style="list-style-type: none"> - Limiting the number of signals that are monitored - Limiting the maximum sampling rate - Reducing the time span over which data is accumulated - Restricting the type of data accumulated <p>Incorporate testability design features as an integral part of equipment preliminary design process.</p> <p>Mission critical functions should be monitored by BIT.</p> <p>Set BIT tolerances to maximize fault detection and minimize false alarm rate in the expected operating environment.</p> <p>Design BIT fault detectors to accommodate the needs of operator maintenance personnel.</p> <p>Use concurrent BIT to monitor system critical functions.</p> <p>Design the BIT and BITE so that no fault or failure within the BIT or BITE will degrade, disrupt, or fail the system being monitored.</p> <p>In the area of software design and test responsibility, the responsibility for the design and development of verification testing of an end item (e.g., digital filter) should reside with the same engineer(s).</p> <p>Define stimuli and response data for each diagnostic test at the system/subsystem level. The same data should be planned for use both in factory testing as well as in field maintenance of the equipment. These data minimize the amount of unique software to be written.</p> <p>Provide for manual control to test sequences, so that the test can be selected individually, and appropriate test combinations can be executed at the operator's discretion.</p> <p>Provide access to all BIT control and status signals at module connector pins. This will enable ATE to directly connect to BIT circuitry.</p> <p>Incorporate complete BIT functions and BITE on module. If only a portion of the BIT routine or BITE circuitry exists on the module, then ATE cannot utilize the BIT routine without providing the missing BIT functions.</p> <p>The failure detection function should provide the equipment operator with a go/no-go indication of equipment readiness.</p> <p>The BIT should be designed so that auxiliary test devices or external equipment are not needed for daily and other regular checks.</p> <p>Design BIT so it is initiated automatically upon equipment power-up.</p> <p>Test points should be functionally grouped together and clearly labeled for convenience and ease of maintenance.</p> <p>Equipment should not require manual probing to fault isolate.</p> <p>Locate routinely used test points so they are accessible without removing or disassembling other equipment</p> <p>Periodic and initiated BIT should detect at least 98% of all failures and isolate a minimum 99% of those failures detected to a single LRU or WRA.</p> <p>Design BIT to have the same level of EMI protection as the system or equipment being monitored.</p> <p>Design EMI protection to eliminate finger type EMI contact devices.</p> <p>Ground vehicles with storage bays or compartments accessible from outside the vehicle should:</p> <ul style="list-style-type: none"> - Have the door sill located no lower than knee height to accommodate a wide range of percentiles while standing. - Ensure door handles are flush with outer surface to protect personnel. - Contain goose neck hinges to protect the hinge from the elements. - Ensure door can be opened with transport tie downs installed. - Ensure door opening envelope does not intrude into the opening envelope of an adjacent door. - Contain simple sheet metal hold-open spring or mechanism. - Ensure floor of bay or compartment is flush with sill to simplify cleanout and drainage. - Ensure door unlocking and opening mechanism can be actuated by a 95 percentile male hand while wearing arctic gloves. - Contain 15 percent added volume for density growth.
		BIT-05	
		BIT-06	
		BIT-07	
		BIT-08	
		BIT-09	
		BIT-10	
		BIT-11	
		BIT-12	
		BIT-13	
		BIT-14	
		BIT-15	
		BIT-21	
		BIT-22	
		BIT-23	
		BIT-24	
		BIT-25	
		BIT-26	
		BIT-27	
		BIT-28	
		BIT/BITE-02	
		CARGO-01	

Guidelines by Category (Cont'd)

Category No.	Category Title	Guideline No.	Guideline
3.06	Avionics and Electronics		
		CARGO-02	Ground vehicles with small exterior storage bays or compartments containing emergency equipment or supplies should: <ul style="list-style-type: none"> - Be located at chest height of the 50 percentile male. - Contain unlatching mechanisms activated by pushing inward on the door. - Meet all other generic bay and compartment requirements.
		CC-01	Use fiber-optic technologies in preference to conventional interconnect concepts to reduce the number of interconnects/interfaces, reduce manufacturing and ownership costs, and significantly improve R&M.
		CC-02	Standardize connector and wire types to improve testability and logistic support. Keep the number of "different" standard connectors to a minimum. Use the same connector type keyed differently where possible.
		CC-03	Provide clearance around connectors for engagement/disengagement of cables and proper connector orientation under anticipated environmental conditions (e.g., bare hand of 50 percentile male in an enclosed or protected environment and a gloved hand of a 50 percentile male in an open or unprotected environment).
		CC-04	Use quick release cables and locate cables to make removal and replacement easy and to avoid having to remove one cable to gain access to another. Provide adequate space for cables, including sleeving and tie-downs, and adequate service loops for ease of assembly/disassembly
		CC-05	Orient and space connectors to allow a sufficient grip on the connector for cable or wire extraction without fear of using the wiring or cable for additional leverage.
		CC-06	Label, and where possible color code, each wire in a harness or cable to facilitate tracking from origin to termination. Each wire, cable, and coax-to-connector interface should be provided with a source of identification to aid in trouble shooting, repair, or modification. Marking the cable designator on the cable along with bar codes is also recommended.
		CC-07	Do not manufacture or dress connectors containing more than 25 wires or cables as a single integrated harness. Group the wires or cables into runs of no more than 25 wires or cables each. In addition to making trouble shooting and repair easier, this approach help avoid large bend radii, thereby simplifying routing, packaging, and stowage.
		CC-08	Standardize connector pin assignments for power, ground, and other frequently used signals.
		CC-09	Locate LRU/subsystem critical nodes (and or test points) so they are accessible from a connector to prevent the need for internal LRU probing or access.
		CC-10	Avoid hidden cables. Visually inspecting and tracing all assembly cables rather than having hidden cables (such as behind other cables or even LRUs) allows for a quick system and cable integrity check which aids in overall system integrity and debug. This also implies quick access for manipulative actions.
		CC-11	Orient spare wires and cable pigtails along the outer diameter or periphery of connectors to make access easier.
		CC-12	Build up and assemble straight and angle connector shells or back shells in a manner that ensures that wire or cable strain or wear is not possible.
		CO-01	Design automated systems and programs with provisions to enable "stop test" and "resume" without the need to cycle back or repeat the entire test.
		CO-02	In the event of program loss or hang-up, automated systems and programs should have provisions for reverting to manual test and operation.
		CO-03	Use a test connector to provide test and maintenance bus access to all system and subsystem faults.
		CO-04	Design systems and subsystems so that ATE can be used to access, read, and control internal components in concert with the test or checkout program.
		CO-05	Avoid the need for costly adapters for signal communications between system, subsystems, line replaceable units (LRUs) or Weapon Replaceable Assemblies (WRAs), and ATE.
		CREW-04	Avoid wiring, coax, and plumbing penetrations through the floor of crew cabs, operators' compartments, crew stations, cockpits, and passenger compartments.
		CREW-06	Film magazines, tapes, and removable modules should permit considerable handling without reliance on special support equipment protection.
		CREW-07	Electronic and photosensitive storage media should withstand the adverse environment created by ground, flightline, or shipboard electromagnetic fields and light sources.
		CREW-08	Data storage media containers and modules should be capable of chemical and biological decontamination processes.

Guidelines by Category (Cont'd)

Category No.	Category Title	Guideline No.	Guideline
3.06	Avionics and Electronics		
		CREW-09	Crew and operator station cassettes or magazines should be capable of being removed and installed with one hand while the operator or air crew is seated and strapped in.
		CREW-10	Design cameras, recorders, and sensors to be fully interchangeable and quickly replaceable.
		CREW-11	Design cameras, lenses, reconnaissance pods, aiming devices, and related equipment so they can be reconfigured by one individual.
		CREW-12	Requirements for boresighting should not be part of the design or integration.
		CREW-13	Provide storage provisions in each vehicle type (ground and airborne) to store extra tapes, modules, cassettes, as appropriate to the intended vehicle use/mission.
		D&V-01	The geometric aspects of structural design and interfaces should not result in any natural bathtubs.
		D&V-02	Closed structural sections subject to condensation or fluid migration should contain drainage provisions.
		D&V-03	Crew cabs, operators' compartments, crew stations, cockpits, and passenger compartments should be subject to the same corrosion prevention measures as the exteriors of the vehicles. Low points, pockets, and related fluid collection points within should be provided with low point drains.
		EC-01	A threaded electrical connector should contain integral locking mechanisms and visual indications that the connector is properly seated and locked.
		EC-02	An electrical connector requiring less than one full turn to connect or disconnect should contain integral locking mechanisms and visual indications that the connector is properly seated and locked.
		EC-03	A push-pull electrical connector (excluding rack-and-panel type) should contain integral locking features and visual indication that the connector is properly seated and locked.
		EC-04	All electrical connectors should be keyed or asymmetrically shaped to ensure proper alignment.
		EC-05	All electrical connectors should contain scoop-proof shells to ensure pin damage will not occur prior to engaging key way.
		EC-06	All electrical connectors should be corrosion resistant to reduce or eliminate the need for scheduled inspections or corrosion prevention measures.
		EC-07	Avoid using electrical connectors requiring any type or form of soldering.
		EC-08	Locate and position electrical connectors such that all pin identification for either half can be easily seen.
		EC-09	Electrical connectors selected for critical applications on ground vehicles should be both accessible and capable of being connected disconnected by a fifty percentile gloved male hand.
		EC-10	Separation between grouped electrical connectors should be sufficient to ensure make or break of any connector by a fifty percentile gloved male hand. Where this is not possible, an alternate method should be used such as the use of stand-offs, long-shelled connectors alternated with standard connectors, 180-degree connectors alternated with 90-degree connectors, or innovative equivalents.
		EC-16	Select connectors so that contacts on the "live" or "hot" side of the connection are socket type rather than pin type to minimize personnel hazard and to prevent accidental shorting of live circuits.
		EC-17	Whenever possible, use self-locking connector plugs of a type not requiring safety wire.
		EC-18	All electric connectors should be environment resistant.
		EC-19	Connectors containing fiber optic contacts should, whenever possible, be mounted on a vertical surface to prevent particle and fluid contamination.
		EC-20	Use quick disconnect connectors where allowed and identify all pins on each connector.
		EC-21	Locate connectors far enough apart so that they meet specified requirements.
		EC-22	All connectors should be keyed differently with aligning pins that extend beyond the electrical pins. Connector pins and sockets should engage after key position is entered.
		EC-23	Design connectors so that plugs are cold and receptacles are hot.
		EC-24	Use electrical connectors that incorporate alignment key-ways to reduce incidents of damage due to improper engagement.

Guidelines by Category (Cont'd)

Category No.	Category Title	Guideline No.	Guideline
3.06	Avionics and Electronics	EC-25	Use positive locking, quick disconnect electrical connectors to save man-hours, prevent foreign object damage (FOD) and decrease the chance of personal injury.
		EC-26	Avoid using identical electrical connectors in adjacent areas.
		EDECOM-02	Provide integral sensors (viewable from the exterior) for equipment subject to internal forced-air cooling from outside or external air to indicate the presence of contaminants.
		EG-01	Design feedback loops so that the loop can be broken during test to ensure that faults do not propagate to the point where they cannot be isolated.
		EG-02	Avoid using external feedback loops requiring complex circuitry to simulate feedback I/Os.
		EG-03	In rare instances when complex external feedback loops cannot be avoided, incorporate simple interruptible control points.
		EG-04	Avoid long sequences of vectors to initialize or alter device outputs to minimize potential testability problems.
		EG-05	Avoid the need to have test equipment generate complex, phased or time related signals.
		EG-06	Test points should be located on all circuit nodes that are useful in determining the module's health.
		EG-07	Test points should be designed so that functional circuitry cannot be damaged or degraded due to the routing or accidental shorting of a signal at a test point. Some type of test point isolation technique should be used (buffers, isolator, etc.).
		EG-08	Test points should be easily accessed and clearly marked.
		EG-10	Design redundant circuits to be independently testable to ensure errors are not masked.
		EG-11	To improve the probability of fault detection, avoid shorting signals together to achieve a specific test function or condition.
		EG-12	Incorporate concept for partitioning module functions to simplify test equipment or eliminate the need for ancillary test equipment.
		EG-13	Design oscillators or clocks that are resident on the module to be replaceable by a signal from a connector to avoid the need to synchronize ATE to on-board signals.
		ENG(G)-20	Design all firewall fittings, connectors, and penetrations to be fully viewable and directly accessible to the maintainers.
		ENG-01	All facets of engine design should take advantage of Electrostatic Engine Monitoring Systems (EEMS) and Inductive Debris Monitoring (IDM) toward achievement of on-condition maintenance and engine health monitoring.
		ENG-03	Digital electronic controls, fully automatic digital electronic controls, and similar concepts should contain the highest degree of BIT and diagnostics commensurate with affordability, operation and maintenance, and life cycle costs as appropriate.
		ENG-11	Control-by-wire or control-by-light throttling concepts should take precedence over mechanical controls.
		ENG-20	Do not locate equipment or components in the engine cavity except for those components associated with the engine or engine installation.
		ENG-21	Do not locate equipment or components in the engine bay cavity in a manner that would require removal or repositioning for engine removal.
		ENG-26	Locate and position engine overheat and fire warning sensors so that damage cannot occur during engine maintenance or replacement.
		ENG-35	No time-change components or scheduled actions should be planned solely to protect component integrity or reliability.
		ENG-38	The characteristics of engine-to-vehicle interfaces coupled with the capabilities of electronic engine controls, should negate the necessity for making any type of engine rigging including maximum power, idle, and idle cut-off.
		ENG-40	Design of electronic engine controls should be such that no single failure of a sub-component within can result in over speed, over temperature, stagnation, or shut-down.
		FI-01	Design each FI test to be independent of all other tests.
		FI-02	Design FI initiation to be subordinate to the higher priority predecessor tests.
		FI-03	Design each test so that it can be terminated prior to completion and then re-initiated at its start point.

Guidelines by Category (Cont'd)

Category No.	Category Title	Guideline No.	Guideline
3.06	Avionics and Electronics		
		FI-04	Design the unit tests so that they can accommodate the following subsystem response modes: - Incorrect response - No response - Inconsistent response - Unexpected condition
		FI-05	Design all software so that it is structured by test priority. The test software should take advantage of both subroutine constructs for all message outputs and of failure dictionaries which identify the location of the most likely failed replaceable unit.
		FI-06	In an airborne avionics system, consider indicating mission critical faults on a pilots "head-up" display accompanied with an audible alarm, so that the pilot can easily check for critical system or mission threatening problems.
		FI-07	Ensure that system user manuals include instructions for faults not covered by BIT such as, system will not power up or system is being used in an incorrect environment such as, at the wrong altitude, etc.
		FI-08	Interlock the high power sections of systems and subsystems with visual/audible BIT to ensure safe system activation.
		FI-09	Design BIT to first conduct self-test for circuitry integrity before conducting system test.
		FI-10	Use clear text to report failures rather than alpha-numeric codes, lights, indicators, etc.
		FI-11	Locate BIT circuitry on the same level of the subsystem under test to simplify test and repair when it is removed from the main system.
		LG-35	Avoid the use of landing gear doors to mount or house antennas, arrays, or air data sensors.
		LO-01	Use LO compatible gap fillers for manufactured gaps in lieu of tape and butter (surface coating compound).
		LO-02	Avoid scheduled forced inspections or replacement of materials, coatings, or finishes solely to protect either the reliability or the signature.
		LO-03	Equipment and support structure requiring shrouds to reduce radar returns should not cause increases in equipment service/repair time.
		LO-04	Infrequently-accessed structural doors and panels incorporating special coatings or conductive paints should contain provisions for prying the door or panel clear of moldline with standard screwdriver without damage.
		LO-05	Do not locate flush mounted LO screens for auxiliary air inlets and exits in walkway areas unless durability has been proven.
		LO-06	Size flush mounted LO screens for auxiliary air inlets and exits to ensure functionality with up to 25 percent of the openings plugged.
		LO-07	Flush and non-flush LO screens should be interchangeable.
		MC-02	Avoid the use of cotter pins, safety wire, safety clips, and similar devices to prevent maintenance-induced events leading to ground vehicle accidents or loss of air vehicles.
		MC-06	Locate, position, orient all plumbing and duct electrical connectors to prevent the need for sequential installation or removal.
		MC-10	In rare instances where a plumbing run contains complex form or geometry that would require removal of other plumbing or equipment for access, in-line connectors should be incorporated to maintain the integrity of other plumbing or equipment.
		MC-12	All plumbing and connectors containing liquids should be meniscus-free.
		MC-14	Where multiple connectors are located in close proximity, ensure (1) a minimum hand tool arc of 120 degrees can be maintained, and (2) stagger fittings to ensure firm coupling interface/hand tool interface can be accomplished without inducing damage to adjacent lines.
		MG-01	Mount LRUs/sub-systems on drawer slides or extender racks to provide easier accessibility during integration, testing, debug, and repair of Units Under Test (UUTs).
		MG-02	Use a modular system design so that each subassembly is designed as a functionally complete entity. Then when a subassembly was removed for testing, ATE will not need custom circuitry to simulate missing functions.
		MG-03	Clearly mark all subsystems/LRUs to make system integration, test, debug, and repair easier.
		MP-01	Avoid the use epoxies to mount parts on repairable modules because they make repair extremely difficult.

MIL-HDBK-470A

APPENDIX C

Guidelines by Category (Cont'd)

Category No.	Category Title	Guideline No.	Guideline
3.06	Avionics and Electronics		
		MP-02	Use a unique identification (ID) resistor incorporated in each system module to verify that the proper module is mounted on ATE.
		MP-03	Design modules so that lengthy warm-up times, special coding and air purity levels, and similar constraints are not necessary.
		OXY-01	System should contain automatic BIT for warning indicators to eliminate dedicated test switches and/or test requirements.
		P-06	Access door and panel devices used to support door in opened position should meet the following criteria: - for airborne vehicles, design for 60 knot gust loads (or equivalent jet blast loads) - for ground vehicles, design for 50 mph gust loads
		P-07	Hinged access doors and panels capable of remaining in the opened position should not have sharp edges or corners.
		P-08	Removable access door and panel fasteners should be of identical grip length and diameter.
		P-09	Acceptable door and panel hold-open devices include over-center sheet metal spring, over-center spring link, spring cartridge, support strut, and pinned goose neck hinge.
		P-10	Access doors and panels requiring non-captive fasteners should not be located forward of air inlet ducts or high-energy rotating components (e.g., prop fans, engine cooling fans, etc.).
		P-11	Access doors and panels should be interchangeable as justified by operation and support costs or life cycle costs.
		PERS-09	Design portable emergency locator beacons, radio receiver/transmitters, global positioning systems, and similar battery operated devices with integral provisions for determining battery health or status and remaining battery life.
		PYRO-26	Do not locate ammunition loader interfaces close to inlets, exhausts, fuel dumps and drains, antennas, sensors, lights, or hazardous protrusions.
		SABCH-06	Structural design should avoid the potential of dissimilar material or fastener corrosion.
		SABCH-07	No structural fasteners should be used that require special tools for installation.
		SABCH-08	Taper pins should be threaded and retained with self-locking hardware.
		SABCH-09	Pins and collars (lockbolts) should only be used in applications which do not normally require removal.
		SABCH-10	Do not use lockbolts in composites.
		TP-01	Locate Input/Output (I/O) test points and associated readouts in close proximity to each other so that one person can perform testing.
		TP-02	Protect test points against the environment and from induced contamination.
		TP-03	Protect test points from outside signal generation.
		W-01	Hat section type structural stiffeners with sufficient cross sectional area should be considered as a routing tunnel for wiring and coax.
		WBAY-01	Equipment bays and compartments should not require installation of special cavity fillers when equipment is not installed.
		WIND-01	Optical window materials should be scratch resistant, easy to clean, and dissipate electrostatic charges.
		WIND-02	Optic windows should be located for ease of inspection, cleaning, and induced damage potential from personnel or support equipment.
		WIND-03	Window locations should minimize the effects of contamination by salt spray, bugs, oils, fuels, and icing.
		WIND-04	Window, canopy, and windshield material should be designed to withstand the effects of sandstorms in the ground environment and the effects of rain and hail during thunderstorm penetration in the airborne environment.
		WIND-05	Design interior surfaces to be reachable for cleaning without reliance on hinging, equipment removal, or use of support equipment.
		WIND-11	For dome-shaped optic window concepts, the dome should be easily removable for cleaning without affecting LO integrity.
		WIND-12	Design EO windows and optics to be interchangeable among the same air vehicle types or same ground vehicle types.
		WIND-13	The combination of material layers and coatings for optics and windows should be such that static charge buildup for worst case conditions should not exceed 10,000 volts.
		WIND-14	Exterior lights should permit simple and rapid bulb replacement without disturbing LO treatments.

Guidelines by Category (Cont'd)

Category No.	Category Title	Guideline No.	Guideline
3.06	Avionics and Electronics	WIND-15	Design light covers and lenses to be sufficiently durable so that protective covers are not needed during maintenance.
		WIND-16	Lens shape should enhance LO capability to reduce need, care, and expense for special coatings.
3.06.01	Antennas, Apertures, and Sensors	A-11	Locate compartment electrical penetrations close to the access opening for ease of sight, probing, repair, and to eliminate fluid soaking, wicking, or contamination.
		A-12	Locate compartment electrical penetrations far enough from the access opening to prevent damage resulting from improper (over-length) panel fasteners.
		AA&S-01	Flush mounted antennas, sensors, and air data devices should have a good color contrast to surrounding structure when located in walkway areas.
		AA&S-02	Closure and sealing of cavities, compartments, and wells for retractable antennas should be mechanized to function as part of the extend and retract cycle.
		AA&S-03	Closure and sealing of cavities, compartments, and wells for retractable antennas should be maintained when antennas are not installed without need for ancillary measures or equipment.
		AA&S-04	LO antennas should be designed to be tolerant of accumulations of grime or dirt without degrading performance or biasing the BIT/fault isolate performance.
		AA&S-05	Multi-function antennas, arrays, and sensors located in leading edges should be modularized to reduce vehicle downtime through simplified replacement of a faulty module.
		AA&S-06	Moveable flaps or slats containing integral antennas, arrays, or sensors should be interchangeable to provide the option for on-vehicle or off-vehicle repair.
		BIT-01	During design of the BIT, use worst-case stress analysis to ensure that any circuit failures induced by temperature extremes, tolerance build-up, power supply variations, and combinations thereof are identified.
		BIT-02	Ensure that BIT system thresholds are consistent with those across the system, subsystem, item, module, and piece-part levels to prevent excessive numbers of Cannot Duplicate (CND) and Retest OK (RTOK) events from occurring.
		BIT-03	The degree of BIT required or proposed should be based on the respective failure rates and the appropriate FMECA at all equipment indenter levels.
		BIT-04	Limit the amount of data that is recorded to a manageable size by: <ul style="list-style-type: none"> - Limiting the number of signals that are monitored - Limiting the maximum sampling rate - Reducing the time span over which data is accumulated - Restricting the type of data accumulated
		BIT-05	Incorporate testability design features as an integral part of equipment preliminary design process.
		BIT-06	Mission critical functions should be monitored by BIT.
		BIT-09	Use concurrent BIT to monitor system critical functions.
		BIT-26	Locate routinely used test points so they are accessible without removing or disassembling other equipment
		CC-01	Use fiber-optic technologies in preference to conventional interconnect concepts to reduce the number of interconnects/interfaces, reduce manufacturing and ownership costs, and significantly improve R&M.
		CC-02	Standardize connector and wire types to improve testability and logistic support. Keep the number of "different" standard connectors to a minimum. Use the same connector type keyed differently where possible.
		CC-03	Provide clearance around connectors for engagement/disengagement of cables and proper connector orientation under anticipated environmental conditions (e.g., bare hand of 50 percentile male in an enclosed or protected environment and a gloved hand of a 50 percentile male in an open or unprotected environment).
		CC-04	Use quick release cables and locate cables to make removal and replacement easy and to avoid having to remove one cable to gain access to another. Provide adequate space for cables, including sleeving and tie-downs, and adequate service loops for ease of assembly/disassembly
		CC-05	Orient and space connectors to allow a sufficient grip on the connector for cable or wire extraction without fear of using the wiring or cable for additional leverage.

Guidelines by Category (Cont'd)

Category No.	Category Title	Guideline No.	Guideline
3.06.01	Antennas, Apertures, and Sensors	CC-06	Label, and where possible color code, each wire in a harness or cable to facilitate tracking from origin to termination. Each wire, cable, and coax-to-conductor interface should be provided with a source of identification to aid in trouble shooting, repair, or modification. Marking the cable designator on the cable along with bar codes is also recommended.
		CC-07	Do not manufacture or dress connectors containing more than 25 wires or cables as a single integrated harness. Group the wires or cables into runs of no more than 25 wires or cables each. In addition to making trouble shooting and repair easier, this approach help avoid large bend radii, thereby simplifying routing, packaging, and stowage.
		CC-08	Standardize connector pin assignments for power, ground, and other frequently used signals.
		CC-09	Locate LRU/subsystem critical nodes (and or test points) so they are accessible from a connector to prevent the need for internal LRU probing or access.
		CC-10	Avoid hidden cables. Visually inspecting and tracing all assembly cables rather than having hidden cables (such as behind other cables or even LRUs) allows for a quick system and cable integrity check which aids in overall system integrity and debug. This also implies quick access for manipulative actions.
		CC-11	Orient spare wires and cable pigtailed along the outer diameter or periphery of connectors to make access easier.
		CC-12	Build up and assemble straight and angle connector shells or back shells in a manner that ensures that wire or cable strain or wear is not possible.
		CO-01	Design automated systems and programs with provisions to enable "stop test" and "resume" without the need to cycle back or repeat the entire test.
		CO-02	In the event of program loss or hang-up, automated systems and programs should have provisions for reverting to manual test and operation.
		CO-03	Use a test connector to provide test and maintenance bus access to all system and subsystem faults.
		CO-04	Design systems and subsystems so that ATE can be used to access, read, and control internal components in concert with the test or checkout program.
		CO-05	Avoid the need for costly adapters for signal communications between system, subsystems, line replaceable units (LRUs) or Weapon Replaceable Assemblies (WRAs), and ATE.
		D&V-01	The geometric aspects of structural design and interfaces should not result in any natural bathtubs.
		D&V-02	Closed structural sections subject to condensation or fluid migration should contain drainage provisions.
		D&V-03	Crew cabs, operators' compartments, crew stations, cockpits, and passenger compartments should be subject to the same corrosion prevention measures as the exteriors of the vehicles. Low points, pockets, and related fluid collection points within should be provided with low point drains.
		EC-01	A threaded electrical connector should contain integral locking mechanisms and visual indications that the connector is properly seated and locked.
		EC-02	An electrical connector requiring less than one full turn to connect or disconnect should contain integral locking mechanisms and visual indications that the connector is properly seated and locked.
		EC-03	A push-pull electrical connector (excluding rack-and-panel type) should contain integral locking features and visual indication that the connector is properly seated and locked.
		EC-04	All electrical connectors should be keyed or asymmetrically shaped to ensure proper alignment.
		EC-05	All electrical connectors should contain scoop-proof shells to ensure pin damage will not occur prior to engaging key way.
		EC-06	All electrical connectors should be corrosion resistant to reduce or eliminate the need for scheduled inspections or corrosion prevention measures.
		EC-07	Avoid using electrical connectors requiring any type or form of soldering.
		EC-08	Locate and position electrical connectors such that all pin identification for either half can be easily seen.
		EC-09	Electrical connectors selected for critical applications on ground vehicles should be both accessible and capable of being connected disconnected by a fifty percentile gloved male hand.

Guidelines by Category (Cont'd)

Category No.	Category Title	Guideline No.	Guideline
3.06.01	Antennas, Apertures, and Sensors	EC-10	Separation between grouped electrical connectors should be sufficient to ensure make or break of any connector by a fifty percentile gloved male hand. Where this is not possible, an alternate method should be used such as the use of stand-offs, long-shelled connectors alternated with standard connectors, 180-degree connectors alternated with 90-degree connectors, or innovative equivalents.
		EC-16	Select connectors so that contacts on the "live" or "hot" side of the connection are socket type rather than pin type to minimize personnel hazard and to prevent accidental shorting of live circuits.
		EC-17	Whenever possible, use self-locking connector plugs of a type not requiring safety wire.
		EC-18	All electric connectors should be environment resistant.
		EC-19	Connectors containing fiber optic contacts should, whenever possible, be mounted on a vertical surface to prevent particle and fluid contamination.
		EC-20	Use quick disconnect connectors where allowed and identify all pins on each connector.
		EC-21	Locate connectors far enough apart so that they meet specified requirements.
		EC-22	All connectors should be keyed differently with aligning pins that extend beyond the electrical pins. Connector pins and sockets should engage after key position is entered.
		EC-23	Design connectors so that plugs are cold and receptacles are hot.
		EC-24	Use electrical connectors that incorporate alignment key-ways to reduce incidents of damage due to improper engagement.
		EC-25	Use positive locking, quick disconnect electrical connectors to save man-hours, prevent foreign object damage (FOD) and decrease the chance of personal injury.
		EC-26	Avoid using identical electrical connectors in adjacent areas.
		ENV-01	Materials, treatments, coatings, finishes should be compatible with all anti-ice and de-ice fluids, chemical and biological decontamination fluids, washing and cleaning fluids, and all vehicle subsystem fluids.
		ENV-02	There should be no top coat or treatment deterioration throughout the standard temperature and humidity spectrum.
		ENV-03	For airborne vehicles, the finishes should be durable against rain, hail, and dynamic erosion throughout the flight envelope.
		ENV-04	For airborne and ground vehicles, the finishes should be durable against sand erosion throughout all surface wind speeds experienced in arid or desert geographical locations.
		LG-35	Avoid the use of landing gear doors to mount or house antennas, arrays, or air data sensors.
		LO-01	Use LO compatible gap fillers for manufactured gaps in lieu of tape and butter (surface coating compound).
		LO-02	Avoid scheduled forced inspections or replacement of materials, coatings, or finishes solely to protect either the reliability or the signature.
		LO-03	Equipment and support structure requiring shrouds to reduce radar returns should not cause increases in equipment service/repair time.
		LO-04	Infrequently-accessed structural doors and panels incorporating special coatings or conductive paints should contain provisions for prying the door or panel clear of moldline with standard screwdriver without damage.
		LO-05	Do not locate flush mounted LO screens for auxiliary air inlets and exits in walkway areas unless durability has been proven.
		LO-06	Size flush mounted LO screens for auxiliary air inlets and exits to ensure functionality with up to 25 percent of the openings plugged.
		LO-07	Flush and non-flush LO screens should be interchangeable.
		MATL-01	A high degree of durability should be maintained for a minimum distance of 36 inches forward of the inflight refueling receptacle.
		MATL-02	Cosmetic type repairs should not exceed 1 hours including cure or drying times.
		MATL-03	Cosmetic and vehicle repair material shelf life should not be less than 24 months.
		MATL-04	Cosmetic and vehicle repair materials should be non-proprietary and non-single source.
		MATL-05	Cosmetic and vehicle repair materials should not require refrigeration or special facilities or atmospheres for storage.

MIL-HDBK-470A

APPENDIX C

Guidelines by Category (Cont'd)

Category No.	Category Title	Guideline No.	Guideline
3.06.01	Antennas, Apertures, and Sensors	MATL-06	Repair criteria, repairs, and instructions should not be classified.
		MATL-07	All cosmetic touch-up and repair materials should be environmentally safe.
		MATL-08	Repairs (other than major repair) should not require autoclave type facilities.
		MATL-09	A high degree of durability should be achieved across all walkway areas on the top surfaces of all vehicles up to and including 95 percentile personnel.
		MATL-10	Coatings and finishes should be durable against the effects of missile gases, velocities, and particles emanating from the missile motor.
		MATL-11	Coatings and finishes should be durable against the effects of gun gases, projectile shock waves, and brass particles emanating from the projectile seal rings.
		MATL-12	Leading edge materials and coatings should be durable against fragments from frangible gun port plugs.
		MATL-13	Special handling or shipping requirements of repair materials should be avoided.
		MATL-14	Leading edges, including chines, containing or constructed of radar absorbing materials, should be interchangeable to reduce vehicle downtime and simplify repairs.
		MATL-15	Doors and panels containing blade seals used for signature reduction should be interchangeable or contain interchangeable blade seals. Deviation is acceptable where repairs can be accomplished on the vehicle in a time equal to or less than door or seal remove and replace time.
		MC-02	Avoid the use of cotter pins, safety wire, safety clips, and similar devices to prevent maintenance-induced events leading to ground vehicle accidents or loss of air vehicles.
		MC-06	Locate, position, orient all plumbing and duct electrical connectors to prevent the need for sequential installation or removal.
		MC-10	In rare instances where a plumbing run contains complex form or geometry that would require removal of other plumbing or equipment for access, in-line connectors should be incorporated to maintain the integrity of other plumbing or equipment.
		MC-12	All plumbing and connectors containing liquids should be meniscus-free.
		MC-14	Where multiple connectors are located in close proximity, ensure (1) a minimum hand tool arc of 120 degrees can be maintained, and (2) stagger fittings to ensure firm coupling interface/hand tool interface can be accomplished without inducing damage to adjacent lines.
		MG-02	Use a modular system design so that each subassembly is designed as a functionally complete entity. Then when a subassembly was removed for testing, ATE will not need custom circuitry to simulate missing functions.
		MP-01	Avoid the use of epoxies to mount parts on repairable modules because they make repair extremely difficult.
		MP-02	Use a unique identification (ID) resistor incorporated in each system module to verify that the proper module is mounted on ATE.
		MP-03	Design modules so that lengthy warm-up times, special coding and air purity levels, and similar constraints are not necessary.
		PERS-09	Design portable emergency locator beacons, radio receiver/transmitters, global positioning systems, and similar battery operated devices with integral provisions for determining battery health or status and remaining battery life.
		PYRO-26	Do not locate ammunition loader interfaces close to inlets, exhausts, fuel dumps and drains, antennas, sensors, lights, or hazardous protrusions.
		R-01	Large radomes wherein the combination of the diameter and length exceeds 60" should be top-hinged. Hinge should be load-carrying to reduce radome retention fastener count.
		R-02	Radome and radar array support structure design and material selection should eliminate the need for LO type fillers or shrouds.
		SABCH-06	Structural design should avoid the potential of dissimilar material or fastener corrosion.
		SABCH-07	No structural fasteners should be used that require special tools for installation.
		SABCH-08	Taper pins should be threaded and retained with self-locking hardware.
		SABCH-09	Pins and collars (lockbolts) should only be used in applications which do not normally require removal.

Guidelines by Category (Cont'd)

Category No.	Category Title	Guideline No.	Guideline
3.06.01	Antennas, Apertures, and Sensors	SABCH-10	Do not use lockbolts in composites.
		TP-01	Locate Input/Output (I/O) test points and associated readouts in close proximity to each other so that one person can perform testing.
		TP-02	Protect test points against the environment and from induced contamination.
		TP-03	Protect test points from outside signal generation.
		WIND-01	Optical window materials should be scratch resistant, easy to clean, and dissipate electrostatic charges.
		WIND-02	Optic windows should be located for ease of inspection, cleaning, and induced damage potential from personnel or support equipment.
		WIND-03	Window locations should minimize the effects of contamination by salt spray, bugs, oils, fuels, and icing.
		WIND-04	Window, canopy, and windshield material should be designed to withstand the effects of sandstorms in the ground environment and the effects of rain and hail during thunderstorm penetration in the airborne environment.
		WIND-05	Design interior surfaces to be reachable for cleaning without reliance on hinging, equipment removal, or use of support equipment.
		WIND-11	For dome-shaped optic window concepts, the dome should be easily removable for cleaning without affecting LO integrity.
		WIND-12	Design EO windows and optics to be interchangeable among the same air vehicle types or same ground vehicle types.
		WIND-13	The combination of material layers and coatings for optics and windows should be such that static charge buildup for worst case conditions should not exceed 10,000 volts.
		WIND-14	Exterior lights should permit simple and rapid bulb replacement without disturbing LO treatments.
		WIND-15	Design light covers and lenses to be sufficiently durable so that protective covers are not needed during maintenance.
WIND-16	Lens shape should enhance LO capability to reduce need, care, and expense for special coatings.		
3.06.02	Communications, Command and Control	A-11	Locate compartment electrical penetrations close to the access opening for ease of sight, probing, repair, and to eliminate fluid soaking, wicking, or contamination.
		A-12	Locate compartment electrical penetrations far enough from the access opening to prevent damage resulting from improper (over-length) panel fasteners.
		BIT-01	During design of the BIT, use worst-case stress analysis to ensure that any circuit failures induced by temperature extremes, tolerance build-up, power supply variations, and combinations thereof are identified.
		BIT-02	Ensure that BIT system thresholds are consistent with those across the system, subsystem, item, module, and piece-part levels to prevent excessive numbers of Cannot Duplicate (CND) and Retest OK (RTOK) events from occurring.
		BIT-03	The degree of BIT required or proposed should be based on the respective failure rates and the appropriate FMECA at all equipment indeture levels.
		BIT-04	Limit the amount of data that is recorded to a manageable size by: <ul style="list-style-type: none"> - Limiting the number of signals that are monitored - Limiting the maximum sampling rate - Reducing the time span over which data is accumulated - Restricting the type of data accumulated
		BIT-05	Incorporate testability design features as an integral part of equipment preliminary design process.
		BIT-06	Mission critical functions should be monitored by BIT.
		BIT-26	Locate routinely used test points so they are accessible without removing or disassembling other equipment
		CC-01	Use fiber-optic technologies in preference to conventional interconnect concepts to reduce the number of interconnects/interfaces, reduce manufacturing and ownership costs, and significantly improve R&M.
		CC-02	Standardize connector and wire types to improve testability and logistic support. Keep the number of "different" standard connectors to a minimum. Use the same connector type keyed differently where possible.
		CC-03	Provide clearance around connectors for engagement/disengagement of cables and proper connector orientation under anticipated environmental conditions (e.g., bare hand of 50 percentile male in an enclosed or protected environment and a gloved hand of a 50 percentile male in an open or unprotected environment).

Guidelines by Category (Cont'd)

Category No.	Category Title	Guideline No.	Guideline
3.06.02	Communications, Command and Control	CC-04	Use quick release cables and locate cables to make removal and replacement easy and to avoid having to remove one cable to gain access to another. Provide adequate space for cables, including sleeving and tie-downs, and adequate service loops for ease of assembly/disassembly
		CC-05	Orient and space connectors to allow a sufficient grip on the connector for cable or wire extraction without fear of using the wiring or cable for additional leverage.
		CC-06	Label, and where possible color code, each wire in a harness or cable to facilitate tracking from origin to termination. Each wire, cable, and coax-to-connector interface should be provided with a source of identification to aid in trouble shooting, repair, or modification. Marking the cable designer on the cable along with bar codes is also recommended.
		CC-07	Do not manufacture or dress connectors containing more than 25 wires or cables as a single integrated harness. Group the wires or cables into runs of no more than 25 wires or cables each. In addition to making trouble shooting and repair easier, this approach help avoid large bend radii, thereby simplifying routing, packaging, and stowage.
		CC-08	Standardize connector pin assignments for power, ground, and other frequently used signals.
		CC-09	Locate LRU/subsystem critical nodes (and or test points) so they are accessible from a connector to prevent the need for internal LRU probing or access.
		CC-10	Avoid hidden cables. Visually inspecting and tracing all assembly cables rather than having hidden cables (such as behind other cables or even LRUs) allows for a quick system and cable integrity check which aids in overall system integrity and debug. This also implies quick access for manipulative actions.
		CC-11	Orient spare wires and cable pigtailed along the outer diameter or periphery of connectors to make access easier.
		CC-12	Build up and assemble straight and angle connector shells or back shells in a manner that ensures that wire or cable strain or wear is not possible.
		EC-01	A threaded electrical connector should contain integral locking mechanisms and visual indications that the connector is properly seated and locked.
		EC-02	An electrical connector requiring less than one full turn to connect or disconnect should contain integral locking mechanisms and visual indications that the connector is properly seated and locked.
		EC-03	A push-pull electrical connector (excluding rack-and-panel type) should contain integral locking features and visual indication that the connector is properly seated and locked.
		EC-04	All electrical connectors should be keyed or asymmetrically shaped to ensure proper alignment.
		EC-05	All electrical connectors should contain scoop-proof shells to ensure pin damage will not occur prior to engaging key way.
		EC-06	All electrical connectors should be corrosion resistant to reduce or eliminate the need for scheduled inspections or corrosion prevention measures.
		EC-07	Avoid using electrical connectors requiring any type or form of soldering.
		EC-08	Locate and position electrical connectors such that all pin identification for either half can be easily seen.
		EC-09	Electrical connectors selected for critical applications on ground vehicles should be both accessible and capable of being connected disconnected by a fifty percentile gloved male hand.
		EC-10	Separation between grouped electrical connectors should be sufficient to ensure make or break of any connector by a fifty percentile gloved male hand. Where this is not possible, an alternate method should be used such as the use of stand-offs, long-shelled connectors alternated with standard connectors, 180-degree connectors alternated with 90-degree connectors, or innovative equivalents.
		EC-16	Select connectors so that contacts on the "live" or "hot" side of the connection are socket type rather than pin type to minimize personnel hazard and to prevent accidental shorting of live circuits.
		EC-17	Whenever possible, use self-locking connector plugs of a type not requiring safety wire.
		EC-18	All electric connectors should be environment resistant.
		EC-19	Connectors containing fiber optic contacts should, whenever possible, be mounted on a vertical surface to prevent particle and fluid contamination.
		EC-20	Use quick disconnect connectors where allowed and identify all pins on each connector.
		EC-21	Locate connectors far enough apart so that they meet specified requirements.

Guidelines by Category (Cont'd)

Category No.	Category Title	Guideline No.	Guideline
3.06.02	Communications, Command and Control	EC-22	All connectors should be keyed differently with aligning pins that extend beyond the electrical pins. Connector pins and sockets should engage after key position is entered.
		EC-23	Design connectors so that plugs are cold and receptacles are hot.
		EC-24	Use electrical connectors that incorporate alignment key-ways to reduce incidents of damage due to improper engagement.
		EC-25	Use positive locking, quick disconnect electrical connectors to save man-hours, prevent foreign object damage (FOD) and decrease the chance of personal injury.
		EC-26	Avoid using identical electrical connectors in adjacent areas.
		LO-03	Equipment and support structure requiring shrouds to reduce radar returns should not cause increases in equipment service/repair time.
		MC-02	Avoid the use of cotter pins, safety wire, safety clips, and similar devices to prevent maintenance-induced events leading to ground vehicle accidents or loss of air vehicles.
		MC-06	Locate, position, orient all plumbing and duct electrical connectors to prevent the need for sequential installation or removal.
		MC-10	In rare instances where a plumbing run contains complex form or geometry that would require removal of other plumbing or equipment for access, in-line connectors should be incorporated to maintain the integrity of other plumbing or equipment.
		MC-12	All plumbing and connectors containing liquids should be meniscus-free.
		MC-14	Where multiple connectors are located in close proximity, ensure (1) a minimum hand tool arc of 120 degrees can be maintained, and (2) stagger fittings to ensure firm coupling interface/hand tool interface can be accomplished without inducing damage to adjacent lines.
		MG-01	Mount LRUs/sub-systems on drawer slides or extender racks to provide easier accessibility during integration, testing, debug, and repair of Units Under Test (UUTs).
		MG-02	Use a modular system design so that each subassembly is designed as a functionally complete entity. Then when a subassembly was removed for testing, ATE will not need custom circuitry to simulate missing functions.
		MG-03	Clearly mark all subsystems/LRUs to make system integration, test, debug, and repair easier.
		MP-01	Avoid the use of epoxies to mount parts on repairable modules because they make repair extremely difficult.
		MP-02	Use a unique identification (ID) resistor incorporated in each system module to verify that the proper module is mounted on ATE.
		MP-03	Design modules so that lengthy warm-up times, special coding and air purity levels, and similar constraints are not necessary.
PERS-09	Design portable emergency locator beacons, radio receiver/transmitters, global positioning systems, and similar battery operated devices with integral provisions for determining battery health or status and remaining battery life.		
TP-01	Locate Input/Output (I/O) test points and associated readouts in close proximity to each other so that one person can perform testing.		
TP-02	Protect test points against the environment and from induced contamination.		
TP-03	Protect test points from outside signal generation.		
3.06.03	Computers	A-11	Locate compartment electrical penetrations close to the access opening for ease of sight, probing, repair, and to eliminate fluid soaking, wicking, or contamination.
		A-12	Locate compartment electrical penetrations far enough from the access opening to prevent damage resulting from improper (over-length) panel fasteners.
		BIT-01	During design of the BIT, use worst-case stress analysis to ensure that any circuit failures induced by temperature extremes, tolerance build-up, power supply variations, and combinations thereof are identified.
		BIT-02	Ensure that BIT system thresholds are consistent with those across the system, subsystem, item, module, and piece-part levels to prevent excessive numbers of Cannot Duplicate (CND) and Retest OK (RTOK) events from occurring.
		BIT-03	The degree of BIT required or proposed should be based on the respective failure rates and the appropriate FMECA at all equipment indenture levels.

Guidelines by Category (Cont'd)

Category No.	Category Title	Guideline No.	Guideline
3.06.03	Computers	BIT-04	Limit the amount of data that is recorded to a manageable size by: <ul style="list-style-type: none"> - Limiting the number of signals that are monitored - Limiting the maximum sampling rate - Reducing the time span over which data is accumulated - Restricting the type of data accumulated Incorporate testability design features as an integral part of equipment preliminary design process. Mission critical functions should be monitored by BIT. Use concurrent BIT to monitor system critical functions. Locate routinely used test points so they are accessible without removing or disassembling other equipment Use fiber-optic technologies in preference to conventional interconnect concepts to reduce the number of interconnects/interfaces, reduce manufacturing and ownership costs, and significantly improve R&M. Standardize connector and wire types to improve testability and logistic support. Keep the number of "different" standard connectors to a minimum. Use the same connector type keyed differently where possible. Provide clearance around connectors for engagement/disengagement of cables and proper connector orientation under anticipated environmental conditions (e.g., bare hand of 50 percentile male in an enclosed or protected environment and a gloved hand of a 50 percentile male in an open or unprotected environment). Use quick release cables and locate cables to make removal and replacement easy and to avoid having to remove one cable to gain access to another. Provide adequate space for cables, including sleeving and tie-downs, and adequate service loops for ease of assembly/disassembly Orient and space connectors to allow a sufficient grip on the connector for cable or wire extraction without fear of using the wiring or cable for additional leverage. Label, and where possible color code, each wire in a harness or cable to facilitate tracking from origin to termination. Each wire, cable, and coax-to-connector interface should be provided with a source of identification to aid in trouble shooting, repair, or modification. Marking the cable designer on the cable along with bar codes is also recommended. Do not manufacture or dress connectors containing more than 25 wires or cables as a single integrated harness. Group the wires or cables into runs of no more than 25 wires or cables each. In addition to making trouble shooting and repair easier, this approach help avoid large bend radii, thereby simplifying routing, packaging, and stowage. Standardize connector pin assignments for power, ground, and other frequently used signals. Locate LRU/subsystem critical nodes (and or test points) so they are accessible from a connector to prevent the need for internal LRU probing or access. Avoid hidden cables. Visually inspecting and tracing all assembly cables rather than having hidden cables (such as behind other cables or even LRUs) allows for a quick system and cable integrity check which aids in overall system integrity and debug. This also implies quick access for manipulative actions. Orient spare wires and cable pigtailed along the outer diameter or periphery of connectors to make access easier. Build up and assemble straight and angle connector shells or back shells in a manner that ensures that wire or cable strain or wear is not possible. Design automated systems and programs with provisions to enable "stop test" and "resume" without the need to cycle back or repeat the entire test. In the event of program loss or hang-up, automated systems and programs should have provisions for reverting to manual test and operation. Use a test connector to provide test and maintenance bus access to all system and subsystem faults. Design systems and subsystems so that ATE can be used to access, read, and control internal components in concert with the test or checkout program. Avoid the need for costly adapters for signal communications between system, subsystems, line replaceable units (LRUs) or Weapon Replaceable Assemblies (WRAs), and ATE. A threaded electrical connector should contain integral locking mechanisms and visual indications that the connector is properly seated and locked.
		BIT-05	
		BIT-06	
		BIT-09	
		BIT-26	
		CC-01	
		CC-02	
		CC-03	
		CC-04	
		CC-05	
		CC-06	
		CC-07	
		CC-08	
		CC-09	
		CC-10	
		CC-11	
		CC-12	
		CO-01	
		CO-02	
		CO-03	
		CO-04	
		CO-05	
		EC-01	

Guidelines by Category (Cont'd)

Category No.	Category Title	Guideline No.	Guideline
3.06.03	Computers	EC-02	An electrical connector requiring less than one full turn to connect or disconnect should contain integral locking mechanisms and visual indications that the connector is properly seated and locked.
		EC-03	A push-pull electrical connector (excluding rack-and-panel type) should contain integral locking features and visual indication that the connector is properly seated and locked.
		EC-04	All electrical connectors should be keyed or asymmetrically shaped to ensure proper alignment.
		EC-05	All electrical connectors should contain scoop-proof shells to ensure pin damage will not occur prior to engaging key way.
		EC-06	All electrical connectors should be corrosion resistant to reduce or eliminate the need for scheduled inspections or corrosion prevention measures.
		EC-07	Avoid using electrical connectors requiring any type or form of soldering.
		EC-08	Locate and position electrical connectors such that all pin identification for either half can be easily seen.
		EC-09	Electrical connectors selected for critical applications on ground vehicles should be both accessible and capable of being connected disconnected by a fifty percentile gloved male hand.
		EC-10	Separation between grouped electrical connectors should be sufficient to ensure make or break of any connector by a fifty percentile gloved male hand. Where this is not possible, an alternate method should be used such as the use of stand-offs, long-shelled connectors alternated with standard connectors, 180-degree connectors alternated with 90-degree connectors, or innovative equivalents.
		EC-16	Select connectors so that contacts on the "live" or "hot" side of the connection are socket type rather than pin type to minimize personnel hazard and to prevent accidental shorting of live circuits.
		EC-17	Whenever possible, use self-locking connector plugs of a type not requiring safety wire.
		EC-18	All electric connectors should be environment resistant.
		EC-19	Connectors containing fiber optic contacts should, whenever possible, be mounted on a vertical surface to prevent particle and fluid contamination.
		EC-21	Locate connectors far enough apart so that they meet specified requirements.
		EC-22	All connectors should be keyed differently with aligning pins that extend beyond the electrical pins. Connector pins and sockets should engage after key position is entered.
		EC-23	Design connectors so that plugs are cold and receptacles are hot.
		EC-24	Use electrical connectors that incorporate alignment key-ways to reduce incidents of damage due to improper engagement.
		EC-25	Use positive locking, quick disconnect electrical connectors to save man-hours, prevent foreign object damage (FOD) and decrease the chance of personal injury.
		EC-26	Avoid using identical electrical connectors in adjacent areas.
		LO-03	Equipment and support structure requiring shrouds to reduce radar returns should not cause increases in equipment service/repair time.
		MC-06	Locate, position, orient all plumbing and duct electrical connectors to prevent the need for sequential installation or removal.
		MC-12	All plumbing and connectors containing liquids should be meniscus-free.
		MC-14	Where multiple connectors are located in close proximity, ensure (1) a minimum hand tool arc of 120 degrees can be maintained, and (2) stagger fittings to ensure firm coupling interface/hand tool interface can be accomplished without inducing damage to adjacent lines.
		MG-01	Mount LRUs/sub-systems on drawer slides or extender racks to provide easier accessibility during integration, testing, debug, and repair of Units Under Test (UUTs).
		MG-02	Use a modular system design so that each subassembly is designed as a functionally complete entity. Then when a subassembly was removed for testing, ATE will not need custom circuitry to simulate missing functions.
		MG-03	Clearly mark all subsystems/LRUs to make system integration, test, debug, and repair easier.
		MP-01	Avoid the use epoxies to mount parts on repairable modules because they make repair extremely difficult.

Guidelines by Category (Cont'd)

Category No.	Category Title	Guideline No.	Guideline
3.06.03	Computers	MP-02	Use a unique identification (ID) resistor incorporated in each system module to verify that the proper module is mounted on ATE.
		MP-03	Design modules so that lengthy warm-up times, special coding and air purity levels, and similar constraints are not necessary.
		TP-01	Locate Input/Output (I/O) test points and associated readouts in close proximity to each other so that one person can perform testing.
		TP-02	Protect test points against the environment and from induced contamination.
		TP-03	Protect test points from outside signal generation.
3.06.04	Power Supply	A-11	Locate compartment electrical penetrations close to the access opening for ease of sight, probing, repair, and to eliminate fluid soaking, wicking, or contamination.
		A-12	Locate compartment electrical penetrations far enough from the access opening to prevent damage resulting from improper (over-length) panel fasteners.
		BIT-01	During design of the BIT, use worst-case stress analysis to ensure that any circuit failures induced by temperature extremes, tolerance build-up, power supply variations, and combinations thereof are identified.
		BIT-02	Ensure that BIT system thresholds are consistent with those across the system, subsystem, item, module, and piece-part levels to prevent excessive numbers of Cannot Duplicate (CND) and Retest OK (RTOK) events from occurring.
		BIT-03	The degree of BIT required or proposed should be based on the respective failure rates and the appropriate FMECA at all equipment indenture levels.
		BIT-04	Limit the amount of data that is recorded to a manageable size by: <ul style="list-style-type: none"> - Limiting the number of signals that are monitored - Limiting the maximum sampling rate - Reducing the time span over which data is accumulated - Restricting the type of data accumulated
		BIT-05	Incorporate testability design features as an integral part of equipment preliminary design process.
		BIT-06	Mission critical functions should be monitored by BIT.
		BIT-09	Use concurrent BIT to monitor system critical functions.
		BIT-26	Locate routinely used test points so they are accessible without removing or disassembling other equipment
		CC-01	Use fiber-optic technologies in preference to conventional interconnect concepts to reduce the number of interconnects/interfaces, reduce manufacturing and ownership costs, and significantly improve R&M.
		CC-02	Standardize connector and wire types to improve testability and logistic support. Keep the number of "different" standard connectors to a minimum. Use the same connector type keyed differently where possible.
		CC-03	Provide clearance around connectors for engagement/disengagement of cables and proper connector orientation under anticipated environmental conditions (e.g., bare hand of 50 percentile male in an enclosed or protected environment and a gloved hand of a 50 percentile male in an open or unprotected environment).
		CC-04	Use quick release cables and locate cables to make removal and replacement easy and to avoid having to remove one cable to gain access to another. Provide adequate space for cables, including sleeving and tie-downs, and adequate service loops for ease of assembly/disassembly
		CC-05	Orient and space connectors to allow a sufficient grip on the connector for cable or wire extraction without fear of using the wiring or cable for additional leverage.
		CC-06	Label, and where possible color code, each wire in a harness or cable to facilitate tracking from origin to termination. Each wire, cable, and coax-to-connector interface should be provided with a source of identification to aid in trouble shooting, repair, or modification. Marking the cable designator on the cable along with bar codes is also recommended.
		CC-07	Do not manufacture or dress connectors containing more than 25 wires or cables as a single integrated harness. Group the wires or cables into runs of no more than 25 wires or cables each. In addition to making trouble shooting and repair easier, this approach help avoid large bend radii, thereby simplifying routing, packaging, and stowage.
		CC-08	Standardize connector pin assignments for power, ground, and other frequently used signals.

Guidelines by Category (Cont'd)

Category No.	Category Title	Guideline No.	Guideline
3.06.04	Power Supply	CC-09	Locate LRU/subsystem critical nodes (and or test points) so they are accessible from a connector to prevent the need for internal LRU probing or access.
		CC-10	Avoid hidden cables. Visually inspecting and tracing all assembly cables rather than having hidden cables (such as behind other cables or even LRUs) allows for a quick system and cable integrity check which aids in overall system integrity and debug. This also implies quick access for manipulative actions.
		CC-11	Orient spare wires and cable pigtails along the outer diameter or periphery of connectors to make access easier.
		CC-12	Build up and assemble straight and angle connector shells or back shells in a manner that ensures that wire or cable strain or wear is not possible.
		CO-01	Design automated systems and programs with provisions to enable "stop test" and "resume" without the need to cycle back or repeat the entire test.
		CO-02	In the event of program loss or hang-up, automated systems and programs should have provisions for reverting to manual test and operation.
		CO-03	Use a test connector to provide test and maintenance bus access to all system and subsystem faults.
		CO-04	Design systems and subsystems so that ATE can be used to access, read, and control internal components in concert with the test or checkout program.
		CO-05	Avoid the need for costly adapters for signal communications between system, subsystems, line replaceable units (LRUs) or Weapon Replaceable Assemblies (WRAs), and ATE.
		EC-01	A threaded electrical connector should contain integral locking mechanisms and visual indications that the connector is properly seated and locked.
		EC-02	An electrical connector requiring less than one full turn to connect or disconnect should contain integral locking mechanisms and visual indications that the connector is properly seated and locked.
		EC-03	A push-pull electrical connector (excluding rack-and-panel type) should contain integral locking features and visual indication that the connector is properly seated and locked.
		EC-04	All electrical connectors should be keyed or asymmetrically shaped to ensure proper alignment.
		EC-05	All electrical connectors should contain scoop-proof shells to ensure pin damage will not occur prior to engaging key way.
		EC-06	All electrical connectors should be corrosion resistant to reduce or eliminate the need for scheduled inspections or corrosion prevention measures.
		EC-07	Avoid using electrical connectors requiring any type or form of soldering.
		EC-08	Locate and position electrical connectors such that all pin identification for either half can be easily seen.
		EC-09	Electrical connectors selected for critical applications on ground vehicles should be both accessible and capable of being connected disconnected by a fifty percentile gloved male hand.
		EC-10	Separation between grouped electrical connectors should be sufficient to ensure make or break of any connector by a fifty percentile gloved male hand. Where this is not possible, an alternate method should be used such as the use of stand-offs, long-shelled connectors alternated with standard connectors, 180-degree connectors alternated with 90-degree connectors, or innovative equivalents.
		EC-16	Select connectors so that contacts on the "live" or "hot" side of the connection are socket type rather than pin type to minimize personnel hazard and to prevent accidental shorting of live circuits.
		EC-17	Whenever possible, use self-locking connector plugs of a type not requiring safety wire.
		EC-18	All electric connectors should be environment resistant.
		EC-19	Connectors containing fiber optic contacts should, whenever possible, be mounted on a vertical surface to prevent particle and fluid contamination.
		EC-20	Use quick disconnect connectors where allowed and identify all pins on each connector.
		EC-21	Locate connectors far enough apart so that they meet specified requirements.
		EC-22	All connectors should be keyed differently with aligning pins that extend beyond the electrical pins. Connector pins and sockets should engage after key position is entered.

Guidelines by Category (Cont'd)

Category No.	Category Title	Guideline No.	Guideline
3.06.04	Power Supply	EC-23	Design connectors so that plugs are cold and receptacles are hot.
		EC-24	Use electrical connectors that incorporate alignment key-ways to reduce incidents of damage due to improper engagement.
		EC-25	Use positive locking, quick disconnect electrical connectors to save man-hours, prevent foreign object damage (FOD) and decrease the chance of personal injury.
		EC-26	Avoid using identical electrical connectors in adjacent areas.
		LO-03	Equipment and support structure requiring shrouds to reduce radar returns should not cause increases in equipment service/repair time.
		MC-06	Locate, position, orient all plumbing and duct electrical connectors to prevent the need for sequential installation or removal.
		MC-12	All plumbing and connectors containing liquids should be meniscus-free.
		MC-14	Where multiple connectors are located in close proximity, ensure (1) a minimum hand tool arc of 120 degrees can be maintained, and (2) stagger fittings to ensure firm coupling interface/hand tool interface can be accomplished without inducing damage to adjacent lines.
		MG-03	Clearly mark all subsystems/LRUs to make system integration, test, debug, and repair easier.
		MP-01	Avoid the use of epoxies to mount parts on repairable modules because they make repair extremely difficult.
		MP-02	Use a unique identification (ID) resistor incorporated in each system module to verify that the proper module is mounted on ATE.
		MP-03	Design modules so that lengthy warm-up times, special coding and air purity levels, and similar constraints are not necessary.
		TP-01	Locate Input/Output (I/O) test points and associated readouts in close proximity to each other so that one person can perform testing.
		TP-02	Protect test points against the environment and from induced contamination.
TP-03	Protect test points from outside signal generation.		
3.06.05	Information Systems	A-11	Locate compartment electrical penetrations close to the access opening for ease of sight, probing, repair, and to eliminate fluid soaking, wicking, or contamination.
		A-12	Locate compartment electrical penetrations far enough from the access opening to prevent damage resulting from improper (over-length) panel fasteners.
		BIT-01	During design of the BIT, use worst-case stress analysis to ensure that any circuit failures induced by temperature extremes, tolerance build-up, power supply variations, and combinations thereof are identified.
		BIT-02	Ensure that BIT system thresholds are consistent with those across the system, subsystem, item, module, and piece-part levels to prevent excessive numbers of Cannot Duplicate (CND) and Retest OK (RTOK) events from occurring.
		BIT-03	The degree of BIT required or proposed should be based on the respective failure rates and the appropriate FMECA at all equipment indenture levels.
		BIT-04	Limit the amount of data that is recorded to a manageable size by: <ul style="list-style-type: none"> - Limiting the number of signals that are monitored - Limiting the maximum sampling rate - Reducing the time span over which data is accumulated - Restricting the type of data accumulated
		BIT-05	Incorporate testability design features as an integral part of equipment preliminary design process.
		BIT-06	Mission critical functions should be monitored by BIT.
		BIT-07	Set BIT tolerances to maximize fault detection and minimize false alarm rate in the expected operating environment.
		BIT-08	Design BIT fault detectors to accommodate the needs of operator maintenance personnel.
BIT-09	Use concurrent BIT to monitor system critical functions.		
BIT-10	Design the BIT and BITE so that no fault or failure within the BIT or BITE will degrade, disrupt, or fail the system being monitored.		

Guidelines by Category (Cont'd)

Category No.	Category Title	Guideline No.	Guideline
3.06.05	Information Systems	BIT-11	In the area of software design and test responsibility, the responsibility for the design and development of verification testing of an end item (e.g., digital filter) should reside with the same engineer(s).
		BIT-12	Define stimuli and response data for each diagnostic test at the system/subsystem level. The same data should be planned for use both in factory testing as well as in field maintenance of the equipment. These data minimize the amount of unique software to be written.
		BIT-13	Provide for manual control to test sequences, so that the test can be selected individually, and appropriate test combinations can be executed at the operator's discretion.
		BIT-14	Provide access to all BIT control and status signals at module connector pins. This will enable ATE to directly connect to BIT circuitry.
		BIT-15	Incorporate complete BIT functions and BITE on module. If only a portion of the BIT routine or BITE circuitry exists on the module, then ATE cannot utilize the BIT routine without providing the missing BIT functions.
		BIT-17	BIT failures should be latched on the module. This makes it easier for the system or ATE to poll the error bit at any time.
		BIT-18	If many BIT routines exist on a module, then ATE should have access and the ability to control each routine individually.
		BIT-19	Design BIT to have a very low false alarm rate; otherwise BIT will not be an effective maintenance tool. As a goal, the false alarm rate should be 1% or less.
		BIT-20	The BIT should be mechanized so that when a piece of equipment is not installed in a subsystem or the product, a failure will not be indicated.
		BIT-26	Locate routinely used test points so they are accessible without removing or disassembling other equipment
		CC-06	Label, and where possible color code, each wire in a harness or cable to facilitate tracking from origin to termination. Each wire, cable, and coax-to-connector interface should be provided with a source of identification to aid in trouble shooting, repair, or modification. Marking the cable designator on the cable along with bar codes is also recommended.
		CC-07	Do not manufacture or dress connectors containing more than 25 wires or cables as a single integrated harness. Group the wires or cables into runs of no more than 25 wires or cables each. In addition to making trouble shooting and repair easier, this approach help avoid large bend radii, thereby simplifying routing, packaging, and stowage.
		CC-08	Standardize connector pin assignments for power, ground, and other frequently used signals.
		CC-09	Locate LRU/subsystem critical nodes (and or test points) so they are accessible from a connector to prevent the need for internal LRU probing or access.
		CC-10	Avoid hidden cables. Visually inspecting and tracing all assembly cables rather than having hidden cables (such as behind other cables or even LRUs) allows for a quick system and cable integrity check which aids in overall system integrity and debug. This also implies quick access for manipulative actions.
		CO-01	Design automated systems and programs with provisions to enable "stop test" and "resume" without the need to cycle back or repeat the entire test.
		CO-02	In the event of program loss or hang-up, automated systems and programs should have provisions for reverting to manual test and operation.
		CO-03	Use a test connector to provide test and maintenance bus access to all system and subsystem faults.
		CO-04	Design systems and subsystems so that ATE can be used to access, read, and control internal components in concert with the test or checkout program.
		CO-05	Avoid the need for costly adapters for signal communications between system, subsystems, line replaceable units (LRUs) or Weapon Replaceable Assemblies (WRAs), and ATE.
		EC-01	A threaded electrical connector should contain integral locking mechanisms and visual indications that the connector is properly seated and locked.
		EC-02	An electrical connector requiring less than one full turn to connect or disconnect should contain integral locking mechanisms and visual indications that the connector is properly seated and locked.
		EC-03	A push-pull electrical connector (excluding rack-and-panel type) should contain integral locking features and visual indication that the connector is properly seated and locked.
		EC-04	All electrical connectors should be keyed or asymmetrically shaped to ensure proper alignment.

Guidelines by Category (Cont'd)

Category No.	Category Title	Guideline No.	Guideline
3.06.05	Information Systems		
		EC-05	All electrical connectors should contain scoop-proof shells to ensure pin damage will not occur prior to engaging key way.
		EC-06	All electrical connectors should be corrosion resistant to reduce or eliminate the need for scheduled inspections or corrosion prevention measures.
		EC-07	Avoid using electrical connectors requiring any type or form of soldering.
		EC-08	Locate and position electrical connectors such that all pin identification for either half can be easily seen.
		EC-09	Electrical connectors selected for critical applications on ground vehicles should be both accessible and capable of being connected disconnected by a fifty percentile gloved male hand.
		EC-10	Separation between grouped electrical connectors should be sufficient to ensure make or break of any connector by a fifty percentile gloved male hand. Where this is not possible, an alternate method should be used such as the use of stand-offs, long-shelled connectors alternated with standard connectors, 180-degree connectors alternated with 90-degree connectors, or innovative equivalents.
		EC-11	Avoid connectors requiring potting as a method for environmental protection due to lengthy repair time and tendency for potting compound reversion.
		EC-12	Electrical penetrations into a compartment should not be on a vertical axis to ensure foreign matter does not enter connector.
		EC-15	The removal or replacement of electronic equipment should not require the removal of any other piece of equipment or armament.
		EC-21	Locate connectors far enough apart so that they meet specified requirements.
		EC-22	All connectors should be keyed differently with aligning pins that extend beyond the electrical pins. Connector pins and sockets should engage after key position is entered.
		EC-23	Design connectors so that plugs are cold and receptacles are hot.
		EC-24	Use electrical connectors that incorporate alignment key-ways to reduce incidents of damage due to improper engagement.
		EC-25	Use positive locking, quick disconnect electrical connectors to save man-hours, prevent foreign object damage (FOD) and decrease the chance of personal injury.
		EC-26	Avoid using identical electrical connectors in adjacent areas.
		ENG-01	All facets of engine design should take advantage of Electrostatic Engine Monitoring Systems (EEMS) and Inductive Debris Monitoring (IDM) toward achievement of on-condition maintenance and engine health monitoring.
		ENG-02	Each different component of rotating machinery should contain different tracer elements to enhance EEMS and IDM isolation and tracking of wear.
		ENG-03	Digital electronic controls, fully automatic digital electronic controls, and similar concepts should contain the highest degree of BIT and diagnostics commensurate with affordability, operation and maintenance, and life cycle costs as appropriate.
		ENG-26	Locate and position engine overheat and fire warning sensors so that damage cannot occur during engine maintenance or replacement.
		LO-03	Equipment and support structure requiring shrouds to reduce radar returns should not cause increases in equipment service/repair time.
		MG-01	Mount LRUs/sub-systems on drawer slides or extender racks to provide easier accessibility during integration, testing, debug, and repair of Units Under Test (UUTs).
		MG-02	Use a modular system design so that each subassembly is designed as a functionally complete entity. Then when a subassembly was removed for testing, ATE will not need custom circuitry to simulate missing functions.
		MG-03	Clearly mark all subsystems/LRUs to make system integration, test, debug, and repair easier.
		MP-01	Avoid the use epoxies to mount parts on repairable modules because they make repair extremely difficult.
		MP-02	Use a unique identification (ID) resistor incorporated in each system module to verify that the proper module is mounted on ATE.

Guidelines by Category (Cont'd)

Category No.	Category Title	Guideline No.	Guideline
3.06.05	Information Systems	MP-03	Design modules so that lengthy warm-up times, special coding and air purity levels, and similar constraints are not necessary.
		PYRO-10	Provide a numerical maintenance code on maintenance panels or maintenance recorder/memory systems to denote the "safe/arm" status for each weapon or store.
		TP-01	Locate Input/Output (I/O) test points and associated readouts in close proximity to each other so that one person can perform testing.
		TP-02	Protect test points against the environment and from induced contamination.
		TP-03	Protect test points from outside signal generation.
3.07	Environmental Control, Air Conditioning, and Pressurization	A-03	All equipment bay and compartment structural flanges and stiffeners should be external to the compartment to maximize the volume available for equipment installation and arrangement.
		A-04	Use stiffening beads in lieu of flanges to the maximum extent to enhance compartment volume and simplify repairs.
		A-05	Stiffening beads should have the convex surface toward the compartment to eliminate fluid traps.
		A-06	Keep all machined compartment frames, webs, and closure panels to a constant thickness (e.g., not stepped or tapered) to ease simplicity of fluid or electrical penetrations and ease and simplicity of structural repair.
		A-07	Hardpoints (structural attachment and load bearing areas) within a compartment to assist in equipment mounting or support should not be integral with the machined part. Hardpoints should be parasitic to enable quick repair in case of wear or damage in lieu of precise ream/bush repair typical of machined hardpoints.
		A-08	Paint equipment bay and compartment interiors a high gloss white to maximize lighting reflectivity, visibility, and rapid leak detection capability.
		A-09	Plumbing penetrations into a compartment should not be on a vertical axis due to difficulty in making or breaking vertically-oriented connections. When compartment access is from the bottom, vertically-oriented connections can allow fluid to leak onto the maintainer. When access is from the top, such connections can allow foreign matter to enter the line. Use horizontal penetrations whenever possible.
		A-10	Any heat or temperature sensitive structure within a compartment should contain heat-sensitive tape or appropriate heat sensor for easy indication of over-temperature excursions.
		A-11	Provide a sufficient number of compartment fluid drains to ensure fluid drainage for varying aircraft static attitudes and varying terrain slopes for ground vehicles.
		A-12	Locate compartment electrical penetrations close to the access opening for ease of sight, probing, repair, and to eliminate fluid soaking, wicking, or contamination.
		A-13	Locate compartment electrical penetrations far enough from the access opening to prevent damage resulting from improper (over-length) panel fasteners.
		A-14	Two-sided or two-surfaced access should not be required for access to equipment interfaces and hardpoints. The term two-sided infers top/bottom, left/right, front/back, or combinations thereof.
		A-18	Do not locate nutplates or gang channels in inaccessible areas that would require extensive disassembly or equipment removal to gain access.
		BIT-01	Use transparent windows, quick-opening covers, or openings without any cover to permit quick visual inspections where needed.
		BIT-02	During design of the BIT, use worst-case stress analysis to ensure that any circuit failures induced by temperature extremes, tolerance build-up, power supply variations, and combinations thereof are identified.
		BIT-03	Ensure that BIT system thresholds are consistent with those across the system, subsystem, item, module, and piece-part levels to prevent excessive numbers of Cannot Duplicate (CND) and Retest OK (RTOK) events from occurring.
			The degree of BIT required or proposed should be based on the respective failure rates and the appropriate FMECA at all equipment indenture levels.

Guidelines by Category (Cont'd)

Category No.	Category Title	Guideline No.	Guideline
3.07	Environmental Control, Air Conditioning, and Pressurization	BIT-04	Limit the amount of data that is recorded to a manageable size by: <ul style="list-style-type: none"> - Limiting the number of signals that are monitored - Limiting the maximum sampling rate - Reducing the time span over which data is accumulated - Restricting the type of data accumulated Incorporate testability design features as an integral part of equipment preliminary design process. Mission critical functions should be monitored by BIT. Use concurrent BIT to monitor system critical functions. Critical voltages should be visually monitored by sending the voltage signals to visible LEDs. BIT failures should be latched on the module. This makes it easier for the system or ATE to poll the error bit at any time. If many BIT routines exist on a module, then ATE should have access and the ability to control each routine individually. Design BIT to have a very low false alarm rate; otherwise BIT will not be an effective maintenance tool. As a goal, the false alarm rate should be 1% or less. The BIT should be mechanized so that when a piece of equipment is not installed in a subsystem or the product, a failure will not be indicated. Locate routinely used test points so they are accessible without removing or disassembling other equipment. Orient all vehicle liquid servicing fittings to ensure fluids will not come in contact with protective garb during connect/disconnect activities. Control rods should use Boyd or impedance type bolts (or equivalent) to eliminate the need for cotter pins or safety wire. Do not use metal control cables for vehicles that will operate in salt water or salt air environments. Use control rods rather than control cables for non-complex applications and non-complex routing within the vehicle. Use control cables rather than control rods for most complex applications. Route cables so that 100 percent of a cable will be viewable for inspection. Design all pulleys and brackets associated with cable installations so they are accessible by a 75 percentile male hand. Avoid wiring, coax, and plumbing penetrations through the floor of crew cabs, operators' compartments, crew stations, cockpits, and passenger compartments. The geometric aspects of structural design and interfaces should not result in any natural bathtubs. Closed structural sections subject to condensation or fluid migration should contain drainage provisions. Crew cabs, operators' compartments, crew stations, cockpits, and passenger compartments should be subject to the same corrosion prevention measures as the exteriors of the vehicles. Low points, pockets, and related fluid collection points within should be provided with low point drains. Design so that equipment servicing status are accessible and readable from the ground level for air vehicles and from the operator's position for ground and water vehicles. Do not locate equipment servicing points in crew, passenger, or operator areas. Heat exchangers using hot liquids as the heat source should not be located inside the compartments used for operator, crew, or passengers. Plumbing, lines, or hoses containing hot liquids, toxic gases or liquids should be external to operator, crew, or passenger stations. Access, removal, and installation of all type filter elements should be possible without removing the assembly or disconnecting any filter package interfaces. All electrical control, sensing, sensor, warning, caution, or signal interface and wiring should be fully BIT compatible. Liquid type refrigeration compressors/packages should contain highly reliable quick disconnects to negate servicing or bleeding subsequent to replacement. All liquid type refrigeration compressors and packages stocked as spares should be pre-serviced wherein the servicing is compatible with the shelf life of the unit. Design control valves, both manual and powered, with a visual pointer that clearly indicates the position of the valve.
		BIT-05	
		BIT-06	
		BIT-09	
		BIT-16	
		BIT-17	
		BIT-18	
		BIT-19	
		BIT-20	
		BIT-26	
		CBR-01	
		CONT-01	
		CONT-02	
		CONT-03	
		CONT-04	
		CONT-05	
		CONT-06	
		CREW-04	
		D&V-01	
		D&V-02	
		D&V-03	
		ECS-01	
		ECS-02	
		ECS-03	
		ECS-04	
		ECS-05	
		ECS-06	
		ECS-07	
		ECS-08	
		ECS-09	

Guidelines by Category (Cont'd)

Category No.	Category Title	Guideline No.	Guideline
3.07	Environmental Control, Air Conditioning, and Pressurization	ECS-10	The power actuation source used for valves that direct or control air, gas, or liquid flow should be parasitic to the valve body to enable replacement without disturbing the integrity of the lines, ducts, or plenums.
		ECS-11	Design air inlets, outlets, and exhausts to be accessible without reliance on ladders or work stands for ease of installing protective plugs or covers.
		ECS-12	Design air inlets, outlets, and exhausts with screens to prevent bird or rodent entry.
		ECS-13	Design air inlets, outlets, and exhausts to be meniscus-free to prevent a bathtub effect. In remote instances where this is not possible, passive drains should be provided at all low points to prevent liquid accumulation with the vehicle in its normal static attitude.
		ECS-14	Instances where air inlets, outlets, and exhausts are subject to water entry, passive drains should be employed capable of handling 4" of rain per hour.
		ECS-15	Locate and orient air inlets, outlets, and exhausts in a manner that prevents their use as footholds during maintenance.
		ECS-16	All components contained in the systems, including all attaching brackets and supports, should use hex-head self-locking bolts for ease and simplicity of installation.
		ECS-17	Do not use air ejectors due to their low reliability and susceptibility to clogging.
		ECS-18	Avoid the use of insulation blankets containing polyvinyl for any application due to the dense smoke and toxic fumes if burned or subjected to high temperature bleed air leakage.
		ECS-19	Thermal blankets and covers used in ground vehicles should be replaceable.
		ECS-20	Minor rips, tears, and punctures in ground vehicle thermal blankets and covers should be capable of being repaired in place.
		ECS-21	Do not locate ground cooling or circulation fans that operate at high noise levels in operator, crew, or passenger compartments.
		ECS-22	There should be no requirements for scheduled servicing or lubrication.
		ECS-24	System design and integration and technology application should be such that requirements for torque is not required.
		ECS-25	Technology, material selection, and treatments should combine to provide a corrosion-resistant system.
		ECS-26	Design and integrate components whose proper operation depends on the direction of flow such that they cannot be incorrectly installed.
		ECS-27	Use temperature-limiting devices with high temperature air systems to ensure no single or combination of surface wind, cross wind, ground operation or flight operation will damage windshields, canopies, windows or optics.
		ECS-28	Install and orient air supply and distribution ducts so they clear all access openings and equipment removal envelopes.
		EDECOM-02	Provide integral sensors (viewable from the exterior) for equipment subject to internal forced-air cooling from outside or external air to indicate the presence of contaminants.
		ENG(G)-06	The distance between the engine and firewall should ensure the access envelopes to lines, fittings, wiring, and adjustments will accommodate the 75 percentile male hand.
		ENG(G)-10	Design attaching hardware for all mechanical engine-to-vehicle interfaces to be captive and with integral safeties.
		ENG(G)-11	Use "torq-set" type clamps or equivalent in all cooling system hose interfaces to eliminate torque wrenches and the potential for error.
		ENG(G)-14	Access envelopes to fuel and oil filters should not be in close proximity to exhaust manifolds or cooling system return lines.
		ENG(G)-15	Any single drive belt (excluding timing belts) should be capable of replacement within 30 minutes elapsed time
		ENG(G)-17	Install simple, lightweight shields over cooling system return lines to protect personnel from hose or line blowout during maintenance.

Guidelines by Category (Cont'd)

Category No.	Category Title	Guideline No.	Guideline
3.07	Environmental Control, Air Conditioning, and Pressurization	ENG(G)-18	Incorporate appropriate sensors to enhance the diagnostic and prognostic capabilities for the following: <ul style="list-style-type: none"> - Fuel filter bypass - Coolant pressure - Coolant level - Coolant temperature - Vibration pickups - Chip detector
		ENG-27	No rigging or calibration should be required following engine replacement.
		ENG-28	No engine operational start and checkout should be required following engine replacement.
		ENG-47	Design the engine, including all accessories, plumbing, wiring, ducts, and mechanisms, to meet the same environmental protection and compatibility requirements as the host vehicle.
		ENV-01	Materials, treatments, coatings, finishes should be compatible with all anti-ice and de-ice fluids, chemical and biological decontamination fluids, washing and cleaning fluids, and all vehicle subsystem fluids.
		ENV-02	There should be no top coat or treatment deterioration throughout the standard temperature and humidity spectrum.
		ENV-03	For airborne vehicles, the finishes should be durable against rain, hail, and dynamic erosion throughout the flight envelope.
		ENV-04	For airborne and ground vehicles, the finishes should be durable against sand erosion throughout all surface wind speeds experienced in arid or desert geographical locations.
		HYD-09	Provide hydraulic devices used in critical applications with integral 5 micron filtering.
		LO-06	Size flush mounted LO screens for auxiliary air inlets and exits to ensure functionality with up to 25 percent of the openings plugged.
		LO-07	Flush and non-flush LO screens should be interchangeable.
		MC-01	All clamps should contain torque-set or torque-limiting connections to prevent clamp or component failure due to over-torque. Clamp installation call outs should not depend on special tools to establish the required torque values.
		MC-02	Avoid the use of cotter pins, safety wire, safety clips, and similar devices to prevent maintenance-induced events leading to ground vehicle accidents or loss of air vehicles.
		MC-03	All tubing connections and interfaces should use rosan/dynatube (or equivalent) to (1) enable connect or disconnect with one hand, one tool, (2) eliminate the need to safety the connection, (3) provide a superior seal, and (4) negate need to reposition line(s) during component replacement.
		MC-04	No trombone type, flared tube type, or piloted line type interfaces should be used to avoid the need for removal or repositioning during equipment removal.
		MC-05	Avoid potential foreign object traps during manufacturing or operational maintenance by eliminating vertical penetrations of plumbing/fittings into tanks, compartments, or cells
		MC-06	Locate, position, orient all plumbing and duct electrical connectors to prevent the need for sequential installation or removal.
		MC-09	All plumbing connections and fittings used for fuel systems should contain integral bonding features to eliminate the need for bonding clamps or jumper cables.
		MC-10	In rare instances where a plumbing run contains complex form or geometry that would require removal of other plumbing or equipment for access, in-line connectors should be incorporated to maintain the integrity of other plumbing or equipment.
		MC-11	No subsystem plumbing, equipment, or wiring should use a tank, cell, or compartment containing liquids as a means for routing or penetration simplicity during manufacture.
		MC-12	All plumbing and connectors containing liquids should be meniscus-free.
		MC-13	In instances where plumbing or connector interfaces cannot or are not keyed for a specific orientation, all identification, markings, cautions, and directions should be placed 360 degrees around the tube or duct.

Guidelines by Category (Cont'd)

Category No.	Category Title	Guideline No.	Guideline
3.07	Environmental Control, Air Conditioning, and Pressurization	MC-14	Where multiple connectors are located in close proximity, ensure (1) a minimum hand tool arc of 120 degrees can be maintained, and (2) stagger fittings to ensure firm coupling interface/hand tool interface can be accomplished without inducing damage to adjacent lines.
		MP-01	Avoid the use of epoxies to mount parts on repairable modules because they make repair extremely difficult.
		MP-02	Use a unique identification (ID) resistor incorporated in each system module to verify that the proper module is mounted on ATE.
		MP-03	Design modules so that lengthy warm-up times, special coding and air purity levels, and similar constraints are not necessary.
		PERS-01	Group man-machine interfaces manifold-style to enable connect/disconnect in a single action.
		PERS-02	Include an integral, highly visible indicator in a man-machine interface connector to denote connector is seated and locked.
		PERS-03	Design interface connectors so that a distinct action is required by an individual to effect a disconnect. (Excludes airframe-to-ejection seat personnel interfaces.)
		PERS-04	Interfaces should contain an emergency release mechanism that can be activated by rescue personnel with a 95 percentile gloved hand.
		PERS-05	Design emergency interface release mechanisms to be clearly visible under all types of lighting situations.
		PERS-08	Design stowage and mounting provisions for portable air or oxygen containers to withstand 40G crash or impact loads.
		SABCH-02	All flush type structural screws should have identical head drives for the entire vehicle.
		SABCH-03	All non-flush type structural screws should have identical head drive recesses for the entire vehicle.
		SABCH-04	Special high strength bolts, such as twelve-point heads, should be fully justified from standpoint of the cost of ownership and effectiveness.
		SABCH-05	Structural design should avoid the reliance on blind fasteners unless fully supported by cost, weight, schedule, and effectiveness analysis.
		SEAT-01	Design personnel seats and padding materials, including the covers and fillers, so they are incapable of creating or emitting toxic fumes or dense smoke when subjected to fire.
		SI-03	Parts and assemblies of a given model product or of models of a product in the same series should be interchangeable or replaceable.
3.07.01	Oxygen Systems	A-03	All equipment bay and compartment structural flanges and stiffeners should be external to the compartment to maximize the volume available for equipment installation and arrangement.
		A-06	Hardpoints (structural attachment and load bearing areas) within a compartment to assist in equipment mounting or support should not be integral with the machined part. Hardpoints should be parasitic to enable quick repair in case of wear or damage in lieu of precise ream/bush repair typical of machined hardpoints.
		A-08	Plumbing penetrations into a compartment should not be on a vertical axis due to difficulty in making or breaking vertically-oriented connections. When compartment access is from the bottom, vertically-oriented connections can allow fluid to leak onto the maintainer. When access is from the top, such connections can allow foreign matter to enter the line. Use horizontal penetrations whenever possible.
		A-13	Two-sided or two-surfaced access should not be required for access to equipment interfaces and hardpoints. The term two-sided infers top/bottom, left/right, front/back, or combinations thereof.
		BIT-01	During design of the BIT, use worst-case stress analysis to ensure that any circuit failures induced by temperature extremes, tolerance build-up, power supply variations, and combinations thereof are identified.
		BIT-02	Ensure that BIT system thresholds are consistent with those across the system, subsystem, item, module, and piece-part levels to prevent excessive numbers of Cannot Duplicate (CND) and Retest OK (RTOK) events from occurring.
		BIT-03	The degree of BIT required or proposed should be based on the respective failure rates and the appropriate FMECA at all equipment indenture levels.

Guidelines by Category (Cont'd)

Category No.	Category Title	Guideline No.	Guideline
3.07.01	Oxygen Systems	BIT-04	Limit the amount of data that is recorded to a manageable size by: <ul style="list-style-type: none"> - Limiting the number of signals that are monitored - Limiting the maximum sampling rate - Reducing the time span over which data is accumulated - Restricting the type of data accumulated Incorporate testability design features as an integral part of equipment preliminary design process. Mission critical functions should be monitored by BIT. Use concurrent BIT to monitor system critical functions. The BIT should be mechanized so that when a piece of equipment is not installed in a subsystem or the product, a failure will not be indicated.
		BIT-05	
		BIT-06	
		BIT-09	
		BIT-20	
		BIT-26	Locate routinely used test points so they are accessible without removing or disassembling other equipment
		CBR-01	Orient all vehicle liquid servicing fittings to ensure fluids will not come in contact with protective garb during connect/disconnect activities.
		CREW-04	A void wiring, coax, and plumbing penetrations through the floor of crew cabs, operators' compartments, crew stations, cockpits, and passenger compartments. The geometric aspects of structural design and interfaces should not result in any natural bathtubs. Closed structural sections subject to condensation or fluid migration should contain drainage provisions.
		D&V-01	
		D&V-02	
		D&V-03	Crew cabs, operators' compartments, crew stations, cockpits, and passenger compartments should be subject to the same corrosion prevention measures as the exteriors of the vehicles. Low points, pockets, and related fluid collection points within should be provided with low point drains.
		MC-01	All clamps should contain torque-set or torque-limiting connections to prevent clamp or component failure due to over-torque. Clamp installation call outs should not depend on special tools to establish the required torque values.
		MC-02	Avoid the use of cotter pins, safety wire, safety clips, and similar devices to prevent maintenance-induced events leading to ground vehicle accidents or loss of air vehicles.
		MC-03	All tubing connections and interfaces should use rosan/dynatube (or equivalent) to (1) enable connect or disconnect with one hand, one tool, (2) eliminate the need to safety the connection, (3) provide a superior seal, and (4) negate need to reposition line(s) during component replacement.
		MC-04	No trombone type, flared tube type, or piloted line type interfaces should be used to avoid the need for removal or repositioning during equipment removal.
		MC-05	Avoid potential foreign object traps during manufacturing or operational maintenance by eliminating vertical penetrations of plumbing/fittings into tanks, compartments, or cells
		MC-06	Locate, position, orient all plumbing and duct electrical connectors to prevent the need for sequential installation or removal.
		MC-09	All plumbing connections and fittings used for fuel systems should contain integral bonding features to eliminate the need for bonding clamps or jumper cables.
		MC-10	In rare instances where a plumbing run contains complex form or geometry that would require removal of other plumbing or equipment for access, in-line connectors should be incorporated to maintain the integrity of other plumbing or equipment.
		MC-11	No subsystem plumbing, equipment, or wiring should use a tank, cell, or compartment containing liquids as a means for routing or penetration simplicity during manufacture.
		MC-12	All plumbing and connectors containing liquids should be meniscus-free.
		MC-13	In instances where plumbing or connector interfaces cannot or are not keyed for a specific orientation, all identification, markings, cautions, and directions should be placed 360 degrees around the tube or duct.
		MC-14	Where multiple connectors are located in close proximity, ensure (1) a minimum hand tool arc of 120 degrees can be maintained, and (2) stagger fittings to ensure firm coupling interface/hand tool interface can be accomplished without inducing damage to adjacent lines.
		MP-01	Avoid the use epoxies to mount parts on repairable modules because they make repair extremely difficult.

MIL-HDBK-470A

APPENDIX C

Guidelines by Category (Cont'd)

Category No.	Category Title	Guideline No.	Guideline
3.07.01	Oxygen Systems	MP-02	Use a unique identification (ID) resistor incorporated in each system module to verify that the proper module is mounted on ATE.
		MP-03	Design modules so that lengthy warm-up times, special coding and air purity levels, and similar constraints are not necessary.
		OXY-01	System should contain automatic BIT for warning indicators to eliminate dedicated test switches and/or test requirements.
		OXY-02	Provide sensors to denote occurrence of On-Board Oxygen Generating Systems (OBOGS) bleed air over temperature.
		OXY-03	Provide condition sensors for oxygen concentrators to eliminate periodic and/or forced replacement.
		OXY-04	OBOGS should be given preference over liquid oxygen systems.
		OXY-05	Locate liquid oxygen (LOX) containers in a sealed, dedicated compartment to eliminate need for frequent visual inspections.
		OXY-06	Liquid oxygen container design and integration should contain appropriate sensors to detect and monitor air filter brazement.
		OXY-07	Locate liquid oxygen containers to ensure simultaneous replacement with other turnaround activities.
		OXY-08	LOX containers should contain rear mounted, automatic interfaces.
		OXY-09	Special or common hand tools should not be required to remove or replace LOX containers.
		OXY-10	Effective leak detection sensors should be integral to the system.
		OXY-11	System operational and service condition status should be capable of being downlinked to centralized maintenance facilities.
		OXY-12	LOX compartments should be sealed from adjacent compartments and should contain dedicated overboard drains.
		P-06	Access door and panel devices used to support door in opened position should meet the following criteria: <ul style="list-style-type: none"> - for airborne vehicles, design for 60 knot gust loads (or equivalent jet blast loads) - for ground vehicles, design for 50 mph gust loads
		P-07	Hinged access doors and panels capable of remaining in the opened position should not have sharp edges or corners.
		P-08	Removable access door and panel fasteners should be of identical grip length and diameter.
		P-09	Acceptable door and panel hold-open devices include over-center sheet metal spring, over-center spring link, spring cartridge, support strut, and pinned goose neck hinge.
		P-10	Access doors and panels requiring non-captive fasteners should not be located forward of air inlet ducts or high-energy rotating components (e.g., prop fans, engine cooling fans, etc.).
		P-11	Access doors and panels should be interchangeable as justified by operation and support costs or life cycle costs.
		PERS-01	Group man-machine interfaces manifold-style to enable connect/disconnect in a single action.
		PERS-02	Include an integral, highly visible indicator in a man-machine interface connector to denote connector is seated and locked.
		PERS-03	Design interface connectors so that a distinct action is required by an individual to effect a disconnect. (Excludes airframe-to-ejection seat personnel interfaces.)
		PERS-04	Interfaces should contain an emergency release mechanism that can be activated by rescue personnel with a 95 percentile gloved hand.
		PERS-05	Design emergency interface release mechanisms to be clearly visible under all types of lighting situations.
		PERS-08	Design stowage and mounting provisions for portable air or oxygen containers to withstand 40G crash or impact loads.
		SABCH-02	All flush type structural screws should have identical head drives for the entire vehicle.
		SABCH-03	All non-flush type structural screws should have identical head drive recesses for the entire vehicle.
		SABCH-04	Special high strength bolts, such as twelve-point heads, should be fully justified from standpoint of the cost of ownership and effectiveness.
		SABCH-05	Structural design should avoid the reliance on blind fasteners unless fully supported by cost, weight, schedule, and effectiveness analysis.

Guidelines by Category (Cont'd)

Category No.	Category Title	Guideline No.	Guideline
3.07.01	Oxygen Systems	SI-03	Parts and assemblies of a given model product or of models of a product in the same series should be interchangeable or replaceable.
3.08	Armament and Explosives	A-04	Use stiffening beads in lieu of flanges to the maximum extent to enhance compartment volume and simplify repairs. Stiffening beads should have the convex surface toward the compartment to eliminate fluid traps.
		A-05	Keep all machined compartment frames, webs, and closure panels to a constant thickness (e.g., not stepped or tapered) to ease simplicity of fluid or electrical penetrations and ease and simplicity of structural repair.
		A-06	Hardpoints (structural attachment and load bearing areas) within a compartment to assist in equipment mounting or support should not be integral with the machined part. Hardpoints should be parasitic to enable quick repair in case of wear or damage in lieu of precise ream/bush repair typical of machined hardpoints.
		A-07	Paint equipment bay and compartment interiors a high gloss white to maximize lighting reflectivity, visibility, and rapid leak detection capability.
		A-10	Provide a sufficient number of compartment fluid drains to ensure fluid drainage for varying aircraft static attitudes and varying terrain slopes for ground vehicles.
		A-11	Locate compartment electrical penetrations close to the access opening for ease of sight, probing, repair, and to eliminate fluid soaking, wicking, or contamination.
		A-12	Locate compartment electrical penetrations far enough from the access opening to prevent damage resulting from improper (over-length) panel fasteners.
		A-13	Two-sided or two-surfaced access should not be required for access to equipment interfaces and hardpoints. The term two-sided infers top/bottom, left/right, front/back, or combinations thereof.
		A-14	Do not locate nutplates or gang channels in inaccessible areas that would require extensive disassembly or equipment removal to gain access.
		A-18	Use transparent windows, quick-opening covers, or openings without any cover to permit quick visual inspections where needed.
		ARM-01	For an aircraft, the fuselage lower shear moldline should be no less than 38" above the ground when external weapons only will be carried on the fuselage.
		ARM-02	For an aircraft, the fuselage lower shear moldline should be no less than 50" above the ground when internal weapons will be carried in the fuselage and weapon bay door widths exceed 22".
		ARM-03	Locate fuselage weapon bays a minimum of 18" from the nose landing gear and main landing gear of an aircraft.
		ARM-04	No single weapon/store mounted on a transporter should intrude into the service/turnaround envelope of another station.
		ARM-05	All servicing and turnaround functions (including movement envelopes) should be outside the gun firing envelope.
		ARM-06	The relationship of the nose landing gear to the main landing gear should not restrict the positioning of weapon transporters under the fuselage of an aircraft.
		ARM-07	The design of weapon and store ejectors and launchers should not require scheduled servicing, maintenance, or inspection requirements prior to upload of the weapon or store.
		ARM-08	Weapon and store ejectors containing arming solenoids should ensure the solenoids can be rapidly replaced while installed.
		ARM-09	Weapon and store ejectors containing adjustable pitch control devices should ensure devices are easily accessible and adjustments are Murphy-free.
		ARM-10	Weapon and store stations should be located to ensure vehicle ballasting will not be required under any combination of weapon/store configurations.
		BIT-05	Incorporate testability design features as an integral part of equipment preliminary design process.
		BIT-06	Mission critical functions should be monitored by BIT.
		BIT-09	Use concurrent BIT to monitor system critical functions.
		BIT-20	The BIT should be mechanized so that when a piece of equipment is not installed in a subsystem or the product, a failure will not be indicated.
		BIT-26	Locate routinely used test points so they are accessible without removing or disassembling other equipment

Guidelines by Category (Cont'd)

Category No.	Category Title	Guideline No.	Guideline
3.08	Armament and Explosives		
		D&V-01	The geometric aspects of structural design and interfaces should not result in any natural bathtubs.
		D&V-02	Closed structural sections subject to condensation or fluid migration should contain drainage provisions.
		D&V-03	Crew cabs, operators' compartments, crew stations, cockpits, and passenger compartments should be subject to the same corrosion prevention measures as the exteriors of the vehicles. Low points, pockets, and related fluid collection points within should be provided with low point drains.
		FUEL-01	Locate fuel vent and dump masts to ensure exiting fuel will be clear of servicing, loading, arming and safing areas for all types of ground and airborne vehicles.
		MC-02	Avoid the use of cotter pins, safety wire, safety clips, and similar devices to prevent maintenance-induced events leading to ground vehicle accidents or loss of air vehicles.
		MC-06	Locate, position, orient all plumbing and duct electrical connectors to prevent the need for sequential installation or removal.
		MC-09	All plumbing connections and fittings used for fuel systems should contain integral bonding features to eliminate the need for bonding clamps or jumper cables.
		MC-10	In rare instances where a plumbing run contains complex form or geometry that would require removal of other plumbing or equipment for access, in-line connectors should be incorporated to maintain the integrity of other plumbing or equipment.
		MC-12	All plumbing and connectors containing liquids should be meniscus-free.
		MC-13	In instances where plumbing or connector interfaces cannot or are not keyed for a specific orientation, all identification, markings, cautions, and directions should be placed 360 degrees around the tube or duct.
		MC-14	Where multiple connectors are located in close proximity, ensure (1) a minimum hand tool arc of 120 degrees can be maintained, and (2) stagger fittings to ensure firm coupling interface/hand tool interface can be accomplished without inducing damage to adjacent lines.
		MP-01	Avoid the use of epoxies to mount parts on repairable modules because they make repair extremely difficult.
		MP-02	Use a unique identification (ID) resistor incorporated in each system module to verify that the proper module is mounted on ATE.
		MP-03	Design modules so that lengthy warm-up times, special coding and air purity levels, and similar constraints are not necessary.
		PYRO-01	Provide the "safe/arm" status to the pilot, crew, or gunner in the cockpit, crew station, or operator station as appropriate.
		PYRO-02	Provide the "safe/arm" status as an external cue discernible from a distance of 10-20 feet.
		PYRO-06	"Safe/arm" mechanism design should be free from FOD potential.
		PYRO-07	Manual "safe/arm" mechanisms should be well-clear of inlet ducts, propellers, rotors, and similar rotating components.
		PYRO-08	Manual "safe/arm" mechanisms should be well-clear of engine exhausts, fuel/toxic vents, fluid drains, control surface deflection envelopes, and rescue path envelopes.
		PYRO-09	Provide positive, Murphy-proof locking detents for both the "safe" and "arm" positions of mechanical mechanisms.
		PYRO-11	Design electrical/electronic "safe/arm" systems to eliminate the need for mechanical type system interrupt devices.
		PYRO-12	Design of weapons, flare/chaff packages, and airborne pyrotechnic containers should follow the "wooden round" design concept to eliminate scheduled tests, checks, and inspections throughout its intended life cycle.
		PYRO-13	Container design for shipping, handling, and storing weapons, flares, chaff, and similar devices should not require special atmospheres.
		PYRO-14	Design weapon drop and fire/release circuits with frequency-coded firing systems or similar concepts to ensure stray energy tests and checks will not be required and that stray energy will not impose a safety hazard or problem.
		PYRO-15	Pylon-to-weapon and pylon-to-air vehicle electrical interfaces should contain built-in test/fault location capabilities.
		PYRO-21	Weapon bays should contain internal lighting controlled by a separate switch that is only functional when doors are open
		PYRO-22	A "rounds remaining" status should be available at the gun loading interface, maintenance panel, or cockpit/crew station/operator station.
		PYRO-23	Crew size for full ammo load should not exceed two persons.

Guidelines by Category (Cont'd)

Category No.	Category Title	Guideline No.	Guideline
3.08	Armament and Explosives		
		PYRO-24	Ammo loader interface should not be less than 30" nor more than 50" above the ground to ensure loading can be accomplished by a wide range of percentiles wearing chemical or biological protective gear.
		PYRO-25	Gun loading and servicing should be possible concurrently with all other weapon loading and servicing activities to minimize the elapsed downtime.
		PYRO-26	Do not locate ammunition loader interfaces close to inlets, exhausts, fuel dumps and drains, antennas, sensors, lights, or hazardous protrusions.
		PYRO-27	Incorporate integral hoisting provisions at each weapon/store station to enable direct lift from the container or carrier to the attachment hardpoints.
		PYRO-28	Automatic locking of the retention hooks should be accomplished for each respective weapon and store.
		PYRO-29	Provide quick mechanical over-travel (no power) for weapon bay doors to maximize the weapon/store loading envelope.
		PYRO-30	Ensure weapon bay door arc (both normal and over-travel) does not block or intrude into adjacent service points or envelopes.
		PYRO-32	Provide sufficient longitudinal clearance between weapon bays to enable simultaneous loading of two bays.
		PYRO-33	Provide sufficient lateral clearance between weapon bays to enable simultaneous loading of two bays.
		PYRO-34	Weapon bay door seals should be bonded or attached to door structure to minimize induced seal damage during weapon or store loading.
		PYRO-35	Suspension system should permit any single weapon or store to be loaded by a two man crew.
		PYRO-36	Suspension system design and spacing should enable any combination of eight weapons to be loaded by two two-man crews within the refueling time of the vehicle (excludes nuclear weapons).
		PYRO-37	Internal weapon suspension arrangements should preclude sequential weapon loading.
		PYRO-38	Any single pylon or built-up pylon/weapon package should have the capability for rapid reconfiguration.
		PYRO-39	Weapon bay ejectors and launchers should have the capability for total interchangeability and reconfigurability.
		PYRO-40	All weapon and store loading functions should be within the percentile range of 5% female to 95% male standing at ground level.
		PYRO-41	Weapon or store handling and transportation equipment should be compatible with rough terrain and capable of 25 mph towing speeds minimum.
		PYRO-42	In weapons carriage design and integration, avoid dependence of on-board high pressure nitrogen.
		PYRO-43	Launcher or ejector design/interface should not require a dual function of carrying airframe structural loads.
		PYRO-44	Launcher and ejector design should incorporate automatic sway bracing.
		PYRO-45	Missile ejectors should be provided with repeatable missile motor fire wires to simplify loading and reduce elapsed time.
		PYRO-46	Design pylons, launchers, and ejector racks so that weapon loading, servicing, and reconfigurations can be accomplished using standard hand tools.
		PYRO-47	Installation design of ejectors, launchers, racks, and associated hardware interfaces should avoid reliance on torque wrenches.
		SE-04	Gun port covers or plugs should be lightweight, 100% effective, and easy to install or store.
		SI-03	Parts and assemblies of a given model product or of models of a product in the same series should be interchangeable or replaceable.
		WBAY-11	Gap seal should match pylon and wing/fuselage surface impedance.
		WBAY-12	Pylon-to-store/weapon gap seal should permit visual and physical access during loading for all interfaces between bomb rack-to-store, bomb rack-to-launcher, and launcher-to-store.
		WBAY-13	Pylon-to-store/weapon gap seal should not interfere with automatic sway brace function.
		WBAY-14	Pylon-to-store/weapon gap seal should permit physical access to lanyards.
		WBAY-15	Gap seals should not hinder pilot or ground crew preflight inspection.
		WBAY-16	Gap seals should not degrade loading while wearing arctic or chemical, biological, or radiation protective clothing.

Guidelines by Category (Cont'd)

Category No.	Category Title	Guideline No.	Guideline
3.08	Armament and Explosives	WBAY-17	Special coatings or conductive paints on pylons, launchers, racks, launchers, tanks, pods, etc. should have the durability to withstand contact with support stands/cradles during storage.
3.08.01	Armor	WBAY-18	The proximity of the gun firing barrel to structure should be such that structural furrows or channels are not required for projectile clearances during firing.
		CREW-02	Armor protection integrated with the vehicle structure should be given preference over parasitic armor.
		MC-02	Avoid the use of cotter pins, safety wire, safety clips, and similar devices to prevent maintenance-induced events leading to ground vehicle accidents or loss of air vehicles.
		PYRO-36	Suspension system design and spacing should enable any combination of eight weapons to be loaded by two two-man crews within the refueling time of the vehicle (excludes nuclear weapons).
		PYRO-37	Internal weapon suspension arrangements should preclude sequential weapon loading.
		PYRO-38	Any single pylon or built-up pylon/weapon package should have the capability for rapid reconfiguration.
		PYRO-39	Weapon bay ejectors and launchers should have the capability for total interchangeability and reconfigurability.
		PYRO-40	All weapon and store loading functions should be within the percentile range of 5% female to 95% male standing at ground level.
		SI-03	Parts and assemblies of a given model product or of models of a product in the same series should be interchangeable or replaceable.
3.08.02	Weapons, Guns, Flares, Chaff, and Cannon	A-06	Hardpoints (structural attachment and load bearing areas) within a compartment to assist in equipment mounting or support should not be integral with the machined part. Hardpoints should be parasitic to enable quick repair in case of wear or damage in lieu of precise ream/bush repair typical of machined hardpoints.
		A-09	Any heat or temperature sensitive structure within a compartment should contain heat-sensitive tape or appropriate heat sensor for easy indication of over-temperature excursions.
		A-15	Locate tie-down attachment points such that tie-down chains, straps, or cables do not prevent or restrict normal servicing, weapon loading, or safe/arm functions.
		ARM-01	For an aircraft, the fuselage lower shear moldline should be no less than 38" above the ground when external weapons only will be carried on the fuselage.
		ARM-02	For an aircraft, the fuselage lower shear moldline should be no less than 50" above the ground when internal weapons will be carried in the fuselage and weapon bay door widths exceed 22".
		ARM-03	Locate fuselage weapon bays a minimum of 18" from the nose landing gear and main landing gear of an aircraft.
		ARM-04	No single weapon/store mounted on a transporter should intrude into the service/turnaround envelope of another station.
		ARM-05	All servicing and turnaround functions (including movement envelopes) should be outside the gun firing envelope.
		ARM-06	The relationship of the nose landing gear to the main landing gear should not restrict the positioning of weapon transporters under the fuselage of an aircraft.
		ARM-07	The design of weapon and store ejectors and launchers should not require scheduled servicing, maintenance, or inspection requirements prior to upload of the weapon or store.
		ARM-08	Weapon and store ejectors containing arming solenoids should ensure the solenoids can be rapidly replaced while installed.
		ARM-09	Weapon and store ejectors containing adjustable pitch control devices should ensure devices are easily accessible and adjustments are Murphy-free.
		ARM-10	Weapon and store stations should be located to ensure vehicle ballasting will not be required under any combination of weapon/store configurations.
BIT-01	During design of the BIT, use worst-case stress analysis to ensure that any circuit failures induced by temperature extremes, tolerance build-up, power supply variations, and combinations thereof are identified.		
BIT-02	Ensure that BIT system thresholds are consistent with those across the system, subsystem, item, module, and piece-part levels to prevent excessive numbers of Cannot Duplicate (CND) and Retest OK (RTOK) events from occurring.		
BIT-03	The degree of BIT required or proposed should be based on the respective failure rates and the appropriate FMECA at all equipment indenture levels.		

Guidelines by Category (Cont'd)

Category No.	Category Title	Guideline No.	Guideline
3.08.02	Weapons, Guns, Flares, Chaff, and Cannon	BIT-04	Limit the amount of data that is recorded to a manageable size by: <ul style="list-style-type: none"> - Limiting the number of signals that are monitored - Limiting the maximum sampling rate - Reducing the time span over which data is accumulated - Restricting the type of data accumulated Incorporate testability design features as an integral part of equipment preliminary design process. Mission critical functions should be monitored by BIT. Use concurrent BIT to monitor system critical functions. The BIT should be mechanized so that when a piece of equipment is not installed in a subsystem or the product, a failure will not be indicated. Locate routinely used test points so they are accessible without removing or disassembling other equipment Orient all vehicle liquid servicing fittings to ensure fluids will not come in contact with protective garb during connect/disconnect activities. In rare cases where armor is parasitic, armor should be interchangeable and easily installed. The geometric aspects of structural design and interfaces should not result in any natural bathtubs. Closed structural sections subject to condensation or fluid migration should contain drainage provisions. Crew cabs, operators' compartments, crew stations, cockpits, and passenger compartments should be subject to the same corrosion prevention measures as the exteriors of the vehicles. Low points, pockets, and related fluid collection points within should be provided with low point drains. Materials, treatments, coatings, finishes should be compatible with all anti-ice and de-ice fluids, chemical and biological decontamination fluids, washing and cleaning fluids, and all vehicle subsystem fluids. There should be no top coat or treatment deterioration throughout the standard temperature and humidity spectrum. For airborne vehicles, the finishes should be durable against rain, hail, and dynamic erosion throughout the flight envelope. For airborne and ground vehicles, the finishes should be durable against sand erosion throughout all surface wind speeds experienced in arid or desert geographical locations. For ground vehicles, the finishes should be compatible with and durable against all rain, hail, sleet, snow, and ice conditions experienced in all intended operational environments. Locate fuel vent and dump masts to ensure exiting fuel will be clear of servicing, loading, arming and safing areas for all types of ground and airborne vehicles. All clamps should contain torque-set or torque-limiting connections to prevent clamp or component failure due to over-torque. Clamp installation call outs should not depend on special tools to establish the required torque values. Avoid the use of cotter pins, safety wire, safety clips, and similar devices to prevent maintenance-induced events leading to ground vehicle accidents or loss of air vehicles. All tubing connections and interfaces should use rosan/dynatube (or equivalent) to (1) enable connect or disconnect with one hand, one tool, (2) eliminate the need to safety the connection, (3) provide a superior seal, and (4) negate need to reposition line(s) during component replacement. No trombone type, flared tube type, or piloted line type interfaces should be used to avoid the need for removal or repositioning during equipment removal. Locate, position, orient all plumbing and duct electrical connectors to prevent the need for sequential installation or removal. All plumbing connections and fittings used for fuel systems should contain integral bonding features to eliminate the need for bonding clamps or jumper cables. In rare instances where a plumbing run contains complex form or geometry that would require removal of other plumbing or equipment for access, in-line connectors should be incorporated to maintain the integrity of other plumbing or equipment. All plumbing and connectors containing liquids should be meniscus-free.
		BIT-05	
		BIT-06	
		BIT-09	
		BIT-20	
		BIT-26	
		CBR-01	
		CREW-03	
		D&V-01	
		D&V-02	
		D&V-03	
		ENV-01	
		ENV-02	
		ENV-03	
		ENV-04	
		ENV-06	
		FUEL-01	
		MC-01	
		MC-02	
		MC-03	
		MC-04	
		MC-06	
		MC-09	
		MC-10	
		MC-12	

MIL-HDBK-470A

APPENDIX C

Guidelines by Category (Cont'd)

Category No.	Category Title	Guideline No.	Guideline
3.08.02	Weapons, Guns, Flares, Chaff, and Cannon	MC-13	In instances where plumbing or connector interfaces cannot or are not keyed for a specific orientation, all identification, markings, cautions, and directions should be placed 360 degrees around the tube or duct.
		MC-14	Where multiple connectors are located in close proximity, ensure (1) a minimum hand tool arc of 120 degrees can be maintained, and (2) stagger fittings to ensure firm coupling interface/hand tool interface can be accomplished without inducing damage to adjacent lines.
		MP-01	Avoid the use of epoxies to mount parts on repairable modules because they make repair extremely difficult.
		MP-02	Use a unique identification (ID) resistor incorporated in each system module to verify that the proper module is mounted on ATE.
		MP-03	Design modules so that lengthy warm-up times, special coding and air purity levels, and similar constraints are not necessary.
		P-06	Access door and panel devices used to support door in opened position should meet the following criteria: - for airborne vehicles, design for 60 knot gust loads (or equivalent jet blast loads) - for ground vehicles, design for 50 mph gust loads
		P-07	Hinged access doors and panels capable of remaining in the opened position should not have sharp edges or corners.
		P-08	Removable access door and panel fasteners should be of identical grip length and diameter.
		P-09	Acceptable door and panel hold-open devices include over-center sheet metal spring, over-center spring link, spring cartridge, support strut, and pinned goose neck hinge.
		P-10	Access doors and panels requiring non-captive fasteners should not be located forward of air inlet ducts or high-energy rotating components (e.g., prop fans, engine cooling fans, etc.).
		P-11	Access doors and panels should be interchangeable as justified by operation and support costs or life cycle costs.
		PYRO-01	Provide the "safe/arm" status to the pilot, crew, or gunner in the cockpit, crew station, or operator station as appropriate.
		PYRO-02	Provide the "safe/arm" status as an external cue discernible from a distance of 10-20 feet.
		PYRO-06	"Safe/arm" mechanism design should be free from FOD potential.
		PYRO-07	Manual "safe/arm" mechanisms should be well-clear of inlet ducts, propellers, rotors, and similar rotating components.
		PYRO-08	Manual "safe/arm" mechanisms should be well-clear of engine exhausts, fuel/toxic vents, fluid drains, control surface deflection envelopes, and rescue path envelopes.
		PYRO-09	Provide positive, Murphy-proof locking detents for both the "safe" and "arm" positions of mechanical mechanisms.
		PYRO-16	Do not use cartridge actuated devices (CADs) for store or weapon ejection or for pylon jettison due to inherent ground safety hazards, stray energy hazards, and scheduled cleaning requirements.
		PYRO-17	In rare instances where use of CADs may be required, a positive indication to denote "cartridge installed" should be provided.
		PYRO-18	Mechanical "safe/arm" mechanism design should enable activation by a 95 percentile male wearing arctic mittens.
		PYRO-19	Locate built-in grounding receptacles clear of weapon approach and loading envelopes.
		PYRO-20	Weapon bay doors, when opened, should not block or restrict access to other servicing points.
		PYRO-21	Weapon bays should contain internal lighting controlled by a separate switch that is only functional when doors are open
		PYRO-22	A "rounds remaining" status should be available at the gun loading interface, maintenance panel, or cockpit/crew station/operator station.
		PYRO-23	Crew size for full ammo load should not exceed two persons.
		PYRO-24	Ammo loader interface should not be less than 30" nor more than 50" above the ground to ensure loading can be accomplished by a wide range of percentiles wearing chemical or biological protective gear.
		PYRO-25	Gun loading and servicing should be possible concurrently with all other weapon loading and servicing activities to minimize the elapsed downtime.
		PYRO-26	Do not locate ammunition loader interfaces close to inlets, exhausts, fuel dumps and drains, antennas, sensors, lights, or hazardous protrusions.
		PYRO-27	Incorporate integral hoisting provisions at each weapon/store station to enable direct lift from the container or carrier to the attachment hardpoints.

MIL-HDBK-470A

APPENDIX C

Guidelines by Category (Cont'd)

Category No.	Category Title	Guideline No.	Guideline
3.08.02	Weapons, Guns, Flares, Chaff, and Cannon	PYRO-28	Automatic locking of the retention hooks should be accomplished for each respective weapon and store.
		PYRO-29	Provide quick mechanical over-travel (no power) for weapon bay doors to maximize the weapon/store loading envelope.
		PYRO-30	Ensure weapon bay door arc (both normal and over-travel) does not block or intrude into adjacent service points or envelopes.
		PYRO-32	Provide sufficient longitudinal clearance between weapon bays to enable simultaneous loading of two bays.
		PYRO-33	Provide sufficient lateral clearance between weapon bays to enable simultaneous loading of two bays.
		PYRO-34	Weapon bay door seals should be bonded or attached to door structure to minimize induced seal damage during weapon or store loading.
		PYRO-35	Suspension system should permit any single weapon or store to be loaded by a two man crew.
		PYRO-36	Suspension system design and spacing should enable any combination of eight weapons to be loaded by two two-man crews within the refueling time of the vehicle (excludes nuclear weapons).
		PYRO-37	Internal weapon suspension arrangements should preclude sequential weapon loading.
		PYRO-38	Any single pylon or built-up pylon/weapon package should have the capability for rapid reconfiguration.
		PYRO-39	Weapon bay ejectors and launchers should have the capability for total interchangeability and reconfigurability.
		PYRO-40	All weapon and store loading functions should be within the percentile range of 5% female to 95% male standing at ground level.
		PYRO-41	Weapon or store handling and transportation equipment should be compatible with rough terrain and capable of 25 mph towing speeds minimum.
		PYRO-42	In weapons carriage design and integration, avoid dependence of on-board high pressure nitrogen.
		PYRO-43	Launcher or ejector design/interface should not require a dual function of carrying airframe structural loads.
		PYRO-44	Launcher and ejector design should incorporate automatic sway bracing.
		PYRO-45	Missile ejectors should be provided with repeatable missile motor fire wires to simplify loading and reduce elapsed time.
		PYRO-46	Design pylons, launchers, and ejector racks so that weapon loading, servicing, and reconfigurations can be accomplished using standard hand tools.
		PYRO-47	Installation design of ejectors, launchers, racks, and associated hardware interfaces should avoid reliance on torque wrenches.
		SABCH-02	All flush type structural screws should have identical head drives for the entire vehicle.
		SABCH-03	All non-flush type structural screws should have identical head drive recesses for the entire vehicle.
		SABCH-04	Special high strength bolts, such as twelve-point heads, should be fully justified from standpoint of the cost of ownership and effectiveness.
		SABCH-05	Structural design should avoid the reliance on blind fasteners unless fully supported by cost, weight, schedule, and effectiveness analysis.
		SAFE-12	Internal weapon bay doors should contain integral safety locking features for use during maintenance and weapon loading and downloading.
		SAFE-13	It should not be possible to unsafe a weapon bay door integral lock when a door closed signal is present.
		SE-04	Gun port covers or plugs should be lightweight, 100% effective, and easy to install or store.
		SI-03	Parts and assemblies of a given model product or of models of a product in the same series should be interchangeable or replaceable.
		WBAY-11	Gap seal should match pylon and wing/fuselage surface impedance.
		WBAY-12	Pylon-to-store/weapon gap seal should permit visual and physical access during loading for all interfaces between bomb rack-to-store, bomb rack-to-launcher, and launcher-to-store.
		WBAY-13	Pylon-to-store/weapon gap seal should not interfere with automatic sway brace function.
		WBAY-14	Pylon-to-store/weapon gap seal should permit physical access to lanyards.
		WBAY-15	Gap seals should not hinder pilot or ground crew preflight inspection.

Guidelines by Category (Cont'd)

Category No.	Category Title	Guideline No.	Guideline
3.08.02	Weapons, Guns, Flares, Chaff, and Cannon	WBAY-16	Gap seals should not degrade loading while wearing arctic or chemical, biological, or radiation protective clothing.
		WBAY-17	Special coatings or conductive paints on pylons, launchers, racks, launchers, tanks, pods, etc. should have the durability to withstand contact with support stands/cradles during storage.
		WBAY-18	The proximity of the gun firing barrel to structure should be such that structural furrows or channels are not required for projectile clearances during firing.
		WBAY-19	Frangible gun ports should take preference over mechanized gun port doors.
		WBAY-20	Gun plugs required solely to maintain a given signature level should be capable of on-board stowage for use only when a threat requires their presence.
		WBAY-21	Coatings and finishes in the area of gun barrels should be durable to withstand the effect of exiting projectile shockwaves.
		WBAY-22	The proximity of the gun blast deflector to structure should not require reliance on high-temperature paints or coatings to protect the structure.
3.08.03	Cartridge Actuated Devices, Shaped Charges, Detonating Cord, and Pyrotechnic Devices	A-09	Any heat or temperature sensitive structure within a compartment should contain heat-sensitive tape or appropriate heat sensor for easy indication of over-temperature excursions.
		ARM-08	Weapon and store ejectors containing arming solenoids should ensure the solenoids can be rapidly replaced while installed.
		BIT-05	Incorporate testability design features as an integral part of equipment preliminary design process.
		BIT-06	Mission critical functions should be monitored by BIT.
		BIT-09	Use concurrent BIT to monitor system critical functions.
		BIT-20	The BIT should be mechanized so that when a piece of equipment is not installed in a subsystem or the product, a failure will not be indicated.
		BIT-26	Locate routinely used test points so they are accessible without removing or disassembling other equipment
		CONT-01	Control rods should use Boyd or impedance type bolts (or equivalent) to eliminate the need for cotter pins or safety wire.
		CONT-02	Do not use metal control cables for vehicles that will operate in salt water or salt air environments.
		CONT-03	Use control rods rather than control cables for non-complex applications and non-complex routing within the vehicle.
		CONT-04	Use control cables rather than control rods for most complex applications.
		CONT-05	Route cables so that 100 percent of a cable will be viewable for inspection.
		CONT-06	Design all pulleys and brackets associated with cable installations so they are accessible by a 75 percentile male hand.
		FUEL-01	Locate fuel vent and dump masts to ensure exiting fuel will be clear of servicing, loading, arming and safing areas for all types of ground and airborne vehicles.
		MC-01	All clamps should contain torque-set or torque-limiting connections to prevent clamp or component failure due to over-torque. Clamp installation call outs should not depend on special tools to establish the required torque values.
		MC-02	Avoid the use of cotter pins, safety wire, safety clips, and similar devices to prevent maintenance-induced events leading to ground vehicle accidents or loss of air vehicles.
		MC-03	All tubing connections and interfaces should use rosan/dynatube (or equivalent) to (1) enable connect or disconnect with one hand, one tool, (2) eliminate the need to safety the connection, (3) provide a superior seal, and (4) negate need to reposition line(s) during component replacement
		MC-04	No trombone type, flared tube type, or piloted line type interfaces should be used to avoid the need for removal or repositioning during equipment removal.
		MC-06	Locate, position, orient all plumbing and duct electrical connectors to prevent the need for sequential installation or removal.
		MC-09	All plumbing connections and fittings used for fuel systems should contain integral bonding features to eliminate the need for bonding clamps or jumper cables.
		MC-10	In rare instances where a plumbing run contains complex form or geometry that would require removal of other plumbing or equipment for access, in-line connectors should be incorporated to maintain the integrity of other plumbing or equipment.

Guidelines by Category (Cont'd)

Category No.	Category Title	Guideline No.	Guideline
3.08.03	Cartridge Actuated Devices, Shaped Charges, Detonating Cord, and Pyrotechnic Devices	MC-12	All plumbing and connectors containing liquids should be meniscus-free.
		MC-13	In instances where plumbing or connector interfaces cannot or are not keyed for a specific orientation, all identification, markings, cautions, and directions should be placed 360 degrees around the tube or duct.
		MC-14	Where multiple connectors are located in close proximity, ensure (1) a minimum hand tool arc of 120 degrees can be maintained, and (2) stagger fittings to ensure firm coupling interface/hand tool interface can be accomplished without inducing damage to adjacent lines.
		P-06	Access door and panel devices used to support door in opened position should meet the following criteria: - for airborne vehicles, design for 60 knot gust loads (or equivalent jet blast loads) - for ground vehicles, design for 50 mph gust loads
		P-07	Hinged access doors and panels capable of remaining in the opened position should not have sharp edges or corners.
		P-08	Removable access door and panel fasteners should be of identical grip length and diameter.
		P-09	Acceptable door and panel hold-open devices include over-center sheet metal spring, over-center spring link, spring cartridge, support strut, and pinned goose neck hinge.
		P-10	Access doors and panels requiring non-captive fasteners should not be located forward of air inlet ducts or high-energy rotating components (e.g., prop fans, engine cooling fans, etc.).
		P-11	Access doors and panels should be interchangeable as justified by operation and support costs or life cycle costs.
		PYRO-01	Provide the "safe/arm" status to the pilot, crew, or gunner in the cockpit, crew station, or operator station as appropriate.
		PYRO-02	Provide the "safe/arm" status as an external cue discernible from a distance of 10-20 feet.
		PYRO-06	"Safe/arm" mechanism design should be free from FOD potential.
		PYRO-07	Manual "safe/arm" mechanisms should be well-clear of inlet ducts, propellers, rotors, and similar rotating components.
		PYRO-08	Manual "safe/arm" mechanisms should be well-clear of engine exhausts, fuel/toxic vents, fluid drains, control surface deflection envelopes, and rescue path envelopes.
		PYRO-09	Provide positive, Murphy-proof locking detents for both the "safe" and "arm" positions of mechanical mechanisms.
		PYRO-11	Design electrical/electronic "safe/arm" systems to eliminate the need for mechanical type system interrupt devices.
		PYRO-12	Design of weapons, flare/chaff packages, and airborne pyrotechnic containers should follow the "wooden round" design concept to eliminate scheduled tests, checks, and inspections throughout its intended life cycle.
		PYRO-13	Container design for shipping, handling, and storing weapons, flares, chaff, and similar devices should not require special atmospheres.
		PYRO-14	Design weapon drop and fire/release circuits with frequency-coded firing systems or similar concepts to ensure stray energy tests and checks will not be required and that stray energy will not impose a safety hazard or problem.
		PYRO-15	Pylon-to-weapon and pylon-to-air vehicle electrical interfaces should contain built-in test/fault location capabilities.
		PYRO-21	Weapon bays should contain internal lighting controlled by a separate switch that is only functional when doors are open
		PYRO-22	A "rounds remaining" status should be available at the gun loading interface, maintenance panel, or cockpit/crew station/operator station.
		PYRO-23	Crew size for full ammo load should not exceed two persons.
		PYRO-24	Ammo loader interface should not be less than 30" nor more than 50" above the ground to ensure loading can be accomplished by a wide range of percentiles wearing chemical or biological protective gear.
		PYRO-25	Gun loading and servicing should be possible concurrently with all other weapon loading and servicing activities to minimize the elapsed downtime.
		PYRO-26	Do not locate ammunition loader interfaces close to inlets, exhausts, fuel dumps and drains, antennas, sensors, lights, or hazardous protrusions.
		PYRO-27	Incorporate integral hoisting provisions at each weapon/store station to enable direct lift from the container or carrier to the attachment hardpoints.
		PYRO-32	Provide sufficient longitudinal clearance between weapon bays to enable simultaneous loading of two bays.

Guidelines by Category (Cont'd)

Category No.	Category Title	Guideline No.	Guideline
3.08.03	Cartridge Actuated Devices, Shaped Charges, Detonating Cord, and Pyrotechnic Devices	PYRO-33	Provide sufficient lateral clearance between weapon bays to enable simultaneous loading of two bays.
		PYRO-34	Weapon bay door seals should be bonded or attached to door structure to minimize induced seal damage during weapon or store loading.
		PYRO-35	Suspension system should permit any single weapon or store to be loaded by a two man crew.
		PYRO-36	Suspension system design and spacing should enable any combination of eight weapons to be loaded by two two-man crews within the refueling time of the vehicle (excludes nuclear weapons).
		PYRO-37	Internal weapon suspension arrangements should preclude sequential weapon loading.
		PYRO-38	Any single pylon or built-up pylon/weapon package should have the capability for rapid reconfiguration.
		PYRO-39	Weapon bay ejectors and launchers should have the capability for total interchangeability and reconfigurability.
		PYRO-40	All weapon and store loading functions should be within the percentile range of 5% female to 95% male standing at ground level.
		PYRO-41	Weapon or store handling and transportation equipment should be compatible with rough terrain and capable of 25 mph towing speeds minimum.
		PYRO-42	In weapons carriage design and integration, avoid dependence of on-board high pressure nitrogen.
		PYRO-43	Launcher or ejector design/interface should not require a dual function of carrying airframe structural loads.
		PYRO-44	Launcher and ejector design should incorporate automatic sway bracing.
		PYRO-45	Missile ejectors should be provided with repeatable missile motor fire wires to simplify loading and reduce elapsed time.
		PYRO-46	Design pylons, launchers, and ejector racks so that weapon loading, servicing, and reconfigurations can be accomplished using standard hand tools.
		PYRO-47	Installation design of ejectors, launchers, racks, and associated hardware interfaces should avoid reliance on torque wrenches.
		SABCH-02	All flush type structural screws should have identical head drives for the entire vehicle.
		SABCH-03	All non-flush type structural screws should have identical head drive recesses for the entire vehicle.
		SABCH-04	Special high strength bolts, such as twelve-point heads, should be fully justified from standpoint of the cost of ownership and effectiveness.
		SABCH-05	Structural design should avoid the reliance on blind fasteners unless fully supported by cost, weight, schedule, and effectiveness analysis.
		SEAT-01	Design personnel seats and padding materials, including the covers and fillers, so they are incapable of creating or emitting toxic fumes or dense smoke when subjected to fire.
		SEAT-03	Do not use seat and padding materials that can create static electricity in pyrotechnic or combustible fluid environments.
		SEAT-04	Design ejection seats so they can be replaced with canopy or escape hatch installed.
		SEAT-05	Design ejection seat pyrotechnic devices so they are 100 percent viewable and accessible with seat installed.
		SI-03	Parts and assemblies of a given model product or of models of a product in the same series should be interchangeable or replaceable.
		T-01	Do not locate pyro, gas, and air (PGA) control system exhaust exits: <ul style="list-style-type: none"> - In proximity to safe, arm, or servicing areas, - Adjacent to auxiliary inlets, - In close proximity to crew boarding areas, weapons, emergency ingress/egress areas, and optics or optical glass.
		T-02	Design pyro type thruster exits associated with emergency use or backup with simple exit closure devices to identify if a thruster has been fired.
		T-03	Provide protective screens for PGA exits that normally remain open to prevent intrusions from fowl or wildlife.
		T-04	Provide protective closure provisions for PGA exits located or oriented to exposure from the elements.
		T-05	Design single-shot (one time use) type thrusters with a minimum 6-year shelf life and a 7-year installed life.
		WBAY-16	Gap seals should not degrade loading while wearing arctic or chemical, biological, or radiation protective clothing.

Guidelines by Category (Cont'd)

Category No.	Category Title	Guideline No.	Guideline
3.08.03	Cartridge Actuated Devices, Shaped Charges, Detonating Cord, and Pyrotechnic Devices	WBAY-17	Special coatings or conductive paints on pylons, launchers, racks, launchers, tanks, pods, etc. should have the durability to withstand contact with support stands/cradles during storage.
3.09	Fluid Systems	A-07	Paint equipment bay and compartment interiors a high gloss white to maximize lighting reflectivity, visibility, and rapid leak detection capability.
		A-10	Provide a sufficient number of compartment fluid drains to ensure fluid drainage for varying aircraft static attitudes and varying terrain slopes for ground vehicles.
		A-13	Two-sided or two-surfaced access should not be required for access to equipment interfaces and hardpoints. The term two-sided infers top/bottom, left/right, front/back, or combinations thereof.
		A-14	Do not locate nutplates or gang channels in inaccessible areas that would require extensive disassembly or equipment removal to gain access.
		A-15	Locate tie-down attachment points such that tie-down chains, straps, or cables do not prevent or restrict normal servicing, weapon loading, or safe/arm functions.
		A-18	Use transparent windows, quick-opening covers, or openings without any cover to permit quick visual inspections where needed.
		ARM-05	All servicing and turnaround functions (including movement envelopes) should be outside the gun firing envelope.
		BIT-01	During design of the BIT, use worst-case stress analysis to ensure that any circuit failures induced by temperature extremes, tolerance build-up, power supply variations, and combinations thereof are identified.
		BIT-02	Ensure that BIT system thresholds are consistent with those across the system, subsystem, item, module, and piece-part levels to prevent excessive numbers of Cannot Duplicate (CND) and Retest OK (RTOK) events from occurring.
		BIT-03	The degree of BIT required or proposed should be based on the respective failure rates and the appropriate FMECA at all equipment indenture levels.
		BIT-04	Limit the amount of data that is recorded to a manageable size by: <ul style="list-style-type: none"> - Limiting the number of signals that are monitored - Limiting the maximum sampling rate - Reducing the time span over which data is accumulated - Restricting the type of data accumulated
		BIT-05	Incorporate testability design features as an integral part of equipment preliminary design process.
		BIT-06	Mission critical functions should be monitored by BIT.
		BIT-09	Use concurrent BIT to monitor system critical functions.
		BIT-16	Critical voltages should be visually monitored by sending the voltage signals to visible LEDs.
		BIT-20	The BIT should be mechanized so that when a piece of equipment is not installed in a subsystem or the product, a failure will not be indicated.
		BIT-26	Locate routinely used test points so they are accessible without removing or disassembling other equipment
		C-01	Avoid swivel type connectors and fittings for air, fuel, or hydraulic line interfaces due to their history of low reliability.
		C-02	Provide spacing between parallel plumbing runs so that in-line couplings can be replaced without removing lines or disconnecting any line support devices.
		CBR-01	Orient all vehicle liquid servicing fittings to ensure fluids will not come in contact with protective garb during connect/disconnect activities.
		CBR-02	Ensure vehicle overboard passive liquid drains are clearly marked or visible to enable personnel to remain clear of area.
		CBR-03	Design fuel cell drains so they can not be activated in a manner that would allow fuel to come in contact with a protected hand.
		D&V-01	The geometric aspects of structural design and interfaces should not result in any natural bathtubs.
		D&V-02	Structural sections subject to condensation or fluid migration should contain drainage provisions.
		D&V-03	Crew cabs, operators' compartments, crew stations, cockpits, and passenger compartments should be subject to the same corrosion prevention measures as the exteriors of the vehicles. Low points, pockets, and related fluid collection points within should be provided with low point drains.

Guidelines by Category (Cont'd)

Category No.	Category Title	Guideline No.	Guideline
3.09	Fluid Systems		
		ECS-01	Design so that equipment servicing status are accessible and readable from the ground level for air vehicles and from the operator's position for ground and water vehicles.
		ECS-03	Heat exchangers using hot liquids as the heat source should not be located inside the compartments used for operator, crew, or passengers.
		ECS-04	Plumbing, lines, or hoses containing hot liquids, toxic gases or liquids should be external to operator, crew, or passenger stations.
		ECS-07	Liquid type refrigeration compressors/packages should contain highly reliable quick disconnects to negate servicing or bleeding subsequent to replacement.
		ECS-08	All liquid type refrigeration compressors and packages stocked as spares should be pre-serviced wherein the servicing is compatible with the shelf life of the unit.
		ECS-10	The power actuation source used for valves that direct or control air, gas, or liquid flow should be parasitic to the valve body to enable replacement without disturbing the integrity of the lines, ducts, or plenums.
		ENG(G)-06	The distance between the engine and firewall should ensure the access envelopes to lines, fittings, wiring, and adjustments will accommodate the 75 percentile male hand.
		ENG(G)-10	Design attaching hardware for all mechanical engine-to-vehicle interfaces to be captive and with integral safeties.
		ENG(G)-12	Provide a clear and viewable access envelope to fuel and oil filters.
		ENG(G)-13	Locate fuel filters to ensure no safety hazard will exist due to residual fuel during filter change.
		ENG(G)-15	Any single drive belt (excluding timing belts) should be capable of replacement within 30 minutes elapsed time
		ENG(G)-18	Incorporate appropriate sensors to enhance the diagnostic and prognostic capabilities for the following: <ul style="list-style-type: none"> - Fuel filter bypass - Oil temperature - Oil pressure - Oil filter bypass - Oil cooler bypass valve position - Oil level - Oil return line particle count
		ENG(G)-20	Design all firewall fittings, connectors, and penetrations to be fully viewable and directly accessible to the maintainers.
		ENG-02	Each different component of rotating machinery should contain different tracer elements to enhance EEMS and IDM isolation and tracking of wear.
		ENG-03	Digital electronic controls, fully automatic digital electronic controls, and similar concepts should contain the highest degree of BIT and diagnostics commensurate with affordability, operation and maintenance, and life cycle costs as appropriate.
		ENG-04	The engine and engine-mounted gear box should have individual oil supplies to ensure wear or failures in one will not contaminate or fail the other.
		ENG-05	All engine-mounted air and fluid lines should be located next to the fan case, engine case, or full-length fan duct to ensure quick and simple replacement of accessories and components.
		ENG-06	All other engine surfaces and engine-mounted accessory surfaces should be free of pockets, channels, and bathtubs that could trap and retain fluids.
		ENG-10	On multi-engine air vehicles, the airframe-to-engine interfaces should be in identical positions or orientations for each engine cavity.
		ENG-13	Engine oil systems should contain on-board spectrometric oil analysis devices located on the engine.
		ENG-14	Coring of engine gear box cases and housings to provide for fuel heat sink routing should take precedence over dedicated fuel or oil heat exchangers.
		ENG-22	The engine cavity structure should be capable of withstanding a 2000-degree Fahrenheit fire for 10 minutes without jeopardizing loss of the vehicle.
		ENG-25	All engine-to-airframe plumbing, wiring, and duct interfaces should be capable of being connected or disconnected by hand, should contain integral safety provisions, and should not require torquing.
		ENG-27	No rigging or calibration should be required following engine replacement.

Guidelines by Category (Cont'd)

Category No.	Category Title	Guideline No.	Guideline
3.09	Fluid Systems		
		ENG-28	No engine operational start and checkout should be required following engine replacement.
		ENG-47	Design the engine, including all accessories, plumbing, wiring, ducts, and mechanisms, to meet the same environmental protection and compatibility requirements as the host vehicle.
		ENG-48	Do not drain or dump residual fuel in the engine fuel control/manifold overboard. When it is not possible to follow this guideline, route the fuel to an engine-mounted collector tank capable of retaining fuel from two shutdowns.
		ENG-49	Design engine fuel and oil filters with integral locking features so they can be installed and removed by hand, and require no torquing.
		ENG-50	Design engine fuel and oil filter delta pressure indicators so they can be reset only from within the filter housing.
		ENG-51	Provide engine fuel and oil filters with anti-surge protection to ensure false delta pressure indications do not occur.
		FUEL-01	Locate fuel vent and dump masts to ensure exiting fuel will be clear of servicing, loading, arming and safing areas for all types of ground and airborne vehicles.
		FUEL-02	Manufacturing splices for major sub-assemblies should not intrude into or through integral fuel cells or tanks.
		FUEL-03	Structural bolts, screws, and fasteners should not penetrate into integral fuel cells or tanks other than those used for access door attachment.
		FUEL-04	Where the fuel wetted area inside a fuel cell or tank is void of blade, knife, and hat stiffeners for use as hardpoint attachment, standoffs bonded to the cell surface should be used as attachments for clamps, and brackets to eliminate fastener penetration of the fuel cavity.
		FUEL-05	Intersecting of two or more surfaces in a fuel wetted area of less than 90 degrees should be avoided to simplify manufacture and repair.
		FUEL-06	Where maintaining a minimum angle of 90 degrees is not possible, sufficient depth, width, and height should be maintained to provide tool clearances for all tools used in the manufacturing processes and in the operational field repair environment.
		FUEL-07	When feed tanks are designed such that the lower portion of the tank serves as a surge chamber, the top closure deck of the surge chamber should provide the strength to support the weight of a 95 percentile male.
		FUEL-08	The size and number of fuel cell and tank access doors should be sufficient to ensure no wetted area of the cell or tank is beyond a maximum 18" distance from the edge of the access opening. This guideline applies to only non-man rated cells.
		FUEL-09	All fuel cell or tank access doors not mounted on the exterior surface should contain sealing provisions other than the channel type.
		FUEL-10	Provide access from the wing closure ribs in lieu of the moldline when access is required in close proximity to the wing fold area.
		FUEL-11	Through-the-tank fasteners should not be used for fuel cells or tanks in areas where a leak path could be established into an inaccessible portion of the vehicle.
		GBD-01	Guidelines for transmissions, clutches, and rotors apply.
		GBD-02	Use the host gear box lubricating system to provide lubrication of the drive shaft spline.
		GBD-03	Design drive shafts using the "blind spline" concept to ensure correct mating of the shaft to the gear box.
		GBD-04	Design drive shafts with a simple, light-weight cover to protect personnel.
		GBD-05	Design drive shaft covers with a hole or slot type opening to prevent the masking of leakage or damage.
		HYD-01	For military combat vehicles having two or more hydraulic power systems, provide a minimum 30-inch spacing between ground power and servicing interfaces to ensure: <ul style="list-style-type: none"> - Design flexibility in locating and arranging equipment in high-density vehicles such as fighters and helicopters, - Work area separation to enable concurrent service/maintenance on systems, - Systems vulnerability enhancement, - Reduction in turn-around elapsed time due to concurrent servicing capability.
		HYD-02	Use identical components, such as pumps, reservoirs, and accumulators, in each individual power subsystem. In instances where this is not fully possible, perform and document trade studies or appropriate analysis to provide justification and supporting rationale.

Guidelines by Category (Cont'd)

Category No.	Category Title	Guideline No.	Guideline
3.09	Fluid Systems		
		HYD-03	Use identical types of fluid in all hydraulic subsystems. Brakes may be the exception only if the system is totally separated from the independent of other hydraulic systems.
		HYD-04	For vehicles containing two or more systems with different fluids, use different service fittings and different ground power interfaces for each fluid type.
		HYD-05	Design protective caps or covers over service fittings with steel cable lanyards to prevent loss and migration in the vehicle.
		HYD-06	Mount hydraulic pumps to the gear box flange with v-band clamps containing a torq-set or equivalent fastener.
		HYD-07	Modularize electric-driven hydraulic pumps to enable replacement of the drive motor without interruption of the fluid lines.
		HYD-08	Design hydraulic pumps and motors with tracer elements to detect wear through on-board spectrometric oil analysis devices.
		HYD-09	Provide hydraulic devices used in critical applications with integral 5 micron filtering.
		HYD-10	Design the fluid storage system so it can be serviced in one-quart increments to eliminate the effects of handling and storing partially-filled cans.
		HYD-11	Design flexible hose with molded-in color bands to clearly indicate when the maximum wear/abrasion has been reached.
		LG-12	All struts should contain a spare strut lower seal stowed in the strut collar to avoid removing the lower strut for leak repair.
		MC-01	All clamps should contain torque-set or torque-limiting connections to prevent clamp or component failure due to over-torque. Clamp installation call outs should not depend on special tools to establish the required torque values.
		MC-02	Avoid the use of cotter pins, safety wire, safety clips, and similar devices to prevent maintenance-induced events leading to ground vehicle accidents or loss of air vehicles.
		MC-03	All tubing connections and interfaces should use rosan/dynatube (or equivalent) to (1) enable connect or disconnect with one hand, one tool, (2) eliminate the need to safety the connection, (3) provide a superior seal, and (4) negate need to reposition line(s) during component replacement.
		MC-04	No trombone type, flared tube type, or piloted line type interfaces should be used to avoid the need for removal or repositioning during equipment removal.
		MC-05	Avoid potential foreign object traps during manufacturing or operational maintenance by eliminating vertical penetrations of plumbing/fittings into tanks, compartments, or cells
		MC-06	Locate, position, orient all plumbing and duct electrical connectors to prevent the need for sequential installation or removal.
		MC-07	Maximize areas of constant web thickness in firewalls, carry-through bulkheads, major frames, structural ribs, spars, webs, keels, and close-outs to provide flexibility in locating penetration fittings. Stepped chem milling, stepped machining, stepped composite layup concepts all tend to result in minimal available surface area for penetrations.
		MC-08	All in-line plumbing connections within a fuel tank or cell should be capable of making/breaking the interface by hand, require no torque, contain integral safety locking mechanisms, and should be void of any requirement for safety wire.
		MC-09	All plumbing connections and fittings used for fuel systems should contain integral bonding features to eliminate the need for bonding clamps or jumper cables.
		MC-10	In rare instances where a plumbing run contains complex form or geometry that would require removal of other plumbing or equipment for access, in-line connectors should be incorporated to maintain the integrity of other plumbing or equipment.
		MC-11	No subsystem plumbing, equipment, or wiring should use a tank, cell, or compartment containing liquids as a means for routing or penetration simplicity during manufacture.
		MC-12	All plumbing and connectors containing liquids should be meniscus-free.
		MC-13	In instances where plumbing or connector interfaces cannot or are not keyed for a specific orientation, all identification, markings, cautions, and directions should be placed 360 degrees around the tube or duct.

MIL-HDBK-470A

APPENDIX C

Guidelines by Category (Cont'd)

Category No.	Category Title	Guideline No.	Guideline
3.09	Fluid Systems	MC-14	Where multiple connectors are located in close proximity, ensure (1) a minimum hand tool arc of 120 degrees can be maintained, and (2) stagger fittings to ensure firm coupling interface/hand tool interface can be accomplished without inducing damage to adjacent lines.
		MP-01	Avoid the use of epoxies to mount parts on repairable modules because they make repair extremely difficult.
		MP-02	Use a unique identification (ID) resistor incorporated in each system module to verify that the proper module is mounted on ATE.
		MP-03	Design modules so that lengthy warm-up times, special coding and air purity levels, and similar constraints are not necessary.
		OXY-05	Locate liquid oxygen (LOX) containers in a sealed, dedicated compartment to eliminate need for frequent visual inspections.
		P-01	Access door and panel fastener types for airborne vehicles should meet the following criteria: <ul style="list-style-type: none"> - use latches for a frequency of access of 0 to 40 flight hours - use High Strength Quick Release fasteners for a frequency of access of 40-400 flight hours - use structural screws for a frequency of access of 400 flight hours or more
		P-02	Access door and panel fastener types for surface vehicles should meet the following criteria: <ul style="list-style-type: none"> - use a spring loaded or latch fastener for an opening frequency of daily - use a one quarter turn fastener (or equivalent) for an opening frequency of weekly - use screws or bolts for all other cases
		P-03	All doors and panels subject to environmental elements should contain form-in-place seals (or equivalent) attached to the door structure, not substructure, to prevent damage during maintenance.
		P-04	Door and panel seals should be compatible with all types of on-board servicing fluids, de-ice and anti-ice fluids, and all fluids used for chemical, biological, and nuclear decontamination.
		P-05	Piano type hinges should not be used on doors or panels because they are subject to wear, corrosion, and sand and fluid entry.
		P-06	Access door and panel devices used to support door in opened position should meet the following criteria: <ul style="list-style-type: none"> - for airborne vehicles, design for 60 knot gust loads (or equivalent jet blast loads) - for ground vehicles, design for 50 mph gust loads
		P-07	Hinged access doors and panels capable of remaining in the opened position should not have sharp edges or corners.
		P-08	Removable access door and panel fasteners should be of identical grip length and diameter.
		P-09	Acceptable door and panel hold-open devices include over-center sheet metal spring, over-center spring link, spring cartridge, support strut, and pinned goose neck hinge.
		P-10	Access doors and panels requiring non-captive fasteners should not be located forward of air inlet ducts or high-energy rotating components (e.g., prop fans, engine cooling fans, etc.).
		P-11	Access doors and panels should be interchangeable as justified by operation and support costs or life cycle costs.
		SABCH-02	All flush type structural screws should have identical head drives for the entire vehicle.
		SABCH-03	All non-flush type structural screws should have identical head drive recesses for the entire vehicle.
		SABCH-04	Special high strength bolts, such as twelve-point heads, should be fully justified from standpoint of the cost of ownership and effectiveness.
		SABCH-05	Structural design should avoid the reliance on blind fasteners unless fully supported by cost, weight, schedule, and effectiveness analysis.
		SEAT-02	Design personnel seats and padding materials so they are incapable of absorbing and holding fluids.
		SI-03	Parts and assemblies of a given model product or of models of a product in the same series should be interchangeable or replaceable.
		WBAY-09	Gap seal/pylon should not cover or hamper access to low point wing drains.

Guidelines by Category (Cont'd)

Category No.	Category Title	Guideline No.	Guideline
3.09.01	Fuel Systems, Tanks, Containers, Pumps, Trucks, and Bladders	A-01	Seal equipment bays and compartments against the environmental elements including all types of servicing fluids used for the vehicle, all types of anti-ice and de-ice fluids, and all types of fluids used for chemical, biological, or nuclear decontamination
		A-02	Equipment bay and compartment structure should be bonded, co-cured, welded, machined, or combinations thereof to eliminate or minimize the use of mechanical fasteners.
		A-03	All equipment bay and compartment structural flanges and stiffeners should be external to the compartment to maximize the volume available for equipment installation and arrangement.
		A-04	Use stiffening beads in lieu of flanges to the maximum extent to enhance compartment volume and simplify repairs.
		A-05	Stiffening beads should have the convex surface toward the compartment to eliminate fluid traps.
		A-06	Keep all machined compartment frames, webs, and closure panels to a constant thickness (e.g., not stepped or tapered) to ease simplicity of fluid or electrical penetrations and ease and simplicity of structural repair.
		A-08	Hardpoints (structural attachment and load bearing areas) within a compartment to assist in equipment mounting or support should not be integral with the machined part. Hardpoints should be parasitic to enable quick repair in case of wear or damage in lieu of precise ream/bush repair typical of machined hardpoints.
		A-11	Plumbing penetrations into a compartment should not be on a vertical axis due to difficulty in making or breaking vertically-oriented connections. When compartment access is from the bottom, vertically-oriented connections can allow fluid to leak onto the maintainer. When access is from the top, such connections can allow foreign matter to enter the line. Use horizontal penetrations whenever possible.
		A-12	Locate compartment electrical penetrations close to the access opening for ease of sight, probing, repair, and to eliminate fluid soaking, wicking, or contamination.
		ARM-05	Locate compartment electrical penetrations far enough from the access opening to prevent damage resulting from improper (over-length) panel fasteners.
		BIT-01	All servicing and turnaround functions (including movement envelopes) should be outside the gun firing envelope.
		BIT-02	During design of the BIT, use worst-case stress analysis to ensure that any circuit failures induced by temperature extremes, tolerance build-up, power supply variations, and combinations thereof are identified.
		BIT-03	Ensure that BIT system thresholds are consistent with those across the system, subsystem, item, module, and piece-part levels to prevent excessive numbers of Cannot Duplicate (CND) and Retest OK (RTOK) events from occurring.
		BIT-04	The degree of BIT required or proposed should be based on the respective failure rates and the appropriate FMECA at all equipment indenture levels.
			Limit the amount of data that is recorded to a manageable size by:
			- Limiting the number of signals that are monitored
			- Limiting the maximum sampling rate
			- Reducing the time span over which data is accumulated
			- Restricting the type of data accumulated
		BIT-05	Incorporate testability design features as an integral part of equipment preliminary design process.
		BIT-06	Mission critical functions should be monitored by BIT.
		BIT-09	Use concurrent BIT to monitor system critical functions.
		BIT-16	Critical voltages should be visually monitored by sending the voltage signals to visible LEDs.
		BIT-20	The BIT should be mechanized so that when a piece of equipment is not installed in a subsystem or the product, a failure will not be indicated.
		BIT-26	Locate routinely used test points so they are accessible without removing or disassembling other equipment
		C-01	Avoid swivel type connectors and fittings for air, fuel, or hydraulic line interfaces due to their history of low reliability.
		C-02	Provide spacing between parallel plumbing runs so that in-line couplings can be replaced without removing lines or disconnecting any line support devices.
		CBR-01	Orient all vehicle liquid servicing fittings to ensure fluids will not come in contact with protective garb during connect/disconnect activities.
		CBR-02	Ensure vehicle overboard passive liquid drains are clearly marked or visible to enable personnel to remain clear of area.

MIL-HDBK-470A

APPENDIX C

Guidelines by Category (Cont'd)

Category No.	Category Title	Guideline No.	Guideline
3.09.01	Fuel Systems, Tanks, Containers, Pumps, Trucks, and Bladders	CBR-03	Design fuel cell drains so they can not be activated in a manner that would allow fuel to come in contact with a protected hand.
		D&V-01	The geometric aspects of structural design and interfaces should not result in any natural bathtubs.
		D&V-02	Closed structural sections subject to condensation or fluid migration should contain drainage provisions.
		D&V-03	Crew cabs, operators' compartments, crew stations, cockpits, and passenger compartments should be subject to the same corrosion prevention measures as the exteriors of the vehicles. Low points, pockets, and related fluid collection points within should be provided with low point drains.
		EC-12	Electrical penetrations into a compartment should not be on a vertical axis to ensure foreign matter does not enter connector.
		ENG(G)-06	The distance between the engine and firewall should ensure the access envelopes to lines, fittings, wiring, and adjustments will accommodate the 75 percentile male hand.
		ENG(G)-10	Design attaching hardware for all mechanical engine-to-vehicle interfaces to be captive and with integral safeties.
		ENG(G)-12	Provide a clear and viewable access envelope to fuel and oil filters.
		ENG(G)-13	Locate fuel filters to ensure no safety hazard will exist due to residual fuel during filter change.
		ENG(G)-15	Any single drive belt (excluding timing belts) should be capable of replacement within 30 minutes elapsed time
		ENG(G)-18	Incorporate appropriate sensors to enhance the diagnostic and prognostic capabilities for the following: <ul style="list-style-type: none"> - Oil temperature - Fuel filter bypass - Oil pressure - Coolant pressure - Oil filter bypass - Coolant level - Oil cooler bypass valve position - Coolant temperature - Oil level - Vibration pickups - Oil return line particle count - Chip detector
		ENG(G)-20	Design all firewall fittings, connectors, and penetrations to be fully viewable and directly accessible to the maintainers.
		ENG-02	Each different component of rotating machinery should contain different tracer elements to enhance EEMS and IDM isolation and tracking of wear.
		ENG-05	All engine-mounted air and fluid lines should be located next to the fan case, engine case, or full-length fan duct to ensure quick and simple replacement of accessories and components.
		ENG-06	All other engine surfaces and engine-mounted accessory surfaces should be free of pockets, channels, and bathtubs that could trap and retain fluids.
		ENG-10	On multi-engine air vehicles, the airframe-to-engine interfaces should be in identical positions or orientations for each engine cavity.
		ENG-20	Do not locate equipment or components in the engine cavity except for those components associated with the engine or engine installation.
		ENG-21	Do not locate equipment or components in the engine bay cavity in a manner that would require removal or repositioning for engine removal.
		ENG-22	The engine cavity structure should be capable of withstanding a 2000-degree Fahrenheit fire for 10 minutes without jeopardizing loss of the vehicle.
		ENG-25	All engine-to-airframe plumbing, wiring, and duct interfaces should be capable of being connected or disconnected by hand, should contain integral safety provisions, and should not require torquing.
		ENG-27	No rigging or calibration should be required following engine replacement.
		ENG-28	No engine operational start and checkout should be required following engine replacement.
		ENG-31	No rigging or calibration should be required subsequent to replacement of any engine-mounted component.
		ENG-32	Design the engine fuel controls and electronic controllers so that no manual fuel grade adjustments are required.
		ENG-37	Gravity type servicing fittings, covers, and caps should have integral locking features, openable by hand, and contain a cable or chain to prevent loss or dropping.

Guidelines by Category (Cont'd)

Category No.	Category Title	Guideline No.	Guideline
3.09.01	Fuel Systems, Tanks, Containers, Pumps, Trucks, and Bladders	ENG-45	Provide remote servicing points accessible from the ground to service engine accessories mounted on top of the engine (e.g., oil tanks, gear boxes, generators, etc.) to eliminate climbing upon or atop the host vehicle.
		ENG-46	Design the basic engine and engine-mounted accessory interface so that no fluid traps or bathtubs exist regardless of engine-mounted accessory location.
		ENG-47	Design the engine, including all accessories, plumbing, wiring, ducts, and mechanisms, to meet the same environmental protection and compatibility requirements as the host vehicle.
		ENG-48	Do not drain or dump residual fuel in the engine fuel control/manifold overboard. When it is not possible to follow this guideline, route the fuel to an engine-mounted collector tank capable of retaining fuel from two shutdowns.
		ENG-49	Design engine fuel and oil filters with integral locking features so they can be installed and removed by hand, and require no torquing.
		ENG-50	Design engine fuel and oil filter delta pressure indicators so they can be reset only from within the filter housing.
		ENG-51	Provide engine fuel and oil filters with anti-surge protection to ensure false delta pressure indications do not occur.
		EXT-01	Locate Tanks, Pods, Containers, and Devices (TPCD's) so they do not block or restrict access to existing vehicle access areas or access approach envelopes.
		EXT-04	Design TPCD's used for fuel containment so that post-installation operational tests or checks are not required.
		EXTING-01	Use extinguishing concepts dedicated to each individual fire zone in preference to manifold systems operating from a central source.
		EXTING-03	Keep each individual fire zone over-temperature/fire warning system separate from those in other fire zones.
		EXTING-04	Design individual fire zone over-temperature/fire warning system to be fully BIT capable (the BIT concept should permit both initiated and periodic BIT).
		EXTING-06	Provide an alternate capability to activate the system remotely from the cockpit/crew station, or operator's position to satisfy emergency situations during vehicle maintenance.
		EXTING-07	Analyze the vehicle operational environment and type of fire zones to determine if remote stop/shut-off of equipment is warranted.
		EXTING-08	Analyze the vehicle operational environment and type of fire zones to determine if remote alarm and/or visual indication of a fire is warranted.
		EXTING-09	Do not locate provisions for overboard venting or dumping of extinguishing agents in areas that could create hazards for personnel.
		FUEL-01	Locate fuel vent and dump masts to ensure exiting fuel will be clear of servicing, loading, arming and safing areas for all types of ground and airborne vehicles.
		FUEL-02	Manufacturing splices for major sub-assemblies should not intrude into or through integral fuel cells or tanks.
		FUEL-03	Structural bolts, screws, and fasteners should not penetrate into integral fuel cells or tanks other than those used for access door attachment.
		FUEL-04	Where the fuel wetted area inside a fuel cell or tank is void of blade, knife, and hat stiffeners for use as hardpoint attachment, standoff bonded to the cell surface should be used as attachments for clamps, and brackets to eliminate fastener penetration of the fuel cavity.
		FUEL-05	Intersecting of two or more surfaces in a fuel wetted area of less than 90 degrees should be avoided to simplify manufacture and repair.
		FUEL-06	Where maintaining a minimum angle of 90 degrees is not possible, sufficient depth, width, and height should be maintained to provide tool clearances for all tools used in the manufacturing processes and in the operational field repair environment.
		FUEL-07	When feed tanks are designed such that the lower portion of the tank serves as a surge chamber, the top closure deck of the surge chamber should provide the strength to support the weight of a 95 percentile male.
		FUEL-08	The size and number of fuel cell and tank access doors should be sufficient to ensure no wetted area of the cell or tank is beyond a maximum 18" distance from the edge of the access opening. This guideline applies to only non-man rated cells.
		FUEL-09	All fuel cell or tank access doors not mounted on the exterior surface should contain sealing provisions other than the channel type.

Guidelines by Category (Cont'd)

Category No.	Category Title	Guideline No.	Guideline
3.09.01	Fuel Systems, Tanks, Containers, Pumps, Trucks, and Bladders	FUEL-10	Provide access from the wing closure ribs in lieu of the moldline when access is required in close proximity to the wing fold area.
		FUEL-11	Through-the-tank fasteners should not be used for fuel cells or tanks in areas where a leak path could be established into an inaccessible portion of the vehicle.
		HYD-09	Provide hydraulic devices used in critical applications with integral 5 micron filtering.
		MC-01	All clamps should contain torque-set or torque-limiting connections to prevent clamp or component failure due to over-torque. Clamp installation call outs should not depend on special tools to establish the required torque values.
		MC-02	Avoid the use of cotter pins, safety wire, safety clips, and similar devices to prevent maintenance-induced events leading to ground vehicle accidents or loss of air vehicles.
		MC-03	All tubing connections and interfaces should use rosan/dynatube (or equivalent) to (1) enable connect or disconnect with one hand, one tool, (2) eliminate the need to safety the connection, (3) provide a superior seal, and (4) negate need to reposition line(s) during component replacement.
		MC-04	No trombone type, flared tube type, or piloted line type interfaces should be used to avoid the need for removal or repositioning during equipment removal.
		MC-05	Avoid potential foreign object traps during manufacturing or operational maintenance by eliminating vertical penetrations of plumbing/fittings into tanks, compartments, or cells.
		MC-06	Locate, position, orient all plumbing and duct electrical connectors to prevent the need for sequential installation or removal.
		MC-07	Maximize areas of constant web thickness in firewalls, carry-through bulkheads, major frames, structural ribs, spars, webs, keels, and close-outs to provide flexibility in locating penetration fittings. Stepped chem milling, stepped machining, stepped composite layup concepts all tend to result in minimal available surface area for penetrations.
		MC-08	All in-line plumbing connections within a fuel tank or cell should be capable of making/breaking the interface by hand, require no torque, contain integral safety locking mechanisms, and should be void of any requirement for safety wire.
		MC-09	All plumbing connections and fittings used for fuel systems should contain integral bonding features to eliminate the need for bonding clamps or jumper cables.
		MC-10	In rare instances where a plumbing run contains complex form or geometry that would require removal of other plumbing or equipment for access, in-line connectors should be incorporated to maintain the integrity of other plumbing or equipment.
		MC-11	No subsystem plumbing, equipment, or wiring should use a tank, cell, or compartment containing liquids as a means for routing or penetration simplicity during manufacture.
		MC-12	All plumbing and connectors containing liquids should be meniscus-free.
		MC-13	In instances where plumbing or connector interfaces cannot or are not keyed for a specific orientation, all identification, markings, cautions, and directions should be placed 360 degrees around the tube or duct.
		MC-14	Where multiple connectors are located in close proximity, ensure (1) a minimum hand tool arc of 120 degrees can be maintained, and (2) stagger fittings to ensure firm coupling interface/hand tool interface can be accomplished without inducing damage to adjacent lines.
		MC-15	Route, orient, and position plumbing, wiring, ducts, and connectors sufficiently away from the outer surface of the vehicle to preclude induced damage due to minor dents, drill bits during repair, etc. Minimum rule of thumb is 1" away from the inner surface and 1" below a plate nut channel.
		MP-01	Avoid the use epoxies to mount parts on repairable modules because they make repair extremely difficult.
		MP-02	Use a unique identification (ID) resistor incorporated in each system module to verify that the proper module is mounted on ATE.
		MP-03	Design modules so that lengthy warm-up times, special coding and air purity levels, and similar constraints are not necessary.

Guidelines by Category (Cont'd)

Category No.	Category Title	Guideline No.	Guideline
3.09.01	Fuel Systems, Tanks, Containers, Pumps, Trucks, and Bladders	P-01	Access door and panel fastener types for airborne vehicles should meet the following criteria: <ul style="list-style-type: none"> - use latches for a frequency of access of 0 to 40 flight hours - use High Strength Quick Release fasteners for a frequency of access of 40-400 flight hours - use structural screws for a frequency of access of 400 flight hours or more
		P-02	Access door and panel fastener types for surface vehicles should meet the following criteria: <ul style="list-style-type: none"> - use a spring loaded or latch fastener for an opening frequency of daily - use a one quarter turn fastener (or equivalent) for a opening frequency of weekly - use screws or bolts for all other cases
		P-03	All doors and panels subject to environmental elements should contain form-in-place seals (or equivalent) attached to the door structure, not substructure, to prevent damage during maintenance.
		P-04	Door and panel seals should be compatible with all types of on-board servicing fluids, de-ice and anti-ice fluids, and all fluids used for chemical, biological, and nuclear decontamination.
		P-05	Piano type hinges should not be used on doors or panels because they are subject to wear, corrosion, and sand and fluid entry.
		P-06	Access door and panel devices used to support door in opened position should meet the following criteria: <ul style="list-style-type: none"> - for airborne vehicles, design for 60 knot gust loads (or equivalent jet blast loads) - for ground vehicles, design for 50 mph gust loads
		P-07	Hinged access doors and panels capable of remaining in the opened position should not have sharp edges or corners.
		P-08	Removable access door and panel fasteners should be of identical grip length and diameter.
		P-09	Acceptable door and panel hold-open devices include over-center sheet metal spring, over-center spring link, spring cartridge, support strut, and pinned goose neck hinge.
		P-10	Access doors and panels requiring non-captive fasteners should not be located forward of air inlet ducts or high-energy rotating components (e.g., prop fans, engine cooling fans, etc.).
		P-11	Access doors and panels should be interchangeable as justified by operation and support costs or life cycle costs.
		SABCH-02	All flush type structural screws should have identical head drives for the entire vehicle.
		SABCH-03	All non-flush type structural screws should have identical head drive recesses for the entire vehicle.
		SABCH-04	Special high strength bolts, such as twelve-point heads, should be fully justified from standpoint of the cost of ownership and effectiveness.
		SABCH-05	Structural design should avoid the reliance on blind fasteners unless fully supported by cost, weight, schedule, and effectiveness analysis.
		SABCH-11	In rare instances where the use of dissimilar material in immediate contact cannot be avoided, they should be sufficiently insulated to endure for the life of the vehicle.
		SABCH-12	Avoid tapping threads into structural members. Use of heli-coil type or similar insert concepts is permissible.
		SABCH-13	No structural design concept should rely on frequent scheduled inspections to monitor or otherwise ensure structural integrity.
		SABCH-14	No structural fastener intended to carry shear or tension loads should be smaller than 1/4" diameter (.25").
		SABCH-15	Give preference to butt type splices over lap type splices in the design of manufacturing splices.
		SEAT-02	Design personnel seats and padding materials so they are incapable of absorbing and holding fluids.
		SI-03	Parts and assemblies of a given model product or of models of a product in the same series should be interchangeable or replaceable.
		WBAY-09	Gap seal/pylon should not cover or hamper access to low point wing drains.
		A-08	Plumbing penetrations into a compartment should not be on a vertical axis due to difficulty in making or breaking vertically-oriented connections. When compartment access is from the bottom, vertically-oriented connections can allow fluid to leak onto the maintainer. When access is from the top, such connections can allow foreign matter to enter the line. Use horizontal penetrations whenever possible.
3.09.02	Pneumatic Systems and Pumps	ARM-05	All servicing and turnaround functions (including movement envelopes) should be outside the gun firing envelope.

Guidelines by Category (Cont'd)

Category No.	Category Title	Guideline No.	Guideline
3.09.02	Pneumatic Systems and Pumps	BIT-06	Mission critical functions should be monitored by BIT.
		BIT-09	Use concurrent BIT to monitor system critical functions.
		BIT-20	The BIT should be mechanized so that when a piece of equipment is not installed in a subsystem or the product, a failure will not be indicated.
		BIT-26	Locate routinely used test points so they are accessible without removing or disassembling other equipment
		CBR-01	Orient all vehicle liquid servicing fittings to ensure fluids will not come in contact with protective garb during connect/disconnect activities.
		CBR-02	Ensure vehicle overboard passive liquid drains are clearly marked or visible to enable personnel to remain clear of area.
		CBR-03	Design fuel cell drains so they can not be activated in a manner that would allow fuel to come in contact with a protected hand.
		ENG(G)-12	Provide a clear and viewable access envelope to fuel and oil filters.
		ENG(G)-13	Locate fuel filters to ensure no safety hazard will exist due to residual fuel during filter change.
		ENG(G)-18	Incorporate appropriate sensors to enhance the diagnostic and prognostic capabilities for the following: <ul style="list-style-type: none"> - Oil temperature - Oil pressure - Oil filter bypass - Oil cooler bypass valve position - Oil level - Oil return line particle count
		ENG(G)-20	Design all firewall fittings, connectors, and penetrations to be fully viewable and directly accessible to the maintainers.
		ENG-02	Each different component of rotating machinery should contain different tracer elements to enhance EEMS and IDM isolation and tracking of wear.
		ENG-04	The engine and engine-mounted gear box should have individual oil supplies to ensure wear or failures in one will not contaminate or fail the other.
		ENG-05	All engine-mounted air and fluid lines should be located next to the fan case, engine case, or full-length fan duct to ensure quick and simple replacement of accessories and components.
		ENG-06	All other engine surfaces and engine-mounted accessory surfaces should be free of pockets, channels, and bathtubs that could trap and retain fluids.
		ENG-10	On multi-engine air vehicles, the airframe-to-engine interfaces should be in identical positions or orientations for each engine cavity.
		ENG-13	Engine oil systems should contain on-board spectrometric oil analysis devices located on the engine.
		ENG-14	Coring of engine gear box cases and housings to provide for fuel heat sink routing should take precedence over dedicated fuel or oil heat exchangers.
		ENG-20	Do not locate equipment or components in the engine cavity except for those components associated with the engine or engine installation.
		ENG-21	Do not locate equipment or components in the engine bay cavity in a manner that would require removal or repositioning for engine removal.
		ENG-22	The engine cavity structure should be capable of withstanding a 2000-degree Fahrenheit fire for 10 minutes without jeopardizing loss of the vehicle.
		ENG-25	All engine-to-airframe plumbing, wiring, and duct interfaces should be capable of being connected or disconnected by hand, should contain integral safety provisions, and should not require torquing.
		ENG-37	Gravity type servicing fittings, covers, and caps should have integral locking features, openable by hand, and contain a cable or chain to prevent loss or dropping.
		ENG-45	Provide remote servicing points accessible from the ground to service engine accessories mounted on top of the engine (e.g., oil tanks, gear boxes, generators, etc.) to eliminate climbing upon or atop the host vehicle.
		ENG-49	Design engine fuel and oil filters with integral locking features so they can be installed and removed by hand, and require no torquing.

Guidelines by Category (Cont'd)

Category No.	Category Title	Guideline No.	Guideline
3.09.02	Pneumatic Systems and Pumps	ENG-50	Design engine fuel and oil filter delta pressure indicators so they can be reset only from within the filter housing.
		ENG-51	Provide engine fuel and oil filters with anti-surge protection to ensure false delta pressure indications do not occur.
		GBD-01	Guidelines for transmissions, clutches, and rotors apply.
		GBD-02	Use the host gear box lubricating system to provide lubrication of the drive shaft spline.
		GBD-03	Design drive shafts using the "blind spline" concept to ensure correct mating of the shaft to the gear box.
		GBD-04	Design drive shafts with a simple, light-weight cover to protect personnel.
		GBD-05	Design drive shaft covers with a hole or slot type opening to prevent the masking of leakage or damage.
		HYD-01	For military combat vehicles having two or more hydraulic power systems, provide a minimum 30-inch spacing between ground power and servicing interfaces to ensure: <ul style="list-style-type: none"> - Design flexibility in locating and arranging equipment in high-density vehicles such as fighters and helicopters, - Work area separation to enable concurrent service/maintenance on systems, - Systems vulnerability enhancement, - Reduction in turn-around elapsed time due to concurrent servicing capability.
		HYD-02	Use identical components, such as pumps, reservoirs, and accumulators, in each individual power subsystem. In instances where this is not fully possible, perform and document trade studies or appropriate analysis to provide justification and supporting rationale.
		HYD-03	Use identical types of fluid in all hydraulic subsystems. Brakes may be the exception only if the system is totally separated from the independent of other hydraulic systems.
		HYD-04	For vehicles containing two or more systems with different fluids, use different service fittings and different ground power interfaces for each fluid type.
		HYD-05	Design protective caps or covers over service fittings with steel cable lanyards to prevent loss and migration in the vehicle.
		HYD-06	Mount hydraulic pumps to the gear box flange with v-band clamps containing a torq-set or equivalent fastener.
		HYD-07	Modularize electric-driven hydraulic pumps to enable replacement of the drive motor without interruption of the fluid lines.
		HYD-08	Design hydraulic pumps and motors with tracer elements to detect wear through on-board spectrometric oil analysis devices.
		HYD-09	Provide hydraulic devices used in critical applications with integral 5 micron filtering.
		HYD-10	Design the fluid storage system so it can be serviced in one-quart increments to eliminate the effects of handling and storing partially-filled cans.
		HYD-11	Design flexible hose with molded-in color bands to clearly indicate when the maximum wear/abrasion has been reached.
		LG-01	Bearings, excluding wheel bearings, should not require lubrication during the expected life of the air vehicle airframe.
		LG-04	Do not use Beryllium and Beryllium base alloys in any location subject to wear or corrosive atmospheres or in installations where machining may be required.
		LG-12	All struts should contain a spare strut lower seal stowed in the strut collar to avoid removing the lower strut for leak repair.
		MC-01	All clamps should contain torque-set or torque-limiting connections to prevent clamp or component failure due to over-torque. Clamp installation call outs should not depend on special tools to establish the required torque values.
		MC-02	Avoid the use of cotter pins, safety wire, safety clips, and similar devices to prevent maintenance-induced events leading to ground vehicle accidents or loss of air vehicles.
		MC-03	All tubing connections and interfaces should use rosan/dynatube (or equivalent) to (1) enable connect or disconnect with one hand, one tool, (2) eliminate the need to safety the connection, (3) provide a superior seal, and (4) negate need to reposition line(s) during component replacement.
		MC-04	No trombone type, flared tube type, or piloted line type interfaces should be used to avoid the need for removal or repositioning during equipment removal.

Guidelines by Category (Cont'd)

Category No.	Category Title	Guideline No.	Guideline
3.09.02	Pneumatic Systems and Pumps		
		MC-05	Avoid potential foreign object traps during manufacturing or operational maintenance by eliminating vertical penetrations of plumbing/fittings into tanks, compartments, or cells
		MC-06	Locate, position, orient all plumbing and duct electrical connectors to prevent the need for sequential installation or removal.
		MC-07	Maximize areas of constant web thickness in firewalls, carry-through bulkheads, major frames, structural ribs, spars, webs, keels, and close-outs to provide flexibility in locating penetration fittings. Stepped chem milling, stepped machining, stepped composite layup concepts all tend to result in minimal available surface area for penetrations.
		MC-08	All in-line plumbing connections within a fuel tank or cell should be capable of making/breaking the interface by hand, require no torque, contain integral safety locking mechanisms, and should be void of any requirement for safety wire.
		MC-09	All plumbing connections and fittings used for fuel systems should contain integral bonding features to eliminate the need for bonding clamps or jumper cables.
		MC-10	In rare instances where a plumbing run contains complex form or geometry that would require removal of other plumbing or equipment for access, in-line connectors should be incorporated to maintain the integrity of other plumbing or equipment.
		MC-11	No subsystem plumbing, equipment, or wiring should use a tank, cell, or compartment containing liquids as a means for routing or penetration simplicity during manufacture.
		MC-12	All plumbing and connectors containing liquids should be meniscus-free.
		MC-13	In instances where plumbing or connector interfaces cannot or are not keyed for a specific orientation, all identification, markings, cautions, and directions should be placed 360 degrees around the tube or duct.
		MC-14	Where multiple connectors are located in close proximity, ensure (1) a minimum hand tool arc of 120 degrees can be maintained, and (2) stagger fittings to ensure firm coupling interface/hand tool interface can be accomplished without inducing damage to adjacent lines.
		P-01	Access door and panel fastener types for airborne vehicles should meet the following criteria: - use latches for a frequency of access of 0 to 40 flight hours - use High Strength Quick Release fasteners for a frequency of access of 40-400 flight hours - use structural screws for a frequency of access of 400 flight hours or more
		P-02	Access door and panel fastener types for surface vehicles should meet the following criteria: - use a spring loaded or latch fastener for an opening frequency of daily - use a one quarter turn fastener (or equivalent) for an opening frequency of weekly - use screws or bolts for all other cases
		P-03	All doors and panels subject to environmental elements should contain form-in-place seals (or equivalent) attached to the door structure, not substructure, to prevent damage during maintenance.
		P-04	Door and panel seals should be compatible with all types of on-board servicing fluids, de-ice and anti-ice fluids, and all fluids used for chemical, biological, and nuclear decontamination.
		P-05	Piano type hinges should not be used on doors or panels because they are subject to wear, corrosion, and sand and fluid entry.
		P-06	Access door and panel devices used to support door in opened position should meet the following criteria: - for airborne vehicles, design for 60 knot gust loads (or equivalent jet blast loads) - for ground vehicles, design for 50 mph gust loads
		P-07	Hinged access doors and panels capable of remaining in the opened position should not have sharp edges or corners.
		P-08	Removable access door and panel fasteners should be of identical grip length and diameter.
		P-09	Acceptable door and panel hold-open devices include over-center sheet metal spring, over-center spring link, spring cartridge, support strut, and pinned goose neck hinge.
		P-10	Access doors and panels requiring non-captive fasteners should not be located forward of air inlet ducts or high-energy rotating components (e.g., prop fans, engine cooling fans, etc.).
		P-11	Access doors and panels should be interchangeable as justified by operation and support costs or life cycle costs.
		SABCH-02	All flush type structural screws should have identical head drives for the entire vehicle.

Guidelines by Category (Cont'd)

Category No.	Category Title	Guideline No.	Guideline
3.09.02	Pneumatic Systems and Pumps	SABCH-03	All non-flush type structural screws should have identical head drive recesses for the entire vehicle.
		SABCH-04	Special high strength bolts, such as twelve-point heads, should be fully justified from standpoint of the cost of ownership and effectiveness.
		SABCH-05	Structural design should avoid the reliance on blind fasteners unless fully supported by cost, weight, schedule, and effectiveness analysis.
		SEAT-02	Design personnel seats and padding materials so they are incapable of absorbing and holding fluids.
		SI-03	Parts and assemblies of a given model product or of models of a product in the same series should be interchangeable or replaceable.
		TCR-01	For each transmission, clutch, or rotor, provide a dedicated lubricating oil supply tank and system that is not shared with any other oil lubricating system.
		TCR-02	Provide each dedicated oil supply system with a separate servicing port/interface, pressure gauging, and quantity gauging system as applicable.
		TCR-03	Use a singular gage capable of reading pressures or quantities from two or more lubricating systems in preference to individual gages.
		TCR-04	Provide each dedicated system with an on-board spectrometric oil analysis program capability, separate oil filter, and separate oil, fuel, or air heat exchanger capability.
		TCR-05	Use the item's self-contained oil system to provide drive/interface spline lubrication, if required.
		TCR-06	In complex units, use different tracer elements in multiple gears, plates, discs, etc., so the source of wear can be easily identified by spectrometric oil analysis monitoring units.
		WT&B-01	Wheel bearings should be lubricated by oil-bath concepts and should not be integral with the wheel assembly.
3.09.03	Hydraulic Systems, Tanks, Pumps, Accumulators, and Reservoirs	A-02	Equipment bay and compartment structure should be bonded, co-cured, welded, machined, or combinations thereof to eliminate or minimize the use of mechanical fasteners.
		A-03	All equipment bay and compartment structural flanges and stiffeners should be external to the compartment to maximize the volume available for equipment installation and arrangement.
		A-04	Use stiffening beads in lieu of flanges to the maximum extent to enhance compartment volume and simplify repairs.
		A-05	Stiffening beads should have the convex surface toward the compartment to eliminate fluid traps.
		A-05	Keep all machined compartment frames, webs, and closure panels to a constant thickness (e.g., not stepped or tapered) to ease simplicity of fluid or electrical penetrations and ease and simplicity of structural repair.
		A-08	Plumbing penetrations into a compartment should not be on a vertical axis due to difficulty in making or breaking vertically-oriented connections. When compartment access is from the bottom, vertically-oriented connections can allow fluid to leak onto the maintainer. When access is from the top, such connections can allow foreign matter to enter the line. Use horizontal penetrations whenever possible.
		ARM-05	All servicing and turnaround functions (including movement envelopes) should be outside the gun firing envelope.
		BIT-05	Incorporate testability design features as an integral part of equipment preliminary design process.
		BIT-06	Mission critical functions should be monitored by BIT.
		BIT-09	Use concurrent BIT to monitor system critical functions.
		BIT-20	The BIT should be mechanized so that when a piece of equipment is not installed in a subsystem or the product, a failure will not be indicated.
		BIT-26	Locate routinely used test points so they are accessible without removing or disassembling other equipment.
		D&V-01	The geometric aspects of structural design and interfaces should not result in any natural bathtubs.
		D&V-02	Closed structural sections subject to condensation or fluid migration should contain drainage provisions.
		D&V-03	Crew cabs, operators' compartments, crew stations, cockpits, and passenger compartments should be subject to the same corrosion prevention measures as the exteriors of the vehicles. Low points, pockets, and related fluid collection points within should be provided with low point drains.
		ENG(G)-06	The distance between the engine and firewall should ensure the access envelopes to lines, fittings, wiring, and adjustments will accommodate the 75 percentile male hand.
ENG(G)-10	Design attaching hardware for all mechanical engine-to-vehicle interfaces to be captive and with integral safeties.		

Guidelines by Category (Cont'd)

Category No.	Category Title	Guideline No.	Guideline
3.09.03	Hydraulic Systems, Tanks, Pumps, Accumulators, and Reservoirs	ENG(G)-18	Incorporate appropriate sensors to enhance the diagnostic and prognostic capabilities for the following: <ul style="list-style-type: none"> - Fuel filter bypass - Oil pressure - Coolant pressure - Oil filter bypass - Coolant level - Oil cooler bypass valve position - Coolant temperature - Oil level - Vibration pickups - Oil return line particle count - Chip detector
		ENG(G)-20	Design all firewall fittings, connectors, and penetrations to be fully viewable and directly accessible to the maintainers.
		ENG-02	Each different component of rotating machinery should contain different tracer elements to enhance EEMS and IDM isolation and tracking of wear.
		ENG-05	All engine-mounted air and fluid lines should be located next to the fan case, engine case, or full-length fan duct to ensure quick and simple replacement of accessories and components.
		ENG-20	Do not locate equipment or components in the engine cavity except for those components associated with the engine or engine installation.
		ENG-21	Do not locate equipment or components in the engine bay cavity in a manner that would require removal or repositioning for engine removal.
		ENG-22	The engine cavity structure should be capable of withstanding a 2000-degree Fahrenheit fire for 10 minutes without jeopardizing loss of the vehicle.
		ENG-25	All engine-to-airframe plumbing, wiring, and duct interfaces should be capable of being connected or disconnected by hand, should contain integral safety provisions, and should not require torquing.
		ENG-45	Provide remote servicing points accessible from the ground to service engine accessories mounted on top of the engine (e.g., oil tanks, gear boxes, generators, etc.) to eliminate climbing upon or atop the host vehicle.
		HYD-01	For military combat vehicles having two or more hydraulic power systems, provide a minimum 30-inch spacing between ground power and servicing interfaces to ensure: <ul style="list-style-type: none"> - Design flexibility in locating and arranging equipment in high-density vehicles such as fighters and helicopters, - Work area separation to enable concurrent service/maintenance on systems, - Systems vulnerability enhancement, - Reduction in turn-around elapsed time due to concurrent servicing capability.
		HYD-09	Provide hydraulic devices used in critical applications with integral 5 micron filtering.
		HYD-11	Design flexible hose with molded-in color bands to clearly indicate when the maximum wear/abrasion has been reached.
		MC-01	All clamps should contain torque-set or torque-limiting connections to prevent clamp or component failure due to over-torque. Clamp installation call outs should not depend on special tools to establish the required torque values.
		MC-02	Avoid the use of cotter pins, safety wire, safety clips, and similar devices to prevent maintenance-induced events leading to ground vehicle accidents or loss of air vehicles.
		MC-03	All tubing connections and interfaces should use rosan/dynatube (or equivalent) to (1) enable connect or disconnect with one hand, one tool, (2) eliminate the need to safety the connection, (3) provide a superior seal, and (4) negate need to reposition line(s) during component replacement.
		MC-04	No trombone type, flared tube type, or piloted line type interfaces should be used to avoid the need for removal or repositioning during equipment removal.
		MC-05	Avoid potential foreign object traps during manufacturing or operational maintenance by eliminating vertical penetrations of plumbing/fittings into tanks, compartments, or cells
		MC-06	Locate, position, orient all plumbing and duct electrical connectors to prevent the need for sequential installation or removal.
		MC-09	All plumbing connections and fittings used for fuel systems should contain integral bonding features to eliminate the need for bonding clamps or jumper cables.
		MC-10	In rare instances where a plumbing run contains complex form or geometry that would require removal of other plumbing or equipment for access, in-line connectors should be incorporated to maintain the integrity of other plumbing or equipment.

Guidelines by Category (Cont'd)

Category No.	Category Title	Guideline No.	Guideline
3.09.03	Hydraulic Systems, Tanks, Pumps, Accumulators, and Reservoirs	MC-11	No subsystem plumbing, equipment, or wiring should use a tank, cell, or compartment containing liquids as a means for routing or penetration simplicity during manufacture.
		MC-12	All plumbing and connectors containing liquids should be meniscus-free.
		MC-13	In instances where plumbing or connector interfaces cannot or are not keyed for a specific orientation, all identification, markings, cautions, and directions should be placed 360 degrees around the tube or duct.
		MC-14	Where multiple connectors are located in close proximity, ensure (1) a minimum hand tool arc of 120 degrees can be maintained, and (2) stagger fittings to ensure firm coupling interface/hand tool interface can be accomplished without inducing damage to adjacent lines.
		MP-01	Avoid the use of epoxies to mount parts on repairable modules because they make repair extremely difficult.
		MP-02	Use a unique identification (ID) resistor incorporated in each system module to verify that the proper module is mounted on ATE.
		MP-03	Design modules so that lengthy warm-up times, special coding and air purity levels, and similar constraints are not necessary.
		P-01	Access door and panel fastener types for airborne vehicles should meet the following criteria: <ul style="list-style-type: none"> - use latches for a frequency of access of 0 to 40 flight hours - use High Strength Quick Release fasteners for a frequency of access of 40-400 flight hours - use structural screws for a frequency of access of 400 flight hours or more
		P-02	Access door and panel fastener types for surface vehicles should meet the following criteria: <ul style="list-style-type: none"> - use a spring loaded or latch fastener for an opening frequency of daily - use a one quarter turn fastener (or equivalent) for an opening frequency of weekly - use screws or bolts for all other cases
		P-03	All doors and panels subject to environmental elements should contain form-in-place seals (or equivalent) attached to the door structure, not substructure, to prevent damage during maintenance.
		P-04	Door and panel seals should be compatible with all types of on-board servicing fluids, de-ice and anti-ice fluids, and all fluids used for chemical, biological, and nuclear decontamination.
		P-05	Piano type hinges should not be used on doors or panels because they are subject to wear, corrosion, and sand and fluid entry.
		P-06	Access door and panel devices used to support door in opened position should meet the following criteria: <ul style="list-style-type: none"> - for airborne vehicles, design for 60 knot gust loads (or equivalent jet blast loads) - for ground vehicles, design for 50 mph gust loads
		P-07	Hinged access doors and panels capable of remaining in the opened position should not have sharp edges or corners.
		P-08	Removable access door and panel fasteners should be of identical grip length and diameter.
		P-09	Acceptable door and panel hold-open devices include over-center sheet metal spring, over-center spring link, spring cartridge, support strut, and pinned goose neck hinge.
		P-10	Access doors and panels requiring non-captive fasteners should not be located forward of air inlet ducts or high-energy rotating components (e.g., prop fans, engine cooling fans, etc.).
		P-11	Access doors and panels should be interchangeable as justified by operation and support costs or life cycle costs.
		PYRO-42	In weapons carriage design and integration, avoid dependence of on-board high pressure nitrogen.
		SABCH-02	All flush type structural screws should have identical head drives for the entire vehicle.
		SABCH-03	All non-flush type structural screws should have identical head drive recesses for the entire vehicle.
		SABCH-04	Special high strength bolts, such as twelve-point heads, should be fully justified from standpoint of the cost of ownership and effectiveness.
		SABCH-05	Structural design should avoid the reliance on blind fasteners unless fully supported by cost, weight, schedule, and effectiveness analysis.
		SAFE-03	Stored energy devices (e.g., accumulators, nitrogen bottles, gas generators, etc.), that could cause injury, harm, or damage if inadvertently actuated, should contain integral safing provisions.

MIL-HDBK-470A

APPENDIX C

Guidelines by Category (Cont'd)

Category No.	Category Title	Guideline No.	Guideline
3.09.03	Hydraulic Systems, Tanks, Pumps, Accumulators, and Reservoirs	SLI-03	Parts and assemblies of a given model product or of models of a product in the same series should be interchangeable or replaceable.
3.10	Wheels and Related	A-10	Provide a sufficient number of compartment fluid drains to ensure fluid drainage for varying aircraft static attitudes and varying terrain slopes for ground vehicles.
		A-13	Two-sided or two-surfaced access should not be required for access to equipment interfaces and hardpoints. The term two-sided infers top/bottom, left/right, front/back, or combinations thereof.
		A-18	Use transparent windows, quick-opening covers, or openings without any cover to permit quick visual inspections where needed.
		ARM-03	Locate fuselage weapon bays a minimum of 18" from the nose landing gear and main landing gear of an aircraft.
		BIT-01	During design of the BIT, use worst-case stress analysis to ensure that any circuit failures induced by temperature extremes, tolerance build-up, power supply variations, and combinations thereof are identified.
		BIT-02	Ensure that BIT system thresholds are consistent with those across the system, subsystem, item, module, and piece-part levels to prevent excessive numbers of Cannot Duplicate (CND) and Retest OK (RTOK) events from occurring.
		BIT-03	The degree of BIT required or proposed should be based on the respective failure rates and the appropriate FMECA at all equipment indenture levels.
		BIT-04	Limit the amount of data that is recorded to a manageable size by: <ul style="list-style-type: none"> - Limiting the number of signals that are monitored - Limiting the maximum sampling rate - Reducing the time span over which data is accumulated - Restricting the type of data accumulated
		BIT-05	Incorporate testability design features as an integral part of equipment preliminary design process.
		BIT-06	Mission critical functions should be monitored by BIT.
		BIT-09	Use concurrent BIT to monitor system critical functions.
		BIT-16	Critical voltages should be visually monitored by sending the voltage signals to visible LEDs.
		BIT-20	The BIT should be mechanized so that when a piece of equipment is not installed in a subsystem or the product, a failure will not be indicated.
		BIT-26	Locate routinely used test points so they are accessible without removing or disassembling other equipment
		CONT-01	Control rods should use Boyd or impedance type bolts (or equivalent) to eliminate the need for cotter pins or safety wire.
		CONT-02	Do not use metal control cables for vehicles that will operate in salt water or salt air environments.
		CONT-03	Use control rods rather than control cables for non-complex applications and non-complex routing within the vehicle.
		CONT-04	Use control cables rather than control rods for most complex applications.
		CONT-05	Route cables so that 100 percent of a cable will be viewable for inspection.
		CONT-06	Design all pulleys and brackets associated with cable installations so they are accessible by a 75 percentile male hand.
		D&V-01	The geometric aspects of structural design and interfaces should not result in any natural bathtubs.
		D&V-02	Closed structural sections subject to condensation or fluid migration should contain drainage provisions.
		D&V-03	Crew cabs, operators' compartments, crew stations, cockpits, and passenger compartments should be subject to the same corrosion prevention measures as the exteriors of the vehicles. Low points, pockets, and related fluid collection points within should be provided with low point drains.
		ENV-04	For airborne and ground vehicles, the finishes should be durable against sand erosion throughout all surface wind speeds experienced in arid or desert geographical locations.
		HYD-09	Provide hydraulic devices used in critical applications with integral 5 micron filtering.
		HYD-11	Design flexible hose with molded-in color bands to clearly indicate when the maximum wear/abrasion has been reached.
		LG-01	Bearings, excluding wheel bearings, should not require lubrication during the expected life of the air vehicle airframe.
		LG-02	Hardpoints for attachment of landing gear trunnions should be capable of carrying all induced gear loads for the life of the airframe.

Guidelines by Category (Cont'd)

Category No.	Category Title	Guideline No.	Guideline
3.10	Wheels and Related	LG-03	Hardpoints for attachment for landing gear trunnions should not be machined as an integral part of the airframe structure when normal design sink rates over 25 feet per second are required.
		LG-04	Do not use Beryllium and Beryllium base alloys in any location subject to wear or corrosive atmospheres or in installations where machining may be required.
		LG-05	All bolts or similar threaded means used as adjustable stops should be positively retained in the adjusted reference without reliance on jam nuts, cotter pins, or safety wire.
		LG-06	Design struts, attachments, and interfaces so they do not depend on scheduled visual inspections, non-destructive inspection (NDI), or non-destructive test (NDT) to ensure the reliability or integrity of the system in the operational environment.
		LG-07	No portion of the landing gear struts, drag braces, or interfaces should contain pockets or bathtubs that can trap or hold moisture. In rare instances where this is not possible, holes should be drilled as appropriate to prevent moisture/liquid accumulation.
		LG-08	Brackets, levers, links, rods, et al mounted on the struts should either be symmetrical to tolerate reverse installation or should be impossible to reverse.
		LG-09	Use coiled tubing in lieu of flex lines or hoses for hydraulic line routing from the airframe to the strut.
		LG-10	All wiring or coax mounted to a strut should have appropriate interface connectors to simplify strut removal and installation.
		LG-11	All microswitches, proximity switches, lights, sensors, etc. mounted to a strut should have individual interface connectors. Wiring pigtails requiring in-line splices should be avoided.
		LG-13	No special tools or equipment should be required to maintain/service struts in normal day-to-day operational environments.
		LG-14	All interfaces from the airframe to the struts should be visible and accessible, and not require removal of airframe structure for access.
		LG-16	No portion of the landing gear rigging process should require support equipment type templates, gauges, or tools. Indexes, reference points, etc., should be an integral part of the landing gear/airframe design.
		LG-17	Hydraulic, pneumatic, or electrical actuators associated with landing gear systems should not require adjustment or rigging once installed in the air vehicle. Spare units should be rigged at the time of manufacture or overhaul.
		LG-18	Landing gear ground safety down locks should be an integral part of the overall design. Use or reliance on loose pins (support equipment) should be avoided.
		LG-20	Special locks and pins used solely for landing gear ground maintenance safety should be used only in those cases substantiated by cost effectiveness analysis.
		LG-21	Proximity type switches used in landing gear design should meet a minimum of 200 volt-amperes to eliminate Electromagnetic Interference (EMI) or Radiation Hazard (RADHAD) problems. Wiring associated with the landing gear design should meet the same requirements.
		LG-41	No more than 1 jack should be required to change any singular wheel/tire assembly.
		MC-01	All clamps should contain torque-set or torque-limiting connections to prevent clamp or component failure due to over-torque. Clamp installation call outs should not depend on special tools to establish the required torque values.
		MC-02	Avoid the use of cotter pins, safety wire, safety clips, and similar devices to prevent maintenance-induced events leading to ground vehicle accidents or loss of air vehicles.
		MC-03	All tubing connections and interfaces should use rosan/dynatube (or equivalent) to (1) enable connect or disconnect with one hand, one tool, (2) eliminate the need to safety the connection, (3) provide a superior seal, and (4) negate need to reposition line(s) during component replacement.
		MC-04	No trombone type, flared tube type, or piloted line type interfaces should be used to avoid the need for removal or repositioning during equipment removal.
		MC-13	In instances where plumbing or connector interfaces cannot or are not keyed for a specific orientation, all identification, markings, cautions, and directions should be placed 360 degrees around the tube or duct.

Guidelines by Category (Cont'd)

Category No.	Category Title	Guideline No.	Guideline
3.10	Wheels and Related	MC-14	Where multiple connectors are located in close proximity, ensure (1) a minimum hand tool arc of 120 degrees can be maintained, and (2) stagger fittings to ensure firm coupling interface/hand tool interface can be accomplished without inducing damage to adjacent lines.
		SE-01	Wheel chocks for all types of ground and airborne vehicles should contain the following features: <ul style="list-style-type: none"> - Be nestable for low volume during storage or transport - Be manufactured from corrosion-resistant materials - Be releasable from tire pinch - Be highly visible for day and night operations - Be impervious to all types of fluids used to service or maintain the vehicles - Be of light weight
		SE-02	Wheel chocks for airborne vehicles should also contain the following features: <ul style="list-style-type: none"> - Contain provisions for securing to ramp or flight decks - Contain provisions to secure chocks at wheels - Releasable/removable from outside of hot brake envelope - Contain provisions to enable chock to be used as a tire blowout device - Contain provisions to prevent skidding on snow or ice
		SE-03	Wheel chock design guideline discussion. Wheel chocks have historically contributed to numerous accidents and incidents across the entire design spectrum, yet have received the least design attention of any ground handling/support equipment. Directly and indirectly, poorly designed chocks have: <ul style="list-style-type: none"> - Resulted in numerous "jumping the chocks" incidents due to improper use or positioning, and improper chock sizing for the tire size/power application. Some instances result in destruction of the aircraft. - Resulted in vehicle movement/sliding across wet, snowy and icy surfaces as a result of improper grip. - Resulted in unwarranted tire damage and/or engine FOD. - Resulted in tertiary damage to other vehicles or ground equipment as a result of being blown about by jet/propeller blast. - Damaged surfaces due to temporary placement of chocks on vehicle surfaces during vehicle movement. - Resulted in personnel sliver/s abrasions (wooden chocks) and cuts (metal chocks) even when chocks were in decent useable condition. - Resulted in varied personnel ground accidents during attempts to use chocks as a temporary work stand.
		SI-03	Parts and assemblies of a given model product or of models of a product in the same series should be interchangeable or replaceable.
		WT&B-01	Wheel bearings should be lubricated by oil-bath concepts and should not be integral with the wheel assembly.
		WT&B-02	Brake-wear indicating pins should be highly visible during day and night operations.
		WT&B-03	Provide a parking brake capability to simplify wheel and tire replacements and to reduce operator fatigue during prolonged engine ground operations.
		WT&B-04	Tires should contain a color band to provide easy visual indication that maximum wear has been achieved.
		WT&B-05	Locking ring type concepts for retaining wheel halves should be given preference over multiple tie bolts.
		WT&B-06	Locate brake anti-skid system components, including brake control valves, for easy access in low-vibration environments.
		WT&B-07	Landing gear caution and warning systems should contain both initiated and periodic BIT and be capable of fault-isolating to each component in the system.
		WT&B-08	Do not use microswitches (mechanical) in gear caution and warning systems.
		WT&B-09	Brake clips, end plates, retainers, etc. used to build up wheel, tire, and brake assemblies should not be capable of reverse or improper installation.
		WT&B-10	No hubcaps or covers should be installed in a manner that prevents full visual viewing of the wheel retaining nut. In instances where this may not be possible, the design should ensure that the hubcap/cover cannot be installed unless the retaining nut is properly installed.

Guidelines by Category (Cont'd)

Category No.	Category Title	Guideline No.	Guideline
3.10	Wheels and Related	WT&B-11	Wheel axle nuts should contain integral retention devices or safetying features. In rare instances where this cannot be accomplished, a bolt and self-locking nut should be used. Locking rings and similar devices that can fail and cause FOD should be avoided.
		WT&B-12	A void the use of rivets to retain pressure pads, clips, brackets, and similar items in wheel/brake assemblies unless: - Rivet failure will not permit a part or item to fall into the brake disc/pad area, and - Exceptional quality control can be assured during manufacture of the part or rivet attachments, and - Frequent scheduled inspections will not be imposed to protect product integrity or reliability
		WT&B-13	Emergency brake handles should not be similar in shape or color as other handles nor should they be located in close proximity to such other handles.
		WT&B-14	Wheel assemblies should contain built-in dial type pressure gages.
		WT&B-15	Anti-skid and anti-lock brake systems should contain periodic and initiated BIT. All components, including speed sensors, comparators, wiring, connectors, control boxes, etc., should be included in the BIT system.
		WT&B-16	Do not use potting compounds for electrical connector environmental protection because it tends to revert and significantly increases repair time.
		WT&B-17	Electrical connector environmental protection should be capable of withstanding water pressure streams up to 120 psi encountered during decontamination, wash, etc.
		WT&B-18	Route brake lines so that line failure will not occur due to tire blow out or separation of recapped treads.
3.10.01	Tracks	A-05	Keep all machined compartment frames, webs, and closure panels to a constant thickness (e.g., not stepped or tapered) to ease simplicity of fluid or electrical penetrations and ease and simplicity of structural repair.
		A-15	Locate tie-down attachment points such that tie-down chains, straps, or cables do not prevent or restrict normal servicing, weapon loading, or safe/arm functions.
		BIT-05	Incorporate testability design features as an integral part of equipment preliminary design process.
		BIT-06	Mission critical functions should be monitored by BIT.
		BIT-09	Use concurrent BIT to monitor system critical functions.
		BIT-16	Critical voltages should be visually monitored by sending the voltage signals to visible LEDs.
		BIT-20	The BIT should be mechanized so that when a piece of equipment is not installed in a subsystem or the product, a failure will not be indicated.
		BIT-26	Locate routinely used test points so they are accessible without removing or disassembling other equipment
		CONT-01	Control rods should use Boyd or impedance type bolts (or equivalent) to eliminate the need for cotter pins or safety wire.
		CONT-02	Do not use metal control cables for vehicles that will operate in salt water or salt air environments.
		CONT-03	Use control rods rather than control cables for non-complex applications and non-complex routing within the vehicle.
		CONT-04	Use control cables rather than control rods for most complex applications.
		CONT-05	Route cables so that 100 percent of a cable will be viewable for inspection.
		CONT-06	Design all pulleys and brackets associated with cable installations so they are accessible by a 75 percentile male hand.
		ENV-04	For airborne and ground vehicles, the finishes should be durable against sand erosion throughout all surface wind speeds experienced in arid or desert geographical locations.
		ENV-06	For ground vehicles, the finishes should be compatible with and durable against all rain, hail, sleet, snow, and ice conditions experienced in all intended operational environments.
		HYD-09	Provide hydraulic devices used in critical applications with integral 5 micron filtering.
		LG-01	Bearings, excluding wheel bearings, should not require lubrication during the expected life of the air vehicle airframe.
		LG-02	Hardpoints for attachment of landing gear trunnions should be capable of carrying all induced gear loads for the life of the airframe.
		LG-03	Hardpoints for attachment for landing gear trunnions should not be machined as an integral part of the airframe structure when normal design sink rates over 25 feet per second are required.
		LG-04	Do not use Beryllium and Beryllium base alloys in any location subject to wear or corrosive atmospheres or in installations where machining may be required.

Guidelines by Category (Cont'd)

Category No.	Category Title	Guideline No.	Guideline
3.10.01	Tracks	LG-05	All bolts or similar threaded means used as adjustable stops should be positively retained in the adjusted reference without reliance on jam nuts, cotter pins, or safety wire.
		LG-06	Design struts, attachments, and interfaces so they do not depend on scheduled visual inspections, non-destructive inspection (NDI), or non-destructive test (NDT) to ensure the reliability or integrity of the system in the operational environment.
		LG-07	No portion of the landing gear struts, drag braces, or interfaces should contain pockets or bathtubs that can trap or hold moisture. In rare instances where this is not possible, holes should be drilled as appropriate to prevent moisture/liquid accumulation.
		LG-08	Brackets, levers, links, rods, et al mounted on the struts should either be symmetrical to tolerate reverse installation or should be impossible to reverse.
		LG-09	Use coiled tubing in lieu of flex lines or hoses for hydraulic line routing from the airframe to the strut.
		LG-10	All wiring or coax mounted to a strut should have appropriate interface connectors to simplify strut removal and installation.
		LG-11	All microswitches, proximity switches, lights, sensors, etc. mounted to a strut should have individual interface connectors.
		LG-13	Wiring pigtails requiring in-line splices should be avoided.
		LG-14	No special tools or equipment should be required to maintain/service struts in normal day-to-day operational environments.
		LG-15	All interfaces from the airframe to the struts should be visible and accessible, and not require removal of airframe structure for access.
		LG-16	No portion of the landing gear closure door(s) should be attached to the strut. In rare instances where this may not be possible, that attached portion should not require alignment or rigging.
		LG-17	No portion of the landing gear rigging process should require support equipment type templates, gauges, or tools. Indexes, reference points, etc., should be an integral part of the landing gear/airframe design.
		LG-30	Hydraulic, pneumatic, or electrical actuators associated with landing gear systems should not require adjustment or rigging once installed in the air vehicle. Spare units should be rigged at the time of manufacture or overhaul.
		LG-41	Do not use landing gear wells to locate any type of auxiliary air inlet.
		MC-01	No more than 1 jack should be required to change any singular wheel/tire assembly.
		MC-02	All clamps should contain torque-set or torque-limiting connections to prevent clamp or component failure due to over-torque. Clamp installation call outs should not depend on special tools to establish the required torque values.
		MC-03	Avoid the use of cotter pins, safety wire, safety clips, and similar devices to prevent maintenance-induced events leading to ground vehicle accidents or loss of air vehicles.
		MC-04	All tubing connections and interfaces should use rosan/dynatube (or equivalent) to (1) enable connect or disconnect with one hand, one tool, (2) eliminate the need to safety the connection, (3) provide a superior seal, and (4) negate need to reposition line(s) during component replacement.
		MC-12	No trombone type, flared tube type, or piloted line type interfaces should be used to avoid the need for removal or repositioning during equipment removal.
		MC-13	All plumbing and connectors containing liquids should be meniscus-free.
		MC-14	In instances where plumbing or connector interfaces cannot or are not keyed for a specific orientation, all identification, markings, cautions, and directions should be placed 360 degrees around the tube or duct.
			Where multiple connectors are located in close proximity, ensure (1) a minimum hand tool arc of 120 degrees can be maintained, and (2) stagger fittings to ensure firm coupling interface/hand tool interface can be accomplished without inducing damage to adjacent lines.

Guidelines by Category (Cont'd)

Category No.	Category Title	Guideline No.	Guideline
3.10.01	Tracks	SE-01	<p>Wheel chocks for all types of ground and airborne vehicles should contain the following features:</p> <ul style="list-style-type: none"> - Be nestable for low volume during storage or transport - Be manufactured from corrosion-resistant materials - Be releasable from tire pinch - Be highly visible for day and night operations - Be impervious to all types of fluids used to service or maintain the vehicles - Be of light weight
		SE-02	<p>Wheel chocks for airborne vehicles should also contain the following features:</p> <ul style="list-style-type: none"> - Contain provisions for securing to ramp or flight decks - Contain provisions to secure chocks at wheels - Releasable/removable from outside of hot brake envelope - Contain provisions to enable chock to be used as a tire blowout device - Contain provisions to prevent skidding on snow or ice
		SE-03	<p>Wheel chock design guideline discussion. Wheel chocks have historically contributed to numerous accidents and incidents across the entire design spectrum, yet have received the least design attention of any ground handling/support equipment. Directly and indirectly, poorly designed chocks have:</p> <ul style="list-style-type: none"> - Resulted in numerous "jumping the chocks" incidents due to improper use or positioning, and improper chock sizing for the tire size/power application. Some instances result in destruction of the aircraft. - Resulted in vehicle movement/sliding across wet, snowy and icy surfaces as a result of improper grip. - Resulted in unwarranted tire damage and/or engine FOD. - Resulted in tertiary damage to other vehicles or ground equipment as a result of being blown about by jet/propeller blast. - Damaged surfaces due to temporary placement of chocks on vehicle surfaces during vehicle movement. - Resulted in personnel sliver/s abrasions (wooden chocks) and cuts (metal chocks) even when chocks were in decent useable condition. - Resulted in varied personnel ground accidents during attempts to use chocks as a temporary work stand. - Lost aircraft "over the side" on carriers.
		SI-03	<p>Parts and assemblies of a given model product or of models of a product in the same series should be interchangeable or replaceable.</p>
		WT&B-01	<p>Wheel bearings should be lubricated by oil-bath concepts and should not be integral with the wheel assembly.</p>
		WT&B-02	<p>Brake-wear indicating pins should be highly visible during day and night operations.</p>
		WT&B-09	<p>Brake clips, end plates, retainers, etc. used to build up wheel, tire, and brake assemblies should not be capable of reverse or improper installation.</p>
		WT&B-11	<p>Wheel axle nuts should contain integral retention devices or safetying features. In rare instances where this cannot be accomplished, a bolt and self-locking nut should be used. Locking rings and similar devices that can fail and cause FOD should be avoided.</p>
		WT&B-12	<p>Avoid the use of rivets to retain pressure pads, clips, brackets, and similar items in wheel/brake assemblies unless:</p> <ul style="list-style-type: none"> - Rivet failure will not permit a part or item to fall into the brake disc/pad area, and - Exceptional quality control can be assured during manufacture of the part or rivet attachments, and - Frequent scheduled inspections will not be imposed to protect product integrity or reliability.
		WT&B-13	<p>Emergency brake handles should not be similar in shape or color as other handles nor should they be located in close proximity to such other handles.</p>
		WT&B-14	<p>Wheel assemblies should contain built-in dial type pressure gages.</p>
		WT&B-15	<p>Anti-skid and anti-lock brake systems should contain periodic and initiated BIT. All components, including speed sensors, comparators, wiring, connectors, control boxes, etc., should be included in the BIT system.</p>
		WT&B-16	<p>Do not use potting compounds for electrical connector environmental protection because it tends to revert and significantly increases repair time.</p>

MIL-HDBK-470A

APPENDIX C

Guidelines by Category (Cont'd)

Category No.	Category Title	Guideline No.	Guideline
3.10.01	Tracks	WT&B-17	Electrical connector environmental protection should be capable of withstanding water pressure streams up to 120 psi encountered during decontamination, wash, etc.
3.10.02	Wheels, Tires, and Brakes	WT&B-18	Route brake lines so that line failure will not occur due to tire blow out or separation of recapped treads.
		A-04	Use stiffening beads in lieu of flanges to the maximum extent to enhance compartment volume and simplify repairs. Stiffening beads should have the convex surface toward the compartment to eliminate fluid traps.
		A-15	Locate tie-down attachment points such that tie-down chains, straps, or cables do not prevent or restrict normal servicing, weapon loading, or safe/arm functions.
		ARM-03	Locate fuselage weapon bays a minimum of 18" from the nose landing gear and main landing gear of an aircraft.
		BIT-01	During design of the BIT, use worst-case stress analysis to ensure that any circuit failures induced by temperature extremes, tolerance build-up, power supply variations, and combinations thereof are identified.
		BIT-02	Ensure that BIT system thresholds are consistent with those across the system, subsystem, item, module, and piece-part levels to prevent excessive numbers of Cannot Duplicate (CND) and Retest OK (RTOK) events from occurring.
		BIT-03	The degree of BIT required or proposed should be based on the respective failure rates and the appropriate FMECA at all equipment indenture levels.
		BIT-04	Limit the amount of data that is recorded to a manageable size by: <ul style="list-style-type: none"> - Limiting the number of signals that are monitored - Limiting the maximum sampling rate - Reducing the time span over which data is accumulated - Restricting the type of data accumulated
		BIT-05	Incorporate testability design features as an integral part of equipment preliminary design process.
		BIT-06	Mission critical functions should be monitored by BIT.
		BIT-09	Use concurrent BIT to monitor system critical functions.
		BIT-16	Critical voltages should be visually monitored by sending the voltage signals to visible LEDs.
		BIT-20	The BIT should be mechanized so that when a piece of equipment is not installed in a subsystem or the product, a failure will not be indicated.
		BIT-26	Locate routinely used test points so they are accessible without removing or disassembling other equipment
		CONT-01	Control rods should use Boyd or impedance type bolts (or equivalent) to eliminate the need for cotter pins or safety wire.
		CONT-02	Do not use metal control cables for vehicles that will operate in salt water or salt air environments.
		CONT-03	Use control rods rather than control cables for non-complex applications and non-complex routing within the vehicle.
		CONT-04	Use control cables rather than control rods for most complex applications.
		CONT-05	Route cables so that 100 percent of a cable will be viewable for inspection.
		CONT-06	Design all pulleys and brackets associated with cable installations so they are accessible by a 75 percentile male hand.
		ENG(G)-20	Design all firewall fittings, connectors, and penetrations to be fully viewable and directly accessible to the maintainers.
		ENV-01	Materials, treatments, coatings, finishes should be compatible with all anti-ice and de-ice fluids, chemical and biological decontamination fluids, washing and cleaning fluids, and all vehicle subsystem fluids.
		ENV-02	There should be no top coat or treatment deterioration throughout the standard temperature and humidity spectrum.
		ENV-03	For airborne vehicles, the finishes should be durable against rain, hail, and dynamic erosion throughout the flight envelope.
		ENV-04	For airborne and ground vehicles, the finishes should be durable against sand erosion throughout all surface wind speeds experienced in arid or desert geographical locations.
		ENV-06	For ground vehicles, the finishes should be compatible with and durable against all rain, hail, sleet, snow, and ice conditions experienced in all intended operational environments.
		HYD-03	Use identical types of fluid in all hydraulic subsystems. Brakes may be the exception only if the system is totally separated from the independent of other hydraulic systems.
		HYD-09	Provide hydraulic devices used in critical applications with integral 5 micron filtering.
		HYD-11	Design flexible hose with molded-in color bands to clearly indicate when the maximum wear/abrasion has been reached.

MIL-HDBK-470A

APPENDIX C

Guidelines by Category (Cont'd)

Category No.	Category Title	Guideline No.	Guideline
3.10.02	Wheels, Tires, and Brakes	LG-01	Bearings, excluding wheel bearings, should not require lubrication during the expected life of the air vehicle airframe.
		LG-02	Hardpoints for attachment of landing gear trunnions should be capable of carrying all induced gear loads for the life of the airframe.
		LG-03	Hardpoints for attachment of landing gear trunnions should not be machined as an integral part of the airframe structure when normal design sink rates over 25 feet per second are required.
		LG-04	Do not use Beryllium and Beryllium base alloys in any location subject to wear or corrosive atmospheres or in installations where machining may be required.
		LG-05	All bolts or similar threaded means used as adjustable stops should be positively retained in the adjusted reference without reliance on jam nuts, cotter pins, or safety wire.
		LG-06	Design struts, attachments, and interfaces so they do not depend on scheduled visual inspections, non-destructive inspection (NDI), or non-destructive test (NDT) to ensure the reliability or integrity of the system in the operational environment.
		LG-07	No portion of the landing gear struts, drag braces, or interfaces should contain pockets or bathubs that can trap or hold moisture. In rare instances where this is not possible, holes should be drilled as appropriate to prevent moisture/liquid accumulation.
		LG-08	Brackets, levers, links, rods, et al mounted on the struts should either be symmetrical to tolerate reverse installation or should be impossible to reverse.
		LG-09	Use coiled tubing in lieu of flex lines or hoses for hydraulic line routing from the airframe to the strut.
		LG-10	All wiring or coax mounted to a strut should have appropriate interface connectors to simplify strut removal and installation.
		LG-11	All microswitches, proximity switches, lights, sensors, etc. mounted to a strut should have individual interface connectors. Wiring pigtailed requiring in-line splices should be avoided.
		LG-13	No special tools or equipment should be required to maintain/service struts in normal day-to-day operational environments.
		LG-14	All interfaces from the airframe to the struts should be visible and accessible, and not require removal of airframe structure for access.
		LG-15	No portion of the landing gear closure door(s) should be attached to the strut. In rare instances where this may not be possible, that attached portion should not require alignment or rigging.
		LG-16	No portion of the landing gear rigging process should require support equipment type templates, gauges, or tools. Indexes, reference points, etc., should be an integral part of the landing gear/airframe design.
		LG-17	Hydraulic, pneumatic, or electrical actuators associated with landing gear systems should not require adjustment or rigging once installed in the air vehicle. Spare units should be rigged at the time of manufacture or overhaul.
		LG-18	Landing gear ground safety down locks should be an integral part of the overall design. Use or reliance on loose pins (support equipment) should be avoided.
		LG-21	Proximity type switches used in landing gear design should meet a minimum of 200 volt-amperes to eliminate Electromagnetic Interference (EMI) or Radiation Hazard (RADHAD) problems. Wiring associated with the landing gear design should meet the same requirements.
		LG-30	Do not use landing gear wells to locate any type of auxiliary air inlet.
		LG-41	No more than 1 jack should be required to change any singular wheel/tire assembly.
MC-01	All clamps should contain torque-set or torque-limiting connections to prevent clamp or component failure due to over-torque. Clamp installation call outs should not depend on special tools to establish the required torque values.		
MC-02	Avoid the use of cotter pins, safety wire, safety clips, and similar devices to prevent maintenance-induced events leading to ground vehicle accidents or loss of air vehicles.		
MC-03	All tubing connections and interfaces should use rosan/dynatube (or equivalent) to (1) enable connect or disconnect with one hand, one tool, (2) eliminate the need to safety the connection, (3) provide a superior seal, and (4) negate need to reposition line(s) during component replacement.		

Guidelines by Category (Cont'd)

Category No.	Category Title	Guideline No.	Guideline
3.10.02	Wheels, Tires, and Brakes	MC-04	No trombone type, flared tube type, or piloted line type interfaces should be used to avoid the need for removal or repositioning during equipment removal.
		MC-09	All plumbing connections and fittings used for fuel systems should contain integral bonding features to eliminate the need for bonding clamps or jumper cables.
		MC-10	In rare instances where a plumbing run contains complex form or geometry that would require removal of other plumbing or equipment for access, in-line connectors should be incorporated to maintain the integrity of other plumbing or equipment.
		MC-11	No subsystem plumbing, equipment, or wiring should use a tank, cell, or compartment containing liquids as a means for routing or penetration simplicity during manufacture.
		MC-12	All plumbing and connectors containing liquids should be meniscus-free.
		MC-13	In instances where plumbing or connector interfaces cannot or are not keyed for a specific orientation, all identification, markings, cautions, and directions should be placed 360 degrees around the tube or duct.
		MC-14	Where multiple connectors are located in close proximity, ensure (1) a minimum hand tool arc of 120 degrees can be maintained, and (2) stagger fittings to ensure firm coupling interface/hand tool interface can be accomplished without inducing damage to adjacent lines.
		MP-01	Avoid the use of epoxies to mount parts on repairable modules because they make repair extremely difficult.
		MP-02	Use a unique identification (ID) resistor incorporated in each system module to verify that the proper module is mounted on ATE.
		MP-03	Design modules so that lengthy warm-up times, special coding and air purity levels, and similar constraints are not necessary.
		SABCH-21	Tire pressure reduction should not be required prior to tie down solely to increase the tire footprint
		SE-01	Wheel chocks for all types of ground and airborne vehicles should contain the following features: <ul style="list-style-type: none"> - Be nestable for low volume during storage or transport - Be manufactured from corrosion-resistant materials - Be releasable from tire pinch - Be highly visible for day and night operations - Be impervious to all types of fluids used to service or maintain the vehicles - Be of light weight
		SE-02	Wheel chocks for airborne vehicles should also contain the following features: <ul style="list-style-type: none"> - Contain provisions for securing to ramp or flight decks - Contain provisions to secure chocks at wheels - Releasable/removable from outside of hot brake envelope - Contain provisions to enable chock to be used as a tire blowout device - Contain provisions to prevent skidding on snow or ice
		SE-03	Wheel chock design guideline discussion. Wheel chocks have historically contributed to numerous accidents and incidents across the entire design spectrum, yet have received the least design attention of any ground handling/support equipment. Directly and indirectly, poorly designed chocks have: <ul style="list-style-type: none"> - Resulted in numerous "jumping the chocks" incidents due to improper use or positioning, and improper chock sizing for the tire size/power application. Some instances result in destruction of the aircraft. - Resulted in vehicle movement/sliding across wet, snowy and icy surfaces as a result of improper grip. - Resulted in unwarranted tire damage and/or engine FOD. - Resulted in tertiary damage to other vehicles or ground equipment as a result of being blown about by jet/propeller blast. - Damaged surfaces due to temporary placement of chocks on vehicle surfaces during vehicle movement. - Resulted in personnel sliver/s abrasions (wooden chocks) and cuts (metal chocks) even when chocks were in decent useable condition. - Resulted in varied personnel ground accidents during attempts to use chocks as a temporary work stand. - Lost aircraft "over the side" on carriers.

Guidelines by Category (Cont'd)

Category No.	Category Title	Guideline No.	Guideline
3.10.02	Wheels, Tires, and Brakes	SI-03	Parts and assemblies of a given model product or of models of a product in the same series should be interchangeable or replaceable.
		WT&B-01	Wheel bearings should be lubricated by oil-bath concepts and should not be integral with the wheel assembly.
		WT&B-02	Brake-wear indicating pins should be highly visible during day and night operations.
		WT&B-03	Provide a parking brake capability to simplify wheel and tire replacements and to reduce operator fatigue during prolonged engine ground operations.
		WT&B-04	Tires should contain a color band to provide easy visual indication that maximum wear has been achieved.
		WT&B-05	Locking ring type concepts for retaining wheel halves should be given preference over multiple tie bolts.
		WT&B-06	Locate brake anti-skid system components, including brake control valves, for easy access in low-vibration environments.
		WT&B-07	Landing gear caution and warning systems should contain both initiated and periodic BIT and be capable of fault-isolating to each component in the system.
		WT&B-08	Do not use microswitches (mechanical) in gear caution and warning systems.
		WT&B-09	Brake clips, end plates, retainers, etc. used to build up wheel, tire, and brake assemblies should not be capable of reverse or improper installation.
		WT&B-10	No hubcaps or covers should be installed in a manner that prevents full visual viewing of the wheel retaining nut. In instances where this may not be possible, the design should ensure that the hubcap/cover cannot be installed unless the retaining nut is properly installed.
		WT&B-11	Wheel axle nuts should contain integral retention devices or safetying features. In rare instances where this cannot be accomplished, a bolt and self-locking nut should be used. Locking rings and similar devices that can fail and cause FOD should be avoided.
		WT&B-12	Avoid the use of rivets to retain pressure pads, clips, brackets, and similar items in wheel/brake assemblies unless: <ul style="list-style-type: none"> - Rivet failure will not permit a part or item to fall into the brake disc/pad area, and - Exceptional quality control can be assured during manufacture of the part or rivet attachments, and - Frequent scheduled inspections will not be imposed to protect product integrity or reliability.
		WT&B-13	Emergency brake handles should not be similar in shape or color as other handles nor should they be located in close proximity to such other handles.
		WT&B-14	Wheel assemblies should contain built-in dial type pressure gages.
		WT&B-15	Anti-skid and anti-lock brake systems should contain periodic and initiated BIT. All components, including speed sensors, comparators, wiring, connectors, control boxes, etc., should be included in the BIT system.
		WT&B-16	Do not use potting compounds for electrical connector environmental protection because it tends to revert and significantly increases repair time.
		WT&B-17	Electrical connector environmental protection should be capable of withstanding water pressure streams up to 120 psi encountered during decontamination, wash, etc.
		WT&B-18	Route brake lines so that line failure will not occur due to tire blow out or separation of recapped treads.
		A-04	Use stiffening beads in lieu of flanges to the maximum extent to enhance compartment volume and simplify repairs.
		A-05	Stiffening beads should have the convex surface toward the compartment to eliminate fluid traps.
		A-06	Keep all machined compartment frames, webs, and closure panels to a constant thickness (e.g., not stepped or tapered) to ease simplicity of fluid or electrical penetrations and ease and simplicity of structural repair.
		A-15	Hardpoints (structural attachment and load bearing areas) within a compartment to assist in equipment mounting or support should not be integral with the machined part. Hardpoints should be parasitic to enable quick repair in case of wear or damage in lieu of precise ream/bush repair typical of machined hardpoints.
		ACS-01	Locate tie-down attachment points such that tie-down chains, straps, or cables do not prevent or restrict normal servicing, weapon loading, or safe/arm functions.
		ACS-02	Design air cushion skirt surfaces to be highly resistant to high velocity blowing sand and stones.
			Design skirt surfaces to the same operational and environmental criteria as that identified for low observable surfaces.
3.10.03	Landing Gear and Alighting Gear		

Guidelines by Category (Cont'd)

Category No.	Category Title	Guideline No.	Guideline
3.10.03	Landing Gear and Alighting Gear	ACS-03	Select materials for the skirt surface so that bonded repairs can be used for punctures and tears across a wide temperature spectrum/humidity index without relying on special facilities or equipment.
		ACS-04	Incorporate rip-stop methodology in skirt construction to limit tears and rips and to prevent tear propagation.
		ACS-05	Incorporate a color-coded interply in skirts to readily identify the maximum abrasion limit.
		ACS-06	Do not try to achieve high reliability by requiring frequent visual inspections or scheduled replacement at predetermined calendar or operating hour intervals.
		ACS-07	Design skirt repair kits and select materials for the kits so they are not subject to a predetermined shelf-life or special storage requirements.
		ACS-08	Design all elements making up the air cushion control system so they are capable of sustained operations in salt air/water environments.
		ACS-09	Employ control by wire or control by light technology to eliminate complex control mechanisms and associated maintenance and support.
		ARM-03	Locate fuselage weapon bays a minimum of 18" from the nose landing gear and main landing gear of an aircraft.
		ARM-08	Weapon and store ejectors containing arming solenoids should ensure the solenoids can be rapidly replaced while installed.
		BIT-01	During design of the BIT, use worst-case stress analysis to ensure that any circuit failures induced by temperature extremes, tolerance build-up, power supply variations, and combinations thereof are identified.
		BIT-02	Ensure that BIT system thresholds are consistent with those across the system, subsystem, item, module, and piece-part levels to prevent excessive numbers of Cannot Duplicate (CND) and Retest OK (RTOK) events from occurring.
		BIT-03	The degree of BIT required or proposed should be based on the respective failure rates and the appropriate FMECA at all equipment indenture levels.
		BIT-04	Limit the amount of data that is recorded to a manageable size by: <ul style="list-style-type: none"> - Limiting the number of signals that are monitored - Limiting the maximum sampling rate - Reducing the time span over which data is accumulated - Restricting the type of data accumulated
		BIT-05	Incorporate testability design features as an integral part of equipment preliminary design process.
		BIT-06	Mission critical functions should be monitored by BIT.
		BIT-09	Use concurrent BIT to monitor system critical functions.
		BIT-16	Critical voltages should be visually monitored by sending the voltage signals to visible LEDs.
		BIT-20	The BIT should be mechanized so that when a piece of equipment is not installed in a subsystem or the product, a failure will not be indicated.
		BIT-26	Locate routinely used test points so they are accessible without removing or disassembling other equipment
		CONT-01	Control rods should use Boyd or impedance type bolts (or equivalent) to eliminate the need for cotter pins or safety wire.
		CONT-02	Do not use metal control cables for vehicles that will operate in salt water or salt air environments.
		CONT-03	Use control rods rather than control cables for non-complex applications and non-complex routing within the vehicle.
		CONT-04	Use control cables rather than control rods for most complex applications.
		CONT-05	Route cables so that 100 percent of a cable will be viewable for inspection.
		CONT-06	Design all pulleys and brackets associated with cable installations so they are accessible by a 75 percentile male hand.
		D&V-01	The geometric aspects of structural design and interfaces should not result in any natural bathtubs.
		D&V-02	Closed structural sections subject to condensation or fluid migration should contain drainage provisions.
		D&V-03	Crew cabs, operators' compartments, crew stations, cockpits, and passenger compartments should be subject to the same corrosion prevention measures as the exteriors of the vehicles. Low points, pockets, and related fluid collection points within should be provided with low point drains.
		EC-15	The removal or replacement of electronic equipment should not require the removal of any other piece of equipment or armament.

MIL-HDBK-470A

APPENDIX C

Guidelines by Category (Cont'd)

Category No.	Category Title	Guideline No.	Guideline
3.10.03	Landing Gear and Alighting Gear	ENG-16	Aircraft jacking should not be required for engine removal.
		ENV-01	Materials, treatments, coatings, finishes should be compatible with all anti-ice and de-ice fluids, chemical and biological decontamination fluids, washing and cleaning fluids, and all vehicle subsystem fluids.
		ENV-02	There should be no top coat or treatment deterioration throughout the standard temperature and humidity spectrum.
		ENV-03	For airborne vehicles, the finishes should be durable against rain, hail, and dynamic erosion throughout the flight envelope.
		ENV-04	For airborne and ground vehicles, the finishes should be durable against sand erosion throughout all surface wind speeds experienced in arid or desert geographical locations.
		HOOK-01	Locate, orient, and mechanize Nose Gear Tow/Nose Gear Holdback (NGT/NGH) mechanisms so they do not interfere with the hookup and attachment of standard towbars.
		HOOK-02	Design NGT/NGH mechanisms with integral provisions to visually indicate correct hookup/attachment. The indication must be visible during all day and night carrier operations.
		HOOK-03	NGT/NGH mechanisms should not require scheduled visual or NDI type inspections.
		HOOK-04	Design tail hook points to be interchangeable and easily replaceable.
		HOOK-05	Design tail hook points so they can not be incorrectly installed.
		HOOK-06	Avoid the need to remove the tail hook to facilitate engine access or removal.
		HYD-09	Provide hydraulic devices used in critical applications with integral 5 micron filtering.
		HYD-11	Design flexible hose with molded-in color bands to clearly indicate when the maximum wear/abrasion has been reached.
		LG-01	Bearings, excluding wheel bearings, should not require lubrication during the expected life of the air vehicle airframe.
LG-02	Hardpoints for attachment of landing gear trunnions should be capable of carrying all induced gear loads for the life of the airframe.		
LG-03	Hardpoints for attachment for landing gear trunnions should not be machined as an integral part of the airframe structure when normal design sink rates over 25 feet per second are required.		
LG-04	Do not use Beryllium and Beryllium base alloys in any location subject to wear or corrosive atmospheres or in installations where machining may be required.		
LG-05	All bolts or similar threaded means used as adjustable stops should be positively retained in the adjusted reference without reliance on jam nuts, cotter pins, or safety wire.		
LG-06	Design struts, attachments, and interfaces so they do not depend on scheduled visual inspections, non-destructive inspection (NDI), or non-destructive test (NDT) to ensure the reliability or integrity of the system in the operational environment.		
LG-07	No portion of the landing gear struts, drag braces, or interfaces should contain pockets or bathtubs that can trap or hold moisture. In rare instances where this is not possible, holes should be drilled as appropriate to prevent moisture/liquid accumulation.		
LG-08	Brackets, levers, links, rods, et al mounted on the struts should either be symmetrical to tolerate reverse installation or should be impossible to reverse.		
LG-09	Use coiled tubing in lieu of flex lines or hoses for hydraulic line routing from the airframe to the strut.		
LG-10	All wiring or coax mounted to a strut should have appropriate interface connectors to simplify strut removal and installation.		
LG-11	All microswitches, proximity switches, lights, sensors, etc. mounted to a strut should have individual interface connectors. Wiring pigtailed requiring in-line splices should be avoided.		
LG-12	All struts should contain a spare strut lower seal stowed in the strut collar to avoid removing the lower strut for leak repair.		
LG-13	No special tools or equipment should be required to maintain/service struts in normal day-to-day operational environments.		
LG-14	All interfaces from the airframe to the struts should be visible and accessible, and not require removal of airframe structure for access.		

MIL-HDBK-470A

APPENDIX C

Guidelines by Category (Cont'd)

Category No.	Category Title	Guideline No.	Guideline
3.10.03	Landing Gear and Alighting Gear	LG-15	No portion of the landing gear closure door(s) should be attached to the strut. In rare instances where this may not be possible, that attached portion should not require alignment or rigging.
		LG-16	No portion of the landing gear rigging process should require support equipment type templates, gauges, or tools. Indexes, reference points, etc., should be an integral part of the landing gear/airframe design.
		LG-17	Hydraulic, pneumatic, or electrical actuators associated with landing gear systems should not require adjustment or rigging once installed in the air vehicle. Spare units should be rigged at the time of manufacture or overhaul.
		LG-18	Landing gear ground safety down locks should be an integral part of the overall design. Use or reliance on loose pins (support equipment) should be avoided.
		LG-19	When deemed necessary for the respective design, pilots, flight crews, or operators should have an indication of the downlock status in the cockpit or crew station to avoid the necessity of a flight abort.
		LG-20	Special locks and pins used solely for landing gear ground maintenance safety should be used only in those cases substantiated by cost effectiveness analysis.
		LG-21	Proximity type switches used in landing gear design should meet a minimum of 200 volt-amperes to eliminate Electromagnetic Interference (EMI) or Radiation Hazard (RADHAD) problems. Wiring associated with the landing gear design should meet the same requirements.
		LG-23	Design strut fittings for servicing nitrogen or hydraulic fluid to be easily accessible and adjacent to the appropriate strut pressure gage.
		LG-24	Design struts so they can be serviced with clean, dry air in lieu of nitrogen during deployments without affecting the overall reliability.
		LG-25	Mechanical shrink struts, when used, should not permit gear to jam in wheel well if failure of shrink mechanism occurs.
		LG-26	Gravitational emergency extension of landing gear should be given preference over all other concepts.
		LG-27	Downlocks should be over-center mechanical type and should not depend on hydraulic pressure to maintain the lock.
		LG-28	Landing gear control handle should have only "up" or "down" detents with no neutral or intermediate positions.
		LG-29	Basic gear design combined with manufacturing tolerances should ensure that no uplock or downlock rigging is required.
		LG-30	Do not use landing gear wells to locate any type of auxiliary air inlet.
		LG-31	Landing gear doors designed to close after gear is extended should be capable of being manually opened on the ground without reliance on electrical or hydraulic power.
		LG-32	Design of landing gear doors normally closed after gear extension should ensure failure modes will not enable uncommanded opening on the ground.
		LG-33	Design of landing gear doors normally left open after gear extension should ensure no failure mode will enable closing on the ground.
		LG-34	Avoid sharp edges and corners on landing gear doors or fairings.
		LG-35	Avoid the use of landing gear doors to mount or house antennas, arrays, or air data sensors.
		LG-41	No more than 1 jack should be required to change any singular wheel/tire assembly.
		LG-42	Landing gear struts should contain built-in, dial type pressure gages.
		LG-43	Incorporate low pressure warning sensors in nose landing gear whenever under-servicing of the gear could result in failure to rotate aircraft during takeoff. This feature will eliminate many aborted take-offs, many of which result in blown tires or aircraft leaving the runway.
		LG-44	Landing gear door mechanisms and interfaces should ensure that multiple cycles or occasional exceedence of maximum gear-down speed do not result in loss of doors
		MATL-02	Cosmetic type repairs should not exceed 1 hours including cure or drying times.
		MATL-03	Cosmetic and vehicle repair material shelf life should not be less than 24 months.
		MATL-04	Cosmetic and vehicle repair materials should be non-proprietary and non-single source.
		MATL-05	Cosmetic and vehicle repair materials should not require refrigeration or special facilities or atmospheres for storage.
		MATL-06	Repair criteria, repairs, and instructions should not be classified.
		MATL-07	All cosmetic touch-up and repair materials should be environmentally safe.

Guidelines by Category (Cont'd)

Category No.	Category Title	Guideline No.	Guideline
3.10.03	Landing Gear and Alighting Gear	MATL-08	Repairs (other than major depot repair) should not require autoclave type facilities.
		MATL-09	A high degree of durability should be achieved across all walkway areas on the top surfaces of all vehicles up to and including 95 percentile personnel.
		MATL-10	Coatings and finishes should be durable against the effects of missile gases, velocities, and particles emanating from the missile motor.
		MATL-11	Coatings and finishes should be durable against the effects of gun gases, projectile shock waves, and brass particles emanating from the projectile seal rings.
		MATL-13	Special handling or shipping requirements of repair materials should be avoided.
		MATL-15	Doors and panels containing blade seals used for signature reduction should be interchangeable or contain interchangeable blade seals. Deviation is acceptable where repairs can be accomplished on the vehicle in a time equal to or less than door or seal remove and replace time.
		MC-01	All clamps should contain torque-set or torque-limiting connections to prevent clamp or component failure due to over-torque. Clamp installation call outs should not depend on special tools to establish the required torque values.
		MC-02	Avoid the use of cotter pins, safety wire, safety clips, and similar devices to prevent maintenance-induced events leading to ground vehicle accidents or loss of air vehicles.
		MC-03	All tubing connections and interfaces should use rosan/dynatube (or equivalent) to (1) enable connect or disconnect with one hand, one tool, (2) eliminate the need to safety the connection, (3) provide a superior seal, and (4) negate need to reposition line(s) during component replacement.
		MC-04	No trombone type, flared tube type, or piloted line type interfaces should be used to avoid the need for removal or repositioning during equipment removal.
		MC-06	Locate, position, orient all plumbing and duct electrical connectors to prevent the need for sequential installation or removal.
		MC-09	All plumbing connections and fittings used for fuel systems should contain integral bonding features to eliminate the need for bonding clamps or jumper cables.
		MC-10	In rare instances where a plumbing run contains complex form or geometry that would require removal of other plumbing or equipment for access, in-line connectors should be incorporated to maintain the integrity of other plumbing or equipment.
		MC-11	No subsystem plumbing, equipment, or wiring should use a tank, cell, or compartment containing liquids as a means for routing or penetration simplicity during manufacture.
MC-12	All plumbing and connectors containing liquids should be meniscus-free.		
MC-13	In instances where plumbing or connector interfaces cannot or are not keyed for a specific orientation, all identification, markings, cautions, and directions should be placed 360 degrees around the tube or duct.		
MC-14	Where multiple connectors are located in close proximity, ensure (1) a minimum hand tool arc of 120 degrees can be maintained, and (2) stagger fittings to ensure firm coupling interface/hand tool interface can be accomplished without inducing damage to adjacent lines.		
MP-01	Avoid the use epoxies to mount parts on repairable modules because they make repair extremely difficult.		
MP-02	Use a unique identification (ID) resistor incorporated in each system module to verify that the proper module is mounted on ATE.		
MP-03	Design modules so that lengthy warm-up times, special coding and air purity levels, and similar constraints are not necessary.		
P-01	Access door and panel fastener types for airborne vehicles should meet the following criteria: <ul style="list-style-type: none"> - use latches for a frequency of access of 0 to 40 flight hours - use High Strength Quick Release fasteners for a frequency of access of 40-400 flight hours - use structural screws for a frequency of access of 400 flight hours or more 		
P-02	Access door and panel fastener types for surface vehicles should meet the following criteria: <ul style="list-style-type: none"> - use a spring loaded or latch fastener for an opening frequency of daily - use a one quarter turn fastener (or equivalent) for a opening frequency of weekly - use screws or bolts for all other cases 		

Guidelines by Category (Cont'd)

Category No.	Category Title	Guideline No.	Guideline
3.10.03	Landing Gear and Alighting Gear	P-03	All doors and panels subject to environmental elements should contain form-in-place seals (or equivalent) attached to the door structure, not substructure, to prevent damage during maintenance.
		P-04	Door and panel seals should be compatible with all types of on-board servicing fluids, de-ice and anti-ice fluids, and all fluids used for chemical, biological, and nuclear decontamination.
		P-05	Piano type hinges should not be used on doors or panels because they are subject to wear, corrosion, and sand and fluid entry.
		P-06	Access door and panel devices used to support door in opened position should meet the following criteria: <ul style="list-style-type: none"> - for airborne vehicles, design for 60 knot gust loads (or equivalent jet blast loads) - for ground vehicles, design for 50 mph gust loads
		P-07	Hinged access doors and panels capable of remaining in the opened position should not have sharp edges or corners.
		P-08	Removable access door and panel fasteners should be of identical grip length and diameter.
		P-09	Acceptable door and panel hold-open devices include over-center sheet metal spring, over-center spring link, spring cartridge, support strut, and pinned goose neck hinge.
		P-10	Access doors and panels requiring non-captive fasteners should not be located forward of air inlet ducts or high-energy rotating components (e.g., prop fans, engine cooling fans, etc.).
		P-11	Access doors and panels should be interchangeable as justified by operation and support costs or life cycle costs.
		SABCH-02	All flush type structural screws should have identical head drives for the entire vehicle.
		SABCH-03	All non-flush type structural screws should have identical head drive recesses for the entire vehicle.
		SABCH-04	Special high strength bolts, such as twelve-point heads, should be fully justified from standpoint of the cost of ownership and effectiveness.
		SABCH-05	Structural design should avoid the reliance on blind fasteners unless fully supported by cost, weight, schedule, and effectiveness analysis.
		SABCH-11	In rare instances where the use of dissimilar material in immediate contact cannot be avoided, they should be sufficiently insulated to endure for the life of the vehicle.
		SABCH-12	Avoid tapping threads into structural members. Use of heli-coil type or similar insert concepts is permissible.
		SABCH-13	No structural design concept should rely on frequent scheduled inspections to monitor or otherwise ensure structural integrity.
		SABCH-14	No structural fastener intended to carry shear or tension loads should be smaller than 1/4" diameter (.25").
		SABCH-15	Give preference to butt type splices over lap type splices in the design of manufacturing splices.
		SABCH-16	Wing-to-fuselage attachment should give preference to tension ties over shear ties to improve overall volumetric efficiency.
		SABCH-17	Hardpoints for securing tie down chains, cables, and devices during transport should not require reaching under or crawling under the vehicle.
		SABCH-18	Rings, posts, and clevis devices used for attaching tie downs should not require opening of doors or panels for access.
		SABCH-19	Avoid tie down concepts requiring attaching hardpoints as a prerequisite.
		SABCH-20	Location of hardpoints used for tie down attachment should: <ul style="list-style-type: none"> - Remain outside of door and panel opening envelopes. - Be clear of exhaust pipes, ducts, manifolds, and mufflers. - Be clear of overboard fluid drains and vents.
		SAFE-07	Landing and alighting gear design should ensure downlocks are integral to the mechanisms and provide a clear indication of position status. This guideline also applies to tail hooks.
		SAFE-11	All individual safety pins used for ground maintenance should be clearly visible and coupled together to ensure no single pin will be overlooked during arming.

Guidelines by Category (Cont'd)

Category No.	Category Title	Guideline No.	Guideline
3.10.03	Landing Gear and Alighting Gear	SE-01	<p>Wheel chocks for all types of ground and airborne vehicles should contain the following features:</p> <ul style="list-style-type: none"> - Be nestable for low volume during storage or transport - Be manufactured from corrosion-resistant materials - Be releasable from tire pinch - Be highly visible for day and night operations - Be impervious to all types of fluids used to service or maintain the vehicles - Be of light weight <p>Wheel chocks for airborne vehicles should also contain the following features:</p> <ul style="list-style-type: none"> - Contain provisions for securing to ramp or flight decks - Contain provisions to secure chocks at wheels - Releasable/removable from outside of hot brake envelope - Contain provisions to enable chock to be used as a tire blowout device - Contain provisions to prevent skidding on snow or ice <p>Wheel chock design guideline discussion. Wheel chocks have historically contributed to numerous accidents and incidents across the entire design spectrum, yet have received the least design attention of any ground handling/support equipment. Directly and indirectly, poorly designed chocks have:</p> <ul style="list-style-type: none"> - Resulted in numerous "jumping the chocks" incidents due to improper use or positioning, and improper chock sizing for the tire size/power application. Some instances result in destruction of the aircraft. - Resulted in vehicle movement/sliding across wet, snowy and icy surfaces as a result of improper grip. - Resulted in unwarranted tire damage and/or engine FOD. - Resulted in tertiary damage to other vehicles or ground equipment as a result of being blown about by jet/propeller blast. - Damaged surfaces due to temporary placement of chocks on vehicle surfaces during vehicle movement. - Resulted in personnel sliver/s abrasions (wooden chocks) and cuts (metal chocks) even when chocks were in decent useable condition. - Resulted in varied personnel ground accidents during attempts to use chocks as a temporary work stand. - Lost aircraft "over the side" on carriers. <p>Parts and assemblies of a given model product or of models of a product in the same series should be interchangeable or replaceable.</p> <p>Landing and taxi lights should be mounted on landing gear struts or doors to eliminate separate compartments, doors, and retraction/extension mechanisms.</p> <p>Design non-metallic floats to be impervious to all fluids used on board the host vehicle.</p> <p>Design non-metallic floats to be highly resistant to scuffing and abrasion.</p> <p>Design non-metallic floats with a color-coded inner ply to readily denote when maximum abrasion limits have been reached.</p> <p>Design pneumatic floats with an integral air gauge located adjacent to the air fill fitting.</p> <p>Design metallic and composite floats and skids to the same environmental criteria as the airframe, including finishes.</p> <p>Use non-skid finishes on the upper surfaces of skids and floats for use as steps and walkways.</p> <p>Design floats with simple drain provisions for each compartment.</p> <p>Do not locate windows in the proximity of rooster tails created by wheels/tires passing through water or slush.</p> <p>Wheel bearings should be lubricated by oil-bath concepts and should not be integral with the wheel assembly.</p> <p>Brake-wear indicating pins should be highly visible during day and night operations.</p> <p>Provide a parking brake capability to simplify wheel and tire replacements and to reduce operator fatigue during prolonged engine ground operations.</p> <p>Tires should contain a color band to provide easy visual indication that maximum wear has been achieved.</p> <p>Locking ring type concepts for retaining wheel halves should be given preference over multiple tie bolts.</p> <p>Locate brake anti-skid system components, including brake control valves, for easy access in low-vibration environments.</p>
		SE-02	
		SE-03	
		SI-03	
		SIMP-02	
		SKID-01	
		SKID-02	
		SKID-03	
		SKID-04	
		SKID-05	
		SKID-06	
		SKID-07	
		WIND-06	
		WT&B-01	
		WT&B-02	
		WT&B-03	
		WT&B-04	
		WT&B-05	
		WT&B-06	

Guidelines by Category (Cont'd)

Category No.	Category Title	Guideline No.	Guideline
3.10.03	Landing Gear and Alighting Gear	WT&B-07	Landing gear caution and warning systems should contain both initiated and periodic BIT and be capable of fault-isolating to each component in the system.
		WT&B-08	Do not use microswitches (mechanical) in gear caution and warning systems.
		WT&B-09	Brake clips, end plates, retainers, etc. used to build up wheel, tire, and brake assemblies should not be capable of reverse or improper installation.
		WT&B-10	No hubcaps or covers should be installed in a manner that prevents full visual viewing of the wheel retaining nut. In instances where this may not be possible, the design should ensure that the hubcap/cover cannot be installed unless the retaining nut is properly installed.
		WT&B-16	Do not use potting compounds for electrical connector environmental protection because it tends to revert and significantly increases repair time.
		WT&B-17	Electrical connector environmental protection should be capable of withstanding water pressure streams up to 120 psi encountered during decontamination, wash, etc.
		WT&B-18	Route brake lines so that line failure will not occur due to tire blow out or separation of recapped treads.
		A-04	Use stiffening beads in lieu of flanges to the maximum extent to enhance compartment volume and simplify repairs.
		A-05	Stiffening beads should have the convex surface toward the compartment to eliminate fluid traps.
		A-06	Keep all machined compartment frames, webs, and closure panels to a constant thickness (e.g., not stepped or tapered) to ease simplicity of fluid or electrical penetrations and ease and simplicity of structural repair.
		A-15	Hardpoints (structural attachment and load bearing areas) within a compartment to assist in equipment mounting or support should not be integral with the machined part. Hardpoints should be parasitic to enable quick repair in case of wear or damage in lieu of precise ream/bush repair typical of machined hardpoints.
		A-16	Locate tie-down attachment points such that tie-down chains, straps, or cables do not prevent or restrict normal servicing, weapon loading, or safe/arm functions.
		A-18	Structural design should provide good access to corrosion-prone areas for inspection and treatment.
		BIT-01	Use transparent windows, quick-opening covers, or openings without any cover to permit quick visual inspections where needed.
		BIT-02	During design of the BIT, use worst-case stress analysis to ensure that any circuit failures induced by temperature extremes, tolerance build-up, power supply variations, and combinations thereof are identified.
		BIT-03	Ensure that BIT system thresholds are consistent with those across the system, subsystem, item, module, and piece-part levels to prevent excessive numbers of Cannot Duplicate (CND) and Retest OK (RTOK) events from occurring.
		BIT-04	The degree of BIT required or proposed should be based on the respective failure rates and the appropriate FMECA at all equipment indenture levels.
		BIT-05	Limit the amount of data that is recorded to a manageable size by:
		BIT-06	- Limiting the number of signals that are monitored
		BIT-09	- Limiting the maximum sampling rate
		BIT-20	- Reducing the time span over which data is accumulated
		BIT-26	- Restricting the type of data accumulated
		CONT-01	Incorporate testability design features as an integral part of equipment preliminary design process.
		D&V-01	Mission critical functions should be monitored by BIT.
		D&V-02	Use concurrent BIT to monitor system critical functions.
			Critical voltages should be visually monitored by sending the voltage signals to visible LEDs.
			The BIT should be mechanized so that when a piece of equipment is not installed in a subsystem or the product, a failure will not be indicated.
			Locate routinely used test points so they are accessible without removing or disassembling other equipment
			Control rods should use Boyd or impedance type bolts (or equivalent) to eliminate the need for cotter pins or safety wire.
			The geometric aspects of structural design and interfaces should not result in any natural bathtubs.
			Closed structural sections subject to condensation or fluid migration should contain drainage provisions.

Guidelines by Category (Cont'd)

Category No.	Category Title	Guideline No.	Guideline
3.10.04	Skids and Floats	D&V-03	Crew cabs, operators' compartments, crew stations, cockpits, and passenger compartments should be subject to the same corrosion prevention measures as the exteriors of the vehicles. Low points, pockets, and related fluid collection points within should be provided with low point drains.
		EC-15	The removal or replacement of electronic equipment should not require the removal of any other piece of equipment or armament.
		ENV-01	Materials, treatments, coatings, finishes should be compatible with all anti-ice and de-ice fluids, chemical and biological decontamination fluids, washing and cleaning fluids, and all vehicle subsystem fluids.
		ENV-02	There should be no top coat or treatment deterioration throughout the standard temperature and humidity spectrum.
		ENV-03	For airborne vehicles, the finishes should be durable against rain, hail, and dynamic erosion throughout the flight envelope.
		ENV-04	For airborne and ground vehicles, the finishes should be durable against sand erosion throughout all surface wind speeds experienced in arid or desert geographical locations.
		ENV-06	For ground vehicles, the finishes should be compatible with and durable against all rain, hail, sleet, snow, and ice conditions experienced in all intended operational environments.
		HYD-09	Provide hydraulic devices used in critical applications with integral 5 micron filtering.
		LG-01	Bearings, excluding wheel bearings, should not require lubrication during the expected life of the air vehicle airframe.
		LG-02	Hardpoints for attachment of landing gear trunnions should be capable of carrying all induced gear loads for the life of the airframe.
		LG-03	Hardpoints for attachment for landing gear trunnions should not be machined as an integral part of the airframe structure when normal design sink rates over 25 feet per second are required.
		LG-04	Do not use Beryllium and Beryllium base alloys in any location subject to wear or corrosive atmospheres or in installations where machining may be required.
		LG-05	All bolts or similar threaded means used as adjustable stops should be positively retained in the adjusted reference without reliance on jam nuts, cotter pins, or safety wire.
		LG-06	Design struts, attachments, and interfaces so they do not depend on scheduled visual inspections, non-destructive inspection (NDI), or non-destructive test (NDT) to ensure the reliability or integrity of the system in the operational environment.
		LG-07	No portion of the landing gear struts, drag braces, or interfaces should contain pockets or bathubs that can trap or hold moisture. In rare instances where this is not possible, holes should be drilled as appropriate to prevent moisture/liquid accumulation.
		LG-08	Brackets, levers, links, rods, et al mounted on the struts should either be symmetrical to tolerate reverse installation or should be impossible to reverse.
		LG-09	Use coiled tubing in lieu of flex lines or hoses for hydraulic line routing from the airframe to the strut.
		LG-10	All wiring or coax mounted to a strut should have appropriate interface connectors to simplify strut removal and installation.
		LG-11	All microswitches, proximity switches, lights, sensors, etc. mounted to a strut should have individual interface connectors.
		LG-13	Wiring pigtailed requiring in-line splices should be avoided.
		LG-14	No special tools or equipment should be required to maintain/service struts in normal day-to-day operational environments.
		LG-15	All interfaces from the airframe to the struts should be visible and accessible, and not require removal of airframe structure for access.
		LG-16	No portion of the landing gear closure door(s) should be attached to the strut. In rare instances where this may not be possible, that attached portion should not require alignment or rigging.
		LG-17	No portion of the landing gear rigging process should require support equipment type templates, gauges, or tools. Indexes, reference points, etc., should be an integral part of the landing gear/airframe design.
			Hydraulic, pneumatic, or electrical actuators associated with landing gear systems should not require adjustment or rigging once installed in the air vehicle. Spare units should be rigged at the time of manufacture or overhaul.

MIL-HDBK-470A

APPENDIX C

Guidelines by Category (Cont'd)

Category No.	Category Title	Guideline No.	Guideline
3.10.04	Skids and Floats	LG-18	Landing gear ground safety down locks should be an integral part of the overall design. Use or reliance on loose pins (support equipment) should be avoided.
		LG-19	When deemed necessary for the respective design, pilots, flight crews, or operators should have an indication of the downlock status in the cockpit or crew station to avoid the necessity of a flight abort.
		LG-20	Special locks and pins used solely for landing gear ground maintenance safety should be used only in those cases substantiated by cost effectiveness analysis.
		LG-21	Proximity type switches used in landing gear design should meet a minimum of 200 volt-amperes to eliminate Electromagnetic Interference (EMI) or Radiation Hazard (RADHAD) problems. Wiring associated with the landing gear design should meet the same requirements.
		LG-23	Design strut fittings for servicing nitrogen or hydraulic fluid to be easily accessible and adjacent to the appropriate strut pressure gage.
		LG-24	Design struts so they can be serviced with clean, dry air in lieu of nitrogen during deployments without affecting the overall reliability.
		LG-25	Mechanical shrink struts, when used, should not permit gear to jam in wheel well if failure of shrink mechanism occurs.
		LG-26	Gravitational emergency extension of landing gear should be given preference over all other concepts.
		LG-27	Downlocks should be over-center mechanical type and should not depend on hydraulic pressure to maintain the lock.
		LG-28	Landing gear control handle should have only "up" or "down" detents with no neutral or intermediate positions.
		LG-29	Basic gear design combined with manufacturing tolerances should ensure that no uplock or downlock rigging is required.
		LG-30	Do not use landing gear wells to locate any type of auxiliary air inlet.
		LG-31	Landing gear doors designed to close after gear is extended should be capable of being manually opened on the ground without reliance on electrical or hydraulic power.
		LG-32	Design of landing gear doors normally closed after gear extension should ensure failure modes will not enable uncommanded opening on the ground.
		LG-33	Design of landing gear doors normally left open after gear extension should ensure no failure mode will enable closing on the ground.
		LG-34	Avoid sharp edges and corners on landing gear doors or fairings.
		LG-35	Avoid the use of landing gear doors to mount or house antennas, arrays, or air data sensors.
		MC-01	All clamps should contain torque-set or torque-limiting connections to prevent clamp or component failure due to over-torque. Clamp installation call outs should not depend on special tools to establish the required torque values.
		MC-02	Avoid the use of cotter pins, safety wire, safety clips, and similar devices to prevent maintenance-induced events leading to ground vehicle accidents or loss of air vehicles.
		MC-03	All tubing connections and interfaces should use rosan/dynatube (or equivalent) to (1) enable connect or disconnect with one hand, one tool, (2) eliminate the need to safety the connection, (3) provide a superior seal, and (4) negate need to reposition line(s) during component replacement.
		MC-04	No trombone type, flared tube type, or piloted line type interfaces should be used to avoid the need for removal or repositioning during equipment removal.
		MC-06	Locate, position, orient all plumbing and duct electrical connectors to prevent the need for sequential installation or removal.
		MC-09	All plumbing connections and fittings used for fuel systems should contain integral bonding features to eliminate the need for bonding clamps or jumper cables.
		MC-10	In rare instances where a plumbing run contains complex form or geometry that would require removal of other plumbing or equipment for access, in-line connectors should be incorporated to maintain the integrity of other plumbing or equipment.
		MC-11	No subsystem plumbing, equipment, or wiring should use a tank, cell, or compartment containing liquids as a means for routing or penetration simplicity during manufacture.
		MC-12	All plumbing and connectors containing liquids should be meniscus-free.

MIL-HDBK-470A

APPENDIX C

Guidelines by Category (Cont'd)

Category No.	Category Title	Guideline No.	Guideline
3.10.04	Skids and Floats	MC-13	In instances where plumbing or connector interfaces cannot or are not keyed for a specific orientation, all identification, markings, cautions, and directions should be placed 360 degrees around the tube or duct.
		MC-14	Where multiple connectors are located in close proximity, ensure (1) a minimum hand tool arc of 120 degrees can be maintained, and (2) stagger fittings to ensure firm coupling interface/hand tool interface can be accomplished without inducing damage to adjacent lines.
		MP-01	Avoid the use of epoxies to mount parts on repairable modules because they make repair extremely difficult.
		MP-02	Use a unique identification (ID) resistor incorporated in each system module to verify that the proper module is mounted on ATE.
		MP-03	Design modules so that lengthy warm-up times, special coding and air purity levels, and similar constraints are not necessary.
		P-01	Access door and panel fastener types for airborne vehicles should meet the following criteria: <ul style="list-style-type: none"> - use latches for a frequency of access of 0 to 40 flight hours - use High Strength Quick Release fasteners for a frequency of access of 40-400 flight hours - use structural screws for a frequency of access of 400 flight hours or more
		P-02	Access door and panel fastener types for surface vehicles should meet the following criteria: <ul style="list-style-type: none"> - use a spring loaded or latch fastener for an opening frequency of daily - use a one quarter turn fastener (or equivalent) for a opening frequency of weekly - use screws or bolts for all other cases
		P-03	All doors and panels subject to environmental elements should contain form-in-place seals (or equivalent) attached to the door structure, not substructure, to prevent damage during maintenance.
		P-04	Door and panel seals should be compatible with all types of on-board servicing fluids, de-ice and anti-ice fluids, and all fluids used for chemical, biological, and nuclear decontamination.
		P-05	Piano type hinges should not be used on doors or panels because they are subject to wear, corrosion, and sand and fluid entry.
		P-06	Access door and panel devices used to support door in opened position should meet the following criteria: <ul style="list-style-type: none"> - for airborne vehicles, design for 60 knot gust loads (or equivalent jet blast loads) - for ground vehicles, design for 50 mph gust loads
		P-07	Hinged access doors and panels capable of remaining in the opened position should not have sharp edges or corners.
		P-08	Removable access door and panel fasteners should be of identical grip length and diameter.
		P-09	Acceptable door and panel hold-open devices include over-center sheet metal spring, over-center spring link, spring cartridge, support strut, and pinned goose neck hinge.
		P-10	Access doors and panels requiring non-captive fasteners should not be located forward of air inlet ducts or high-energy rotating components (e.g., prop fans, engine cooling fans, etc.).
		P-11	Access doors and panels should be interchangeable as justified by operation and support costs or life cycle costs.
		SABCH-06	Structural design should avoid the potential of dissimilar material or fastener corrosion.
		SABCH-07	No structural fasteners should be used that require special tools for installation.
		SABCH-08	Taper pins should be threaded and retained with self-locking hardware.
		SABCH-09	Pins and collars (lockbolts) should only be used in applications which do not normally require removal.
		SABCH-10	Do not use lockbolts in composites.
		SABCH-11	In rare instances where the use of dissimilar material in immediate contact cannot be avoided, they should be sufficiently insulated to endure for the life of the vehicle.
		SABCH-12	Avoid tapping threads into structural members. Use of heli-coil type or similar insert concepts is permissible.
		SABCH-13	No structural design concept should rely on frequent scheduled inspections to monitor or otherwise ensure structural integrity.
		SABCH-14	No structural fastener intended to carry shear or tension loads should be smaller than 1/4" diameter (.25").
		SABCH-15	Give preference to butt type splices over lap type splices in the design of manufacturing splices.

Guidelines by Category (Cont'd)

Category No.	Category Title	Guideline No.	Guideline
3.10.04	Skids and Floats	SABCH-16	Wing-to-fuselage attachment should give preference to tension ties over shear ties to improve overall volumetric efficiency.
		SABCH-17	Hardpoints for securing tie down chains, cables, and devices during transport should not require reaching under or crawling under the vehicle.
		SABCH-18	Rings, posts, and clevis devices used for attaching tie downs should not require opening of doors or panels for access.
		SABCH-19	Avoid tie down concepts requiring attaching hardpoints as a prerequisite.
		SABCH-20	Location of hardpoints used for tie down attachment should: <ul style="list-style-type: none"> - Remain outside of door and panel opening envelopes. - Be clear of exhaust pipes, ducts, manifolds, and mufflers. - Be clear of overboard fluid drains and vents.
		SI-03	Parts and assemblies of a given model product or of models of a product in the same series should be interchangeable or replaceable.
		SIMP-02	Landing and taxi lights should be mounted on landing gear struts or doors to eliminate separate compartments, doors, and retraction/extension mechanisms.
		SKID-01	Design non-metallic floats to be impervious to all fluids used on board the host vehicle.
		SKID-02	Design non-metallic floats to be highly resistant to scuffing and abrasion.
		SKID-03	Design non-metallic floats with a color-coded inner ply to readily denote when maximum abrasion limits have been reached.
		SKID-04	Design pneumatic floats with an integral air gage located adjacent to the air fill fitting.
		SKID-05	Design metallic and composite floats and skids to the same environmental criteria as the airframe, including finishes.
		SKID-06	Use non-skid finishes on the upper surfaces of skids and floats for use as steps and walkways.
		SKID-07	Design floats with simple drain provisions for each compartment.
3.10.05	Hooks and Catapults	A-04	Use stiffening beads in lieu of flanges to the maximum extent to enhance compartment volume and simplify repairs.
		A-05	Stiffening beads should have the convex surface toward the compartment to eliminate fluid traps.
		A-06	Keep all machined compartment frames, webs, and closure panels to a constant thickness (e.g., not stepped or tapered) to ease simplicity of fluid or electrical penetrations and ease and simplicity of structural repair.
		A-16	Hardpoints (structural attachment and load bearing areas) within a compartment to assist in equipment mounting or support should not be integral with the machined part. Hardpoints should be parasitic to enable quick repair in case of wear or damage in lieu of precise ream/bush repair typical of machined hardpoints.
		A-18	Structural design should provide good access to corrosion-prone areas for inspection and treatment.
		BIT-01	Use transparent windows, quick-opening covers, or openings without any cover to permit quick visual inspections where needed.
		BIT-02	During design of the BIT, use worst-case stress analysis to ensure that any circuit failures induced by temperature extremes, tolerance build-up, power supply variations, and combinations thereof are identified.
		BIT-03	Ensure that BIT system thresholds are consistent with those across the system, subsystem, item, module, and piece-part levels to prevent excessive numbers of Cannot Duplicate (CND) and Retest OK (RTOK) events from occurring.
		BIT-04	The degree of BIT required or proposed should be based on the respective failure rates and the appropriate FMECA at all equipment indenture levels.
		BIT-06	Limit the amount of data that is recorded to a manageable size by:
		BIT-09	<ul style="list-style-type: none"> - Limiting the number of signals that are monitored - Limiting the maximum sampling rate - Reducing the time span over which data is accumulated - Restricting the type of data accumulated
		BIT-16	Mission critical functions should be monitored by BIT. Use concurrent BIT to monitor system critical functions. Critical voltages should be visually monitored by sending the voltage signals to visible LEDs.

Guidelines by Category (Cont'd)

Category No.	Category Title	Guideline No.	Guideline
3.10.05	Hooks and Catapults	BIT-20	The BIT should be mechanized so that when a piece of equipment is not installed in a subsystem or the product, a failure will not be indicated.
		BIT-26	Locate routinely used test points so they are accessible without removing or disassembling other equipment.
		CONT-01	Control rods should use Boyd or impedance type bolts (or equivalent) to eliminate the need for cotter pins or safety wire.
		CONT-02	Do not use metal control cables for vehicles that will operate in salt water or salt air environments.
		CONT-03	Use control rods rather than control cables for non-complex applications and non-complex routing within the vehicle.
		CONT-04	Use control cables rather than control rods for most complex applications.
		CONT-05	Route cables so that 100 percent of a cable will be viewable for inspection.
		CONT-06	Design all pulleys and brackets associated with cable installations so they are accessible by a 75 percentile male hand.
		D&V-01	The geometric aspects of structural design and interfaces should not result in any natural bathtubs.
		D&V-02	Closed structural sections subject to condensation or fluid migration should contain drainage provisions.
		D&V-03	Crew cabs, operators' compartments, crew stations, cockpits, and passenger compartments should be subject to the same corrosion prevention measures as the exteriors of the vehicles. Low points, pockets, and related fluid collection points within should be provided with low point drains.
		EC-15	The removal or replacement of electronic equipment should not require the removal of any other piece of equipment or armament.
		ENV-03	For airborne vehicles, the finishes should be durable against rain, hail, and dynamic erosion throughout the flight envelope.
		ENV-04	For airborne and ground vehicles, the finishes should be durable against sand erosion throughout all surface wind speeds experienced in arid or desert geographical locations.
		HOOK-01	Locate, orient, and mechanize Nose Gear Tow/Nose Gear Holdback (NGT/NGH) mechanisms so they do not interfere with the hookup and attachment of standard towbars.
		HOOK-02	Design NGT/NGH mechanisms with integral provisions to visually indicate correct hookup/attachment. The indication must be visible during all day and night carrier operations.
		HOOK-03	NGT/NGH mechanisms should not require scheduled visual or NDI type inspections.
		HOOK-04	Design tail hook points to be interchangeable and easily replaceable.
		HOOK-05	Design tail hook points so they can not be incorrectly installed.
		HOOK-06	Avoid the need to remove the tail hook to facilitate engine access or removal.
		HYD-09	Provide hydraulic devices used in critical applications with integral 5 micron filtering.
		HYD-11	Design flexible hose with molded-in color bands to clearly indicate when the maximum wear/abrasion has been reached.
		LG-01	Bearings, excluding wheel bearings, should not require lubrication during the expected life of the air vehicle airframe.
		LG-02	Hardpoints for attachment of landing gear trunnions should be capable of carrying all induced gear loads for the life of the airframe.
		LG-03	Hardpoints for attachment for landing gear trunnions should not be machined as an integral part of the airframe structure when normal design sink rates over 25 feet per second are required.
		LG-04	Do not use Beryllium and Beryllium base alloys in any location subject to wear or corrosive atmospheres or in installations where machining may be required.
		LG-05	All bolts or similar threaded means used as adjustable stops should be positively retained in the adjusted reference without reliance on jam nuts, cotter pins, or safety wire.
		LG-06	Design struts, attachments, and interfaces so they do not depend on scheduled visual inspections, non-destructive inspection (NDI), or non-destructive test (NDT) to ensure the reliability or integrity of the system in the operational environment.
		LG-07	No portion of the landing gear struts, drag braces, or interfaces should contain pockets or bathtubs that can trap or hold moisture. In rare instances where this is not possible, holes should be drilled as appropriate to prevent moisture/liquid accumulation.

MIL-HDBK-470A

APPENDIX C

Guidelines by Category (Cont'd)

Category No.	Category Title	Guideline No.	Guideline
3.10.05	Hooks and Catapults	LG-08	Brackets, levers, links, rods, et al mounted on the struts should either be symmetrical to tolerate reverse installation or should be impossible to reverse.
		LG-09	Use coiled tubing in lieu of flex lines or hoses for hydraulic line routing from the airframe to the strut.
		LG-10	All wiring or coax mounted to a strut should have appropriate interface connectors to simplify strut removal and installation.
		LG-11	All microswitches, proximity switches, lights, sensors, etc. mounted to a strut should have individual interface connectors.
		LG-13	Wiring pigtailed requiring in-line splices should be avoided.
		LG-14	No special tools or equipment should be required to maintain/service struts in normal day-to-day operational environments.
		LG-15	All interfaces from the airframe to the struts should be visible and accessible, and not require removal of airframe structure for access.
		LG-16	No portion of the landing gear closure door(s) should be attached to the strut. In rare instances where this may not be possible, that attached portion should not require alignment or rigging.
		LG-17	No portion of the landing gear rigging process should require support equipment type templates, gauges, or tools. Indexes, reference points, etc., should be an integral part of the landing gear/airframe design.
		LG-18	Hydraulic, pneumatic, or electrical actuators associated with landing gear systems should not require adjustment or rigging once installed in the air vehicle. Spare units should be rigged at the time of manufacture or overhaul.
		LG-19	Landing gear ground safety down locks should be an integral part of the overall design. Use or reliance on loose pins (support equipment) should be avoided.
		LG-20	When deemed necessary for the respective design, pilots, flight crews, or operators should have an indication of the downlock status in the cockpit or crew station to avoid the necessity of a flight abort.
		LG-21	Special locks and pins used solely for landing gear ground maintenance safety should be used only in those cases substantiated by cost effectiveness analysis.
		LG-23	Proximity type switches used in landing gear design should meet a minimum of 200 volt-amperes to eliminate Electromagnetic Interference (EMI) or Radiation Hazard (RADHAD) problems. Wiring associated with the landing gear design should meet the same requirements.
		LG-24	Design strut fittings for servicing nitrogen or hydraulic fluid to be easily accessible and adjacent to the appropriate strut pressure gage.
		LG-25	Design struts so they can be serviced with clean, dry air in lieu of nitrogen during deployments without affecting the overall reliability.
		LG-26	Mechanical shrink struts, when used, should not permit gear to jam in wheel well if failure of shrink mechanism occurs.
		LG-27	Gravitational emergency extension of landing gear should be given preference over all other concepts.
		LG-28	Downlocks should be over-center mechanical type and should not depend on hydraulic pressure to maintain the lock.
		LG-29	Landing gear control handle should have only "up" or "down" detents with no neutral or intermediate positions.
		LG-30	Basic gear design combined with manufacturing tolerances should ensure that no uplock or downlock rigging is required.
		LG-31	Do not use landing gear wells to locate any type of auxiliary air inlet.
		LG-32	Landing gear doors designed to close after gear is extended should be capable of being manually opened on the ground without reliance on electrical or hydraulic power.
		LG-33	Design of landing gear doors normally closed after gear extension should ensure failure modes will not enable uncommanded opening on the ground.
		LG-34	Design of landing gear doors normally left open after gear extension should ensure no failure mode will enable closing on the ground.
		LG-35	Avoid sharp edges and corners on landing gear doors or fairings.
		MC-01	Avoid the use of landing gear doors to mount or house antennas, arrays, or air data sensors.
			All clamps should contain torque-set or torque-limiting connections to prevent clamp or component failure due to over-torque. Clamp installation call outs should not depend on special tools to establish the required torque values.

Guidelines by Category (Cont'd)

Category No.	Category Title	Guideline No.	Guideline
3.10.05	Hooks and Catapults	MC-02	Avoid the use of cotter pins, safety wire, safety clips, and similar devices to prevent maintenance-induced events leading to ground vehicle accidents or loss of air vehicles.
		MC-03	All tubing connections and interfaces should use rosan/dynatube (or equivalent) to (1) enable connect or disconnect with one hand, one tool, (2) eliminate the need to safety the connection, (3) provide a superior seal, and (4) negate need to reposition line(s) during component replacement.
		MC-04	No trombone type, flared tube type, or piloted line type interfaces should be used to avoid the need for removal or repositioning during equipment removal.
		MC-06	Locate, position, orient all plumbing and duct electrical connectors to prevent the need for sequential installation or removal.
		MC-09	All plumbing connections and fittings used for fuel systems should contain integral bonding features to eliminate the need for bonding clamps or jumper cables.
		MC-10	In rare instances where a plumbing run contains complex form or geometry that would require removal of other plumbing or equipment for access, in-line connectors should be incorporated to maintain the integrity of other plumbing or equipment.
		MC-11	No subsystem plumbing, equipment, or wiring should use a tank, cell, or compartment containing liquids as a means for routing or penetration simplicity during manufacture.
		MC-12	All plumbing and connectors containing liquids should be meniscus-free.
		MC-13	In instances where plumbing or connector interfaces cannot or are not keyed for a specific orientation, all identification, markings, cautions, and directions should be placed 360 degrees around the tube or duct.
		MC-14	Where multiple connectors are located in close proximity, ensure (1) a minimum hand tool arc of 120 degrees can be maintained, and (2) stagger fittings to ensure firm coupling interface/hand tool interface can be accomplished without inducing damage to adjacent lines.
		MP-01	Avoid the use of epoxies to mount parts on repairable modules because they make repair extremely difficult.
		MP-02	Use a unique identification (ID) resistor incorporated in each system module to verify that the proper module is mounted on ATE.
		MP-03	Design modules so that lengthy warm-up times, special coding and air purity levels, and similar constraints are not necessary.
		P-01	Access door and panel fastener types for airborne vehicles should meet the following criteria: <ul style="list-style-type: none"> - use latches for a frequency of access of 0 to 40 flight hours - use High Strength Quick Release fasteners for a frequency of access of 40-400 flight hours - use structural screws for a frequency of access of 400 flight hours or more
		P-02	Access door and panel fastener types for surface vehicles should meet the following criteria: <ul style="list-style-type: none"> - use a spring loaded or latch fastener for an opening frequency of daily - use a one quarter turn fastener (or equivalent) for a opening frequency of weekly - use screws or bolts for all other cases
		P-03	All doors and panels subject to environmental elements should contain form-in-place seals (or equivalent) attached to the door structure, not substructure, to prevent damage during maintenance.
		P-04	Door and panel seals should be compatible with all types of on-board servicing fluids, de-ice and anti-ice fluids, and all fluids used for chemical, biological, and nuclear decontamination.
		P-05	Piano type hinges should not be used on doors or panels because they are subject to wear, corrosion, and sand and fluid entry.
		P-06	Access door and panel devices used to support door in opened position should meet the following criteria: <ul style="list-style-type: none"> - for airborne vehicles, design for 60 knot gust loads (or equivalent jet blast loads) - for ground vehicles, design for 50 mph gust loads
		P-07	Hinged access doors and panels capable of remaining in the opened position should not have sharp edges or corners.
		P-08	Removable access door and panel fasteners should be of identical grip length and diameter.

Guidelines by Category (Cont'd)

Category No.	Category Title	Guideline No.	Guideline
3.10.05	Hooks and Catapults	P-09	Acceptable door and panel hold-open devices include over-center sheet metal spring, over-center spring link, spring cartridge, support strut, and pinned goose neck hinge.
		P-10	Access doors and panels requiring non-captive fasteners should not be located forward of air inlet ducts or high-energy rotating components (e.g., prop fans, engine cooling fans, etc.).
		P-11	Access doors and panels should be interchangeable as justified by operation and support costs or life cycle costs.
		SABCH-06	Structural design should avoid the potential of dissimilar material or fastener corrosion.
		SABCH-07	No structural fasteners should be used that require special tools for installation.
		SABCH-08	Taper pins should be threaded and retained with self-locking hardware.
		SABCH-09	Pins and collars (lockbolts) should only be used in applications which do not normally require removal.
		SABCH-10	Do not use lockbolts in composites.
		SABCH-11	In rare instances where the use of dissimilar material in immediate contact cannot be avoided, they should be sufficiently insulated to endure for the life of the vehicle.
		SABCH-12	Avoid tapping threads into structural members. Use of heli-coil type or similar insert concepts is permissible.
		SABCH-13	No structural design concept should rely on frequent scheduled inspections to monitor or otherwise ensure structural integrity.
		SABCH-14	No structural fastener intended to carry shear or tension loads should be smaller than 1/4" diameter (.25").
		SABCH-15	Give preference to butt type splices over lap type splices in the design of manufacturing splices.
		SABCH-16	Wing-to-fuselage attachment should give preference to tension ties over shear ties to improve overall volumetric efficiency.
		SABCH-17	Hardpoints for securing tie down chains, cables, and devices during transport should not require reaching under or crawling under the vehicle.
		SABCH-18	Rings, posts, and clevis devices used for attaching tie downs should not require opening of doors or panels for access.
		SABCH-19	Avoid tie down concepts requiring attaching hardpoints as a prerequisite.
		SABCH-20	Location of hardpoints used for tie down attachment should: - Remain outside of door and panel opening envelopes. - Be clear of exhaust pipes, ducts, manifolds, and mufflers. - Be clear of overboard fluid drains and vents.
		SAFE-07	Landing and alighting gear design should ensure downlocks are integral to the mechanisms and provide a clear indication of position status. This guideline also applies to tail hooks.
		SI-03	Parts and assemblies of a given model product or of models of a product in the same series should be interchangeable or replaceable.
3.11	Personnel Equipment	A-13	Two-sided or two-surfaced access should not be required for access to equipment interfaces and hardpoints. The term two-sided infers top/bottom, left/right, front/back, or combinations thereof.
		ARM-06	The relationship of the nose landing gear to the main landing gear should not restrict the positioning of weapon transporters under the fuselage of an aircraft.
		BIT-06	Mission critical functions should be monitored by BIT.
		BIT-09	Use concurrent BIT to monitor system critical functions.
		FI-06	In an airborne avionics system, consider indicating mission critical faults on a pilots "head-up" display accompanied with an audible alarm, so that the pilot can easily check for critical system or mission threatening problems.
		FI-07	Ensure that system user manuals include instructions for faults not covered by BIT such as, system will not power up or system is being used in an incorrect environment such as, at the wrong altitude, etc.
		FI-08	Interlock the high power sections of systems and subsystems with visual/audible BIT to ensure safe system activation.
		FI-09	Design BIT to first conduct self-test for circuitry integrity before conducting system test.
		FI-10	Use clear text to report failures rather than alpha-numeric codes, lights, indicators, etc.
		FI-11	Locate BIT circuitry on the same level of the subsystem under test to simplify test and repair when it is removed from the main system.

Guidelines by Category (Cont'd)

Category No.	Category Title	Guideline No.	Guideline
3.11	Personnel Equipment	MC-01	All clamps should contain torque-set or torque-limiting connections to prevent clamp or component failure due to over-torque. Clamp installation call outs should not depend on special tools to establish the required torque values.
		MC-02	Avoid the use of cotter pins, safety wire, safety clips, and similar devices to prevent maintenance-induced events leading to ground vehicle accidents or loss of air vehicles.
		MC-03	All tubing connections and interfaces should use rosan/dynatube (or equivalent) to (1) enable connect or disconnect with one hand, one tool, (2) eliminate the need to safety the connection, (3) provide a superior seal, and (4) negate need to reposition line(s) during component replacement.
		MC-04	No trombone type, flared tube type, or piloted line type interfaces should be used to avoid the need for removal or repositioning during equipment removal.
		MC-06	Locate, position, orient all plumbing and duct electrical connectors to prevent the need for sequential installation or removal.
		MC-11	No subsystem plumbing, equipment, or wiring should use a tank, cell, or compartment containing liquids as a means for routing or penetration simplicity during manufacture.
		MC-12	All plumbing and connectors containing liquids should be meniscus-free.
		MC-14	Where multiple connectors are located in close proximity, ensure (1) a minimum hand tool arc of 120 degrees can be maintained, and (2) stagger fittings to ensure firm coupling interface/hand tool interface can be accomplished without inducing damage to adjacent lines.
		MP-01	Avoid the use epoxies to mount parts on repairable modules because they make repair extremely difficult.
		MP-02	Use a unique identification (ID) resistor incorporated in each system module to verify that the proper module is mounted on ATE.
		MP-03	Design modules so that lengthy warm-up times, special coding and air purity levels, and similar constraints are not necessary.
		PERS-01	Group man-machine interfaces manifold-style to enable connect/disconnect in a single action.
		PERS-02	Include an integral, highly visible indicator in a man-machine interface connector to denote connector is seated and locked.
		PERS-03	Design interface connectors so that a distinct action is required by an individual to effect a disconnect. (Excludes airframe-to-ejection seat personnel interfaces.)
		PERS-04	Interfaces should contain an emergency release mechanism that can be activated by rescue personnel with a 95 percentile gloved hand.
		PERS-05	Design emergency interface release mechanisms to be clearly visible under all types of lighting situations.
		PERS-06	Storage bins, compartments, sacks, or bags should be available within the vehicle to store/protect all personal equipment required to conduct operations.
		PERS-07	All flight and ground vehicles should contain one cubic foot minimum storage compartment(s) for various loose and sundry personal items (for each individual).
		PERS-08	Design stowage and mounting provisions for portable air or oxygen containers to withstand 40G crash or impact loads.
		PERS-09	Design portable emergency locator beacons, radio receiver/transmitters, global positioning systems, and similar battery operated devices with integral provisions for determining battery health or status and remaining battery life.
		SAFE-03	Stored energy devices (e.g., accumulators, nitrogen bottles, gas generators, etc.), that could cause injury, harm, or damage if inadvertently actuated, should contain integral safing provisions.
		SI-03	Parts and assemblies of a given model product or of models of a product in the same series should be interchangeable or replaceable.
		A-08	Plumbing penetrations into a compartment should not be on a vertical axis due to difficulty in making or breaking vertically-oriented connections. When compartment access is from the bottom, vertically-oriented connections can allow fluid to leak onto the maintainer. When access is from the top, such connections can allow foreign matter to enter the line. Use horizontal penetrations whenever possible.
	Oxygen Systems, Masks, Controls, and Containers	A-18	Use transparent windows, quick-opening covers, or openings without any cover to permit quick visual inspections where needed.
3.11.01			

Guidelines by Category (Cont'd)

Category No.	Category Title	Guideline No.	Guideline
3.11.01	Oxygen Systems, Masks, Controls, and Containers	BIT-01	During design of the BIT, use worst-case stress analysis to ensure that any circuit failures induced by temperature extremes, tolerance build-up, power supply variations, and combinations thereof are identified.
		BIT-02	Ensure that BIT system thresholds are consistent with those across the system, subsystem, item, module, and piece-part levels to prevent excessive numbers of Cannot Duplicate (CND) and Retest OK (RTOK) events from occurring.
		BIT-03	The degree of BIT required or proposed should be based on the respective failure rates and the appropriate FMECA at all equipment indenture levels.
		BIT-04	Limit the amount of data that is recorded to a manageable size by: <ul style="list-style-type: none"> - Limiting the number of signals that are monitored - Limiting the maximum sampling rate - Reducing the time span over which data is accumulated - Restricting the type of data accumulated
		BIT-05	Incorporate testability design features as an integral part of equipment preliminary design process.
		BIT-06	Mission critical functions should be monitored by BIT.
		BIT-09	Use concurrent BIT to monitor system critical functions.
		BIT-16	Critical voltages should be visually monitored by sending the voltage signals to visible LEDs.
		BIT-20	The BIT should be mechanized so that when a piece of equipment is not installed in a subsystem or the product, a failure will not be indicated.
		CBR-01	Orient all vehicle liquid servicing fittings to ensure fluids will not come in contact with protective garb during connect/disconnect activities.
		CBR-02	Ensure vehicle overboard passive liquid drains are clearly marked or visible to enable personnel to remain clear of area.
		ECS-01	Design so that equipment servicing status are accessible and readable from the ground level for air vehicles and from the operator's position for ground and water vehicles.
		MC-01	All clamps should contain torque-set or torque-limiting connections to prevent clamp or component failure due to over-torque. Clamp installation call outs should not depend on special tools to establish the required torque values.
		MC-02	Avoid the use of cotter pins, safety wire, safety clips, and similar devices to prevent maintenance-induced events leading to ground vehicle accidents or loss of air vehicles.
		MC-03	All tubing connections and interfaces should use rosan/dynatube (or equivalent) to (1) enable connect or disconnect with one hand, one tool, (2) eliminate the need to safety the connection, (3) provide a superior seal, and (4) negate need to reposition line(s) during component replacement.
		MC-04	No trombone type, flared tube type, or piloted line type interfaces should be used to avoid the need for removal or repositioning during equipment removal.
		MC-05	Avoid potential foreign object traps during manufacturing or operational maintenance by eliminating vertical penetrations of plumbing/fittings into tanks, compartments, or cells
		MC-06	Locate, position, orient all plumbing and duct electrical connectors to prevent the need for sequential installation or removal.
		MC-09	All plumbing connections and fittings used for fuel systems should contain integral bonding features to eliminate the need for bonding clamps or jumper cables.
		MC-11	No subsystem plumbing, equipment, or wiring should use a tank, cell, or compartment containing liquids as a means for routing or penetration simplicity during manufacture.
		MC-12	All plumbing and connectors containing liquids should be meniscus-free.
		MC-14	Where multiple connectors are located in close proximity, ensure (1) a minimum hand tool arc of 120 degrees can be maintained, and (2) stagger fittings to ensure firm coupling interface/hand tool interface can be accomplished without inducing damage to adjacent lines.
		MP-01	Avoid the use epoxies to mount parts on repairable modules because they make repair extremely difficult.
		MP-02	Use a unique identification (ID) resistor incorporated in each system module to verify that the proper module is mounted on ATE.

Guidelines by Category (Cont'd)

Category No.	Category Title	Guideline No.	Guideline
3.11.01	Oxygen Systems, Masks, Controls, and Containers	MP-03	Design modules so that lengthy warm-up times, special coding and air purity levels, and similar constraints are not necessary.
		OXY-03	Provide condition sensors for oxygen concentrators to eliminate periodic and/or forced replacement.
		OXY-11	System operational and service condition status should be capable of being downlinked to centralized maintenance facilities.
		OXY-12	LOX compartments should be sealed from adjacent compartments and should contain dedicated overboard drains.
		P-06	Access door and panel devices used to support door in opened position should meet the following criteria: - for airborne vehicles, design for 60 knot gust loads (or equivalent jet blast loads) - for ground vehicles, design for 50 mph gust loads
		P-07	Hinged access doors and panels capable of remaining in the opened position should not have sharp edges or corners.
		P-08	Removable access door and panel fasteners should be of identical grip length and diameter.
		P-09	Acceptable door and panel hold-open devices include over-center sheet metal spring, over-center spring link, spring cartridge, support strut, and pinned goose neck hinge.
		P-10	Access doors and panels requiring non-captive fasteners should not be located forward of air inlet ducts or high-energy rotating components (e.g., prop fans, engine cooling fans, etc.).
		P-11	Access doors and panels should be interchangeable as justified by operation and support costs or life cycle costs.
		PERS-01	Group man-machine interfaces manifold-style to enable connect/disconnect in a single action.
		PERS-02	Include an integral, highly visible indicator in a man-machine interface connector to denote connector is seated and locked.
		PERS-03	Design interface connectors so that a distinct action is required by an individual to effect a disconnect. (Excludes airframe-to-ejection seat personnel interfaces.)
		PERS-04	Interfaces should contain an emergency release mechanism that can be activated by rescue personnel with a 95 percentile gloved hand.
		PERS-05	Design emergency interface release mechanisms to be clearly visible under all types of lighting situations.
		PERS-08	Design stowage and mounting provisions for portable air or oxygen containers to withstand 40G crash or impact loads.
		SI-03	Parts and assemblies of a given model product or of models of a product in the same series should be interchangeable or replaceable.
3.11.02	Personnel Protective Garments and Equipment	BIT-06	Mission critical functions should be monitored by BIT.
		BIT-09	Use concurrent BIT to monitor system critical functions.
		CBR-01	Orient all vehicle liquid servicing fittings to ensure fluids will not come in contact with protective garb during connect/disconnect activities.
		CBR-02	Ensure vehicle overboard passive liquid drains are clearly marked or visible to enable personnel to remain clear of area.
		CREW-02	Armor protection integrated with the vehicle structure should be given preference over parasitic armor.
		CREW-03	In rare cases where armor is parasitic, armor should be interchangeable and easily installed.
		ENV-01	Materials, treatments, coatings, finishes should be compatible with all anti-ice and de-ice fluids, chemical and biological decontamination fluids, washing and cleaning fluids, and all vehicle subsystem fluids.
		ENV-02	There should be no top coat or treatment deterioration throughout the standard temperature and humidity spectrum.
		ENV-06	For ground vehicles, the finishes should be compatible with and durable against all rain, hail, sleet, snow, and ice conditions experienced in all intended operational environments.
		FUEL-01	Locate fuel vent and dump masts to ensure exiting fuel will be clear of servicing, loading, arming and safing areas for all types of ground and airborne vehicles.
		MC-01	All clamps should contain torque-set or torque-limiting connections to prevent clamp or component failure due to over-torque. Clamp installation call outs should not depend on special tools to establish the required torque values.
		MC-02	Avoid the use of cotter pins, safety wire, safety clips, and similar devices to prevent maintenance-induced events leading to ground vehicle accidents or loss of air vehicles.

Guidelines by Category (Cont'd)

Category No.	Category Title	Guideline No.	Guideline
3.11.02	Personnel Protective Garments and Equipment	MC-06	Locate, position, orient all plumbing and duct electrical connectors to prevent the need for sequential installation or removal.
		MC-12	All plumbing and connectors containing liquids should be meniscus-free.
		MC-14	Where multiple connectors are located in close proximity, ensure (1) a minimum hand tool arc of 120 degrees can be maintained, and (2) stagger fittings to ensure firm coupling interface/hand tool interface can be accomplished without inducing damage to adjacent lines.
		PERS-01	Group man-machine interfaces manifold-style to enable connect/disconnect in a single action.
		PERS-02	Include an integral, highly visible indicator in a man-machine interface connector to denote connector is seated and locked.
		PERS-03	Design interface connectors so that a distinct action is required by an individual to effect a disconnect. (Excludes airframe-to-ejection seat personnel interfaces.)
		PERS-04	Interfaces should contain an emergency release mechanism that can be activated by rescue personnel with a 95 percentile gloved hand.
		PERS-05	Design emergency interface release mechanisms to be clearly visible under all types of lighting situations.
		PERS-06	Storage bins, compartments, sacks, or bags should be available within the vehicle to store/protect all personal equipment required to conduct operations.
		PERS-07	All flight and ground vehicles should contain one cubic foot minimum storage compartment(s) for various loose and sundry personal items (for each individual).
		PERS-08	Design stowage and mounting provisions for portable air or oxygen containers to withstand 40G crash or impact loads.
		SI-03	Parts and assemblies of a given model product or of models of a product in the same series should be interchangeable or replaceable.
		SURV-01	Design containers used for dinghy stowage to be structurally capable of containing the dinghy within the event of unintentional or uncommanded inflation.
		SURV-02	Provide crew stations, crew compartments, and operator areas containing dinghies as emergency equipment with a suitable tool for puncturing or cutting the dinghy in the event of inadvertent inflation. Locate the tool so that access is assured during dinghy inflation.
		SURV-03	Survival gear containerization or storage should have a minimum twelve-month period between scheduled tests, checks, or replacements.
		SURV-04	Do not seal battery power or battery-operated devices in survival packages or containers. When this guideline cannot be followed, provide a remote way of ascertaining the status or condition of the battery.
		SURV-05	Design survival equipment pods intended for external carriage or suspension to meet the same environmental and operational criteria as the host vehicle structure.
3.11.03	Parachutes	A-18	Use transparent windows, quick-opening covers, or openings without any cover to permit quick visual inspections where needed.
		MC-02	Avoid the use of cotter pins, safety wire, safety clips, and similar devices to prevent maintenance-induced events leading to ground vehicle accidents or loss of air vehicles.
		MC-12	All plumbing and connectors containing liquids should be meniscus-free.
		PERS-01	Group man-machine interfaces manifold-style to enable connect/disconnect in a single action.
		PERS-02	Include an integral, highly visible indicator in a man-machine interface connector to denote connector is seated and locked.
		PERS-03	Design interface connectors so that a distinct action is required by an individual to effect a disconnect. (Excludes airframe-to-ejection seat personnel interfaces.)
		PERS-04	Interfaces should contain an emergency release mechanism that can be activated by rescue personnel with a 95 percentile gloved hand.
		PERS-05	Design emergency interface release mechanisms to be clearly visible under all types of lighting situations.
		SI-03	Parts and assemblies of a given model product or of models of a product in the same series should be interchangeable or replaceable.

Guidelines by Category (Cont'd)

Category No.	Category Title	Guideline No.	Guideline
3.12	Low Observable Technologies		
		BIT-16	Critical voltages should be visually monitored by sending the voltage signals to visible LEDs.
		CREW-08	Data storage media containers and modules should be capable of chemical and biological decontamination processes.
		ENG-47	Design the engine, including all accessories, plumbing, wiring, ducts, and mechanisms, to meet the same environmental protection and compatibility requirements as the host vehicle.
		ENV-01	Materials, treatments, coatings, finishes should be compatible with all anti-ice and de-ice fluids, chemical and biological decontamination fluids, washing and cleaning fluids, and all vehicle subsystem fluids.
		ENV-02	There should be no top coat or treatment deterioration throughout the standard temperature and humidity spectrum.
		ENV-03	For airborne vehicles, the finishes should be durable against rain, hail, and dynamic erosion throughout the flight envelope.
		ENV-04	For airborne and ground vehicles, the finishes should be durable against sand erosion throughout all surface wind speeds experienced in arid or desert geographical locations.
		EXH-01	Treatments required for engine hot sections and exhaust areas should not require scheduled removals for the purposes of recoating.
		EXH-02	High temperature exhaust patterns should flow away from or be directed away from treated surrounding structure, coatings, or finishes.
		IN(V)-08	Incorporate an inlet closure door sealing concept that prevents entry of fluid, dust, or sand across the entire airborne and ground environment spectrum.
		IN-01	Low Observable (LO) engine face frames should be within 10 inches of the first stage fan or compressor blades.
		IN-02	Openings throughout the engine face frame should be sufficient to perform a 100% FOD inspection of the engine face.
		IN-03	Openings throughout the engine face frame should be sufficient to permit minor blending or repair of FOD without removing the engine.
		IN-04	For frames not integral with the engine, frame removal should be achievable from the engine cavity.
		IN-05	Both integral and remote engine front frames should be interchangeable.
		IN-06	Front frame anti-ice and de-ice provisions should give preference to engine hot bleed air.
		LO-01	Use LO compatible gap fillers for manufactured gaps in lieu of tape and butter (surface coating compound).
		LO-02	Avoid scheduled forced inspections or replacement of materials, coatings, or finishes solely to protect either the reliability or the signature.
		LO-03	Equipment and support structure requiring shrouds to reduce radar returns should not cause increases in equipment service/repair time.
		LO-04	Infrequently-accessed structural doors and panels incorporating special coatings or conductive paints should contain provisions for prying the door or panel clear of moldline with standard screwdriver without damage.
		LO-05	Do not locate flush mounted LO screens for auxiliary air inlets and exits in walkway areas unless durability has been proven.
		MATL-01	A high degree of durability should be maintained for a minimum distance of 36 inches forward of the inflight refueling receptacle.
		MATL-02	Cosmetic type repairs should not exceed 1 hour including cure or drying times.
		MATL-03	Cosmetic and vehicle repair material shelf life should not be less than 24 months.
		MATL-04	Cosmetic and vehicle repair materials should be non-proprietary and non-single source.
		MATL-05	Cosmetic and vehicle repair materials should not require refrigeration or special facilities or atmospheres for storage.
		MATL-06	Repair criteria, repairs, and instructions should not be classified.
		MATL-07	All cosmetic touch-up and repair materials should be environmentally safe.
		MATL-08	Repairs (other than major depot repair) should not require autoclave type facilities.
		MATL-09	A high degree of durability should be achieved across all walkway areas on the top surfaces of all vehicles up to and including 95 percentile personnel.
		MATL-10	Coatings and finishes should be durable against the effects of missile gases, velocities, and particles emanating from the missile motor.

Guidelines by Category (Cont'd)

Category No.	Category Title	Guideline No.	Guideline		
3.12	Low Observable Technologies	MATL-11	Coatings and finishes should be durable against the effects of gun gases, projectile shock waves, and brass particles emanating from the projectile seal rings.		
		MATL-12	Leading edge materials and coatings should be durable against fragments from frangible gun port plugs.		
		MATL-13	Special handling or shipping requirements of repair materials should be avoided.		
		MATL-14	Leading edges, including chimes, containing or constructed of radar absorbing materials, should be interchangeable to reduce vehicle downtime and simplify repairs.		
		MATL-15	Doors and panels containing blade seals used for signature reduction should be interchangeable or contain interchangeable blade seals. Deviation is acceptable where repairs can be accomplished on the vehicle in a time equal to or less than door or seal remove and replace time.		
		PYRO-34	Weapon bay door seals should be bonded or attached to door structure to minimize induced seal damage during weapon or store loading.		
		SIMP-01	Location and design of all exterior lights should not require protective covers in ground environments.		
		SIMP-02	Landing and taxi lights should be mounted on landing gear struts or doors to eliminate separate compartments, doors, and retraction/extension mechanisms.		
		WBAY-01	Equipment bays and compartments should not require installation of special cavity fillers when equipment is not installed.		
		WBAY-04	The gap treatment should be a permanent installation on the pylon, wing, or both, not a separate seal.		
		WBAY-05	Gap treatment should not interfere with or be damaged by existing pylon handling support equipment.		
		WBAY-11	Gap seal should match pylon and wing/fuselage surface impedance.		
		WBAY-17	Special coatings or conductive paints on pylons, launchers, racks, launchers, tanks, pods, etc. should have the durability to withstand contact with support stands/cradles during storage.		
		WBAY-19	Frangible gun ports should take preference over mechanized gun port doors.		
		WBAY-20	Gun plugs required solely to maintain a given signature level should be capable of on-board stowage for use only when a threat requires their presence.		
		WBAY-21	Coatings and finishes in the area of gun barrels should be durable to withstand the effect of exiting projectile shockwaves.		
		WBAY-22	The proximity of the gun blast deflector to structure should not require reliance on high-temperature paints or coatings to protect the structure.		
		WIND-14	Exterior lights should permit simple and rapid bulb replacement without disturbing LO treatments.		
		WIND-16	Lens shape should enhance LO capability to reduce need, care, and expense for special coatings.		
		A-13	Two-sided or two-surfaced access should not be required for access to equipment interfaces and hardpoints. The term two-sided infers top/bottom, left/right, front/back, or combinations thereof.		
		3.13	System Support	A-14	Do not locate nutplates or gang channels in inaccessible areas that would require extensive disassembly or equipment removal to gain access.
				AA&S-03	Closure and sealing of cavities, compartments, and wells for retractable antennas should be maintained when antennas are not installed without need for ancillary measures or equipment.
AA&S-04	LO antennas should be designed to be tolerant of accumulations of grime or dirt without degrading performance or biasing the BIT/fault isolate performance.				
ARM-04	No single weapon/store mounted on a transporter should intrude into the service/turnaround envelope of another station.				
BIT-16	Critical voltages should be visually monitored by sending the voltage signals to visible LEDs.				
BIT-20	The BIT should be mechanized so that when a piece of equipment is not installed in a subsystem or the product, a failure will not be indicated.				
BIT-26	Locate routinely used test points so they are accessible without removing or disassembling other equipment				
BIT-27	Periodic and initiated BIT should detect at least 98% of all failures and isolate a minimum 99% of those failures detected to a single LRU or WRA.				
BIT-28	Design BIT to have the same level of EMI protection as the system or equipment being monitored.				

Guidelines by Category (Cont'd)

Category No.	Category Title	Guideline No.	Guideline
3.13	System Support	CARGO-01	<p>Ground vehicles with storage bays or compartments accessible from outside the vehicle should:</p> <ul style="list-style-type: none"> - Have the door sill located no lower than knee height to accommodate a wide range of percentiles while standing. - Ensure door handles are flush with outer surface to protect personnel. - Contain goose neck hinges to protect the hinge from the elements. - Contain peripheral door seals that will protect against blowing sand entry at 50 mph. - Ensure door can be opened with transport tie downs installed. - Ensure door opening envelope does not intrude into the opening envelope of an adjacent door. - Contain simple sheet metal hold-open spring or mechanism. - Ensure floor of bay or compartment is flush with sill to simplify cleanout and drainage. - Ensure door unlocking and opening mechanism can be actuated by a 95 percentile male hand while wearing arctic gloves. - Contain 15 percent added volume for density growth.
		CARGO-02	<p>Ground vehicles with small exterior storage bays or compartments containing emergency equipment or supplies should:</p> <ul style="list-style-type: none"> - Be located at chest height of the 50 percentile male. - Contain unlatching mechanisms activated by pushing inward on the door. - Meet all other generic bay and compartment requirements.
		CBR-01	<p>Orient all vehicle liquid servicing fittings to ensure fluids will not come in contact with protective garb during connect/disconnect activities.</p>
		CBR-02	<p>Ensure vehicle overboard passive liquid drains are clearly marked or visible to enable personnel to remain clear of area.</p>
		CREW-06	<p>Film magazines, tapes, and removable modules should permit considerable handling without reliance on special support equipment protection.</p>
		CREW-07	<p>Electronic and photosensitive storage media should withstand the adverse environment created by ground, flightline, or shipboard electromagnetic fields and light sources.</p>
		CREW-08	<p>Data storage media containers and modules should be capable of chemical and biological decontamination processes.</p>
		CREW-09	<p>Crew and operator station cassettes or magazines should be capable of being removed and installed with one hand while the operator or air crew is seated and strapped in.</p>
		CREW-12	<p>Requirements for boresighting should not be part of the design or integration.</p>
		EC-21	<p>Locate connectors far enough apart so that they meet specified requirements.</p>
		EC-22	<p>All connectors should be keyed differently with aligning pins that extend beyond the electrical pins. Connector pins and sockets should engage after key position is entered.</p>
		EC-23	<p>Design connectors so that plugs are cold and receptacles are hot.</p>
		EC-24	<p>Use electrical connectors that incorporate alignment key-ways to reduce incidents of damage due to improper engagement.</p>
		EC-25	<p>Use positive locking, quick disconnect electrical connectors to save man-hours, prevent foreign object damage (FOD) and decrease the chance of personal injury.</p>
		EC-26	<p>Avoid using identical electrical connectors in adjacent areas.</p>
		ECS-11	<p>Design air inlets, outlets, and exhausts to be accessible without reliance on ladders or work stands for ease of installing protective plugs or covers.</p>
		ECS-12	<p>Design air inlets, outlets, and exhausts with screens to prevent bird or rodent entry.</p>
		ECS-24	<p>System design and integration and technology application should be such that requirements for torque is not required.</p>
		FUEL-01	<p>Locate fuel vent and dump masts to ensure exiting fuel will be clear of servicing, loading, arming and safing areas for all types of ground and airborne vehicles.</p>
		FUEL-06	<p>Where maintaining a minimum angle of 90 degrees is not possible, sufficient depth, width, and height should be maintained to provide tool clearances for all tools used in the manufacturing processes and in the operational field repair environment.</p>
		HOOK-01	<p>Locate, orient, and mechanize Nose Gear Tow/Nose Gear Holdback (NGT/NGH) mechanisms so they do not interfere with the hookup and attachment of standard towbars.</p>

Guidelines by Category (Cont'd)

Category No.	Category Title	Guideline No.	Guideline
3.13	System Support	HOOK-02	Design NGT/NGH mechanisms with integral provisions to visually indicate correct hookup/attachment. The indication must be visible during all day and night carrier operations.
		HOOK-03	NGT/NGH mechanisms should not require scheduled visual or NDI type inspections.
		HYD-01	For military combat vehicles having two or more hydraulic power systems, provide a minimum 30-inch spacing between ground power and servicing interfaces to ensure: <ul style="list-style-type: none"> - Design flexibility in locating and arranging equipment in high-density vehicles such as fighters and helicopters, - Work area separation to enable concurrent service/maintenance on systems, - Systems vulnerability enhancement, - Reduction in turn-around elapsed time due to concurrent servicing capability.
		HYD-04	For vehicles containing two or more systems with different fluids, use different service fittings and different ground power interfaces for each fluid type.
		IN(V)-07	Ensure that no ground safety pins or streamers are used forward of the inlet or within a 3-foot radius aft of the inlet.
		LG-01	Bearings, excluding wheel bearings, should not require lubrication during the expected life of the air vehicle airframe.
		LG-02	Hardpoints for attachment of landing gear trunnions should be capable of carrying all induced gear loads for the life of the airframe.
		LG-03	Hardpoints for attachment for landing gear trunnions should not be machined as an integral part of the airframe structure when normal design sink rates over 25 feet per second are required.
		LG-04	Do not use Beryllium and Beryllium base alloys in any location subject to wear or corrosive atmospheres or in installations where machining may be required.
		LG-05	All bolts or similar threaded means used as adjustable stops should be positively retained in the adjusted reference without reliance on jam nuts, cotter pins, or safety wire.
		LG-13	No special tools or equipment should be required to maintain/service struts in normal day-to-day operational environments.
		LG-16	No portion of the landing gear rigging process should require support equipment type templates, gauges, or tools. Indexes, reference points, etc., should be an integral part of the landing gear/airframe design.
		LG-17	Hydraulic, pneumatic, or electrical actuators associated with landing gear systems should not require adjustment or rigging once installed in the air vehicle. Spare units should be rigged at the time of manufacture or overhaul.
		LG-18	Landing gear ground safety down locks should be an integral part of the overall design. Use or reliance on loose pins (support equipment) should be avoided.
		LG-20	Special locks and pins used solely for landing gear ground maintenance safety should be used only in those cases substantiated by cost effectiveness analysis.
		LG-23	Design strut fittings for servicing nitrogen or hydraulic fluid to be easily accessible and adjacent to the appropriate strut pressure gage.
		LG-24	Design struts so they can be serviced with clean, dry air in lieu of nitrogen during deployments without affecting the overall reliability.
		LG-41	No more than 1 jack should be required to change any singular wheel/tire assembly.
		LG-42	Landing gear struts should contain built-in, dial type pressure gages.
		LG-43	Incorporate low pressure warning sensors in nose landing gear whenever under-servicing of the gear could result in failure to rotate aircraft during takeoff. This feature will eliminate many aborted take-offs, many of which result in blown tires or aircraft leaving the runway.
		MC-11	No subsystem plumbing, equipment or wiring should use a tank, cell, or compartment containing liquids as a means for routing or penetration simplicity during manufacture.
		MC-12	All plumbing and connectors containing liquids should be meniscus-free.
		MP-01	Avoid the use of epoxies to mount parts on repairable modules because they make repair extremely difficult.
		MP-02	Use a unique identification (ID) resistor incorporated in each system module to verify that the proper module is mounted on ATE.

Guidelines by Category (Cont'd)

Category No.	Category Title	Guideline No.	Guideline
3.13	System Support		
		MP-03	Design modules so that lengthy warm-up times, special coding and air purity levels, and similar constraints are not necessary.
		OXY-01	System should contain automatic BIT for warning indicators to eliminate dedicated test switches and/or test requirements.
		P-06	Access door and panel devices used to support door in opened position should meet the following criteria: - for airborne vehicles, design for 60 knot gust loads (or equivalent jet blast loads) - for ground vehicles, design for 50 mph gust loads
		P-07	Hinged access doors and panels capable of remaining in the opened position should not have sharp edges or corners.
		P-08	Removable access door and panel fasteners should be of identical grip length and diameter.
		P-11	Access doors and panels should be interchangeable as justified by operation and support costs or life cycle costs.
		PYRO-11	Design electrical/electronic "safe/arm" systems to eliminate the need for mechanical type system interrupt devices.
		PYRO-13	Container design for shipping, handling, and storing weapons, flares, chaff, and similar devices should not require special atmospheres.
		PYRO-19	Locate built-in grounding receptacles clear of weapon approach and loading envelopes.
		PYRO-24	Ammo loader interface should not be less than 30" nor more than 50" above the ground to ensure loading can be accomplished by a wide range of percentiles wearing chemical or biological protective gear.
		PYRO-26	Do not locate ammunition loader interfaces close to inlets, exhausts, fuel dumps and drains, antennas, sensors, lights, or hazardous protrusions.
		PYRO-27	Incorporate integral hoisting provisions at each weapon/store station to enable direct lift from the container or carrier to the attachment hardpoints.
		PYRO-41	Weapon or store handling and transportation equipment should be compatible with rough terrain and capable of 25 mph towing speeds minimum.
		PYRO-42	In weapons carriage design and integration, avoid dependence of on-board high pressure nitrogen.
		PYRO-46	Design pylons, launchers, and ejector racks so that weapon loading, servicing, and reconfigurations can be accomplished using standard hand tools.
		PYRO-47	Installation design of ejectors, launchers, racks, and associated hardware interfaces should avoid reliance on torque wrenches.
		SAFE-06	Wing fold locking mechanisms should provide a moldline indication that locks are in place. Loose or separate safety devices that must be installed manually should be avoided.
		SAFE-07	Landing and alighting gear design should ensure downlocks are integral to the mechanisms and provide a clear indication of position status. This guideline also applies to tail hooks.
		SAFE-08	A single lever safety should, when positioned, safe the entire escape/ejection system. Use of the single lever to "arm" should require two hands.
		SAFE-09	Safing the canopy jettison system should be accomplished through the same lever device used to safe the ejection seat.
		SAFE-10	The single lever safing concept should apply to day-to-day flight operations. Individual or multiple safety pins for pyrotechnic devices should only be required during escape system maintenance.
		SE-01	Wheel chocks for all types of ground and airborne vehicles should contain the following features: - Be nestable for low volume during storage or transport - Be manufactured from corrosion-resistant materials - Be releasable from tire pinch - Be highly visible for day and night operations - Be impervious to all types of fluids used to service or maintain the vehicles - Be of light weight
		SE-02	Wheel chocks for airborne vehicles should also contain the following features: - Contain provisions for securing to ramp or flight decks - Contain provisions to secure chocks at wheels - Releasable/removable from outside of hot brake envelope - Contain provisions to enable chock to be used as a tire blowout device - Contain provisions to prevent skidding on snow or ice

Guidelines by Category (Cont'd)

Category No.	Category Title	Guideline No.	Guideline
3.13	System Support	SE-03	<p>Wheel chock design guideline discussion. Wheel chocks have historically contributed to numerous accidents and incidents across the entire design spectrum, yet have received the least design attention of any ground handling/support equipment. Directly and indirectly, poorly designed chocks have:</p> <ul style="list-style-type: none"> - Resulted in numerous "jumping the chocks" incidents due to improper use or positioning, and improper chock sizing for the tire size/power application. Some instances result in destruction of the aircraft. - Resulted in vehicle movement/sliding across wet, snowy and icy surfaces as a result of improper grip. - Resulted in unwarranted tire damage and/or engine FOD. - Resulted in tertiary damage to other vehicles or ground equipment as a result of being blown about by jet/propeller blast. - Damaged surfaces due to temporary placement of chocks on vehicle surfaces during vehicle movement. - Resulted in personnel sliver/s abrasions (wooden chocks) and cuts (metal chocks) even when chocks were in decent useable condition. - Resulted in varied personnel ground accidents during attempts to use chocks as a temporary work stand. - Lost aircraft "over the side" on carriers. <p>Gun port covers or plugs should be lightweight, 100% effective, and easy to install or store.</p> <p>The geometric aspects of simple maintenance stands, ladders, and work platforms should enable high density stacking for storage and mobility deployments.</p> <p>Non-metallic materials should take preference over metals to enable simple manufacturing and repair by bonding in lieu of weldments and/or mechanical fasteners.</p> <p>The design construction concept and material selection for support equipment structure should not rely or depend upon the use of scheduled maintenance, NDI, or NDT to protect the durability or integrity of the equipment in the operational environment.</p> <p>Support legs, posts, arms for ladders and workstands should contain integral non-skid devices for safe use on ice or snow.</p> <p>Ladders and workstands used in close proximity to air and ground vehicles should contain effective buffers to protect finishes and treatments.</p> <p>Protective finishes and coatings should meet the same ground environmental criteria as defined for air and ground vehicles.</p> <p>Avoid reliance on mechanical fasteners solely to facilitate manufacturing.</p> <p>Design personnel seats and padding materials, including the covers and fillers, so they are incapable of creating or emitting toxic fumes or dense smoke when subjected to fire.</p> <p>Parts and assemblies of a given model product or of models of a product in the same series should be interchangeable or replaceable.</p> <p>Provide crew stations, crew compartments, and operator areas containing dinghies as emergency equipment with a suitable tool for puncturing or cutting the dinghy in the event of inadvertent inflation. Locate the tool so that access is assured during dinghy inflation.</p> <p>Gap treatment should not interfere with or be damaged by existing pylon handling support equipment.</p> <p>Seal equipment bays and compartments against the environmental elements including all types of servicing fluids used for the vehicle, all types of anti-ice and de-ice fluids, and all types of fluids used for chemical, biological, or nuclear decontamination</p> <p>Equipment bay and compartment structure should be bonded, co-cured, welded, machined, or combinations thereof to eliminate or minimize the use of mechanical fasteners.</p> <p>All equipment bay and compartment structural flanges and stiffeners should be external to the compartment to maximize the volume available for equipment installation and arrangement.</p> <p>Use stiffening beads in lieu of flanges to the maximum extent to enhance compartment volume and simplify repairs.</p> <p>Stiffening beads should have the convex surface toward the compartment to eliminate fluid traps.</p> <p>Keep all machined compartment frames, webs, and closure panels to a constant thickness (e.g., not stepped or tapered) to ease simplicity of fluid or electrical penetrations and ease and simplicity of structural repair.</p>
		SE-04	
		SE-05	
		SE-06	
		SE-07	
		SE-08	
		SE-09	
		SE-10	
		SE-11	
		SEAT-01	
		SI-03	
		SURV-02	
3.13.01	Support and Ground Handling Equipment	WBAY-05 A-01	
		A-02	
		A-03	
		A-04	
		A-05	

Guidelines by Category (Cont'd)

Category No.	Category Title	Guideline No.	Guideline
3.13.01	Support and Ground Handling Equipment	A-06	Hardpoints (structural attachment and load bearing areas) within a compartment to assist in equipment mounting or support should not be integral with the machined part. Hardpoints should be parasitic to enable quick repair in case of wear or damage in lieu of precise ream/bush repair typical of machined hardpoints.
		A-07	Paint equipment bay and compartment interiors a high gloss white to maximize lighting reflectivity, visibility, and rapid leak detection capability.
		A-08	Plumbing penetrations into a compartment should not be on a vertical axis due to difficulty in making or breaking vertically-oriented connections. When compartment access is from the bottom, vertically-oriented connections can allow fluid to leak onto the maintainer. When access is from the top, such connections can allow foreign matter to enter the line. Use horizontal penetrations whenever possible.
		A-09	Any heat or temperature sensitive structure within a compartment should contain heat-sensitive tape or appropriate heat sensor for easy indication of over-temperature excursions.
		A-10	Provide a sufficient number of compartment fluid drains to ensure fluid drainage for varying aircraft static attitudes and varying terrain slopes for ground vehicles.
		A-11	Locate compartment electrical penetrations close to the access opening for ease of sight, probing, repair, and to eliminate fluid soaking, wicking, or contamination.
		A-12	Locate compartment electrical penetrations far enough from the access opening to prevent damage resulting from improper (over-length) panel fasteners.
		A-15	Locate tie-down attachment points such that tie-down chains, straps, or cables do not prevent or restrict normal servicing, weapon loading, or safe/arm functions.
		A-16	Structural design should provide good access to corrosion-prone areas for inspection and treatment.
		A-17	All structural fasteners in an access door or panel should be of identical grip and diameter. In rare cases where this is not possible, fasteners of different grip must have different diameters to prevent a shorter fastener being substituted for the correct, longer fastener.
		A-18	Use transparent windows, quick-opening covers, or openings without any cover to permit quick visual inspections where needed.
		ACS-10	Ensure all diagnostic and prognostic logic, intelligence, and status type informational data are storable and viewable within the crew station.
		ACS-11	Provide crew station personnel with the capability to manually initiate selective BIT and interrogate the prognostics system without interrupting the full-time or periodic BIT routines.
		ARM-04	No single weapon/store mounted on a transporter should intrude into the service/turnaround envelope of another station.
		BIT-01	During design of the BIT, use worst-case stress analysis to ensure that any circuit failures induced by temperature extremes, tolerance build-up, power supply variations, and combinations thereof are identified.
		BIT-02	Ensure that BIT system thresholds are consistent with those across the system, subsystem, item, module, and piece-part levels to prevent excessive numbers of Cannot Duplicate (CND) and Retest OK (RTOK) events from occurring.
		BIT-03	The degree of BIT required or proposed should be based on the respective failure rates and the appropriate FMECA at all equipment indenture levels.
		BIT-04	Limit the amount of data that is recorded to a manageable size by: <ul style="list-style-type: none"> - Limiting the number of signals that are monitored - Limiting the maximum sampling rate - Reducing the time span over which data is accumulated - Restricting the type of data accumulated
		BIT-05	Incorporate testability design features as an integral part of equipment preliminary design process.
		BIT-16	Critical voltages should be visually monitored by sending the voltage signals to visible LEDs.
		BIT-20	The BIT should be mechanized so that when a piece of equipment is not installed in a subsystem or the product, a failure will not be indicated.
		BIT-21	The failure detection function should provide the equipment operator with a go/no-go indication of equipment readiness.

Guidelines by Category (Cont'd)

Category No.	Category Title	Guideline No.	Guideline
3.13.01	Support and Ground Handling Equipment		
		BIT-22	The BIT should be designed so that auxiliary test devices or external equipment are not needed for daily and other regular checks.
		BIT-23	Design BIT so it is initiated automatically upon equipment power-up.
		BIT-24	Test points should be functionally grouped together and clearly labeled for convenience and ease of maintenance.
		BIT-25	Equipment should not require manual probing to fault isolate.
		BIT-26	Locate routinely used test points so they are accessible without removing or disassembling other equipment
		BIT-27	Periodic and initiated BIT should detect at least 98% of all failures and isolate a minimum 99% of those failures detected to a single LRU or WRA.
		BIT-28	Design BIT to have the same level of EMI protection as the system or equipment being monitored.
		C-01	Avoid swivel type connectors and fittings for air, fuel, or hydraulic line interfaces due to their history of low reliability.
		C-02	Provide spacing between parallel plumbing runs so that in-line couplings can be replaced without removing lines or disconnecting any line support devices.
		CARGO-01	Ground vehicles with storage bays or compartments accessible from outside the vehicle should: <ul style="list-style-type: none"> - Have the door sill located no lower than knee height to accommodate a wide range of percentiles while standing. - Ensure door handles are flush with outer surface to protect personnel. - Contain goose neck hinges to protect the hinge from the elements. - Contain peripheral door seals that will protect against blowing sand entry at 50 mph. - Ensure door can be opened with transport tie downs installed. - Ensure door opening envelope does not intrude into the opening envelope of an adjacent door. - Contain simple sheet metal hold-open spring or mechanism. - Ensure floor of bay or compartment is flush with sill to simplify cleanout and drainage. - Ensure door unlocking and opening mechanism can be actuated by a 95 percentile male hand while wearing arctic gloves. - Contain 15 percent added volume for density growth.
		CARGO-02	Ground vehicles with small exterior storage bays or compartments containing emergency equipment or supplies should: <ul style="list-style-type: none"> - Be located at chest height of the 50 percentile male. - Contain unlatching mechanisms activated by pushing inward on the door. - Meet all other generic bay and compartment requirements.
		CC-01	Use fiber-optic technologies in preference to conventional interconnect concepts to reduce the number of interconnects/interfaces, reduce manufacturing and ownership costs, and significantly improve R&M.
		CC-02	Standardize connector and wire types to improve testability and logistic support. Keep the number of "different" standard connectors to a minimum. Use the same connector type keyed differently where possible.
		CC-03	Provide clearance around connectors for engagement/disengagement of cables and proper connector orientation under anticipated environmental conditions (e.g., bare hand of 50 percentile male in an enclosed or protected environment and a gloved hand of a 50 percentile male in an open or unprotected environment).
		CC-04	Use quick release cables and locate cables to make removal and replacement easy and to avoid having to remove one cable to gain access to another. Provide adequate space for cables, including sleeving and tie-downs, and adequate service loops for ease of assembly/disassembly
		CC-05	Orient and space connectors to allow a sufficient grip on the connector for cable or wire extraction without fear of using the wiring or cable for additional leverage.
		CC-06	Label, and where possible color code, each wire in a harness or cable to facilitate tracking from origin to termination. Each wire, cable, and coax-to-connector interface should be provided with a source of identification to aid in trouble shooting, repair, or modification. Marking the cable designator on the cable along with bar codes is also recommended.
		CC-07	Do not manufacture or dress connectors containing more than 25 wires or cables as a single integrated harness. Group the wires or cables into runs of no more than 25 wires or cables each. In addition to making trouble shooting and repair easier, this approach help avoid large bend radii, thereby simplifying routing, packaging, and stowage.
		CC-08	Standardize connector pin assignments for power, ground, and other frequently used signals.

Guidelines by Category (Cont'd)

Category No.	Category Title	Guideline No.	Guideline
3.13.01	Support and Ground Handling Equipment	CC-09	Locate LRU/subsystem critical nodes (and or test points) so they are accessible from a connector to prevent the need for internal LRU probing or access.
		CC-10	Avoid hidden cables. Visually inspecting and tracing all assembly cables rather than having hidden cables (such as behind other cables or even LRUs) allows for a quick system and cable integrity check which aids in overall system integrity and debug. This also implies quick access for manipulative actions.
		CC-11	Orient spare wires and cable pigtails along the outer diameter or periphery of connectors to make access easier.
		CC-12	Build up and assemble straight and angle connector shells or back shells in a manner that ensures that wire or cable strain or wear is not possible.
		CO-01	Design automated systems and programs with provisions to enable "stop test" and "resume" without the need to cycle back or repeat the entire test.
		CO-02	In the event of program loss or hang-up, automated systems and programs should have provisions for reverting to manual test and operation.
		CO-03	Use a test connector to provide test and maintenance bus access to all system and subsystem faults.
		CO-04	Design systems and subsystems so that ATE can be used to access, read, and control internal components in concert with the test or checkout program.
		CO-05	Avoid the need for costly adapters for signal communications between system, subsystems, line replaceable units (LRUs) or Weapon Replaceable Assemblies (WRAs), and ATE.
		CONT-01	Control rods should use Boyd or impedance type bolts (or equivalent) to eliminate the need for cotter pins or safety wire.
		CONT-02	Do not use metal control cables for vehicles that will operate in salt water or salt air environments.
		CONT-03	Use control rods rather than control cables for non-complex applications and non-complex routing within the vehicle.
		CONT-04	Use control cables rather than control rods for most complex applications.
		CONT-05	Route cables so that 100 percent of a cable will be viewable for inspection.
		CONT-06	Design all pulleys and brackets associated with cable installations so they are accessible by a 75 percentile male hand.
		CREW-12	Requirements for boresighting should not be part of the design or integration.
		EC-01	A threaded electrical connector should contain integral locking mechanisms and visual indications that the connector is properly seated and locked.
		EC-02	An electrical connector requiring less than one full turn to connect or disconnect should contain integral locking mechanisms and visual indications that the connector is properly seated and locked.
		EC-03	A push-pull electrical connector (excluding rack-and-panel type) should contain integral locking features and visual indication that the connector is properly seated and locked.
		EC-04	All electrical connectors should be keyed or asymmetrically shaped to ensure proper alignment.
		EC-05	All electrical connectors should contain scoop-proof shells to ensure pin damage will not occur prior to engaging key way.
		EC-06	All electrical connectors should be corrosion resistant to reduce or eliminate the need for scheduled inspections or corrosion prevention measures.
		EC-07	Avoid using electrical connectors requiring any type or form of soldering.
		EC-08	Locate and position electrical connectors such that all pin identification for either half can be easily seen.
		EC-09	Electrical connectors selected for critical applications on ground vehicles should be both accessible and capable of being connected/disconnected by a fifty percentile gloved male hand.
		EC-11	Avoid connectors requiring potting as a method for environmental protection due to lengthy repair time and tendency for potting compound reversion.
		EC-12	Electrical penetrations into a compartment should not be on a vertical axis to ensure foreign matter does not enter connector.
		EC-14	Scoop proof connectors should be used throughout unless their use would require an increase in the volume of the aircraft, in which case deviations will be considered on an individual basis.

Guidelines by Category (Cont'd)

Category No.	Category Title	Guideline No.	Guideline
3.13.01	Support and Ground Handling Equipment	EC-15	The removal or replacement of electronic equipment should not require the removal of any other piece of equipment or armament.
		EC-16	Select connectors so that contacts on the "live" or "hot" side of the connection are socket type rather than pin type to minimize personnel hazard and to prevent accidental shorting of live circuits.
		EC-17	Whenever possible, use self-locking connector plugs of a type not requiring safety wire.
		EC-18	All electric connectors should be environment resistant.
		EC-19	Connectors containing fiber optic contacts should, whenever possible, be mounted on a vertical surface to prevent particle and fluid contamination.
		EC-20	Use quick disconnect connectors where allowed and identify all pins on each connector.
		EC-21	Locate connectors far enough apart so that they meet specified requirements.
		EC-22	All connectors should be keyed differently with aligning pins that extend beyond the electrical pins. Connector pins and sockets should engage after key position is entered.
		EC-23	Design connectors so that plugs are cold and receptacles are hot.
		EC-24	Use electrical connectors that incorporate alignment key-ways to reduce incidents of damage due to improper engagement.
		EC-25	Use positive locking, quick disconnect electrical connectors to save man-hours, prevent foreign object damage (FOD) and decrease the chance of personal injury.
		EC-26	Avoid using identical electrical connectors in adjacent areas.
		ECS-11	Design air inlets, outlets, and exhausts to be accessible without reliance on ladders or work stands for ease of installing protective plugs or covers.
		ECS-12	Design air inlets, outlets, and exhausts with screens to prevent bird or rodent entry.
		ECS-24	System design and integration and technology application should be such that requirements for torque is not required.
		EG-01	Design feedback loops so that the loop can be broken during test to ensure that faults do not propagate to the point where they cannot be isolated.
		EG-02	Avoid using external feedback loops requiring complex circuitry to simulate feedback I/Os.
		EG-03	In rare instances when complex external feedback loops cannot be avoided, incorporate simple interruptible control points.
		EG-04	Avoid long sequences of vectors to initialize or alter device outputs to minimize potential testability problems.
		EG-05	Avoid the need to have test equipment generate complex, phased or time related signals.
		EG-06	Test points should be located on all circuit nodes that are useful in determining the module's health.
		EG-07	Test points should be designed so that functional circuitry cannot be damaged or degraded due to the routing or accidental shorting of a signal at a test point. Some type of test point isolation technique should be used (buffers, isolator, etc.).
		EG-08	Test points should be easily accessed and clearly marked.
		EG-10	Design redundant circuits to be independently testable to ensure errors are not masked.
		EG-11	To improve the probability of fault detection, avoid shorting signals together to achieve a specific test function or condition.
		EG-12	Incorporate concept for partitioning module functions to simplify test equipment or eliminate the need for ancillary test equipment.
		EG-13	Design oscillators or clocks that are resident on the module to be replaceable by a signal from a connector to avoid the need to synchronize ATE to on-board signals.
		ENG(G)-01	Provide access to all engine mounts for ground vehicles so that hoisting or crawling under the vehicle is not required.
		ENG(G)-02	Use torque-limiting bolts or torque washers as engine mount attaching hardware to eliminate the need for torque wrenches.
		ENG(G)-03	Design hard points for hoisting or positioning the engine during installation and removal to be integral to the engine and capable of hoisting and supporting a fully-built-up engine package.
		ENG(G)-04	Do not use downward engine removal concepts that require jacking or hoisting of the ground vehicle.

Guidelines by Category (Cont'd)

Category No.	Category Title	Guideline No.	Guideline
3.13.01	Support and Ground Handling Equipment	ENG(G)-05	Use concepts for removing ground vehicle engines from the front, rear, or side rather than from overhead (using hoisting).
		ENG(G)-06	The distance between the engine and firewall should ensure the access envelopes to lines, fittings, wiring, and adjustments will accommodate the 75 percentile male hand.
		ENG(G)-07	The distance between the cooling fan and radiator core should ensure that access envelopes will not require removal of the core.
		ENG(G)-08	The interface of the engine assembly to the engine compartment and structure should be designed to ensure all spark plugs, glow-plugs, and igniters can be replaced within 30 minutes elapsed time.
		ENG(G)-09	Design all interfaces between the engine assembly and the host vehicle to be in full view of the maintainers and so that crawling under the vehicle is not required.
		ENG(G)-10	Design attaching hardware for all mechanical engine-to-vehicle interfaces to be captive and with integral safeties.
		ENG(G)-11	Use "torq-set" type clamps or equivalent in all cooling system hose interfaces to eliminate torque wrenches and the potential for error.
		ENG(G)-12	Provide a clear and viewable access envelope to fuel and oil filters.
		ENG(G)-13	Locate fuel filters to ensure no safety hazard will exist due to residual fuel during filter change.
		ENG(G)-14	Access envelopes to fuel and oil filters should not be in close proximity to exhaust manifolds or cooling system return lines.
		ENG(G)-15	Any single drive belt (excluding timing belts) should be capable of replacement within 30 minutes elapsed time
		ENG(G)-18	Incorporate appropriate sensors to enhance the diagnostic and prognostic capabilities for the following: <ul style="list-style-type: none"> - Oil temperature - Fuel filter bypass - Oil pressure - Coolant pressure - Oil filter bypass - Coolant level - Oil cooler bypass valve position - Coolant temperature - Oil level - Vibration pickups - Oil return line particle count - Chip detector
		ENG(G)-19	Paint engine compartments gloss white to enhance light reflectivity and enhance fluid leak detection.
		ENG(G)-20	Design all firewall fittings, connectors, and penetrations to be fully viewable and directly accessible to the maintainers.
		ENG-01	All facets of engine design should take advantage of Electrostatic Engine Monitoring Systems (EEMS) and Inductive Debris Monitoring (IDM) toward achievement of on-condition maintenance and engine health monitoring.
		ENG-02	Each different component of rotating machinery should contain different tracer elements to enhance EEMS and IDM isolation and tracking of wear.
		ENG-03	Digital electronic controls, fully automatic digital electronic controls, and similar concepts should contain the highest degree of BIT and diagnostics commensurate with affordability, operation and maintenance, and life cycle costs as appropriate.
		ENG-04	The engine and engine-mounted gear box should have individual oil supplies to ensure wear or failures in one will not contaminate or fail the other.
		ENG-05	All engine-mounted air and fluid lines should be located next to the fan case, engine case, or full-length fan duct to ensure quick and simple replacement of accessories and components.
		ENG-06	All other engine surfaces and engine-mounted accessory surfaces should be free of pockets, channels, and bathtubs that could trap and retain fluids.
		ENG-10	On multi-engine air vehicles, the airframe-to-engine interfaces should be in identical positions or orientations for each engine cavity.
		ENG-12	All engine-mounted accessories must be capable of being removed and installed through the available airframe access openings.
		ENG-13	Engine oil systems should contain on-board spectrometric oil analysis devices located on the engine.
		ENG-15	Engine removal for aircraft intended to be operated off carriers should be accomplished within the shadow of the aircraft.

MIL-HDBK-470A

APPENDIX C

Guidelines by Category (Cont'd)

Category No.	Category Title	Guideline No.	Guideline
3.13.01	Support and Ground Handling Equipment	ENG-16	Aircraft jacking should not be required for engine removal.
		ENG-17	Aft engine removal should be an acceptable alternative for USAF aircraft.
		ENG-18	For either downward or aft engine removal, it should be possible to maintain control of the engine on all axis during the entire removal and installation process.
		ENG-19	The minimum clearance between engine and airframe should be 1 inch, including removal and installation.
		ENG-23	All engine borescope provisions should be accessible with the engine installed and hooked up.
		ENG-31	No rigging or calibration should be required subsequent to replacement of any engine-mounted component.
		ENG-32	Design the engine fuel controls and electronic controllers so that no manual fuel grade adjustments are required.
		ENG-33	Engine access doors and panels and their integral support struts should be capable of withstanding 60 MPH winds in the opened position.
		ENG-37	Gravity type servicing fittings, covers, and caps should have integral locking features, openable by hand, and contain a cable or chain to prevent loss or dropping.
		ENG-38	The characteristics of engine-to-vehicle interfaces coupled with the capabilities of electronic engine controls, should negate the necessity for making any type of engine rigging including maximum power, idle, and idle cut-off.
		ENG-45	Provide remote servicing points accessible from the ground to service engine accessories mounted on top of the engine (e.g., oil tanks, gear boxes, generators, etc.) to eliminate climbing upon or atop the host vehicle.
		ENG-52	Incorporate provisions to enable very slow rotation of the fan, compressor, and turbine during borescope inspections.
		ENG-53	Design magnetic chip detectors to ensure that oil shut-off will occur as the detector is being removed for visual inspection.
		ENG-54	Incorporate provisions for fuzz burn-off: in magnetic chip detectors.
		ENV-01	Materials, treatments, coatings, finishes should be compatible with all anti-ice and de-ice fluids, chemical and biological decontamination fluids, washing and cleaning fluids, and all vehicle subsystem fluids.
		ENV-02	There should be no top coat or treatment deterioration throughout the standard temperature and humidity spectrum.
		ENV-04	For airborne and ground vehicles, the finishes should be durable against sand erosion throughout all surface wind speeds experienced in arid or desert geographical locations.
		ENV-06	For ground vehicles, the finishes should be compatible with and durable against all rain, hail, sleet, snow, and ice conditions experienced in all intended operational environments.
		EXH-01	Treatments required for engine hot sections and exhaust areas should not require scheduled removals for the purposes of recoating.
		EXH-02	High temperature exhaust patterns should flow away from or be directed away from treated surrounding structure, coatings, or finishes.
		EXT-01	Locate Tanks, Pods, Containers, and Devices (TPCD's) so they do not block or restrict access to existing vehicle access areas or access approach envelopes.
		EXT-03	Design TPCD's to be fully compatible with the existing vehicle built-in hoisting provisions and locking devices.
		EXT-04	Design TPCD's used for fuel containment so that post-installation operational tests or checks are not required.
		EXT-06	Design cargo TPCD's to ensure all cargo and equipment can be downloaded and uploaded with the TPCD installed on the host vehicle.
		F-01	Use blind fasteners only where absolutely necessary or where considerable cost can be saved.
		F-02	Minimize access fasteners while making them quick release, easily removed and replaced, and captive.
		F-03	Choose fasteners based on the requirement to operate by hand or with common hand tools rather than special tools.
		F-04	Whenever possible, incorporate barrel type fasteners as opposed to hi-torque fasteners. Failure of Hi-torque fasteners due to stripping are common and a source of potential foreign object damage (FOD).
		FI-01	Design each FI test to be independent of all other tests.
		FI-02	Design FI initiation to be subordinate to the higher priority predecessor tests.
		FI-03	Design each test so that it can be terminated prior to completion and then re-initiated at its start point.

Guidelines by Category (Cont'd)

Category No.	Category Title	Guideline No.	Guideline
3.13.01	Support and Ground Handling Equipment	FI-04	Design the unit tests so that they can accommodate the following subsystem response modes: <ul style="list-style-type: none"> - Incorrect response - No response - Inconsistent response - Unexpected condition
		FI-05	Design all software so that it is structured by test priority. The test software should take advantage of both subroutine constructs for all message outputs and of failure dictionaries which identify the location of the most likely failed replaceable unit.
		FI-06	In an airborne avionics system, consider indicating mission critical faults on a pilots "head-up" display accompanied with an audible alarm, so that the pilot can easily check for critical system or mission threatening problems.
		FI-07	Ensure that system user manuals include instructions for faults not covered by BIT such as, system will not power up or system is being used in an incorrect environment such as, at the wrong altitude, etc.
		FI-08	Interlock the high power sections of systems and subsystems with visual/audible BIT to ensure safe system activation.
		FI-09	Design BIT to first conduct self-test for circuitry integrity before conducting system test.
		FI-10	Use clear text to report failures rather than alpha-numeric codes, lights, indicators, etc.
		FI-11	Locate BIT circuitry on the same level of the subsystem under test to simplify test and repair when it is removed from the main system.
		FUEL-01	Locate fuel vent and dump masts to ensure exiting fuel will be clear of servicing, loading, arming and safing areas for all types of ground and airborne vehicles.
		FUEL-06	Where maintaining a minimum angle of 90 degrees is not possible, sufficient depth, width, and height should be maintained to provide tool clearances for all tools used in the manufacturing processes and in the operational field repair environment.
		HOOK-01	Locate, orient, and mechanize Nose Gear Tow/Nose Gear Holdback (NGT/NGH) mechanisms so they do not interfere with the hookup and attachment of standard towbars.
		HOOK-02	Design NGT/NGH mechanisms with integral provisions to visually indicate correct hookup/attachment. The indication must be visible during all day and night carrier operations.
		HOOK-03	NGT/NGH mechanisms should not require scheduled visual or NDI type inspections.
		HYD-01	For military combat vehicles having two or more hydraulic power systems, provide a minimum 30-inch spacing between ground power and servicing interfaces to ensure: <ul style="list-style-type: none"> - Design flexibility in locating and arranging equipment in high-density vehicles such as fighters and helicopters, - Work area separation to enable concurrent service/maintenance on systems, - Systems vulnerability enhancement, - Reduction in turn-around elapsed time due to concurrent servicing capability.
		HYD-04	For vehicles containing two or more systems with different fluids, use different service fittings and different ground power interfaces for each fluid type.
		IN(V)-07	Ensure that no ground safety pins or streamers are used forward of the inlet or within a 3-foot radius aft of the inlet.
		LG-01	Bearings, excluding wheel bearings, should not require lubrication during the expected life of the air vehicle airframe.
		LG-02	Hardpoints for attachment of landing gear trunnions should be capable of carrying all induced gear loads for the life of the airframe.
		LG-03	Hardpoints for attachment for landing gear trunnions should not be machined as an integral part of the airframe structure when normal design sink rates over 25 feet per second are required.
		LG-04	Do not use Beryllium and Beryllium base alloys in any location subject to wear or corrosive atmospheres or in installations where machining may be required.
		LG-05	All bolts or similar threaded means used as adjustable stops should be positively retained in the adjusted reference without reliance on jam nuts, cotter pins, or safety wire.

Guidelines by Category (Cont'd)

Category No.	Category Title	Guideline No.	Guideline
3.13.01	Support and Ground Handling Equipment	LG-06	Design struts, attachments, and interfaces so they do not depend on scheduled visual inspections, non-destructive inspection (NDI), or non-destructive test (NDT) to ensure the reliability or integrity of the system in the operational environment.
		LG-07	No portion of the landing gear struts, drag braces, or interfaces should contain pockets or bathtubs that can trap or hold moisture. In rare instances where this is not possible, holes should be drilled as appropriate to prevent moisture/liquid accumulation.
		LG-08	Brackets, levers, links, rods, et al mounted on the struts should either be symmetrical to tolerate reverse installation or should be impossible to reverse.
		LG-09	Use coiled tubing in lieu of flex lines or hoses for hydraulic line routing from the airframe to the strut.
		LG-10	All wiring or coax mounted to a strut should have appropriate interface connectors to simplify strut removal and installation.
		LG-13	No special tools or equipment should be required to maintain/service struts in normal day-to-day operational environments.
		LG-16	No portion of the landing gear rigging process should require support equipment type templates, gauges, or tools. Indexes, reference points, etc., should be an integral part of the landing gear/airframe design.
		LG-17	Hydraulic, pneumatic, or electrical actuators associated with landing gear systems should not require adjustment or rigging once installed in the air vehicle. Spare units should be rigged at the time of manufacture or overhaul.
		LG-18	Landing gear ground safety down locks should be an integral part of the overall design. Use or reliance on loose pins (support equipment) should be avoided.
		LG-20	Special locks and pins used solely for landing gear ground maintenance safety should be used only in those cases substantiated by cost effectiveness analysis.
		LG-23	Design strut fittings for servicing nitrogen or hydraulic fluid to be easily accessible and adjacent to the appropriate strut pressure gage.
		LG-24	Design struts so they can be serviced with clean, dry air in lieu of nitrogen during deployments without affecting the overall reliability.
		LG-41	No more than 1 jack should be required to change any singular wheel/tire assembly.
		LG-42	Landing gear struts should contain built-in, dial type pressure gages.
		LG-43	Incorporate low pressure warning sensors in nose landing gear whenever under-servicing of the gear could result in failure to rotate aircraft during takeoff. This feature will eliminate many aborted take-offs, many of which result in blown tires or aircraft leaving the runway.
		MATL-01	A high degree of durability should be maintained for a minimum distance of 36 inches forward of the inflight refueling receptacle.
		MATL-02	Cosmetic type repairs should not exceed 1 hours including cure or drying times.
		MATL-03	Cosmetic and vehicle repair material shelf life should not be less than 24 months.
		MATL-04	Cosmetic and vehicle repair materials should be non-proprietary and non-single source.
		MATL-05	Cosmetic and vehicle repair materials should not require refrigeration or special facilities or atmospheres for storage.
		MATL-06	Repair criteria, repairs, and instructions should not be classified.
		MATL-07	All cosmetic touch-up and repair materials should be environmentally safe.
		MATL-08	Repairs (other than major depot repair) should not require autoclave type facilities.
		MATL-09	A high degree of durability should be achieved across all walkway areas on the top surfaces of all vehicles up to and including 95 percentile personnel.
		MATL-10	Coatings and finishes should be durable against the effects of missile gases, velocities, and particles emanating from the missile motor.
		MATL-11	Coatings and finishes should be durable against the effects of gun gases, projectile shock waves, and brass particles emanating from the projectile seal rings.
		MATL-13	Special handling or shipping requirements of repair materials should be avoided.

Guidelines by Category (Cont'd)

Category No.	Category Title	Guideline No.	Guideline
3.13.01	Support and Ground Handling Equipment	MATL-15	Doors and panels containing blade seals used for signature reduction should be interchangeable or contain interchangeable blade seals. Deviation is acceptable where repairs can be accomplished on the vehicle in a time equal to or less than door or seal remove and replace time.
		MC-01	All clamps should contain torque-set or torque-limiting connections to prevent clamp or component failure due to over-torque. Clamp installation call outs should not depend on special tools to establish the required torque values.
		MC-02	Avoid the use of cotter pins, safety wire, safety clips, and similar devices to prevent maintenance-induced events leading to ground vehicle accidents or loss of air vehicles.
		MC-03	All tubing connections and interfaces should use rosan/dynatube (or equivalent) to (1) enable connect or disconnect with one hand, one tool, (2) eliminate the need to safety the connection, (3) provide a superior seal, and (4) negate need to reposition line(s) during component replacement.
		MC-04	No trombone type, flared tube type, or piloted line type interfaces should be used to avoid the need for removal or repositioning during equipment removal.
		MC-05	Avoid potential foreign object traps during manufacturing or operational maintenance by eliminating vertical penetrations of plumbing/fittings into tanks, compartments, or cells
		MC-06	Locate, position, orient all plumbing and duct electrical connectors to prevent the need for sequential installation or removal.
		MC-09	All plumbing connections and fittings used for fuel systems should contain integral bonding features to eliminate the need for bonding clamps or jumper cables.
		MC-10	In rare instances where a plumbing run contains complex form or geometry that would require removal of other plumbing or equipment for access, in-line connectors should be incorporated to maintain the integrity of other plumbing or equipment.
		MC-11	No subsystem plumbing, equipment, or wiring should use a tank, cell, or compartment containing liquids as a means for routing or penetration simplicity during manufacture.
		MC-12	All plumbing and connectors containing liquids should be meniscus-free.
		MC-13	In instances where plumbing or connector interfaces cannot or are not keyed for a specific orientation, all identification, markings, cautions, and directions should be placed 360 degrees around the tube or duct.
		MC-14	Where multiple connectors are located in close proximity, ensure (1) a minimum hand tool arc of 120 degrees can be maintained, and (2) stagger fittings to ensure firm coupling interface/hand tool interface can be accomplished without inducing damage to adjacent lines.
		MC-15	Route, orient, and position plumbing, wiring, ducts, and connectors sufficiently away from the outer surface of the vehicle to preclude induced damage due to minor dents, drill bits during repair, etc. Minimum rule of thumb is 1" away from the inner surface and 1" below a plate nut channel.
		MG-01	Mount LRUs/sub-systems on drawer slides or extender racks to provide easier accessibility during integration, testing, debug, and repair of Units Under Test (UUTs).
		MG-02	Use a modular system design so that each subassembly is designed as a functionally complete entity. Then when a subassembly was removed for testing, ATE will not need custom circuitry to simulate missing functions.
		MG-03	Clearly mark all subsystems/LRUs to make system integration, test, debug, and repair easier.
		MP-01	Avoid the use epoxites to mount parts on repairable modules because they make repair extremely difficult.
		MP-02	Use a unique identification (ID) resistor incorporated in each system module to verify that the proper module is mounted on ATE.
		MP-03	Design modules so that lengthy warm-up times, special coding and air purity levels, and similar constraints are not necessary.
		OXY-01	System should contain automatic BIT for warning indicators to eliminate dedicated test switches and/or test requirements.
		P-01	Access door and panel fastener types for airborne vehicles should meet the following criteria: - use latches for a frequency of access of 0 to 40 flight hours - use High Strength Quick Release fasteners for a frequency of access of 40-400 flight hours - use structural screws for a frequency of access of 400 flight hours or more

Guidelines by Category (Cont'd)

Category No.	Category Title	Guideline No.	Guideline
3.13.01	Support and Ground Handling Equipment	P-02	Access door and panel fastener types for surface vehicles should meet the following criteria: - use a spring loaded or latch fastener for an opening frequency of daily - use a one quarter turn fastener (or equivalent) for a opening frequency of weekly - use screws or bolts for all other cases
		P-03	All doors and panels subject to environmental elements should contain form-in-place seals (or equivalent) attached to the door structure, not substructure, to prevent damage during maintenance.
		P-04	Door and panel seals should be compatible with all types of on-board servicing fluids, de-ice and anti-ice fluids, and all fluids used for chemical, biological, and nuclear decontamination.
		P-05	Piano type hinges should not be used on doors or panels because they are subject to wear, corrosion, and sand and fluid entry.
		P-06	Access door and panel devices used to support door in opened position should meet the following criteria: - for airborne vehicles, design for 60 knot gust loads (or equivalent jet blast loads) - for ground vehicles, design for 50 mph gust loads
		P-07	Hinged access doors and panels capable of remaining in the opened position should not have sharp edges or corners.
		P-08	Removable access door and panel fasteners should be of identical grip length and diameter.
		P-11	Access doors and panels should be interchangeable as justified by operation and support costs or life cycle costs.
		PYRO-11	Design electrical/electronic "safe/arm" systems to eliminate the need for mechanical type system interrupt devices.
		PYRO-13	Container design for shipping, handling, and storing weapons, flares, chaff, and similar devices should not require special atmospheres.
		PYRO-24	Ammo loader interface should not be less than 30" nor more than 50" above the ground to ensure loading can be accomplished by a wide range of percentiles wearing chemical or biological protective gear.
		PYRO-26	Do not locate ammunition loader interfaces close to inlets, exhausts, fuel dumps and drains, antennas, sensors, lights, or hazardous protrusions.
		PYRO-27	Incorporate integral hoisting provisions at each weapon/store station to enable direct lift from the container or carrier to the attachment hardpoints.
		PYRO-41	Weapon or store handling and transportation equipment should be compatible with rough terrain and capable of 25 mph towing speeds minimum.
		PYRO-42	In weapons carriage design and integration, avoid dependence of on-board high pressure nitrogen.
		PYRO-46	Design pylons, launchers, and ejector racks so that weapon loading, servicing, and reconfigurations can be accomplished using standard hand tools.
		PYRO-47	Installation design of ejectors, launchers, racks, and associated hardware interfaces should avoid reliance on torque wrenches.
		R-01	Large radomes wherein the combination of the diameter and length exceeds 60" should be top-hinged. Hinge should be load-carrying to reduce radome retention fastener count.
		R-02	Radome and radar array support structure design and material selection should eliminate the need for LO type fillers or shrouds.
		SABCH-02	All flush type structural screws should have identical head drives for the entire vehicle.
		SABCH-03	All non-flush type structural screws should have identical head drive recesses for the entire vehicle.
		SABCH-04	Special high strength bolts, such as twelve-point heads, should be fully justified from standpoint of the cost of ownership and effectiveness.
		SABCH-05	Structural design should avoid the reliance on blind fasteners unless fully supported by cost, weight, schedule, and effectiveness analysis.
		SABCH-11	In rare instances where the use of dissimilar material in immediate contact cannot be avoided, they should be sufficiently insulated to endure for the life of the vehicle.
		SABCH-12	Avoid tapping threads into structural members. Use of heli-coil type or similar insert concepts is permissible.

Guidelines by Category (Cont'd)

Category No.	Category Title	Guideline No.	Guideline
3.13.01	Support and Ground Handling Equipment	SABCH-13	No structural design concept should rely on frequent scheduled inspections to monitor or otherwise ensure structural integrity.
		SABCH-14	No structural fastener intended to carry shear or tension loads should be smaller than 1/4" diameter (.25").
		SABCH-15	Give preference to butt type splices over lap type splices in the design of manufacturing splices.
		SAFE-06	Wing fold locking mechanisms should provide a moldline indication that locks are in place. Loose or separate safety devices that must be installed manually should be avoided.
		SE-01	Wheel chocks for all types of ground and airborne vehicles should contain the following features: <ul style="list-style-type: none"> - Be nestable for low volume during storage or transport - Be manufactured from corrosion-resistant materials - Be releasable from tire pinch - Be highly visible for day and night operations - Be impervious to all types of fluids used to service or maintain the vehicles - Be of light weight
		SE-02	Wheel chocks for airborne vehicles should also contain the following features: <ul style="list-style-type: none"> - Contain provisions for securing to ramp or flight decks - Contain provisions to secure chocks at wheels - Releasable/removable from outside of hot brake envelope - Contain provisions to enable chock to be used as a tire blowout device - Contain provisions to prevent skidding on snow or ice
		SE-03	Wheel chock design guideline discussion. Wheel chocks have historically contributed to numerous accidents and incidents across the entire design spectrum, yet have received the least design attention of any ground handling/support equipment. Directly and indirectly, poorly designed chocks have: <ul style="list-style-type: none"> - Resulted in numerous "jumping the chocks" incidents due to improper use or positioning, and improper chock sizing for the tire size/power application. Some instances result in destruction of the aircraft. - Resulted in vehicle movement/sliding across wet, snowy and icy surfaces as a result of improper grip. - Resulted in unwarranted tire damage and/or engine FOD. - Resulted in tertiary damage to other vehicles or ground equipment as a result of being blown about by jet/propeller blast. - Damaged surfaces due to temporary placement of chocks on vehicle surfaces during vehicle movement. - Resulted in personnel sliver/s abrasions (wooden chocks) and cuts (metal chocks) even when chocks were in decent useable condition. - Resulted in varied personnel ground accidents during attempts to use chocks as a temporary work stand. - Lost aircraft "over the side" on carriers.
		SE-04	Gun port covers or plugs should be lightweight, 100% effective, and easy to install or store.
		SE-05	The geometric aspects of simple maintenance stands, ladders, and work platforms should enable high density stacking for storage and mobility deployments.
		SE-06	Non-metallic materials should take preference over metals to enable simple manufacturing and repair by bonding in lieu of weldments and/or mechanical fasteners.
		SE-07	The design construction concept and material selection for support equipment structure should not rely or depend upon the use of scheduled maintenance, NDI, or NDT to protect the durability or integrity of the equipment in the operational environment.
		SE-08	Support legs, posts, arms for ladders and workstands should contain integral non-skid devices for safe use on ice or snow.
		SE-09	Ladders and workstands used in close proximity to air and ground vehicles should contain effective buffers to protect finishes and treatments.
		SE-10	Protective finishes and coatings should meet the same ground environmental criteria as defined for air and ground vehicles.
		SE-11	Avoid reliance on mechanical fasteners solely to facilitate manufacturing.

Guidelines by Category (Cont'd)

Category No.	Category Title	Guideline No.	Guideline
3.13.01	Support and Ground Handling Equipment	SEAT-01	Design personnel seats and padding materials, including the covers and fillers, so they are incapable of creating or emitting toxic fumes or dense smoke when subjected to fire.
		SI-03	Parts and assemblies of a given model product or of models of a product in the same series should be interchangeable or replaceable.
		SIMP-01	Location and design of all exterior lights should not require protective covers in ground environments.
		SURV-02	Provide crew stations, crew compartments, and operator areas containing dinghies as emergency equipment with a suitable tool for puncturing or cutting the dinghy in the event of inadvertent inflation. Locate the tool so that access is assured during dinghy inflation.
		TCR-01	For each transmission, clutch, or rotor, provide a dedicated lubricating oil supply tank and system that is not shared with any other oil lubricating system.
		TCR-02	Provide each dedicated oil supply system with a separate servicing port/interface, pressure gauging, and quantity gauging system as applicable.
		TCR-03	Use a singular gage capable of reading pressures or quantities from two or more lubricating systems in preference to individual gages.
		TCR-04	Provide each dedicated system with an on-board spectrometric oil analysis program capability, separate oil filter, and separate oil, fuel, or air heat exchanger capability.
		TCR-05	Use the item's self-contained oil system to provide drive/interface spline lubrication, if required.
		TCR-06	In complex units, use different tracer elements in multiple gears, plates, discs, etc., so the source of wear can be easily identified by spectrometric oil analysis monitoring units.
		TCR-07	Design mechanical interfaces to transmissions, clutches, and rotors so that the respective unit can be replaced without the need for rigging.
		TCR-08	Incorporate vibration pick-up sensors to isolate the respective unit from other potential sources of vibration, and to enhance the prognostic potential for monitoring equipment health.
		TP-01	Locate Input/Output (I/O) test points and associated readouts in close proximity to each other so that one person can perform testing.
		TP-02	Protect test points against the environment and from induced contamination.
		TP-03	Protect test points from outside signal generation.
		W-01	Hat section type structural stiffeners with sufficient cross sectional area should be considered as a routing tunnel for wiring and coax.
3.13.02	Cleaning and Decontamination	WBAY-05	Gap treatment should not interfere with or be damaged by existing pylon handling support equipment.
		WBAY-17	Special coatings or conductive paints on pylons, launchers, racks, launchers, tanks, pods, etc. should have the durability to withstand contact with support stands/cradles during storage.
		WIND-02	Optic windows should be located for ease of inspection, cleaning, and induced damage potential from personnel or support equipment.
		A-01	Seal equipment bays and compartments against the environmental elements including all types of servicing fluids used for the vehicle, all types of anti-ice and de-ice fluids, and all types of fluids used for chemical, biological, or nuclear decontamination
		A-07	Paint equipment bay and compartment interiors a high gloss white to maximize lighting reflectivity, visibility, and rapid leak detection capability.
		A-10	Provide a sufficient number of compartment fluid drains to ensure fluid drainage for varying aircraft static attitudes and varying terrain slopes for ground vehicles.
		A-11	Locate compartment electrical penetrations close to the access opening for ease of sight, probing, repair, and to eliminate fluid soaking, wicking, or contamination.
		A-12	Locate compartment electrical penetrations far enough from the access opening to prevent damage resulting from improper (over-length) panel fasteners.
		A-16	Structural design should provide good access to corrosion-prone areas for inspection and treatment.

Guidelines by Category (Cont'd)

Category No.	Category Title	Guideline No.	Guideline
3.13.02	Cleaning and Decontamination		
		CBR-01	Orient all vehicle liquid servicing fittings to ensure fluids will not come in contact with protective garb during connect/disconnect activities.
		CBR-02	Ensure vehicle overboard passive liquid drains are clearly marked or visible to enable personnel to remain clear of area.
		CC-06	Label, and where possible color code, each wire in a harness or cable to facilitate tracking from origin to termination. Each wire, cable, and coax-to-connector interface should be provided with a source of identification to aid in trouble shooting, repair, or modification. Marking the cable designer on the cable along with bar codes is also recommended.
		CC-07	Do not manufacture or dress connectors containing more than 25 wires or cables as a single integrated harness. Group the wires or cables into runs of no more than 25 wires or cables each. In addition to making trouble shooting and repair easier, this approach help avoid large bend radii, thereby simplifying routing, packaging, and stowage.
		CC-08	Standardize connector pin assignments for power, ground, and other frequently used signals.
		CC-09	Locate LRU/subsystem critical nodes (and or test points) so they are accessible from a connector to prevent the need for internal LRU probing or access.
		CC-10	Avoid hidden cables. Visually inspecting and tracing all assembly cables rather than having hidden cables (such as behind other cables or even LRUs) allows for a quick system and cable integrity check which aids in overall system integrity and debug. This also implies quick access for manipulative actions.
		CREW-08	Data storage media containers and modules should be capable of chemical and biological decontamination processes.
		D&V-01	The geometric aspects of structural design and interfaces should not result in any natural bathtubs.
		D&V-02	Closed structural sections subject to condensation or fluid migration should contain drainage provisions.
		D&V-03	Crew cabs, operators' compartments, crew stations, cockpits, and passenger compartments should be subject to the same corrosion prevention measures as the exteriors of the vehicles. Low points, pockets, and related fluid collection points within should be provided with low point drains.
		EDECOM-01	Provide surface sensors on equipment located in compartments containing louvers, screens, flush inlets, or similar openings to the environment to indicate the presence of chem/bio contaminants.
		EDECOM-02	Provide integral sensors (viewable from the exterior) for equipment subject to internal forced-air cooling from outside or external air to indicate the presence of contaminants.
		EDECOM-03	Design equipment surfaces and structure to be compatible with all decontamination agents and methods.
		EDECOM-04	Provide passive overboard drains in compartments subject to decontamination processes to void the area of contaminants.
		EDECOM-05	Provide hoist, lift or transport handles for equipment requiring removal from the host vehicle for decontamination. In instances where this may not be practical, design the equipment with handpoints for attaching parasitic carrying provisions
		EG-11	To improve the probability of fault detection, avoid shorting signals together to achieve a specific test function or condition.
		EG-12	Incorporate concept for partitioning module functions to simplify test equipment or eliminate the need for ancillary test equipment.
		EG-13	Design oscillators or clocks that are resident on the module to be replaceable by a signal from a connector to avoid the need to synchronize ATE to on-board signals.
		ENG(G)-16	Do not locate batteries in the engine compartment. In those instances where this is not possible: - The battery support structure should be of a material that is impervious to acid leakage or boil-over. - The battery support structure should serve as a scupper to collect and direct the acid out of the engine compartment.
		ENG(G)-19	Paint engine compartments gloss white to enhance light reflectivity and enhance fluid leak detection.
		ENG-06	All other engine surfaces and engine-mounted accessory surfaces should be free of pockets, channels, and bathtubs that could trap and retain fluids.
		ENG-10	On multi-engine air vehicles, the airframe-to-engine interfaces should be in identical positions or orientations for each engine cavity.
		ENG-37	Gravity type servicing fittings, covers, and caps should have integral locking features, openable by hand, and contain a cable or chain to prevent loss or dropping.
		ENG-46	Design the basic engine and engine-mounted accessory interface so that no fluid traps or bathtubs exist regardless of engine-mounted accessory location.

MIL-HDBK-470A

APPENDIX C

Guidelines by Category (Cont'd)

Category No.	Category Title	Guideline No.	Guideline
3.13.02	Cleaning and Decontamination	ENG-47	Design the engine, including all accessories, plumbing, wiring, ducts, and mechanisms, to meet the same environmental protection and compatibility requirements as the host vehicle.
		ENV-01	Materials, treatments, coatings, finishes should be compatible with all anti-ice and de-ice fluids, chemical and biological decontamination fluids, washing and cleaning fluids, and all vehicle subsystem fluids.
		ENV-02	There should be no top coat or treatment deterioration throughout the standard temperature and humidity spectrum.
		ENV-03	For airborne vehicles, the finishes should be durable against rain, hail, and dynamic erosion throughout the flight envelope.
		ENV-04	For airborne and ground vehicles, the finishes should be durable against sand erosion throughout all surface wind speeds experienced in arid or desert geographical locations.
		ENV-05	For airborne vehicles, materials and all finishes with the engine inlet should be durable against hammer shock and compressor stalls.
		EXH-01	Treatments required for engine hot sections and exhaust areas should not require scheduled removals for the purposes of recoating.
		EXH-02	High temperature exhaust patterns should flow away from or be directed away from treated surrounding structure, coatings, or finishes.
		FI-06	In an airborne avionics system, consider indicating mission critical faults on a pilots "head-up" display accompanied with an audible alarm, so that the pilot can easily check for critical system or mission threatening problems.
		FI-07	Ensure that system user manuals include instructions for faults not covered by BIT such as, system will not power up or system is being used in an incorrect environment such as, at the wrong altitude, etc.
		FI-08	Interlock the high power sections of systems and subsystems with visual/audible BIT to ensure safe system activation.
		FI-09	Design BIT to first conduct self-test for circuitry integrity before conducting system test.
		FI-10	Use clear text to report failures rather than alpha-numeric codes, lights, indicators, etc.
		FI-11	Locate BIT circuitry on the same level of the subsystem under test to simplify test and repair when it is removed from the main system.
		IN(V)-08	Incorporate an inlet closure door sealing concept that prevents entry of fluid, dust, or sand across the entire airborne and ground environment spectrum.
		LG-01	Bearings, excluding wheel bearings, should not require lubrication during the expected life of the air vehicle airframe.
		LO-01	Use LO compatible gap fillers for manufactured gaps in lieu of tape and butter (surface coating compound).
		LO-02	Avoid scheduled forced inspections or replacement of materials, coatings, or finishes solely to protect either the reliability or the signature.
		MATL-01	A high degree of durability should be maintained for a minimum distance of 36 inches forward of the inflight refueling receptacle.
		MATL-02	Cosmetic type repairs should not exceed 1 hour including cure or drying times.
		MATL-03	Cosmetic and vehicle repair material shelf life should not be less than 24 months.
		MATL-04	Cosmetic and vehicle repair materials should be non-proprietary and non-single source.
		MATL-05	Cosmetic and vehicle repair materials should not require refrigeration or special facilities or atmospheres for storage.
		MATL-06	Repair criteria, repairs, and instructions should not be classified.
		MATL-07	All cosmetic touch-up and repair materials should be environmentally safe.
		MATL-08	Repairs (other than major depot repair) should not require autoclave type facilities.
		MATL-09	A high degree of durability should be achieved across all walkway areas on the top surfaces of all vehicles up to and including 95 percentile personnel.
		MATL-10	Coatings and finishes should be durable against the effects of missile gases, velocities, and particles emanating from the missile motor.
		MATL-11	Coatings and finishes should be durable against the effects of gun gases, projectile shock waves, and brass particles emanating from the projectile seal rings.
		MATL-12	Leading edge materials and coatings should be durable against fragments from frangible gun port plugs.

Guidelines by Category (Cont'd)

Category No.	Category Title	Guideline No.	Guideline
3.13.02	Cleaning and Decontamination		
		MATL-14	Leading edges, including chimes, containing or constructed of radar absorbing materials, should be interchangeable to reduce vehicle downtime and simplify repairs.
		MATL-15	Doors and panels containing blade seals used for signature reduction should be interchangeable or contain interchangeable blade seals. Deviation is acceptable where repairs can be accomplished on the vehicle in a time equal to or less than door or seal remove and replace time.
		MC-01	All clamps should contain torque-set or torque-limiting connections to prevent clamp or component failure due to over-torque. Clamp installation call outs should not depend on special tools to establish the required torque values.
		MC-02	Avoid the use of cotter pins, safety wire, safety clips, and similar devices to prevent maintenance-induced events leading to ground vehicle accidents or loss of air vehicles.
		MC-03	All tubing connections and interfaces should use rosan/dynatube (or equivalent) to (1) enable connect or disconnect with one hand, one tool, (2) eliminate the need to safety the connection, (3) provide a superior seal, and (4) negate need to reposition line(s) during component replacement.
		MC-04	No trombone type, flared tube type, or piloted line type interfaces should be used to avoid the need for removal or repositioning during equipment removal.
		MC-05	Avoid potential foreign object traps during manufacturing or operational maintenance by eliminating vertical penetrations of plumbing/fittings into tanks, compartments, or cells
		MC-06	Locate, position, orient all plumbing and duct electrical connectors to prevent the need for sequential installation or removal.
		MC-07	Maximize areas of constant web thickness in firewalls, carry-through bulkheads, major frames, structural ribs, spars, webs, keels, and close-outs to provide flexibility in locating penetration fittings. Stepped chem milling, stepped machining, stepped composite layup concepts all tend to result in minimal available surface area for penetrations.
		MC-08	All in-line plumbing connections within a fuel tank or cell should be capable of making/breaking the interface by hand, require no torque, contain integral safety locking mechanisms, and should be void of any requirement for safety wire.
		MC-09	All plumbing connections and fittings used for fuel systems should contain integral bonding features to eliminate the need for bonding clamps or jumper cables.
		MC-12	All plumbing and connectors containing liquids should be meniscus-free.
		MC-13	In instances where plumbing or connector interfaces cannot or are not keyed for a specific orientation, all identification, markings, cautions, and directions should be placed 360 degrees around the tube or duct.
		MC-14	Where multiple connectors are located in close proximity, ensure (1) a minimum hand tool arc of 120 degrees can be maintained, and (2) stagger fittings to ensure firm coupling interface/hand tool interface can be accomplished without inducing damage to adjacent lines.
		P-03	All doors and panels subject to environmental elements should contain form-in-place seals (or equivalent) attached to the door structure, not substructure, to prevent damage during maintenance.
		P-04	Door and panel seals should be compatible with all types of on-board servicing fluids, de-ice and anti-ice fluids, and all fluids used for chemical, biological, and nuclear decontamination.
		P-05	Piano type hinges should not be used on doors or panels because they are subject to wear, corrosion, and sand and fluid entry.
		PYRO-34	Weapon bay door seals should be bonded or attached to door structure to minimize induced seal damage during weapon or store loading.
		SABCH-06	Structural design should avoid the potential of dissimilar material or fastener corrosion.
		SEAT-02	Design personnel seats and padding materials so they are incapable of absorbing and holding fluids.
		WBAY-08	Gap seal and treatment should be fully compatible with steam from carrier catapults.
		WBAY-09	Gap seal/pylon should not cover or hamper access to low point wing drains.
		WBAY-16	Gap seals should not degrade loading while wearing arctic or chemical, biological, or radiation protective clothing.
		WBAY-17	Special coatings or conductive paints on pylons, launchers, racks, launchers, tanks, pods, etc. should have the durability to withstand contact with support stands/cradles during storage.

Guidelines by Category (Cont'd)

Category No.	Category Title	Guideline No.	Guideline
3.13.02	Cleaning and Decontamination	WBAY-18	The proximity of the gun firing barrel to structure should be such that structural furrows or channels are not required for projectile clearances during firing.
		WBAY-21	Coatings and finishes in the area of gun barrels should be durable to withstand the effect of exiting projectile shockwaves.
		WBAY-22	The proximity of the gun blast deflector to structure should not require reliance on high-temperature paints or coatings to protect the structure.
		WIND-01	Optical window materials should be scratch resistant, easy to clean, and dissipate electrostatic charges.
		WIND-02	Optic windows should be located for ease of inspection, cleaning, and induced damage potential from personnel or support equipment.
		WIND-03	Window locations should minimize the effects of contamination by salt spray, bugs, oils, fuels, and icing.
		WIND-04	Window, canopy, and windshield material should be designed to withstand the effects of sandstorms in the ground environment and the effects of rain and hail during thunderstorm penetration in the airborne environment.
		WIND-05	Design interior surfaces to be reachable for cleaning without reliance on hinging, equipment removal, or use of support equipment.
		WIND-06	Do not locate windows in the proximity of rooster tails created by wheels/tires passing through water or slush.
		WIND-11	For dome-shaped optic window concepts, the dome should be easily removable for cleaning without affecting LO integrity.
		WT&B-17	Electrical connector environmental protection should be capable of withstanding water pressure streams up to 120 psi encountered during decontamination, wash, etc.
3.14	Test and Diagnostics	A-11	Locate compartment electrical penetrations close to the access opening for ease of sight, probing, repair, and to eliminate fluid soaking, wicking, or contamination.
		A-12	Locate compartment electrical penetrations far enough from the access opening to prevent damage resulting from improper (over-length) panel fasteners.
		A-18	Use transparent windows, quick-opening covers, or openings without any cover to permit quick visual inspections where needed.
		ACS-10	Ensure all diagnostic and prognostic logic, intelligence, and status type informational data are storable and viewable within the crew station.
		ACS-11	Provide crew station personnel with the capability to manually initiate selective BIT and interrogate the prognostics system without interrupting the full-time or periodic BIT routines.
		BIT-01	During design of the BIT, use worst-case stress analysis to ensure that any circuit failures induced by temperature extremes, tolerance build-up, power supply variations, and combinations thereof are identified.
		BIT-02	Ensure that BIT system thresholds are consistent with those across the system, subsystem, item, module, and piece-part levels to prevent excessive numbers of Cannot Duplicate (CND) and Retest OK (RTOK) events from occurring.
		BIT-03	The degree of BIT required or proposed should be based on the respective failure rates and the appropriate FMECA at all equipment indented levels.
		BIT-04	Limit the amount of data that is recorded to a manageable size by: <ul style="list-style-type: none"> - Limiting the number of signals that are monitored - Limiting the maximum sampling rate - Reducing the time span over which data is accumulated - Restricting the type of data accumulated
		BIT-05	Incorporate testability design features as an integral part of equipment preliminary design process.
		BIT-06	Mission critical functions should be monitored by BIT.
		BIT-07	Set BIT tolerances to maximize fault detection and minimize false alarm rate in the expected operating environment.
		BIT-08	Design BIT fault detectors to accommodate the needs of operator maintenance personnel.
		BIT-09	Use concurrent BIT to monitor system critical functions.
		BIT-10	Design the BIT and BITE so that no fault or failure within the BIT or BITE will degrade, disrupt, or fail the system being monitored.

Guidelines by Category (Cont'd)

Category No.	Category Title	Guideline No.	Guideline
3.14	Test and Diagnostics	BIT-11	In the area of software design and test responsibility, the responsibility for the design and development of verification testing of an end item (e.g., digital filter) should reside with the same engineer(s).
		BIT-12	Define stimuli and response data for each diagnostic test at the system/subsystem level. The same data should be planned for use both in factory testing as well as in field maintenance of the equipment. These data minimize the amount of unique software to be written.
		BIT-13	Provide for manual control to test sequences, so that the test can be selected individually, and appropriate test combinations can be executed at the operator's discretion.
		BIT-14	Provide access to all BIT control and status signals at module connector pins. This will enable ATE to directly connect to BIT circuitry.
		BIT-15	Incorporate complete BIT functions and BITE on module. If only a portion of the BIT routine or BITE circuitry exists on the module, then ATE cannot utilize the BIT routine without providing the missing BIT functions.
		BIT-16	Critical voltages should be visually monitored by sending the voltage signals to visible LEDs.
		BIT-17	BIT failures should be latched on the module. This makes it easier for the system or ATE to poll the error bit at any time.
		BIT-18	If many BIT routines exist on a module, then ATE should have access and the ability to control each routine individually.
		BIT-19	Design BIT to have a very low false alarm rate; otherwise BIT will not be an effective maintenance tool. As a goal, the false alarm rate should be 1% or less.
		BIT-20	The BIT should be mechanized so that when a piece of equipment is not installed in a subsystem or the product, a failure will not be indicated.
		BIT-21	The failure detection function should provide the equipment operator with a go/no-go indication of equipment readiness.
		BIT-22	The BIT should be designed so that auxiliary test devices or external equipment are not needed for daily and other regular checks.
		BIT-23	Design BIT so it is initiated automatically upon equipment power-up.
		BIT-24	Test points should be functionally grouped together and clearly labeled for convenience and ease of maintenance.
		BIT-25	Equipment should not require manual probing to fault isolate.
		BIT-26	Locate routinely used test points so they are accessible without removing or disassembling other equipment
		BIT-27	Periodic and initiated BIT should detect at least 98% of all failures and isolate a minimum 99% of those failures detected to a single LRU or WRA.
		BIT-28	Design BIT to have the same level of EMI protection as the system or equipment being monitored.
		BIT/BITE-01	Design to keep false alarm rates below 1%. Higher false alarm rates can limit the effectiveness of BIT as a maintenance tool.
		BIT/BITE-02	Design EMI protection to eliminate finger type EMI contact devices.
		CC-01	Use fiber-optic technologies in preference to conventional interconnect concepts to reduce the number of interconnects/interfaces, reduce manufacturing and ownership costs, and significantly improve R&M.
		CC-02	Standardize connector and wire types to improve testability and logistic support. Keep the number of "different" standard connectors to a minimum. Use the same connector type keyed differently where possible.
		CC-03	Provide clearance around connectors for engagement/disengagement of cables and proper connector orientation under anticipated environmental conditions (e.g., bare hand of 50 percentile male in an enclosed or protected environment and a gloved hand of a 50 percentile male in an open or unprotected environment).
		CC-04	Use quick release cables and locate cables to make removal and replacement easy and to avoid having to remove one cable to gain access to another. Provide adequate space for cables, including sleeving and tie-downs, and adequate service loops for ease of assembly/disassembly
		CC-05	Orient and space connectors to allow a sufficient grip on the connector for cable or wire extraction without fear of using the wiring or cable for additional leverage.
		CC-06	Label, and where possible color code, each wire in a harness or cable to facilitate tracking from origin to termination. Each wire, cable, and coax-to-connector interface should be provided with a source of identification to aid in trouble shooting, repair, or modification. Marking the cable designator on the cable along with bar codes is also recommended.

Guidelines by Category (Cont'd)

Category No.	Category Title	Guideline No.	Guideline
3.14	Test and Diagnostics	CC-07	Do not manufacture or dress connectors containing more than 25 wires or cables as a single integrated harness. Group the wires or cables into runs of no more than 25 wires or cables each. In addition to making trouble shooting and repair easier, this approach help avoid large bend radii, thereby simplifying routing, packaging, and stowage.
		CC-08	Standardize connector pin assignments for power, ground, and other frequently used signals.
		CC-09	Locate LRU/subsystem critical nodes (and or test points) so they are accessible from a connector to prevent the need for internal LRU probing or access.
		CC-10	Avoid hidden cables. Visually inspecting and tracing all assembly cables rather than having hidden cables (such as behind other cables or even LRUs) allows for a quick system and cable integrity check which aids in overall system integrity and debug. This also implies quick access for manipulative actions.
		CC-11	Orient spare wires and cable pigtailed along the outer diameter or periphery of connectors to make access easier.
		CC-12	Build up and assemble straight and angle connector shells or back shells in a manner that ensures that wire or cable strain or wear is not possible.
		CO-01	Design automated systems and programs with provisions to enable "stop test" and "resume" without the need to cycle back or repeat the entire test.
		CO-02	In the event of program loss or hang-up, automated systems and programs should have provisions for reverting to manual test and operation.
		CO-03	Use a test connector to provide test and maintenance bus access to all system and subsystem faults.
		CO-04	Design systems and subsystems so that ATE can be used to access, read, and control internal components in concert with the test or checkout program.
		CO-05	Avoid the need for costly adapters for signal communications between system, subsystems, line replaceable units (LRUs) or Weapon Replaceable Assemblies (WRAs), and ATE.
		EC-15	The removal or replacement of electronic equipment should not require the removal of any other piece of equipment or armament.
		EC-21	Locate connectors far enough apart so that they meet specified requirements.
		EC-22	All connectors should be keyed differently with aligning pins that extend beyond the electrical pins. Connector pins and sockets should engage after key position is entered.
		EC-23	Design connectors so that plugs are cold and receptacles are hot.
		EC-24	Use electrical connectors that incorporate alignment key-ways to reduce incidents of damage due to improper engagement.
		EC-25	Use positive locking, quick disconnect electrical connectors to save man-hours, prevent foreign object damage (FOD) and decrease the chance of personal injury.
		EC-26	Avoid using identical electrical connectors in adjacent areas.
		EG-01	Design feedback loops so that the loop can be broken during test to ensure that faults do not propagate to the point where they cannot be isolated.
		EG-02	Avoid using external feedback loops requiring complex circuitry to simulate feedback I/Os.
		EG-03	In rare instances when complex external feedback loops cannot be avoided, incorporate simple interruptible control points.
		EG-04	Avoid long sequences of vectors to initialize or alter device outputs to minimize potential testability problems.
		EG-05	Avoid the need to have test equipment generate complex, phased or time related signals.
		EG-06	Test points should be located on all circuit nodes that are useful in determining the module's health.
		EG-07	Test points should be designed so that functional circuitry cannot be damaged or degraded due to the routing or accidental shorting of a signal at a test point. Some type of test point isolation technique should be used (buffers, isolator, etc.).
		EG-08	Test points should be easily accessed and clearly marked.
		EG-10	Design redundant circuits to be independently testable to ensure errors are not masked.
		EG-11	To improve the probability of fault detection, avoid shorting signals together to achieve a specific test function or condition.

Guidelines by Category (Cont'd)

Category No.	Category Title	Guideline No.	Guideline
3.14	Test and Diagnostics		
		EG-12	Incorporate concept for partitioning module functions to simplify test equipment or eliminate the need for ancillary test equipment.
		EG-13	Design oscillators or clocks that are resident on the module to be replaceable by a signal from a connector to avoid the need to synchronize ATE to on-board signals.
		ENG(G)-18	Incorporate appropriate sensors to enhance the diagnostic and prognostic capabilities for the following: <ul style="list-style-type: none"> - Oil temperature - Fuel filter bypass - Oil pressure - Coolant pressure - Oil filter bypass - Coolant level - Oil cooler bypass valve position - Coolant temperature - Oil level - Vibration pickups - Oil return line particle count - Chip detector
		ENG-01	All facets of engine design should take advantage of Electrostatic Engine Monitoring Systems (EEMS) and Inductive Debris Monitoring (IDM) toward achievement of on-condition maintenance and engine health monitoring.
		ENG-02	Each different component of rotating machinery should contain different tracer elements to enhance EEMS and IDM isolation and tracking of wear.
		ENG-03	Digital electronic controls, fully automatic digital electronic controls, and similar concepts should contain the highest degree of BIT and diagnostics commensurate with affordability, operation and maintenance, and life cycle costs as appropriate.
		ENG-13	Engine oil systems should contain on-board spectrometric oil analysis devices located on the engine.
		ENG-23	All engine borescope provisions should be accessible with the engine installed and hooked up.
		ENG-26	Locate and position engine overheat and fire warning sensors so that damage cannot occur during engine maintenance or replacement.
		ENG-27	No rigging or calibration should be required following engine replacement.
		ENG-28	No engine operational start and checkout should be required following engine replacement.
		ENG-38	The characteristics of engine-to-vehicle interfaces coupled with the capabilities of electronic engine controls, should negate the necessity for making any type of engine rigging including maximum power, idle, and idle cut-off.
		ENG-52	Incorporate provisions to enable very slow rotation of the fan, compressor, and turbine during borescope inspections.
		ENG-53	Design magnetic chip detectors to ensure that oil shut-off will occur as the detector is being removed for visual inspection.
		ENG-54	Incorporate provisions for fuzz burn-off in magnetic chip detectors.
		FI-01	Design each FI test to be independent of all other tests.
		FI-02	Design FI initiation to be subordinate to the higher priority predecessor tests.
		FI-03	Design each test so that it can be terminated prior to completion and then re-initiated at its start point.
		FI-04	Design the unit tests so that they can accommodate the following subsystem response modes: <ul style="list-style-type: none"> - Incorrect response - No response - Inconsistent response - Unexpected condition
		FI-05	Design all software so that it is structured by test priority. The test software should take advantage of both subroutine constructs for all message outputs and of failure dictionaries which identify the location of the most likely failed replaceable unit.
		FI-06	In an airborne avionics system, consider indicating mission critical faults on a pilots "head-up" display accompanied with an audible alarm, so that the pilot can easily check for critical system or mission threatening problems.
		FI-07	Ensure that system user manuals include instructions for faults not covered by BIT such as, system will not power up or system is being used in an incorrect environment such as, at the wrong altitude, etc.
		FI-08	Interlock the high power sections of systems and subsystems with visual/audible BIT to ensure safe system activation.
		FI-09	Design BIT to first conduct self-test for circuitry integrity before conducting system test.

Guidelines by Category (Cont'd)

Category No.	Category Title	Guideline No.	Guideline
3.14	Test and Diagnostics	FI-10	Use clear text to report failures rather than alpha-numeric codes, lights, indicators, etc.
		FI-11	Locate BIT circuitry on the same level of the subsystem under test to simplify test and repair when it is removed from the main system.
		MC-12	All plumbing and connectors containing liquids should be meniscus-free.
		MG-01	Mount LRUs/sub-systems on drawer slides or extender racks to provide easier accessibility during integration, testing, debug, and repair of Units Under Test (UUTs).
		MG-02	Use a modular system design so that each subassembly is designed as a functionally complete entity. Then when a subassembly was removed for testing, ATE will not need custom circuitry to simulate missing functions.
		MG-03	Clearly mark all subsystems/LRUs to make system integration, test, debug, and repair easier.
		MP-01	Avoid the use of epoxies to mount parts on repairable modules because they make repair extremely difficult.
		MP-02	Use a unique identification (ID) resistor incorporated in each system module to verify that the proper module is mounted on ATE.
		MP-03	Design modules so that lengthy warm-up times, special coding and air purity levels, and similar constraints are not necessary.
		TP-01	Locate Input/Output (I/O) test points and associated readouts in close proximity to each other so that one person can perform testing.
		TP-02	Protect test points against the environment and from induced contamination.
		TP-03	Protect test points from outside signal generation.
		A-16	Structural design should provide good access to corrosion-prone areas for inspection and treatment.
		BIT-06	Mission critical functions should be monitored by BIT.
		BIT-26	Locate routinely used test points so they are accessible without removing or disassembling other equipment
		BIT-27	Periodic and initiated BIT should detect at least 98% of all failures and isolate a minimum 99% of those failures detected to a single LRU or WRA.
		BIT-28	Design BIT to have the same level of EMI protection as the system or equipment being monitored.
		BIT/BITE-01	Design to keep false alarm rates below 1%. Higher false alarm rates can limit the effectiveness of BIT as a maintenance tool.
		BIT/BITE-02	Design EMI protection to eliminate finger type EMI contact devices.
		CC-07	Do not manufacture or dress connectors containing more than 25 wires or cables as a single integrated harness. Group the wires or cables into runs of no more than 25 wires or cables each. In addition to making trouble shooting and repair easier, this approach help avoid large bend radii, thereby simplifying routing, packaging, and stowage.
		CC-08	Standardize connector pin assignments for power, ground, and other frequently used signals.
		CC-09	Locate LRU/subsystem critical nodes (and or test points) so they are accessible from a connector to prevent the need for internal LRU probing or access.
		CC-10	Avoid hidden cables. Visually inspecting and tracing all assembly cables rather than having hidden cables (such as behind other cables or even LRUs) allows for a quick system and cable integrity check which aids in overall system integrity and debug. This also implies quick access for manipulative actions.
		EG-01	Design feedback loops so that the loop can be broken during test to ensure that faults do not propagate to the point where they cannot be isolated.
		EG-02	Avoid using external feedback loops requiring complex circuitry to simulate feedback I/Os.
		EG-03	In rare instances when complex external feedback loops cannot be avoided, incorporate simple interruptible control points.
		EG-04	Avoid long sequences of vectors to initialize or alter device outputs to minimize potential testability problems.
		EG-05	Avoid the need to have test equipment generate complex, phased or time related signals.
		EG-06	Test points should be located on all circuit nodes that are useful in determining the module's health.
		EG-07	Test points should be designed so that functional circuitry cannot be damaged or degraded due to the routing or accidental shorting of a signal at a test point. Some type of test point isolation technique should be used (buffers, isolator, etc.).

Guidelines by Category (Cont'd)

Category No.	Category Title	Guideline No.	Guideline
3.14.01	Non-destructive Test and Inspection		
		EG-08	Test points should be easily accessed and clearly marked.
		EG-10	Design redundant circuits to be independently testable to ensure errors are not masked.
		EG-11	To improve the probability of fault detection, avoid shorting signals together to achieve a specific test function or condition.
		EG-12	Incorporate concept for partitioning module functions to simplify test equipment or eliminate the need for ancillary test equipment.
		EG-13	Design oscillators or clocks that are resident on the module to be replaceable by a signal from a connector to avoid the need to synchronize ATE to on-board signals.
		ENG-01	All facets of engine design should take advantage of Electrostatic Engine Monitoring Systems (EEMS) and Inductive Debris Monitoring (IDM) toward achievement of on-condition maintenance and engine health monitoring.
		ENG-02	Each different component of rotating machinery should contain different tracer elements to enhance EEMS and IDM isolation and tracking of wear.
		ENG-03	Digital electronic controls, fully automatic digital electronic controls, and similar concepts should contain the highest degree of BIT and diagnostics commensurate with affordability, operation and maintenance, and life cycle costs as appropriate.
		ENG-23	All engine borescope provisions should be accessible with the engine installed and hooked up.
		ENG-52	Incorporate provisions to enable very slow rotation of the fan, compressor, and turbine during borescope inspections.
		FI-01	Design each FI test to be independent of all other tests.
		FI-02	Design FI initiation to be subordinate to the higher priority predecessor tests.
		FI-03	Design each test so that it can be terminated prior to completion and then re-initiated at its start point.
		FI-04	Design the unit tests so that they can accommodate the following subsystem response modes: <ul style="list-style-type: none"> - Incorrect response - No response - Inconsistent response - Unexpected condition
		FI-05	Design all software so that it is structured by test priority. The test software should take advantage of both subroutine constructs for all message outputs and of failure dictionaries which identify the location of the most likely failed replaceable unit.
		FI-06	In an airborne avionics system, consider indicating mission critical faults on a pilots "head-up" display accompanied with an audible alarm, so that the pilot can easily check for critical system or mission threatening problems.
		FI-07	Ensure that system user manuals include instructions for faults not covered by BIT such as, system will not power up or system is being used in an incorrect environment such as, at the wrong altitude, etc.
		FI-08	Interlock the high power sections of systems and subsystems with visual/audible BIT to ensure safe system activation.
		FI-09	Design BIT to first conduct self-test for circuitry integrity before conducting system test.
		FI-10	Use clear text to report failures rather than alpha-numeric codes, lights, indicators, etc.
		FI-11	Locate BIT circuitry on the same level of the subsystem under test to simplify test and repair when it is removed from the main system.
		HOOK-03	NGT/NGH mechanisms should not require scheduled visual or NDI type inspections.
		MC-02	Avoid the use of cotter pins, safety wire, safety clips, and similar devices to prevent maintenance-induced events leading to ground vehicle accidents or loss of air vehicles.
		NDI-01	Avoid reliance of extensive interpretation by NDI equipment operators to detect structural flaws.
		NDI-02	Do not use non-destructive inspection technologies to maintain or protect the reliability of an item.
		NDI-03	Derive NDI/NDT requirements from the Failure Mode Effects and Criticality Analysis (FMECA) and the associated Reliability Centered Maintenance (RCM) analysis and documentation.

Guidelines by Category (Cont'd)

Category No.	Category Title	Guideline No.	Guideline
3.14.01	Non-destructive Test and Inspection	NDI-04	Evaluate selective application of appropriate NDI/NDT technologies against high-time units, items, and vehicles with the intent of: <ul style="list-style-type: none"> - Finding the optimum time intervals, - Preventing the across-the-board application of NDI/NDT, - Increasing the time intervals between inspections, and - Eliminating the requirement.
		NDI-05	Include the effect and impact of NDI/NDT applications as a major element in developing operations and support cost (O&S) analysis to include: <ul style="list-style-type: none"> - Cost of Equipment - Cost of Facilities - Cost of PMEL - Cost of training/retraining - Cost of personnel - Impact on deployment - Impact on sea/air/land lift
		SE-07	The design construction concept and material selection for support equipment structure should not rely or depend upon the use of scheduled maintenance, NDI, or NDT to protect the durability or integrity of the equipment in the operational environment. <p>Locate compartment electrical penetrations close to the access opening for ease of sight, probing, repair, and to eliminate fluid soaking, wicking, or contamination.</p> <p>Locate compartment electrical penetrations far enough from the access opening to prevent damage resulting from improper (over-length) panel fasteners.</p> <p>During design of the BIT, use worst-case stress analysis to ensure that any circuit failures induced by temperature extremes, tolerance build-up, power supply variations, and combinations thereof are identified.</p> <p>Ensure that BIT system thresholds are consistent with those across the system, subsystem, item, module, and piece-part levels to prevent excessive numbers of Cannot Duplicate (CND) and Retest OK (RTOK) events from occurring.</p> <p>The degree of BIT required or proposed should be based on the respective failure rates and the appropriate FMECA at all equipment indeture levels.</p> <p>Limit the amount of data that is recorded to a manageable size by: <ul style="list-style-type: none"> - Limiting the number of signals that are monitored - Limiting the maximum sampling rate - Reducing the time span over which data is accumulated - Restricting the type of data accumulated </p> <p>Incorporate testability design features as an integral part of equipment preliminary design process.</p> <p>Mission critical functions should be monitored by BIT.</p> <p>Set BIT tolerances to maximize fault detection and minimize false alarm rate in the expected operating environment.</p> <p>Design BIT fault detectors to accommodate the needs of operator maintenance personnel.</p> <p>Use concurrent BIT to monitor system critical functions.</p> <p>Design the BIT and BITE so that no fault or failure within the BIT or BITE will degrade, disrupt, or fail the system being monitored.</p> <p>In the area of software design and test responsibility, the responsibility for the design and development of verification testing of an end item (e.g., digital filter) should reside with the same engineer(s).</p> <p>Define stimuli and response data for each diagnostic test at the system/subsystem level. The same data should be planned for use both in factory testing as well as in field maintenance of the equipment. These data minimize the amount of unique software to be written.</p> <p>Provide for manual control to test sequences, so that the test can be selected individually, and appropriate test combinations can be executed at the operator's discretion.</p>
3.14.02	Built-in Test and Built-in Test Equipment	A-11	
		A-12	
		BIT-01	
		BIT-02	
		BIT-03	
		BIT-04	
		BIT-05	
		BIT-06	
		BIT-07	
		BIT-08	
		BIT-09	
		BIT-10	
		BIT-11	
		BIT-12	
		BIT-13	

Guidelines by Category (Cont'd)

Category No.	Category Title	Guideline No.	Guideline
3.14.02	Built-in Test and Built-in Test Equipment	BIT-14	Provide access to all BIT control and status signals at module connector pins. This will enable ATE to directly connect to BIT circuitry.
		BIT-15	Incorporate complete BIT functions and BITE on module. If only a portion of the BIT routine or BITE circuitry exists on the module, then ATE cannot utilize the BIT routine without providing the missing BIT functions.
		BIT-16	Critical voltages should be visually monitored by sending the voltage signals to visible LEDs.
		BIT-17	BIT failures should be latched on the module. This makes it easier for the system or ATE to poll the error bit at any time.
		BIT-18	If many BIT routines exist on a module, then ATE should have access and the ability to control each routine individually.
		BIT-19	Design BIT to have a very low false alarm rate; otherwise BIT will not be an effective maintenance tool. As a goal, the false alarm rate should be 1% or less.
		BIT-20	The BIT should be mechanized so that when a piece of equipment is not installed in a subsystem or the product, a failure will not be indicated.
		BIT-21	The failure detection function should provide the equipment operator with a go/no-go indication of equipment readiness.
		BIT-22	The BIT should be designed so that auxiliary test devices or external equipment are not needed for daily and other regular checks.
		BIT-23	Design BIT so it is initiated automatically upon equipment power-up.
		BIT-24	Test points should be functionally grouped together and clearly labeled for convenience and ease of maintenance.
		BIT-25	Equipment should not require manual probing to fault isolate.
		BIT-26	Locate routinely used test points so they are accessible without removing or disassembling other equipment
		BIT-27	Periodic and initiated BIT should detect at least 98% of all failures and isolate a minimum 99% of those failures detected to a single LRU or WRA.
		BIT-28	Design BIT to have the same level of EMI protection as the system or equipment being monitored.
		C-01	Avoid swivel type connectors and fittings for air, fuel, or hydraulic line interfaces due to their history of low reliability.
		C-02	Provide spacing between parallel plumbing runs so that in-line couplings can be replaced without removing lines or disconnecting any line support devices.
		CC-01	Use fiber-optic technologies in preference to conventional interconnect concepts to reduce the number of interconnects/interfaces, reduce manufacturing and ownership costs, and significantly improve R&M.
		CC-02	Standardize connector and wire types to improve testability and logistic support. Keep the number of "different" standard connectors to a minimum. Use the same connector type keyed differently where possible.
		CC-03	Provide clearance around connectors for engagement/disengagement of cables and proper connector orientation under anticipated environmental conditions (e.g., bare hand of 50 percentile male in an enclosed or protected environment and a gloved hand of a 50 percentile male in an open or unprotected environment).
		CC-04	Use quick release cables and locate cables to make removal and replacement easy and to avoid having to remove one cable to gain access to another. Provide adequate space for cables, including sleeving and tie-downs, and adequate service loops for ease of assembly/disassembly
		CC-05	Orient and space connectors to allow a sufficient grip on the connector for cable or wire extraction without fear of using the wiring or cable for additional leverage.
		CC-06	Label, and where possible color code, each wire in a harness or cable to facilitate tracking from origin to termination. Each wire, cable, and coax-to-connector interface should be provided with a source of identification to aid in trouble shooting, repair, or modification. Marking the cable designator on the cable along with bar codes is also recommended.
		CC-07	Do not manufacture or dress connectors containing more than 25 wires or cables as a single integrated harness. Group the wires or cables into runs of no more than 25 wires or cables each. In addition to making trouble shooting and repair easier, this approach help avoid large bend radii, thereby simplifying routing, packaging, and stowage.
		CC-08	Standardize connector pin assignments for power, ground, and other frequently used signals.
		CC-09	Locate LRU/subsystem critical nodes (and or test points) so they are accessible from a connector to prevent the need for internal LRU probing or access.

Guidelines by Category (Cont'd)

Category No.	Category Title	Guideline No.	Guideline
3.14.02	Built-in Test and Built-in Test Equipment	CC-10	Avoid hidden cables. Visually inspecting and tracing all assembly cables rather than having hidden cables (such as behind other cables or even LRUs) allows for a quick system and cable integrity check which aids in overall system integrity and debug. This also implies quick access for manipulative actions.
		CC-11	Orient spare wires and cable pigtails along the outer diameter or periphery of connectors to make access easier.
		CC-12	Build up and assemble straight and angle connector shells or back shells in a manner that ensures that wire or cable strain or wear is not possible.
		CO-01	Design automated systems and programs with provisions to enable "stop test" and "resume" without the need to cycle back or repeat the entire test.
		CO-02	In the event of program loss or hang-up, automated systems and programs should have provisions for reverting to manual test and operation.
		CO-03	Use a test connector to provide test and maintenance bus access to all system and subsystem faults.
		CO-04	Design systems and subsystems so that ATE can be used to access, read, and control internal components in concert with the test or checkout program.
		CO-05	Avoid the need for costly adapters for signal communications between system, subsystems, line replaceable units (LRUs) or Weapon Replaceable Assemblies (WRAs), and ATE.
		EC-01	A threaded electrical connector should contain integral locking mechanisms and visual indications that the connector is properly seated and locked.
		EC-02	An electrical connector requiring less than one full turn to connect or disconnect should contain integral locking mechanisms and visual indications that the connector is properly seated and locked.
		EC-03	A push-pull electrical connector (excluding rack-and-panel type) should contain integral locking features and visual indication that the connector is properly seated and locked.
		EC-04	All electrical connectors should be keyed or asymmetrically shaped to ensure proper alignment.
		EC-05	All electrical connectors should contain scoop-proof shells to ensure pin damage will not occur prior to engaging key way.
		EC-06	All electrical connectors should be corrosion resistant to reduce or eliminate the need for scheduled inspections or corrosion prevention measures.
		EC-07	Avoid using electrical connectors requiring any type or form of soldering.
		EC-08	Locate and position electrical connectors such that all pin identification for either half can be easily seen.
		EC-09	Electrical connectors selected for critical applications on ground vehicles should be both accessible and capable of being connected disconnected by a fifty percentile gloved male hand.
		EC-11	Avoid connectors requiring potting as a method for environmental protection due to lengthy repair time and tendency for potting compound reversion.
		EC-12	Electrical penetrations into a compartment should not be on a vertical axis to ensure foreign matter does not enter connector.
		EC-14	Scoop proof connectors should be used throughout unless their use would require an increase in the volume of the aircraft, in which case deviations will be considered on an individual basis.
		EC-15	The removal or replacement of electronic equipment should not require the removal of any other piece of equipment or armament.
		EC-16	Select connectors so that contacts on the "live" or "hot" side of the connection are socket type rather than pin type to minimize personnel hazard and to prevent accidental shorting of live circuits.
		EC-17	Whenever possible, use self-locking connector plugs of a type not requiring safety wire.
		EC-18	All electric connectors should be environment resistant.
		EC-19	Connectors containing fiber optic contacts should, whenever possible, be mounted on a vertical surface to prevent particulate and fluid contamination.
		EC-20	Use quick disconnect connectors where allowed and identify all pins on each connector.
		EC-21	Locate connectors far enough apart so that they meet specified requirements.

Guidelines by Category (Cont'd)

Category No.	Category Title	Guideline No.	Guideline
3.14.02	Built-in Test and Built-in Test Equipment	EC-22	All connectors should be keyed differently with aligning pins that extend beyond the electrical pins. Connector pins and sockets should engage after key position is entered.
		EC-23	Design connectors so that plugs are cold and receptacles are hot.
		EC-24	Use electrical connectors that incorporate alignment key-ways to reduce incidents of damage due to improper engagement.
		EC-25	Use positive locking, quick disconnect electrical connectors to save man-hours, prevent foreign object damage (FOD) and decrease the chance of personal injury.
		EC-26	Avoid using identical electrical connectors in adjacent areas.
		EG-01	Design feedback loops so that the loop can be broken during test to ensure that faults do not propagate to the point where they cannot be isolated.
		EG-02	Avoid using external feedback loops requiring complex circuitry to simulate feedback I/Os.
		EG-03	In rare instances when complex external feedback loops cannot be avoided, incorporate simple interruptible control points.
		EG-04	Avoid long sequences of vectors to initialize or alter device outputs to minimize potential testability problems.
		EG-05	Avoid the need to have test equipment generate complex, phased or time related signals.
		EG-06	Test points should be located on all circuit nodes that are useful in determining the module's health.
		EG-07	Test points should be designed so that functional circuitry cannot be damaged or degraded due to the routing or accidental shorting of a signal at a test point. Some type of test point isolation technique should be used (buffers, isolator, etc.).
		EG-08	Test points should be easily accessed and clearly marked.
		EG-10	Design redundant circuits to be independently testable to ensure errors are not masked.
		EG-11	To improve the probability of fault detection, avoid shorting signals together to achieve a specific test function or condition.
		EG-12	Incorporate concept for partitioning module functions to simplify test equipment or eliminate the need for ancillary test equipment.
		EG-13	Design oscillators or clocks that are resident on the module to be replaceable by a signal from a connector to avoid the need to synchronize ATE to on-board signals.
		ENG(G)-18	Incorporate appropriate sensors to enhance the diagnostic and prognostic capabilities for the following: <ul style="list-style-type: none"> - Oil temperature - Oil pressure - Oil filter bypass - Oil cooler bypass valve position - Oil level - Oil return line particle count
		ENG-01	All facets of engine design should take advantage of Electrostatic Engine Monitoring Systems (EEMS) and Inductive Debris Monitoring (IDM) toward achievement of on-condition maintenance and engine health monitoring.
		ENG-02	Each different component of rotating machinery should contain different tracer elements to enhance EEMS and IDM isolation and tracking of wear.
		ENG-03	Digital electronic controls, fully automatic digital electronic controls, and similar concepts should contain the highest degree of BIT and diagnostics commensurate with affordability, operation and maintenance, and life cycle costs as appropriate.
		ENG-23	All engine borescope provisions should be accessible with the engine installed and hooked up.
		ENG-26	Locate and position engine overheat and fire warning sensors so that damage cannot occur during engine maintenance or replacement.
		ENV-06	For ground vehicles, the finishes should be compatible with and durable against all rain, hail, sleet, snow, and ice conditions experienced in all intended operational environments.
		FI-01	Design each FI test to be independent of all other tests.

Guidelines by Category (Cont'd)

Category No.	Category Title	Guideline No.	Guideline
3.14.02	Built-in Test and Built-in Test Equipment		
		FI-02	Design FI initiation to be subordinate to the higher priority predecessor tests.
		FI-03	Design each test so that it can be terminated prior to completion and then re-initiated at its start point.
		FI-04	Design the unit tests so that they can accommodate the following subsystem response modes: <ul style="list-style-type: none"> - Incorrect response - No response - Inconsistent response - Unexpected condition
		FI-05	Design all software so that it is structured by test priority. The test software should take advantage of both subroutine constructs for all message outputs and of failure dictionaries which identify the location of the most likely failed replaceable unit.
		FI-06	In an airborne avionics system, consider indicating mission critical faults on a pilots "head-up" display accompanied with an audible alarm, so that the pilot can easily check for critical system or mission threatening problems.
		FI-07	Ensure that system user manuals include instructions for faults not covered by BIT such as, system will not power up or system is being used in an incorrect environment such as, at the wrong altitude, etc.
		FI-08	Interlock the high power sections of systems and subsystems with visual/audible BIT to ensure safe system activation.
		FI-09	Design BIT to first conduct self-test for circuitry integrity before conducting system test.
		FI-10	Use clear text to report failures rather than alpha-numeric codes, lights, indicators, etc.
		FI-11	Locate BIT circuitry on the same level of the subsystem under test to simplify test and repair when it is removed from the main system.
		MC-06	Locate, position, orient all plumbing and duct electrical connectors to prevent the need for sequential installation or removal.
		MC-12	All plumbing and connectors containing liquids should be meniscus-free.
		MC-13	In instances where plumbing or connector interfaces cannot or are not keyed for a specific orientation, all identification, markings, cautions, and directions should be placed 360 degrees around the tube or duct.
		MC-14	Where multiple connectors are located in close proximity, ensure (1) a minimum hand tool arc of 120 degrees can be maintained, and (2) stagger fittings to ensure firm coupling interface/hand tool interface can be accomplished without inducing damage to adjacent lines.
		MG-01	Mount LRUs/sub-systems on drawer slides or extender racks to provide easier accessibility during integration, testing, debug, and repair of Units Under Test (UUTs).
		MG-02	Use a modular system design so that each subassembly is designed as a functionally complete entity. Then when a subassembly was removed for testing, ATE will not need custom circuitry to simulate missing functions.
		MG-03	Clearly mark all subsystems/LRUs to make system integration, test, debug, and repair easier.
		MP-01	Avoid the use epoxies to mount parts on repairable modules because they make repair extremely difficult.
		MP-02	Use a unique identification (ID) resistor incorporated in each system module to verify that the proper module is mounted on ATE.
		MP-03	Design modules so that lengthy warm-up times, special coding and air purity levels, and similar constraints are not necessary.
		SI-03	Parts and assemblies of a given model product or of models of a product in the same series should be interchangeable or replaceable.
		TP-01	Locate Input/Output (I/O) test points and associated readouts in close proximity to each other so that one person can perform testing.
		TP-02	Protect test points against the environment and from induced contamination.
		TP-03	Protect test points from outside signal generation.
		W-01	Hat section type structural stiffeners with sufficient cross sectional area should be considered as a routing tunnel for wiring and coax.

Guidelines by Category (Cont'd)

Category No.	Category Title	Guideline No.	Guideline
3.14.03	External Test Equipment	A-18	Use transparent windows, quick-opening covers, or openings without any cover to permit quick visual inspections where needed.
		BIT-01	During design of the BIT, use worst-case stress analysis to ensure that any circuit failures induced by temperature extremes, tolerance build-up, power supply variations, and combinations thereof are identified.
		BIT-02	Ensure that BIT system thresholds are consistent with those across the system, subsystem, item, module, and piece-part levels to prevent excessive numbers of Cannot Duplicate (CND) and Retest OK (RTOK) events from occurring.
		BIT-03	The degree of BIT required or proposed should be based on the respective failure rates and the appropriate FMECA at all equipment indenture levels.
		BIT-04	Limit the amount of data that is recorded to a manageable size by: <ul style="list-style-type: none"> - Limiting the number of signals that are monitored - Limiting the maximum sampling rate - Reducing the time span over which data is accumulated - Restricting the type of data accumulated
		BIT-05	Incorporate testability design features as an integral part of equipment preliminary design process.
		BIT-06	Mission critical functions should be monitored by BIT.
		BIT-07	Set BIT tolerances to maximize fault detection and minimize false alarm rate in the expected operating environment.
		BIT-08	Design BIT fault detectors to accommodate the needs of operator maintenance personnel.
		BIT-09	Use concurrent BIT to monitor system critical functions.
		BIT-10	Design the BIT and BITE so that no fault or failure within the BIT or BITE will degrade, disrupt, or fail the system being monitored.
		BIT-11	In the area of software design and test responsibility, the responsibility for the design and development of verification testing of an end item (e.g, digital filter) should reside with the same engineer(s).
		BIT-12	Define stimuli and response data for each diagnostic test at the system/subsystem level. The same data should be planned for use both in factory testing as well as in field maintenance of the equipment. These data minimize the amount of unique software to be written.
		BIT-13	Provide for manual control to test sequences, so that the test can be selected individually, and appropriate test combinations can be executed at the operator's discretion.
		BIT-14	Provide access to all BIT control and status signals at module connector pins. This will enable ATE to directly connect to BIT circuitry.
		BIT-15	Incorporate complete BIT functions and BITE on module. If only a portion of the BIT routine or BITE circuitry exists on the module, then ATE cannot utilize the BIT routine without providing the missing BIT functions.
		BIT-16	Critical voltages should be visually monitored by sending the voltage signals to visible LEDs.
		BIT-17	BIT failures should be latched on the module. This makes it easier for the system or ATE to poll the error bit at any time.
		BIT-18	If many BIT routines exist on a module, then ATE should have access and the ability to control each routine individually.
		BIT-19	Design BIT to have a very low false alarm rate; otherwise BIT will not be an effective maintenance tool. As a goal, the false alarm rate should be 1% or less.
		BIT-20	The BIT should be mechanized so that when a piece of equipment is not installed in a subsystem or the product, a failure will not be indicated.
		BIT-21	The failure detection function should provide the equipment operator with a go/no-go indication of equipment readiness.
		BIT-22	The BIT should be designed so that auxiliary test devices or external equipment are not needed for daily and other regular checks.
		BIT-23	Design BIT so it is initiated automatically upon equipment power-up.
		BIT-24	Test points should be functionally grouped together and clearly labeled for convenience and ease of maintenance.
		BIT-25	Equipment should not require manual probing to fault isolate.
		BIT-27	Periodic and initiated BIT should detect at least 98% of all failures and isolate a minimum 99% of those failures detected to a single LRU or WRA.

Guidelines by Category (Cont'd)

Category No.	Category Title	Guideline No.	Guideline
3.14.03	External Test Equipment		
		BIT-28 BIT/BITE-01	Design BIT to have the same level of EMI protection as the system or equipment being monitored. Design to keep false alarm rates below 1%. Higher false alarm rates can limit the effectiveness of BIT as a maintenance tool.
		BIT/BITE-02	Design EMI protection to eliminate finger type EMI contact devices.
		C-01	Avoid swivel type connectors and fittings for air, fuel, or hydraulic line interfaces due to their history of low reliability.
		C-02	Provide spacing between parallel plumbing runs so that in-line couplings can be replaced without removing lines or disconnecting any line support devices.
		CC-01	Use fiber-optic technologies in preference to conventional interconnect concepts to reduce the number of interconnects/interfaces, reduce manufacturing and ownership costs, and significantly improve R&M.
		CC-02	Standardize connector and wire types to improve testability and logistic support. Keep the number of "different" standard connectors to a minimum. Use the same connector type keyed differently where possible.
		CC-03	Provide clearance around connectors for engagement/disengagement of cables and proper connector orientation under anticipated environmental conditions (e.g., bare hand of 50 percentile male in an enclosed or protected environment and a gloved hand of a 50 percentile male in an open or unprotected environment).
		CC-04	Use quick release cables and locate cables to make removal and replacement easy and to avoid having to remove one cable to gain access to another. Provide adequate space for cables, including sleeving and tie-downs, and adequate service loops for ease of assembly/disassembly.
		CC-05	Orient and space connectors to allow a sufficient grip on the connector for cable or wire extraction without fear of using the wiring or cable for additional leverage.
		CC-06	Label, and where possible color code, each wire in a harness or cable to facilitate tracking from origin to termination. Each wire, cable, and coax-to-connector interface should be provided with a source of identification to aid in trouble shooting, repair, or modification. Marking the cable designator on the cable along with bar codes is also recommended.
		CC-07	Do not manufacture or dress connectors containing more than 25 wires or cables as a single integrated harness. Group the wires or cables into runs of no more than 25 wires or cables each. In addition to making trouble shooting and repair easier, this approach help avoid large bend radii, thereby simplifying routing, packaging, and stowage.
		CC-08	Standardize connector pin assignments for power, ground, and other frequently used signals.
		CC-09	Locate LRU/subsystem critical nodes (and or test points) so they are accessible from a connector to prevent the need for internal LRU probing or access.
		CC-10	Avoid hidden cables. Visually inspecting and tracing all assembly cables rather than having hidden cables (such as behind other cables or even LRUs) allows for a quick system and cable integrity check which aids in overall system integrity and debug. This also implies quick access for manipulative actions.
		CC-11	Orient spare wires and cable pigtails along the outer diameter or periphery of connectors to make access easier.
		CC-12	Build up and assemble straight and angle connector shells or back shells in a manner that ensures that wire or cable strain or wear is not possible.
		CO-01	Design automated systems and programs with provisions to enable "stop test" and "resume" without the need to cycle back or repeat the entire test.
		CO-02	In the event of program loss or hang-up, automated systems and programs should have provisions for reverting to manual test and operation.
		CO-03	Use a test connector to provide test and maintenance bus access to all system and subsystem faults.
		CO-04	Design systems and subsystems so that ATE can be used to access, read, and control internal components in concert with the test or checkout program.
		CO-05	Avoid the need for costly adapters for signal communications between system, subsystems, line replaceable units (LRUs) or Weapon Replaceable Assemblies (WRAs), and ATE.
		CONT-01	Control rods should use Boyd or impedance type bolts (or equivalent) to eliminate the need for cotter pins or safety wire.
		CONT-02	Do not use metal control cables for vehicles that will operate in salt water or salt air environments.
		CONT-03	Use control rods rather than control cables for non-complex applications and non-complex routing within the vehicle.
		CONT-04	Use control cables rather than control rods for most complex applications.

Guidelines by Category (Cont'd)

Category No.	Category Title	Guideline No.	Guideline
3.14.03	External Test Equipment		
		CONT-05	Route cables so that 100 percent of a cable will be viewable for inspection.
		CONT-06	Design all pulleys and brackets associated with cable installations so they are accessible by a 75 percentile male hand.
		CREW-12	Requirements for boresighting should not be part of the design or integration.
		EC-01	A threaded electrical connector should contain integral locking mechanisms and visual indications that the connector is properly seated and locked.
		EC-02	An electrical connector requiring less than one full turn to connect or disconnect should contain integral locking mechanisms and visual indications that the connector is properly seated and locked.
		EC-03	A push-pull electrical connector (excluding rack-and-panel type) should contain integral locking features and visual indication that the connector is properly seated and locked.
		EC-04	All electrical connectors should be keyed or asymmetrically shaped to ensure proper alignment.
		EC-05	All electrical connectors should contain scoop-proof shells to ensure pin damage will not occur prior to engaging key way.
		EC-06	All electrical connectors should be corrosion resistant to reduce or eliminate the need for scheduled inspections or corrosion prevention measures.
		EC-07	Avoid using electrical connectors requiring any type or form of soldering.
		EC-08	Locate and position electrical connectors such that all pin identification for either half can be easily seen.
		EC-09	Electrical connectors selected for critical applications on ground vehicles should be both accessible and capable of being connected disconnected by a fifty percentile gloved male hand.
		EC-10	Separation between grouped electrical connectors should be sufficient to ensure make or break of any connector by a fifty percentile gloved male hand. Where this is not possible, an alternate method should be used such as the use of stand-offs, long-shelled connectors alternated with standard connectors, 180-degree connectors alternated with 90-degree connectors, or innovative equivalents.
		EC-11	Avoid connectors requiring potting as a method for environmental protection due to lengthy repair time and tendency for potting compound reversion.
		EC-12	Electrical penetrations into a compartment should not be on a vertical axis to ensure foreign matter does not enter connector.
		EC-14	Scoop proof connectors should be used throughout unless their use would require an increase in the volume of the aircraft, in which case deviations will be considered on an individual basis.
		EC-15	The removal or replacement of electronic equipment should not require the removal of any other piece of equipment or armament.
		EC-16	Select connectors so that contacts on the "live" or "hot" side of the connection are socket type rather than pin type to minimize personnel hazard and to prevent accidental shorting of live circuits.
		EC-17	Whenever possible, use self-locking connector plugs of a type not requiring safety wire.
		EC-18	All electric connectors should be environment resistant.
		EC-19	Connectors containing fiber optic contacts should, whenever possible, be mounted on a vertical surface to prevent particle and fluid contamination.
		EC-20	Use quick disconnect connectors where allowed and identify all pins on each connector.
		EG-01	Design feedback loops so that the loop can be broken during test to ensure that faults do not propagate to the point where they cannot be isolated.
		EG-02	Avoid using external feedback loops requiring complex circuitry to simulate feedback I/Os.
		EG-03	In rare instances when complex external feedback loops cannot be avoided, incorporate simple interruptible control points.
		EG-04	Avoid long sequences of vectors to initialize or alter device outputs to minimize potential testability problems.
		EG-05	Avoid the need to have test equipment generate complex, phased or time related signals.
		EG-06	Test points should be located on all circuit nodes that are useful in determining the module's health.

Guidelines by Category (Cont'd)

Category No.	Category Title	Guideline No.	Guideline
3.14.03	External Test Equipment	EG-07	Test points should be designed so that functional circuitry cannot be damaged or degraded due to the routing or accidental shorting of a signal at a test point. Some type of test point isolation technique should be used (buffers, isolator, etc.).
		EG-08	Test points should be easily accessed and clearly marked.
		EG-10	Design redundant circuits to be independently testable to ensure errors are not masked.
		EG-11	To improve the probability of fault detection, avoid shorting signals together to achieve a specific test function or condition.
		EG-12	Incorporate concept for partitioning module functions to simplify test equipment or eliminate the need for ancillary test equipment.
		EG-13	Design oscillators or clocks that are resident on the module to be replaceable by a signal from a connector to avoid the need to synchronize ATE to on-board signals.
		ENG-23	All engine borescope provisions should be accessible with the engine installed and hooked up.
		ENV-01	Materials, treatments, coatings, finishes should be compatible with all anti-ice and de-ice fluids, chemical and biological decontamination fluids, washing and cleaning fluids, and all vehicle subsystem fluids.
		ENV-04	For airborne and ground vehicles, the finishes should be durable against sand erosion throughout all surface wind speeds experienced in arid or desert geographical locations.
		ENV-07	The finishes and surfaces should be capable of low velocity impact (LVI) of 10 foot-pounds with no visual or detectable damage with a design goal of 30 foot-pounds.
		FI-01	Design each FI test to be independent of all other tests.
		FI-02	Design FI initiation to be subordinate to the higher priority predecessor tests.
		FI-03	Design each test so that it can be terminated prior to completion and then re-initiated at its start point.
		FI-04	Design the unit tests so that they can accommodate the following subsystem response modes: - Incorrect response - No response - Inconsistent response - Unexpected condition
		FI-05	Design all software so that it is structured by test priority. The test software should take advantage of both subroutine constructs for all message outputs and of failure dictionaries which identify the location of the most likely failed replaceable unit.
		FI-06	In an airborne avionics system, consider indicating mission critical faults on a pilots "head-up" display accompanied with an audible alarm, so that the pilot can easily check for critical system or mission threatening problems.
		FI-07	Ensure that system user manuals include instructions for faults not covered by BIT such as, system will not power up or system is being used in an incorrect environment such as, at the wrong altitude, etc.
		FI-08	Interlock the high power sections of systems and subsystems with visual/audible BIT to ensure safe system activation.
		FI-09	Design BIT to first conduct self-test for circuitry integrity before conducting system test.
		FI-10	Use clear text to report failures rather than alpha-numeric codes, lights, indicators, etc.
		FI-11	Locate BIT circuitry on the same level of the subsystem under test to simplify test and repair when it is removed from the main system.
		MC-01	All clamps should contain torque-set or torque-limiting connections to prevent clamp or component failure due to over-torque. Clamp installation call outs should not depend on special tools to establish the required torque values.
		MC-02	Avoid the use of cotter pins, safety wire, safety clips, and similar devices to prevent maintenance-induced events leading to ground vehicle accidents or loss of air vehicles.
		MC-03	All tubing connections and interfaces should use rosan/dynatube (or equivalent) to (1) enable connect or disconnect with one hand, one tool, (2) eliminate the need to safety the connection, (3) provide a superior seal, and (4) negate need to reposition line(s) during component replacement.
		MC-04	No trombone type, flared tube type, or piloted line type interfaces should be used to avoid the need for removal or repositioning during equipment removal.

Guidelines by Category (Cont'd)

Category No.	Category Title	Guideline No.	Guideline		
3.14.03	External Test Equipment	MC-05	Avoid potential foreign object traps during manufacturing or operational maintenance by eliminating vertical penetrations of plumbing/fittings into tanks, compartments, or cells		
		MC-06	Locate, position, orient all plumbing and duct electrical connectors to prevent the need for sequential installation or removal.		
		MC-11	No subsystem plumbing, equipment, or wiring should use a tank, cell, or compartment containing liquids as a means for routing or penetration simplicity during manufacture.		
		MC-12	All plumbing and connectors containing liquids should be meniscus-free.		
		MC-13	In instances where plumbing or connector interfaces cannot or are not keyed for a specific orientation, all identification, markings, cautions, and directions should be placed 360 degrees around the tube or duct.		
		MC-14	Where multiple connectors are located in close proximity, ensure (1) a minimum hand tool arc of 120 degrees can be maintained, and (2) stagger fittings to ensure firm coupling interface/hand tool interface can be accomplished without inducing damage to adjacent lines.		
		MG-01	Mount LRUs/sub-systems on drawer slides or extender racks to provide easier accessibility during integration, testing, debug, and repair of Units Under Test (UUTs).		
		MG-02	Use a modular system design so that each subassembly is designed as a functionally complete entity. Then when a subassembly was removed for testing, ATE will not need custom circuitry to simulate missing functions.		
		MG-03	Clearly mark all subsystems/LRUs to make system integration, test, debug, and repair easier.		
		MP-01	Avoid the use of epoxies to mount parts on repairable modules because they make repair extremely difficult.		
		MP-02	Use a unique identification (ID) resistor incorporated in each system module to verify that the proper module is mounted on ATE.		
		MP-03	Design modules so that lengthy warm-up times, special coding and air purity levels, and similar constraints are not necessary.		
		SI-03	Parts and assemblies of a given model product or of models of a product in the same series should be interchangeable or replaceable.		
		TP-01	Locate Input/Output (I/O) test points and associated readouts in close proximity to each other so that one person can perform testing.		
		TP-02	Protect test points against the environment and from induced contamination.		
		TP-03	Protect test points from outside signal generation.		
		W-01	Hat section type structural stiffeners with sufficient cross sectional area should be considered as a routing tunnel for wiring and coax.		
		3.15	Man-Machine Interfaces	A-07	Paint equipment bay and compartment interiors a high gloss white to maximize lighting reflectivity, visibility, and rapid leak detection capability.
		A-13	Two-sided or two-surfaced access should not be required for access to equipment interfaces and hardpoints. The term two-sided infers top/bottom, left/right, front/back, or combinations thereof.		
		A-14	Do not locate nutplates or gang channels in inaccessible areas that would require extensive disassembly or equipment removal to gain access.		
		A-15	Locate tie-down attachment points such that tie-down chains, straps, or cables do not prevent or restrict normal servicing, weapon loading, or safe/arm functions.		
A-16	Structural design should provide good access to corrosion-prone areas for inspection and treatment.				
A-18	Use transparent windows, quick-opening covers, or openings without any cover to permit quick visual inspections where needed.				
ARM-01	For an aircraft, the fuselage lower shear moldline should be no less than 38" above the ground when external weapons only will be carried on the fuselage.				
ARM-02	For an aircraft, the fuselage lower shear moldline should be no less than 50" above the ground when internal weapons will be carried in the fuselage and weapon bay door widths exceed 22".				
BIT-05	Incorporate testability design features as an integral part of equipment preliminary design process.				

Guidelines by Category (Cont'd)

Category No.	Category Title	Guideline No.	Guideline
3.15	Man-Machine Interfaces		
		BIT-06	Mission critical functions should be monitored by BIT.
		BIT-09	Use concurrent BIT to monitor system critical functions.
		BIT-20	The BIT should be mechanized so that when a piece of equipment is not installed in a subsystem or the product, a failure will not be indicated.
		BIT-26	Locate routinely used test points so they are accessible without removing or disassembling other equipment
		BIT-27	Periodic and initiated BIT should detect at least 98% of all failures and isolate a minimum 99% of those failures detected to a single LRU or WRA.
		BIT-28	Design BIT to have the same level of EMI protection as the system or equipment being monitored.
		BIT/BITE-01	Design to keep false alarm rates below 1%. Higher false alarm rates can limit the effectiveness of BIT as a maintenance tool.
		BIT/BITE-02	Design EMI protection to eliminate finger type EMI contact devices.
		CC-01	Use fiber-optic technologies in preference to conventional interconnect concepts to reduce the number of interconnects/interfaces, reduce manufacturing and ownership costs, and significantly improve R&M.
		CC-02	Standardize connector and wire types to improve testability and logistic support. Keep the number of "different" standard connectors to a minimum. Use the same connector type keyed differently where possible.
		CC-03	Provide clearance around connectors for engagement/disengagement of cables and proper connector orientation under anticipated environmental conditions (e.g., bare hand of 50 percentile male in an enclosed or protected environment and a gloved hand of a 50 percentile male in an open or unprotected environment).
		CC-04	Use quick release cables and locate cables to make removal and replacement easy and to avoid having to remove one cable to gain access to another. Provide adequate space for cables, including sleeving and tie-downs, and adequate service loops for ease of assembly/disassembly
		CC-05	Orient and space connectors to allow a sufficient grip on the connector for cable or wire extraction without fear of using the wiring or cable for additional leverage.
		CC-06	Label, and where possible color code, each wire in a harness or cable to facilitate tracking from origin to termination. Each wire, cable, and coax-to-connector interface should be provided with a source of identification to aid in trouble shooting, repair, or modification. Marking the cable designator on the cable along with bar codes is also recommended.
		CC-07	Do not manufacture or dress connectors containing more than 25 wires or cables as a single integrated harness. Group the wires or cables into runs of no more than 25 wires or cables each. In addition to making trouble shooting and repair easier, this approach help avoid large bend radii, thereby simplifying routing, packaging, and stowage.
		CC-08	Standardize connector pin assignments for power, ground, and other frequently used signals.
		CC-09	Locate LRU/subsystem critical nodes (and or test points) so they are accessible from a connector to prevent the need for internal LRU probing or access.
		CC-10	Avoid hidden cables. Visually inspecting and tracing all assembly cables rather than having hidden cables (such as behind other cables or even LRUs) allows for a quick system and cable integrity check which aids in overall system integrity and debug. This also implies quick access for manipulative actions.
		CC-11	Orient spare wires and cable pigtails along the outer diameter or periphery of connectors to make access easier.
		CC-12	Build up and assemble straight and angle connector shells or back shells in a manner that ensures that wire or cable strain or wear is not possible.
		CO-03	Use a test connector to provide test and maintenance bus access to all system and subsystem faults.
		CO-05	Avoid the need for costly adapters for signal communications between system, subsystems, line replaceable units (LRUs) or Weapon Replaceable Assemblies (WRAs), and ATE.
		CONT-01	Control rods should use Boyd or impedance type bolts (or equivalent) to eliminate the need for cotter pins or safety wire.
		CONT-02	Do not use metal control cables for vehicles that will operate in salt water or salt air environments.
		CONT-03	Use control rods rather than control cables for non-complex applications and non-complex routing within the vehicle.
		CONT-04	Use control cables rather than control rods for most complex applications.
		CONT-05	Route cables so that 100 percent of a cable will be viewable for inspection.

MIL-HDBK-470A

APPENDIX C

Guidelines by Category (Cont'd)

Category No.	Category Title	Guideline No.	Guideline
3.15	Man-Machine Interfaces		
		CON7-06	Design all pulleys and brackets associated with cable installations so they are accessible by a 75 percentile male hand.
		EC-01	A threaded electrical connector should contain integral locking mechanisms and visual indications that the connector is properly seated and locked.
		EC-02	An electrical connector requiring less than one full turn to connect or disconnect should contain integral locking mechanisms and visual indications that the connector is properly seated and locked.
		EC-03	A push-pull electrical connector (excluding rack-and-panel type) should contain integral locking features and visual indication that the connector is properly seated and locked.
		EC-04	All electrical connectors should be keyed or asymmetrically shaped to ensure proper alignment.
		EC-05	All electrical connectors should contain scoop-proof shells to ensure pin damage will not occur prior to engaging key way.
		EC-06	All electrical connectors should be corrosion resistant to reduce or eliminate the need for scheduled inspections or corrosion prevention measures.
		EC-07	Avoid using electrical connectors requiring any type or form of soldering.
		EC-08	Locate and position electrical connectors such that all pin identification for either half can be easily seen.
		EC-09	Electrical connectors selected for critical applications on ground vehicles should be both accessible and capable of being connected disconnected by a fifty percentile gloved male hand.
		EC-10	Separation between grouped electrical connectors should be sufficient to ensure make or break of any connector by a fifty percentile gloved male hand. Where this is not possible, an alternate method should be used such as the use of stand-offs, long-shelled connectors, alternated with standard connectors, 180-degree connectors alternated with 90-degree connectors, or innovative equivalents.
		EC-11	Avoid connectors requiring potting as a method for environmental protection due to lengthy repair time and tendency for potting compound reversion.
		EC-12	Electrical penetrations into a compartment should not be on a vertical axis to ensure foreign matter does not enter connector.
		EC-14	Scoop proof connectors should be used throughout unless their use would require an increase in the volume of the aircraft, in which case deviations will be considered on an individual basis.
		EC-16	Select connectors so that contacts on the "live" or "hot" side of the connection are socket type rather than pin type to minimize personnel hazard and to prevent accidental shorting of live circuits.
		EC-17	Whenever possible, use self-locking connector plugs of a type not requiring safety wire.
		EC-18	All electric connectors should be environment resistant.
		EC-21	Locate connectors far enough apart so that they meet specified requirements.
		EC-22	All connectors should be keyed differently with aligning pins that extend beyond the electrical pins. Connector pins and sockets should engage after key position is entered.
		EC-23	Design connectors so that plugs are cold and receptacles are hot.
		EC-24	Use electrical connectors that incorporate alignment key-ways to reduce incidents of damage due to improper engagement.
		EC-25	Use positive locking, quick disconnect electrical connectors to save man-hours, prevent foreign object damage (FOD) and decrease the chance of personal injury.
		EC-26	Avoid using identical electrical connectors in adjacent areas.
		EG-01	Design feedback loops so that the loop can be broken during test to ensure that faults do not propagate to the point where they cannot be isolated.
		EG-02	Avoid using external feedback loops requiring complex circuitry to simulate feedback I/Os.
		EG-03	In rare instances when complex external feedback loops cannot be avoided, incorporate simple interruptible control points.
		EG-04	Avoid long sequences of vectors to initialize or alter device outputs to minimize potential testability problems.
		EG-05	Avoid the need to have test equipment generate complex, phased or time related signals.

Guidelines by Category (Cont'd)

Category No.	Category Title	Guideline No.	Guideline
3.15	Man-Machine Interfaces		
		EG-06	Test points should be located on all circuit nodes that are useful in determining the module's health.
		EG-07	Test points should be designed so that functional circuitry cannot be damaged or degraded due to the routing or accidental shorting of a signal at a test point. Some type of test point isolation technique should be used (buffers, isolator, etc.).
		EG-08	Test points should be easily accessed and clearly marked.
		EG-10	Design redundant circuits to be independently testable to ensure errors are not masked.
		EG-11	To improve the probability of fault detection, avoid shorting signals together to achieve a specific test function or condition.
		EG-12	Incorporate concept for partitioning module functions to simplify test equipment or eliminate the need for ancillary test equipment..
		EG-13	Design oscillators or clocks that are resident on the module to be replaceable by a signal from a connector to avoid the need to synchronize ATE to on-board signals.
		ENV-01	Materials, treatments, coatings, finishes should be compatible with all anti-ice and de-ice fluids, chemical and biological decontamination fluids, washing and cleaning fluids, and all vehicle subsystem fluids.
		F-01	Use blind fasteners only where absolutely necessary or where considerable cost can be saved.
		F-02	Minimize access fasteners while making them quick release, easily removed and replaced, and captive.
		F-03	Choose fasteners based on the requirement to operate by hand or with common hand tools rather than special tools.
		F-04	Whenever possible, incorporate barrel type fasteners as opposed to hi-torque fasteners. Failure of Hi-torque fasteners due to stripping are common and a source of potential foreign object damage (FOD).
		FI-01	Design each FI test to be independent of all other tests.
		FI-02	Design FI initiation to be subordinate to the higher priority predecessor tests.
		FI-03	Design each test so that it can be terminated prior to completion and then re-initiated at its start point.
		FI-04	Design the unit tests so that they can accommodate the following subsystem response modes: - Incorrect response - No response - Inconsistent response - Unexpected condition
		FI-05	Design all software so that it is structured by test priority. The test software should take advantage of both subroutine constructs for all message outputs and of failure dictionaries which identify the location of the most likely failed replaceable unit.
		FI-06	In an airborne avionics system, consider indicating mission critical faults on a pilots "head-up" display accompanied with an audible alarm, so that the pilot can easily check for critical system or mission threatening problems.
		FI-07	Ensure that system user manuals include instructions for faults not covered by BIT such as, system will not power up or system is being used in an incorrect environment such as, at the wrong altitude, etc.
		FI-08	Interlock the high power sections of systems and subsystems with visual/audible BIT to ensure safe system activation.
		FI-09	Design BIT to first conduct self-test for circuitry integrity before conducting system test.
		FI-10	Use clear text to report failures rather than alpha-numeric codes, lights, indicators, etc.
		FI-11	Locate BIT circuitry on the same level of the subsystem under test to simplify test and repair when it is removed from the main system.
		HF-01	Steps and handholds for all ground vehicles should be parasitic to the surface and capable of safely supporting a 95 percentile male wearing arctic boots.
		HF-03	Provide hoist fittings or hardpoints for hoist fitting attachments that are readily accessible.
		HF-04	Size structural openings into man-rated fuel cells to enable entry by a 75 percentile male.
		HF-05	In designing the vehicle, system, subsystem, and equipment, attempt to satisfy the personnel spectrum from the 5th percentile female to the 95th percentile male.

Guidelines by Category (Cont'd)

Category No.	Category Title	Guideline No.	Guideline
3.15	Man-Machine Interfaces	HF-06	<p>Recognize that design ingenuity cannot overcome the fact that certain tasks may be outside of the capabilities of females in the lower percentile ranges. Many of these tasks may also be outside the capability of a large portion of the male lower percentile ranges. In designing, proactively recognize these disabilities so the necessary scope and depth of good design tradeoffs can be identified or expanded. The tasks include:</p> <ul style="list-style-type: none"> - Manually loading many types of weapons. - Pushing an engine/transport trailer combination. - Handling various large actuators, motors, or generators. - Removing, installing, and handling many built-up wheel and tire assemblies. - Lifting a large percentage of avionics - Reaching all areas of windshield/canopy surfaces for cleaning. - Moving major support equipment. - Handling tie-down chains. - Lifting or removing pinched chocks. - Lifting tool boxes. - Aiding in pilot rescue. - Safely moving about in high over-the-deck or ground surface winds. - Riding brakes or taxiing aircraft. - Lifting and connecting refueling hoses. - Changing or repairing tank treads. - Handling small ammunition containers. - Achieving high torque values.
		HF-07	<p>Recognize that design ingenuity cannot overcome certain tasks that are not within the capability of the 95 percentile male. In designing, proactively recognize these disabilities so the necessary scope and depth of good design tradeoffs can be identified or expanded. The tasks include:</p> <ul style="list-style-type: none"> - Pulling circuit breakers with a gloved hand. - Achieving good working access inside of many equipment bays and compartments. - Working under air vehicles with lower shears less than 32 inches above the static ground line. - Connecting and disconnecting electrical connectors that are generally considered to be sufficiently spaced. - Recovering a dropped tool from many different bays and compartments. - Preparing many different types of vehicles for operation while wearing arctic clothing or chemical/biological protective gear.
		HF-08	<p>Avoid solely relying on decals, placards, or instruction media to simplify or negate redesign. In rare instances such use of decals, etc. may lead to significant payoffs, the decision should be supported by complete analysis and supporting rationale.</p>
		HF-09	<p>Develop decals, placards and instruction media around an 8th grade reading level and a 10th grade level of comprehension.</p>
		MC-01	<p>All clamps should contain torque-set or torque-limiting connections to prevent clamp or component failure due to over-torque. Clamp installation call outs should not depend on special tools to establish the required torque values.</p>
		MC-02	<p>Avoid the use of cotter pins, safety wire, safety clips, and similar devices to prevent maintenance-induced events leading to ground vehicle accidents or loss of air vehicles.</p>
		MC-03	<p>All tubing connections and interfaces should use rosan/dynatube (or equivalent) to (1) enable connect or disconnect with one hand, one tool, (2) eliminate the need to safety the connection, (3) provide a superior seal, and (4) negate need to reposition line(s) during component replacement.</p>
		MC-04	<p>No trombone type, flared tube type, or piloted line type interfaces should be used to avoid the need for removal or repositioning during equipment removal.</p>
		MC-05	<p>Avoid potential foreign object traps during manufacturing or operational maintenance by eliminating vertical penetrations of plumbing/fittings into tanks, compartments, or cells</p>
		MC-06	<p>Locate, position, orient all plumbing and duct electrical connectors to prevent the need for sequential installation or removal.</p>

Guidelines by Category (Cont'd)

Category No.	Category Title	Guideline No.	Guideline
3.15	Man-Machine Interfaces		
		MC-09	All plumbing connections and fittings used for fuel systems should contain integral bonding features to eliminate the need for bonding clamps or jumper cables.
		MC-10	In rare instances where a plumbing run contains complex form or geometry that would require removal of other plumbing or equipment for access, in-line connectors should be incorporated to maintain the integrity of other plumbing or equipment.
		MC-11	No subsystem plumbing, equipment, or wiring should use a tank, cell, or compartment containing liquids as a means for routing or penetration simplicity during manufacture.
		MC-12	All plumbing and connectors containing liquids should be meniscus-free.
		MC-13	In instances where plumbing or connector interfaces cannot or are not keyed for a specific orientation, all identification, markings, cautions, and directions should be placed 360 degrees around the tube or duct.
		MC-14	Where multiple connectors are located in close proximity, ensure (1) a minimum hand tool arc of 120 degrees can be maintained, and (2) stagger fittings to ensure firm coupling interface/hand tool interface can be accomplished without inducing damage to adjacent lines.
		MG-03	Clearly mark all subsystems/LRUs to make system integration, test, debug, and repair easier.
		PERS-01	Group man-machine interfaces manifold-style to enable connect/disconnect in a single action.
		PERS-02	Include an integral, highly visible indicator in a man-machine interface connector to denote connector is seated and locked.
		PERS-03	Design interface connectors so that a distinct action is required by an individual to effect a disconnect. (Excludes airframe-to-ejection seat personnel interfaces.)
		PERS-04	Interfaces should contain an emergency release mechanism that can be activated by rescue personnel with a 95 percentile gloved hand.
		PERS-05	Design emergency interface release mechanisms to be clearly visible under all types of lighting situations.
		PERS-06	Storage bins, compartments, sacks, or bags should be available within the vehicle to store/protect all personal equipment required to conduct operations.
		PERS-07	All flight and ground vehicles should contain one cubic foot minimum storage compartment(s) for various loose and sundry personal items (for each individual).
		PERS-08	Design stowage and mounting provisions for portable air or oxygen containers to withstand 40G crash or impact loads.
		PRYO-03	Provide the pilot or the weapon officer, crew, or gunner with the capability to electrically arm/safe each respective weapon from the cockpit, crew station, or operator station as appropriate.
		PYRO-02	Provide the "safe/arm" status as an external cue discernible from a distance of 10-20 feet.
		PYRO-09	Provide a numerical maintenance code on maintenance panels or maintenance recorder/memory systems to denote the "safe/arm" status for each weapon or store.
		PYRO-10	Ammo loader interface should not be less than 30" nor more than 50" above the ground to ensure loading can be accomplished by a wide range of percentiles wearing chemical or biological protective gear.
		PYRO-25	Gun loading and servicing should be possible concurrently with all other weapon loading and servicing activities to minimize the elapsed downtime.
		PYRO-26	Do not locate ammunition loader interfaces close to inlets, exhausts, fuel dumps and drains, antennas, sensors, lights, or hazardous protrusions.
		PYRO-27	Incorporate integral hoisting provisions at each weapon/store station to enable direct lift from the container or carrier to the attachment hardpoints.

Guidelines by Category (Cont'd)

Category No.	Category Title	Guideline No.	Guideline
3.15	Man-Machine Interfaces	SE-01	<p>Wheel chocks for all types of ground and airborne vehicles should contain the following features:</p> <ul style="list-style-type: none"> - Be nestable for low volume during storage or transport - Be manufactured from corrosion-resistant materials - Be releasable from tire pinch - Be highly visible for day and night operations - Be impervious to all types of fluids used to service or maintain the vehicles - Be of light weight <p>Wheel chocks for airborne vehicles should also contain the following features:</p> <ul style="list-style-type: none"> - Contain provisions for securing to ramp or flight decks - Contain provisions to secure chocks at wheels - Releasable/removable from outside of hot brake envelope - Contain provisions to enable chock to be used as a tire blowout device - Contain provisions to prevent skidding on snow or ice <p>Wheel chock design guideline discussion. Wheel chocks have historically contributed to numerous accidents and incidents across the entire design spectrum, yet have received the least design attention of any ground handling/support equipment. Directly and indirectly, poorly designed chocks have:</p> <ul style="list-style-type: none"> - Resulted in numerous "jumping the chocks" incidents due to improper use or positioning, and improper chock sizing for the tire size/power application. Some instances result in destruction of the aircraft. - Resulted in vehicle movement/sliding across wet, snowy and icy surfaces as a result of improper grip. - Resulted in unwarranted tire damage and/or engine FOD. - Resulted in tertiary damage to other vehicles or ground equipment as a result of being blown about by jet/propeller blast. <ul style="list-style-type: none"> - Damaged surfaces due to temporary placement of chocks on vehicle surfaces during vehicle movement. - Resulted in personnel sliver/s abrasions (wooden chocks) and cuts (metal chocks) even when chocks were in decent useable condition. - Resulted in varied personnel ground accidents during attempts to use chocks as a temporary work stand. <p>Parts and assemblies of a given model product or of models of a product in the same series should be interchangeable or replaceable.</p> <p>Speed brake or speed brake cavity should contain integral mechanical locking mechanism for personnel safety.</p> <p>Locate Input/Output (I/O) test points and associated readouts in close proximity to each other so that one person can perform testing.</p> <p>Protect test points against the environment and from induced contamination.</p> <p>Protect test points from outside signal generation.</p> <p>Locate compartment electrical penetrations close to the access opening for ease of sight, probing, repair, and to eliminate fluid soaking, wicking, or contamination.</p> <p>Locate compartment electrical penetrations far enough from the access opening to prevent damage resulting from improper (over-length) panel fasteners.</p> <p>During design of the BIT, use worst-case stress analysis to ensure that any circuit failures induced by temperature extremes, tolerance build-up, power supply variations, and combinations thereof are identified.</p> <p>Ensure that BIT system thresholds are consistent with those across the system, subsystem, item, module, and piece-part levels to prevent excessive numbers of Cannot Duplicate (CND) and Retest OK (RTOK) events from occurring.</p> <p>The degree of BIT required or proposed should be based on the respective failure rates and the appropriate FMECA at all equipment indenture levels.</p> <p>Limit the amount of data that is recorded to a manageable size by:</p> <ul style="list-style-type: none"> - Limiting the number of signals that are monitored - Limiting the maximum sampling rate - Reducing the time span over which data is accumulated - Restricting the type of data accumulated
		SE-02	
		SE-03	
		SI-03	
		SIMP-03	
		TP-01	
		TP-02	
		TP-03	
		A-11	
3.15.01	Displays and Instrumentation	A-12	
		BIT-01	
		BIT-02	
		BIT-03	
		BIT-04	

Guidelines by Category (Cont'd)

Category No.	Category Title	Guideline No.	Guideline
3.15.01	Displays and Instrumentation		
		BIT-05	Incorporate testability design features as an integral part of equipment preliminary design process.
		BIT-06	Mission critical functions should be monitored by BIT.
		BIT-09	Use concurrent BIT to monitor system critical functions.
		BIT-16	Critical voltages should be visually monitored by sending the voltage signals to visible LEDs.
		BIT-20	The BIT should be mechanized so that when a piece of equipment is not installed in a subsystem or the product, a failure will not be indicated.
		BIT-26	Locate routinely used test points so they are accessible without removing or disassembling other equipment
		CC-01	Use fiber-optic technologies in preference to conventional interconnect concepts to reduce the number of interconnects/interfaces, reduce manufacturing and ownership costs, and significantly improve R&M.
		CC-02	Standardize connector and wire types to improve testability and logistic support. Keep the number of "different" standard connectors to a minimum. Use the same connector type keyed differently where possible.
		CC-03	Provide clearance around connectors for engagement/disengagement of cables and proper connector orientation under anticipated environmental conditions (e.g., bare hand of 50 percentile male in an enclosed or protected environment and a gloved hand of a 50 percentile male in an open or unprotected environment).
		CC-04	Use quick release cables and locate cables to make removal and replacement easy and to avoid having to remove one cable to gain access to another. Provide adequate space for cables, including sleeving and tie-downs, and adequate service loops for ease of assembly/disassembly
		CC-05	Orient and space connectors to allow a sufficient grip on the connector for cable or wire extraction without fear of using the wiring or cable for additional leverage.
		CC-06	Label, and where possible color code, each wire in a harness or cable to facilitate tracking from origin to termination. Each wire, cable, and coax-to-connector interface should be provided with a source of identification to aid in trouble shooting, repair, or modification. Marking the cable designer on the cable along with bar codes is also recommended.
		CC-07	Do not manufacture or dress connectors containing more than 25 wires or cables as a single integrated harness. Group the wires or cables into runs of no more than 25 wires or cables each. In addition to making trouble shooting and repair easier, this approach help avoid large bend radii, thereby simplifying routing, packaging, and stowage.
		CC-08	Standardize connector pin assignments for power, ground, and other frequently used signals.
		CC-09	Locate LRU/subsystem critical nodes (and or test points) so they are accessible from a connector to prevent the need for internal LRU probing or access.
		CC-10	Avoid hidden cables. Visually inspecting and tracing all assembly cables rather than having hidden cables (such as behind other cables or even LRUs) allows for a quick system and cable integrity check which aids in overall system integrity and debug. This also implies quick access for manipulative actions.
		CC-11	Orient spare wires and cable pigtails along the outer diameter or periphery of connectors to make access easier.
		CC-12	Build up and assemble straight and angle connector shells or back shells in a manner that ensures that wire or cable strain or wear is not possible.
		CO-01	Design automated systems and programs with provisions to enable "stop test" and "resume" without the need to cycle back or repeat the entire test.
		CO-02	In the event of program loss or hang-up, automated systems and programs should have provisions for reverting to manual test and operation.
		CO-03	Use a test connector to provide test and maintenance bus access to all system and subsystem faults.
		CO-04	Design systems and subsystems so that ATE can be used to access, read, and control internal components in concert with the test or checkout program.
		CO-05	Avoid the need for costly adapters for signal communications between system, subsystems, line replaceable units (LRUs) or Weapon Replaceable Assemblies (WRAs), and ATE.
		CREW-06	Film magazines, tapes, and removable modules should permit considerable handling without reliance on special support equipment protection.
		CREW-07	Electronic and photosensitive storage media should withstand the adverse environment created by ground, flightline, or shipboard electromagnetic fields and light sources.

Guidelines by Category (Cont'd)

Category No.	Category Title	Guideline No.	Guideline
3.15.01	Displays and Instrumentation		
		CREW-08	Data storage media containers and modules should be capable of chemical and biological decontamination processes.
		CREW-09	Crew and operator station cassettes or magazines should be capable of being removed and installed with one hand while the operator or air crew is seated and strapped in.
		CREW-10	Design cameras, recorders, and sensors to be fully interchangeable and quickly replaceable.
		ECS-01	Design so that equipment servicing status are accessible and readable from the ground level for air vehicles and from the operator's position for ground and water vehicles.
		EG-01	Design feedback loops so that the loop can be broken during test to ensure that faults do not propagate to the point where they cannot be isolated.
		EG-02	Avoid using external feedback loops requiring complex circuitry to simulate feedback I/Os.
		EG-03	In rare instances when complex external feedback loops cannot be avoided, incorporate simple interruptible control points.
		EG-04	Avoid long sequences of vectors to initialize or alter device outputs to minimize potential testability problems.
		EG-05	Avoid the need to have test equipment generate complex, phased or time related signals.
		EG-06	Test points should be located on all circuit nodes that are useful in determining the module's health.
		EG-07	Test points should be designed so that functional circuitry cannot be damaged or degraded due to the routing or accidental shorting of a signal at a test point. Some type of test point isolation technique should be used (buffers, isolator, etc.).
		EG-08	Test points should be easily accessed and clearly marked.
		EG-10	Design redundant circuits to be independently testable to ensure errors are not masked.
		EG-11	To improve the probability of fault detection, avoid shorting signals together to achieve a specific test function or condition.
		EG-12	Incorporate concept for partitioning module functions to simplify test equipment or eliminate the need for ancillary test equipment..
		EG-13	Design oscillators or clocks that are resident on the module to be replaceable by a signal from a connector to avoid the need to synchronize ATE to on-board signals.
		FI-01	Design each FI test to be independent of all other tests.
		FI-02	Design FI initiation to be subordinate to the higher priority predecessor tests.
		FI-03	Design each test so that it can be terminated prior to completion and then re-initiated at its start point.
		FI-04	Design the unit tests so that they can accommodate the following subsystem response modes: <ul style="list-style-type: none"> - Incorrect response - No response - Inconsistent response - Unexpected condition
		FI-05	Design all software so that it is structured by test priority. The test software should take advantage of both subroutine constructs for all message outputs and of failure dictionaries which identify the location of the most likely failed replaceable unit.
		FI-06	In an airborne avionics system, consider indicating mission critical faults on a pilots "head-up" display accompanied with an audible alarm, so that the pilot can easily check for critical system or mission threatening problems.
		FI-07	Ensure that system user manuals include instructions for faults not covered by BIT such as, system will not power up or system is being used in an incorrect environment such as, at the wrong altitude, etc.
		FI-08	Interlock the high power sections of systems and subsystems with visual/audible BIT to ensure safe system activation.
		FI-09	Design BIT to first conduct self-test for circuitry integrity before conducting system test.
		FI-10	Use clear text to report failures rather than alpha-numeric codes, lights, indicators, etc.
		FI-11	Locate BIT circuitry on the same level of the subsystem under test to simplify test and repair when it is removed from the main system.
		MC-02	Avoid the use of cotter pins, safety wire, safety clips, and similar devices to prevent maintenance-induced events leading to ground vehicle accidents or loss of air vehicles.

Guidelines by Category (Cont'd)

Category No.	Category Title	Guideline No.	Guideline
3.15.01	Displays and Instrumentation	MC-06	Locate, position, orient all plumbing and duct electrical connectors to prevent the need for sequential installation or removal.
		MC-12	All plumbing and connectors containing liquids should be meniscus-free.
		MG-03	Clearly mark all subsystems/LRUs to make system integration, test, debug, and repair easier.
		MP-01	Avoid the use of epoxies to mount parts on repairable modules because they make repair extremely difficult.
		MP-02	Use a unique identification (ID) resistor incorporated in each system module to verify that the proper module is mounted on ATE.
		MP-03	Design modules so that lengthy warm-up times, special coding and air purity levels, and similar constraints are not necessary.
		SI-03	Parts and assemblies of a given model product or of models of a product in the same series should be interchangeable or replaceable.
		SIMP-01	Location and design of all exterior lights should not require protective covers in ground environments.
		TP-01	Locate Input/Output (I/O) test points and associated readouts in close proximity to each other so that one person can perform testing.
		TP-02	Protect test points against the environment and from induced contamination.
		TP-03	Protect test points from outside signal generation.
3.15.02	Service, Caution, Warning, and Advisory Lights and Indicators	BIT-01	During design of the BIT, use worst-case stress analysis to ensure that any circuit failures induced by temperature extremes, tolerance build-up, power supply variations, and combinations thereof are identified.
		BIT-02	Ensure that BIT system thresholds are consistent with those across the system, subsystem, item, module, and piece-part levels to prevent excessive numbers of Cannot Duplicate (CND) and Retest OK (RTOK) events from occurring.
		BIT-03	The degree of BIT required or proposed should be based on the respective failure rates and the appropriate FMECA at all equipment indenture levels.
		BIT-04	Limit the amount of data that is recorded to a manageable size by: <ul style="list-style-type: none"> - Limiting the number of signals that are monitored - Limiting the maximum sampling rate - Reducing the time span over which data is accumulated - Restricting the type of data accumulated
		BIT-05	Incorporate testability design features as an integral part of equipment preliminary design process.
		BIT-06	Mission critical functions should be monitored by BIT.
		BIT-09	Use concurrent BIT to monitor system critical functions.
		BIT-16	Critical voltages should be visually monitored by sending the voltage signals to visible LEDs.
		BIT-17	BIT failures should be latched on the module. This makes it easier for the system or ATE to poll the error bit at any time.
		BIT-18	If many BIT routines exist on a module, then ATE should have access and the ability to control each routine individually.
		BIT-19	Design BIT to have a very low false alarm rate; otherwise BIT will not be an effective maintenance tool. As a goal, the false alarm rate should be 1% or less.
		BIT-20	The BIT should be mechanized so that when a piece of equipment is not installed in a subsystem or the product, a failure will not be indicated.
		BIT-26	Locate routinely used test points so they are accessible without removing or disassembling other equipment
		CC-01	Use fiber-optic technologies in preference to conventional interconnect concepts to reduce the number of interconnects/interfaces, reduce manufacturing and ownership costs, and significantly improve R&M.
		CC-02	Standardize connector and wire types to improve testability and logistic support. Keep the number of "different" standard connectors to a minimum. Use the same connector type keyed differently where possible.
		CC-03	Provide clearance around connectors for engagement/disengagement of cables and proper connector orientation under anticipated environmental conditions (e.g., bare hand of 50 percentile male in an enclosed or protected environment and a gloved hand of a 50 percentile male in an open or unprotected environment).

Guidelines by Category (Cont'd)

Category No.	Category Title	Guideline No.	Guideline
3.15.02	Service, Caution, Warning, and Advisory Lights and Indicators	CC-04	Use quick release cables and locate cables to make removal and replacement easy and to avoid having to remove one cable to gain access to another. Provide adequate space for cables, including sleeving and tie-downs, and adequate service loops for ease of assembly/disassembly
		CC-05	Orient and space connectors to allow a sufficient grip on the connector for cable or wire extraction without fear of using the wiring or cable for additional leverage.
		CC-06	Label, and where possible color code, each wire in a harness or cable to facilitate tracking from origin to termination. Each wire, cable, and coax-to-connector interface should be provided with a source of identification to aid in trouble shooting, repair, or modification. Marking the cable designer on the cable along with bar codes is also recommended.
		CC-07	Do not manufacture or dress connectors containing more than 25 wires or cables as a single integrated harness. Group the wires or cables into runs of no more than 25 wires or cables each. In addition to making trouble shooting and repair easier, this approach help avoid large bend radii, thereby simplifying routing, packaging, and stowage.
		CC-08	Standardize connector pin assignments for power, ground, and other frequently used signals.
		CC-09	Locate LRU/subsystem critical nodes (and or test points) so they are accessible from a connector to prevent the need for internal LRU probing or access.
		CC-10	Avoid hidden cables. Visually inspecting and tracing all assembly cables rather than having hidden cables (such as behind other cables or even LRUs) allows for a quick system and cable integrity check which aids in overall system integrity and debug. This also implies quick access for manipulative actions.
		CC-11	Orient spare wires and cable pigtails along the outer diameter or periphery of connectors to make access easier.
		CC-12	Build up and assemble straight and angle connector shells or back shells in a manner that ensures that wire or cable strain or wear is not possible.
		CO-03	Use a test connector to provide test and maintenance bus access to all system and subsystem faults.
		CO-05	Avoid the need for costly adapters for signal communications between system, subsystems, line replaceable units (LRUs) or Weapon Replaceable Assemblies (WRAs), and ATE.
		ECS-01	Design so that equipment servicing status are accessible and readable from the ground level for air vehicles and from the operator's position for ground and water vehicles.
		ENG-01	All facets of engine design should take advantage of Electrostatic Engine Monitoring Systems (EEMS) and Inductive Debris Monitoring (IDM) toward achievement of on-condition maintenance and engine health monitoring.
		ENG-02	Each different component of rotating machinery should contain different tracer elements to enhance EEMS and IDM isolation and tracking of wear.
		ENG-03	Digital electronic controls, fully automatic digital electronic controls, and similar concepts should contain the highest degree of BIT and diagnostics commensurate with affordability, operation and maintenance, and life cycle costs as appropriate.
		FI-01	Design each FI test to be independent of all other tests.
		FI-02	Design FI initiation to be subordinate to the higher priority predecessor tests.
		FI-03	Design each test so that it can be terminated prior to completion and then re-initiated at its start point.
		FI-04	Design the unit tests so that they can accommodate the following subsystem response modes: <ul style="list-style-type: none"> - Incorrect response - No response - Inconsistent response - Unexpected condition
		FI-05	Design all software so that it is structured by test priority. The test software should take advantage of both subroutine constructs for all message outputs and of failure dictionaries which identify the location of the most likely failed replaceable unit.
		FI-06	In an airborne avionics system, consider indicating mission critical faults on a pilots "head-up" display accompanied with an audible alarm, so that the pilot can easily check for critical system or mission threatening problems.
		FI-07	Ensure that system user manuals include instructions for faults not covered by BIT such as, system will not power up or system is being used in an incorrect environment such as, at the wrong altitude, etc.

Guidelines by Category (Cont'd)

Category No.	Category Title	Guideline No.	Guideline
3.15.02	Service, Caution, Warning, and Advisory Lights and Indicators	FI-08	Interlock the high power sections of systems and subsystems with visual/audible BIT to ensure safe system activation.
		FI-09	Design BIT to first conduct self-test for circuitry integrity before conducting system test.
		FI-10	Use clear text to report failures rather than alpha-numeric codes, lights, indicators, etc.
		FI-11	Locate BIT circuitry on the same level of the subsystem under test to simplify test and repair when it is removed from the main system.
		MC-06	Locate, position, orient all plumbing and duct electrical connectors to prevent the need for sequential installation or removal.
		MG-03	Clearly mark all subsystems/LRUs to make system integration, test, debug, and repair easier.
		MP-01	Avoid the use of epoxies to mount parts on repairable modules because they make repair extremely difficult.
		MP-02	Use a unique identification (ID) resistor incorporated in each system module to verify that the proper module is mounted on ATE.
		MP-03	Design modules so that lengthy warm-up times, special coding and air purity levels, and similar constraints are not necessary.
		PYRO-09	Provide positive, Murphy-proof locking detents for both the "safe" and "arm" positions of mechanical mechanisms.
		PYRO-10	Provide a numerical maintenance code on maintenance panels or maintenance recorder/memory systems to denote the "safe/arm" status for each weapon or store.
		SI-03	Parts and assemblies of a given model product or of models of a product in the same series should be interchangeable or replaceable.
		SIMP-01	Location and design of all exterior lights should not require protective covers in ground environments.
		SIMP-02	Landing and taxi lights should be mounted on landing gear struts or doors to eliminate separate compartments, doors, and retraction/extension mechanisms.
		TP-01	Locate Input/Output (I/O) test points and associated readouts in close proximity to each other so that one person can perform testing.
		TP-02	Protect test points against the environment and from induced contamination.
		TP-03	Protect test points from outside signal generation.
		BIT-01	During design of the BIT, use worst-case stress analysis to ensure that any circuit failures induced by temperature extremes, tolerance build-up, power supply variations, and combinations thereof are identified.
		BIT-02	Ensure that BIT system thresholds are consistent with those across the system, subsystem, item, module, and piece-part levels to prevent excessive numbers of Cannot Duplicate (CND) and Retest OK (RTOK) events from occurring.
		BIT-03	The degree of BIT required or proposed should be based on the respective failure rates and the appropriate FMECA at all equipment indented levels.
		BIT-04	Limit the amount of data that is recorded to a manageable size by: <ul style="list-style-type: none"> - Limiting the number of signals that are monitored - Limiting the maximum sampling rate - Reducing the time span over which data is accumulated - Restricting the type of data accumulated
		BIT-05	Incorporate testability design features as an integral part of equipment preliminary design process.
		BIT-06	Mission critical functions should be monitored by BIT.
		BIT-07	Set BIT tolerances to maximize fault detection and minimize false alarm rate in the expected operating environment.
		BIT-08	Design BIT fault detectors to accommodate the needs of operator maintenance personnel.
		BIT-09	Use concurrent BIT to monitor system critical functions.
		BIT-10	Design the BIT and BITE so that no fault or failure within the BIT or BITE will degrade, disrupt, or fail the system being monitored.
		BIT-11	In the area of software design and test responsibility, the responsibility for the design and development of verification testing of an end item (e.g., digital filter) should reside with the same engineer(s).
3.15.03	Data Entry		

Guidelines by Category (Cont'd)

Category No.	Category Title	Guideline No.	Guideline
3.15.03	Data Entry	BIT-12	Define stimuli and response data for each diagnostic test at the system/subsystem level. The same data should be planned for use both in factory testing as well as in field maintenance of the equipment. These data minimize the amount of unique software to be written.
		BIT-13	Provide for manual control to test sequences, so that the test can be selected individually, and appropriate test combinations can be executed at the operator's discretion.
		BIT-14	Provide access to all BIT control and status signals at module connector pins. This will enable ATE to directly connect to BIT circuitry.
		BIT-15	Incorporate complete BIT functions and BITE on module. If only a portion of the BIT routine or BITE circuitry exists on the module, then ATE cannot utilize the BIT routine without providing the missing BIT functions.
		BIT-16	Critical voltages should be visually monitored by sending the voltage signals to visible LEDs.
		BIT-20	The BIT should be mechanized so that when a piece of equipment is not installed in a subsystem or the product, a failure will not be indicated.
		BIT-26	Locate routinely used test points so they are accessible without removing or disassembling other equipment
		CC-01	Use fiber-optic technologies in preference to conventional interconnect concepts to reduce the number of interconnects/interfaces, reduce manufacturing and ownership costs, and significantly improve R&M.
		CC-02	Standardize connector and wire types to improve testability and logistic support. Keep the number of "different" standard connectors to a minimum. Use the same connector type keyed differently where possible.
		CC-03	Provide clearance around connectors for engagement/disengagement of cables and proper connector orientation under anticipated environmental conditions (e.g., bare hand of 50 percentile male in an enclosed or protected environment and a gloved hand of a 50 percentile male in an open or unprotected environment).
		CC-04	Use quick release cables and locate cables to make removal and replacement easy and to avoid having to remove one cable to gain access to another. Provide adequate space for cables, including sleeving and tie-downs, and adequate service loops for ease of assembly/disassembly
		CC-05	Orient and space connectors to allow a sufficient grip on the connector for cable or wire extraction without fear of using the wiring or cable for additional leverage.
		CC-06	Label, and where possible color code, each wire in a harness or cable to facilitate tracking from origin to termination. Each wire, cable, and coax-to-connector interface should be provided with a source of identification to aid in trouble shooting, repair, or modification. Marking the cable designer on the cable along with bar codes is also recommended.
		CC-07	Do not manufacture or dress connectors containing more than 25 wires or cables as a single integrated harness. Group the wires or cables into runs of no more than 25 wires or cables each. In addition to making trouble shooting and repair easier, this approach help avoid large bend radii, thereby simplifying routing, packaging, and stowage.
		CC-08	Standardize connector pin assignments for power, ground, and other frequently used signals.
		CC-09	Locate LRU/subsystem critical nodes (and or test points) so they are accessible from a connector to prevent the need for internal LRU probing or access.
		CC-10	Avoid hidden cables. Visually inspecting and tracing all assembly cables rather than having hidden cables (such as behind other cables or even LRUs) allows for a quick system and cable integrity check which aids in overall system integrity and debug. This also implies quick access for manipulative actions.
		CC-11	Orient spare wires and cable pigtails along the outer diameter or periphery of connectors to make access easier.
		CC-12	Build up and assemble straight and angle connector shells or back shells in a manner that ensures that wire or cable strain or wear is not possible.
		CO-01	Design automated systems and programs with provisions to enable "stop test" and "resume" without the need to cycle back or repeat the entire test.
		CO-02	In the event of program loss or hang-up, automated systems and programs should have provisions for reverting to manual test and operation.
		CO-03	Use a test connector to provide test and maintenance bus access to all system and subsystem faults.
		CO-04	Design systems and subsystems so that ATE can be used to access, read, and control internal components in concert with the test or checkout program.

Guidelines by Category (Cont'd)

Category No.	Category Title	Guideline No.	Guideline
3.15.03	Data Entry	CO-05	Avoid the need for costly adapters for signal communications between system, subsystems, line replaceable units (LRUs) or Weapon Replaceable Assemblies (WRAs), and ATE.
		FI-01	Design each FI test to be independent of all other tests.
		FI-02	Design FI initiation to be subordinate to the higher priority predecessor tests.
		FI-03	Design each test so that it can be terminated prior to completion and then re-initiated at its start point.
		FI-04	Design the unit tests so that they can accommodate the following subsystem response modes: - Incorrect response - No response - Inconsistent response - Unexpected condition
		FI-05	Design all software so that it is structured by test priority. The test software should take advantage of both subroutine constructs for all message outputs and of failure dictionaries which identify the location of the most likely failed replaceable unit.
		FI-06	In an airborne avionics system, consider indicating mission critical faults on a pilots "head-up" display accompanied with an audible alarm, so that the pilot can easily check for critical system or mission threatening problems.
		FI-07	Ensure that system user manuals include instructions for faults not covered by BIT such as, system will not power up or system is being used in an incorrect environment such as, at the wrong altitude, etc.
		FI-08	Interlock the high power sections of systems and subsystems with visual/audible BIT to ensure safe system activation.
		FI-09	Design BIT to first conduct self-test for circuitry integrity before conducting system test.
		FI-10	Use clear text to report failures rather than alpha-numeric codes, lights, indicators, etc.
		FI-11	Locate BIT circuitry on the same level of the subsystem under test to simplify test and repair when it is removed from the main system.
		MG-03	Clearly mark all subsystems/LRUs to make system integration, test, debug, and repair easier.
		MP-01	Avoid the use of epoxies to mount parts on repairable modules because they make repair extremely difficult.
		MP-02	Use a unique identification (ID) resistor incorporated in each system module to verify that the proper module is mounted on ATE.
		MP-03	Design modules so that lengthy warm-up times, special coding and air purity levels, and similar constraints are not necessary.
		TP-01	Locate Input/Output (I/O) test points and associated readouts in close proximity to each other so that one person can perform testing.
		TP-02	Protect test points against the environment and from induced contamination.
		TP-03	Protect test points from outside signal generation.
		A-06	Hardpoints (structural attachment and load bearing areas) within a compartment to assist in equipment mounting or support should not be integral with the machined part. Hardpoints should be parasitic to enable quick repair in case of wear or damage in lieu of precise ream/bush repair typical of machined hardpoints.
		BIT-01	During design of the BIT, use worst-case stress analysis to ensure that any circuit failures induced by temperature extremes, tolerance build-up, power supply variations, and combinations thereof are identified.
		BIT-02	Ensure that BIT system thresholds are consistent with those across the system, subsystem, item, module, and piece-part levels to prevent excessive numbers of Cannot Duplicate (CND) and Retest OK (RTOK) events from occurring.
		BIT-03	The degree of BIT required or proposed should be based on the respective failure rates and the appropriate FMECA at all equipment indeture levels.
		BIT-04	Limit the amount of data that is recorded to a manageable size by: - Limiting the number of signals that are monitored - Limiting the maximum sampling rate - Reducing the time span over which data is accumulated - Restricting the type of data accumulated
3.15.04	Controls		

Guidelines by Category (Cont'd)

Category No.	Category Title	Guideline No.	Guideline
3.15.04	Controls		
		BIT-05	Incorporate testability design features as an integral part of equipment preliminary design process.
		BIT-06	Mission critical functions should be monitored by BIT.
		BIT-09	Use concurrent BIT to monitor system critical functions.
		BIT-16	Critical voltages should be visually monitored by sending the voltage signals to visible LEDs.
		BIT-20	The BIT should be mechanized so that when a piece of equipment is not installed in a subsystem or the product, a failure will not be indicated.
		BIT-26	Locate routinely used test points so they are accessible without removing or disassembling other equipment
		CC-03	Provide clearance around connectors for engagement/disengagement of cables and proper connector orientation under anticipated environmental conditions (e.g., bare hand of 50 percentile male in an enclosed or protected environment and a gloved hand of a 50 percentile male in an open or unprotected environment).
		CC-05	Orient and space connectors to allow a sufficient grip on the connector for cable or wire extraction without fear of using the wiring or cable for additional leverage.
		CO-01	Design automated systems and programs with provisions to enable "stop test" and "resume" without the need to cycle back or repeat the entire test.
		CO-02	In the event of program loss or hang-up, automated systems and programs should have provisions for reverting to manual test and operation.
		CO-03	Use a test connector to provide test and maintenance bus access to all system and subsystem faults.
		CO-04	Design systems and subsystems so that ATE can be used to access, read, and control internal components in concert with the test or checkout program.
		CO-05	Avoid the need for costly adapters for signal communications between system, subsystems, line replaceable units (LRUs) or Weapon Replaceable Assemblies (WRAs), and ATE.
		CONT-01	Control rods should use Boyd or impedance type bolts (or equivalent) to eliminate the need for cotter pins or safety wire.
		CONT-02	Do not use metal control cables for vehicles that will operate in salt water or salt air environments.
		CONT-03	Use control rods rather than control cables for non-complex applications and non-complex routing within the vehicle.
		CONT-04	Use control cables rather than control rods for most complex applications.
		CONT-05	Route cables so that 100 percent of a cable will be viewable for inspection.
		CONT-06	Design all pulleys and brackets associated with cable installations so they are accessible by a 75 percentile male hand.
		CREW-04	Avoid wiring, coax, and plumbing penetrations through the floor of crew cabs, operators' compartments, crew stations, cockpits, and passenger compartments.
		CREW-05	Structural instrument panels, dashboards, and control panels should be modularized for easy and adequate access to all interfaces, to simplify manufacturing, and to reduce maintenance-induced problems.
		ENV-01	Materials, treatments, coatings, finishes should be compatible with all anti-ice and de-ice fluids, chemical and biological decontamination fluids, washing and cleaning fluids, and all vehicle subsystem fluids.
		ENV-02	There should be no top coat or treatment deterioration throughout the standard temperature and humidity spectrum.
		ENV-03	For airborne vehicles, the finishes should be durable against rain, hail, and dynamic erosion throughout the flight envelope.
		ENV-04	For airborne and ground vehicles, the finishes should be durable against sand erosion throughout all surface wind speeds experienced in arid or desert geographical locations.
		ENV-06	For ground vehicles, the finishes should be compatible with and durable against all rain, hail, sleet, snow, and ice conditions experienced in all intended operational environments.
		ENV-07	The finishes and surfaces should be capable of low velocity impact (LVI) of 10 foot-pounds with no visual or detectable damage with a design goal of 30 foot-pounds.
		MC-06	Locate, position, orient all plumbing and duct electrical connectors to prevent the need for sequential installation or removal.
		MC-09	All plumbing connections and fittings used for fuel systems should contain integral bonding features to eliminate the need for bonding clamps or jumper cables.

Guidelines by Category (Cont'd)

Category No.	Category Title	Guideline No.	Guideline
3.15.04	Controls	MC-10	In rare instances where a plumbing run contains complex form or geometry that would require removal of other plumbing or equipment for access, in-line connectors should be incorporated to maintain the integrity of other plumbing or equipment.
		MG-03	Clearly mark all subsystems/LRUs to make system integration, test, debug, and repair easier.
		MP-01	Avoid the use of epoxies to mount parts on repairable modules because they make repair extremely difficult.
		MP-02	Use a unique identification (ID) resistor incorporated in each system module to verify that the proper module is mounted on ATE.
		MP-03	Design modules so that lengthy warm-up times, special coding and air purity levels, and similar constraints are not necessary.
		SI-01	Leading edges containing complex integrated antennas or sensors should be interchangeable to enhance repair of battle damage and induced damage.
		SI-02	Speed brake hinge and actuator attachment hardpoints should enable interchangeability of speed brake(s) and actuator(s) without need for rigging.
		SI-03	Parts and assemblies of a given model product or of models of a product in the same series should be interchangeable or replaceable.
		TP-01	Locate Input/Output (I/O) test points and associated readouts in close proximity to each other so that one person can perform testing.
		TP-02	Protect test points against the environment and from induced contamination.
		TP-03	Protect test points from outside signal generation.
		A-01	Seal equipment bays and compartments against the environmental elements including all types of servicing fluids used for the vehicle, all types of anti-ice and de-ice fluids, and all types of fluids used for chemical, biological, or nuclear decontamination
		A-02	Equipment bay and compartment structure should be bonded, co-cured, welded, machined, or combinations thereof to eliminate or minimize the use of mechanical fasteners.
		A-03	All equipment bay and compartment structural flanges and stiffeners should be external to the compartment to maximize the volume available for equipment installation and arrangement.
		A-14	Do not locate nuplates or gang channels in inaccessible areas that would require extensive disassembly or equipment removal to gain access.
		A-15	Locate tie-down attachment points such that tie-down chains, straps, or cables do not prevent or restrict normal servicing, weapon loading, or safe/arm functions.
		A-16	Structural design should provide good access to corrosion-prone areas for inspection and treatment.
		A-17	All structural fasteners in an access door or panel should be of identical grip and diameter. In rare cases where this is not possible, fasteners of different grip must have different diameters to prevent a shorter fastener being substituted for the correct, longer fastener.
		A-18	Use transparent windows, quick-opening covers, or openings without any cover to permit quick visual inspections where needed.
		BIT-06	Mission critical functions should be monitored by BIT.
		BIT-09	Use concurrent BIT to monitor system critical functions.
		CREW-04	Avoid wiring, coax, and plumbing penetrations through the floor of crew cabs, operators' compartments, crew stations, cockpits, and passenger compartments.
		CREW-05	Structural instrument panels, dashboards, and control panels should be modularized for easy and adequate access to all interfaces, to simplify manufacturing, and to reduce maintenance-induced problems.
		D&V-01	The geometric aspects of structural design and interfaces should not result in any natural bathtubs.
		D&V-02	Closed structural sections subject to condensation or fluid migration should contain drainage provisions.
		D&V-03	Crew cabs, operators' compartments, crew stations, cockpits, and passenger compartments should be subject to the same corrosion prevention measures as the exteriors of the vehicles. Low points, pockets, and related fluid collection points within should be provided with low point drains.
3.15.05	Access		

MIL-HDBK-470A

APPENDIX C

Guidelines by Category (Cont'd)

Category No.	Category Title	Guideline No.	Guideline
3.15.05	Access		
		EC-08	Locate and position electrical connectors such that all pin identification for either half can be easily seen.
		ENG(G)-01	Provide access to all engine mounts for ground vehicles so that hoisting or crawling under the vehicle is not required.
		ENG(G)-02	Use torque-limiting bolts or torque washers as engine mount attaching hardware to eliminate the need for torque wrenches.
		ENG(G)-04	Do not use downward engine removal concepts that require jacking or hoisting of the ground vehicle.
		ENG(G)-05	Use concepts for removing ground vehicle engines from the front, rear, or side rather than from overhead (using hoisting).
		ENG(G)-06	The distance between the engine and firewall should ensure the access envelopes to lines, fittings, wiring, and adjustments will accommodate the 75 percentile male hand.
		ENG(G)-07	The distance between the cooling fan and radiator core should ensure that access envelopes will not require removal of the core.
		ENG(G)-09	Design all interfaces between the engine assembly and the host vehicle to be in full view of the maintainers and so that crawling under the vehicle is not required.
		ENG-12	All engine-mounted accessories must be capable of being removed and installed through the available airframe access openings.
		ENG-15	Engine removal for aircraft intended to be operated off carriers should be accomplished within the shadow of the aircraft.
		ENG-16	Aircraft jacking should not be required for engine removal.
		ENG-17	Aft engine removal should be an acceptable alternative for USAF aircraft.
		ENG-18	For either downward or aft engine removal, it should be possible to maintain control of the engine on all axis during the entire removal and installation process.
		ENG-20	Do not locate equipment or components in the engine cavity except for those components associated with the engine or engine installation.
		ENG-21	Do not locate equipment or components in the engine bay cavity in a manner that would require removal or repositioning for engine removal.
		ENV-06	For ground vehicles, the finishes should be compatible with and durable against all rain, hail, sleet, snow, and ice conditions experienced in all intended operational environments.
		ENV-07	The finishes and surfaces should be capable of low velocity impact (LVI) of 10 foot-pounds with no visual or detectable damage with a design goal of 30 foot-pounds.
		EXT-01	Locate Tanks, Pods, Containers, and Devices (TPCD's) so they do not block or restrict access to existing vehicle access areas or access approach envelopes.
		EXT-05	Design access doors for cargo type TPCD's to be non-load carrying and with simple latches for all doors and panels.
		F-01	Use blind fasteners only where absolutely necessary or where considerable cost can be saved.
		F-02	Minimize access fasteners while making them quick release, easily removed and replaced, and captive.
		F-03	Choose fasteners based on the requirement to operate by hand or with common hand tools rather than special tools.
		F-04	Whenever possible, incorporate barrel type fasteners as opposed to hi-torque fasteners. Failure of Hi-torque fasteners due to stripping are common and a source of potential foreign object damage (FOD).
		HF-01	Steps and handholds for all ground vehicles should be parasitic to the surface and capable of safely supporting a 95 percentile male wearing arctic boots.
		HF-03	Provide hoist fittings or hardpoints for hoist fitting attachments that are readily accessible.
		HF-04	Size structural openings into man-rated fuel cells to enable entry by a 75 percentile male.
		HF-05	In designing the vehicle, system, subsystem, and equipment, attempt to satisfy the personnel spectrum from the 5th percentile female to the 95th percentile male.
		IN(V)-02	Do not use loose structural fasteners in the access area to inlet door actuators and mechanisms. Where this guideline cannot be followed, design the actuator door to be accessible only when the inlet doors are fully closed.
		LO-01	Use LO compatible gap fillers for manufactured gaps in lieu of tape and butter (surface coating compound).

MIL-HDBK-470A

APPENDIX C

Guidelines by Category (Cont'd)

Category No.	Category Title	Guideline No.	Guideline
3.15.05	Access	MC-06	Locate, position, orient all plumbing and duct electrical connectors to prevent the need for sequential installation or removal.
		MC-15	Route, orient, and position plumbing, wiring, ducts, and connectors sufficiently away from the outer surface of the vehicle to preclude induced damage due to minor dents, drill bits during repair, etc. Minimum rule of thumb is 1" away from the inner surface and 1" below a plate nut channel.
		P-01	Access door and panel fastener types for airborne vehicles should meet the following criteria: <ul style="list-style-type: none"> - use latches for a frequency of access of 0 to 40 flight hours - use High Strength Quick Release fasteners for a frequency of access of 40-400 flight hours - use structural screws for a frequency of access of 400 flight hours or more
		P-02	Access door and panel fastener types for surface vehicles should meet the following criteria: <ul style="list-style-type: none"> - use a spring loaded or latch fastener for an opening frequency of daily - use a one quarter turn fastener (or equivalent) for a opening frequency of weekly - use screws or bolts for all other cases
		P-03	All doors and panels subject to environmental elements should contain form-in-place seals (or equivalent) attached to the door structure, not substructure, to prevent damage during maintenance.
		P-04	Door and panel seals should be compatible with all types of on-board servicing fluids, de-ice and anti-ice fluids, and all fluids used for chemical, biological, and nuclear decontamination.
		P-05	Piano type hinges should not be used on doors or panels because they are subject to wear, corrosion, and sand and fluid entry.
		P-06	Access door and panel devices used to support door in opened position should meet the following criteria: <ul style="list-style-type: none"> - for airborne vehicles, design for 60 knot gust loads (or equivalent jet blast loads) - for ground vehicles, design for 50 mph gust loads
		P-07	Hinged access doors and panels capable of remaining in the opened position should not have sharp edges or corners.
		P-08	Removable access door and panel fasteners should be of identical grip length and diameter.
		P-09	Acceptable door and panel hold-open devices include over-center sheet metal spring, over-center spring link, spring cartridge, support strut, and pinned goose neck hinge.
		P-10	Access doors and panels requiring non-captive fasteners should not be located forward of air inlet ducts or high-energy rotating components (e.g., prop fans, engine cooling fans, etc.).
		P-11	Access doors and panels should be interchangeable as justified by operation and support costs or life cycle costs.
		PYRO-31	Ensure weapon bay door open positions do not intrude into any other door opening envelope.
		PYRO-32	Provide sufficient longitudinal clearance between weapon bays to enable simultaneous loading of two bays.
		PYRO-33	Provide sufficient lateral clearance between weapon bays to enable simultaneous loading of two bays.
		SABCH-01	Do not locate auxiliary air inlets, sensors, access doors, or drains in boundary bleed areas.
		SABCH-11	In rare instances where the use of dissimilar material in immediate contact cannot be avoided, they should be sufficiently insulated to endure for the life of the vehicle.
		SABCH-12	Avoid tapping threads into structural members. Use of heli-coil type or similar insert concepts is permissible.
		SABCH-13	No structural design concept should rely on frequent scheduled inspections to monitor or otherwise ensure structural integrity.
		SABCH-14	No structural fastener intended to carry shear or tension loads should be smaller than 1/4" diameter (.25").
		SABCH-15	Give preference to butt type splices over lap type splices in the design of manufacturing splices.
		SIMP-01	Location and design of all exterior lights should not require protective covers in ground environments.
		SIMP-02	Landing and taxi lights should be mounted on landing gear struts or doors to eliminate separate compartments, doors, and retraction/extension mechanisms.
		SIMP-03	Speed brake or speed brake cavity should contain integral mechanical locking mechanism for personnel safety.
		WBAY-16	Gap seals should not degrade loading while wearing arctic or chemical, biological, or radiation protective clothing.

Guidelines by Category (Cont'd)

Category No.	Category Title	Guideline No.	Guideline
3.15.05	Access	WIND-05	Design interior surfaces to be reachable for cleaning without reliance on hinging, equipment removal, or use of support equipment.
3.16	Equipment Decontamination	A-10	Provide a sufficient number of compartment fluid drains to ensure fluid drainage for varying aircraft static attitudes and varying terrain slopes for ground vehicles.
		A-11	Locate compartment electrical penetrations close to the access opening for ease of sight, probing, repair, and to eliminate fluid soaking, wicking, or contamination.
		A-12	Locate compartment electrical penetrations far enough from the access opening to prevent damage resulting from improper (over-length) panel fasteners.
		A-13	Two-sided or two-surfaced access should not be required for access to equipment interfaces and hardpoints. The term two-sided infers top/bottom, left/right, front/back, or combinations thereof.
		A-16	Structural design should provide good access to corrosion-prone areas for inspection and treatment.
		ARM-13	Do not locate magnesium fittings or structure in the motor plume of rail-launched missiles.
		CBR-01	Orient all vehicle liquid servicing fittings to ensure fluids will not come in contact with protective garb during connect/disconnect activities.
		CBR-02	Ensure vehicle overboard passive liquid drains are clearly marked or visible to enable personnel to remain clear of area.
		CBR-03	Design fuel cell drains so they can not be activated in a manner that would allow fuel to come in contact with a protected hand.
		CREW-06	Film magazines, tapes, and removable modules should permit considerable handling without reliance on special support equipment protection.
		CREW-08	Data storage media containers and modules should be capable of chemical and biological decontamination processes.
		D&V-01	The geometric aspects of structural design and interfaces should not result in any natural bathtubs.
		D&V-02	Closed structural sections subject to condensation or fluid migration should contain drainage provisions.
		D&V-03	Crew cabs, operators' compartments, crew stations, cockpits, and passenger compartments should be subject to the same corrosion prevention measures as the exteriors of the vehicles. Low points, pockets, and related fluid collection points within should be provided with low point drains.
		EDECOM-01	Provide surface sensors on equipment located in compartments containing louvers, screens, flush inlets, or similar openings to the environment to indicate the presence of chem/bio contaminants.
		EDECOM-02	Provide integral sensors (viewable from the exterior) for equipment subject to internal forced-air cooling from outside or external air to indicate the presence of contaminants.
		EDECOM-03	Design equipment surfaces and structure to be compatible with all decontamination agents and methods.
		EDECOM-04	Provide passive overboard drains in compartments subject to decontamination processes to void the area of contaminants.
		EDECOM-05	Provide hoist, lift or transport handles for equipment requiring removal from the host vehicle for decontamination. In instances where this may not be practical, design the equipment with hardpoints for attaching parasitic carrying provisions
		ENG(G)-16	Do not locate batteries in the engine compartment. In those instances where this is not possible: - The battery support structure should be of a material that is impervious to acid leakage or boil-over. - The battery support structure should serve as a scupper to collect and direct the acid out of the engine compartment.
		ENG(G)-19	Paint engine compartments gloss white to enhance light reflectivity and enhance fluid leak detection.
		ENG-06	All other engine surfaces and engine-mounted accessory surfaces should be free of pockets, channels, and bathtubs that could trap and retain fluids.
		ENG-37	Gravity type servicing fittings, covers, and caps should have integral locking features, operable by hand, and contain a cable or chain to prevent loss or dropping.
		ENG-47	Design the engine, including all accessories, plumbing, wiring, ducts, and mechanisms, to meet the same environmental protection and compatibility requirements as the host vehicle.
		ENV-01	Materials, treatments, coatings, finishes should be compatible with all anti-ice and de-ice fluids, chemical and biological decontamination fluids, washing and cleaning fluids, and all vehicle subsystem fluids.

Guidelines by Category (Cont'd)

Category No.	Category Title	Guideline No.	Guideline
3.16	Equipment Decontamination		
		ENV-02	There should be no top coat or treatment deterioration throughout the standard temperature and humidity spectrum.
		ENV-03	For airborne vehicles, the finishes should be durable against rain, hail, and dynamic erosion throughout the flight envelope.
		ENV-04	For airborne and ground vehicles, the finishes should be durable against sand erosion throughout all surface wind speeds experienced in arid or desert geographical locations.
		ENV-05	For airborne vehicles, materials and all finishes with the engine inlet should be durable against hammer shock and compressor stalls.
		ENV-06	For ground vehicles, the finishes should be compatible with and durable against all rain, hail, sleet, snow, and ice conditions experienced in all intended operational environments.
		ENV-07	The finishes and surfaces should be capable of low velocity impact (LVI) of 10 foot-pounds with no visual or detectable damage with a design goal of 30 foot-pounds.
		IN(V)-08	Incorporate an inlet closure door sealing concept that prevents entry of fluid, dust, or sand across the entire airborne and ground environment spectrum.
		LO-01	Use LO compatible gap fillers for manufactured gaps in lieu of tape and butter (surface coating compound).
		LO-02	Avoid scheduled forced inspections or replacement of materials, coatings, or finishes solely to protect either the reliability or the signature.
		MATL-02	Cosmetic type repairs should not exceed 1 hour including cure or drying times.
		MATL-03	Cosmetic and vehicle repair material shelf life should not be less than 24 months.
		MATL-04	Cosmetic and vehicle repair materials should be non-proprietary and non-single source.
		MATL-05	Cosmetic and vehicle repair materials should not require refrigeration or special facilities or atmospheres for storage.
		MATL-06	Repair criteria, repairs, and instructions should not be classified.
		MATL-07	All cosmetic touch-up and repair materials should be environmentally safe.
		MATL-08	Repairs (other than major depot repair) should not require autoclave type facilities.
		MATL-09	A high degree of durability should be achieved across all walkway areas on the top surfaces of all vehicles up to and including 95 percentile personnel.
		MATL-10	Coatings and finishes should be durable against the effects of missile gases, velocities, and particles emanating from the missile motor.
		MATL-11	Coatings and finishes should be durable against the effects of gun gases, projectile shock waves, and brass particles emanating from the projectile seal rings.
		MATL-14	Leading edges, including chimes, containing or constructed of radar absorbing materials, should be interchangeable to reduce vehicle downtime and simplify repairs.
		MATL-15	Doors and panels containing blade seals used for signature reduction should be interchangeable or contain interchangeable blade seals. Deviation is acceptable where repairs can be accomplished on the vehicle in a time equal to or less than door or seal remove and replace time.
		MC-02	Avoid the use of cotter pins, safety wire, safety clips, and similar devices to prevent maintenance-induced events leading to ground vehicle accidents or loss of air vehicles.
		MC-03	All tubing connections and interfaces should use rosam/dynatube (or equivalent) to (1) enable connect or disconnect with one hand, one tool, (2) eliminate the need to safety the connection, (3) provide a superior seal, and (4) negate need to reposition line(s) during component replacement.
		MC-04	No trombone type, flared tube type, or piloted line type interfaces should be used to avoid the need for removal or repositioning during equipment removal.
		MC-05	Avoid potential foreign object traps during manufacturing or operational maintenance by eliminating vertical penetrations of plumbing/fittings into tanks, compartments, or cells
		MC-06	Locate, position, orient all plumbing and duct electrical connectors to prevent the need for sequential installation or removal.

Guidelines by Category (Cont'd)

Category No.	Category Title	Guideline No.	Guideline
3.16	Equipment Decontamination	MC-07	Maximize areas of constant web thickness in firewalls, carry-through bulkheads, major frames, structural ribs, spars, webs, keels, and close-outs to provide flexibility in locating penetration fittings. Stepped chem milling, stepped machining, stepped composite layup concepts all tend to result in minimal available surface area for penetrations.
		MC-08	All in-line plumbing connections within a fuel tank or cell should be capable of making/breaking the interface by hand, require no torque, contain integral safety locking mechanisms, and should be void of any requirement for safety wire.
		MC-09	All plumbing connections and fittings used for fuel systems should contain integral bonding features to eliminate the need for bonding clamps or jumper cables.
		MC-13	In instances where plumbing or connector interfaces cannot or are not keyed for a specific orientation, all identification, markings, cautions, and directions should be placed 360 degrees around the tube or duct.
		MC-14	Where multiple connectors are located in close proximity, ensure (1) a minimum hand tool arc of 120 degrees can be maintained, and (2) stagger fittings to ensure firm coupling interface/hand tool interface can be accomplished without inducing damage to adjacent lines.
		PYRO-16	Do not use cartridge actuated devices (CADs) for store or weapon ejection or for pylon jettison due to inherent ground safety hazards, stray energy hazards, and scheduled cleaning requirements.
		PYRO-34	Weapon bay door seals should be bonded or attached to door structure to minimize induced seal damage during weapon or store loading.
		WBAY-03	The method and position of the pylon-to-wing gap seal should not form a drip edge for leakage into the pylon cavity.
		WBAY-04	The gap treatment should be a permanent installation on the pylon, wing, or both, not a separate seal.
		WBAY-07	Gap seal should not degrade interchangeability of pylon.
		WBAY-08	Gap seal and treatment should be fully compatible with steam from carrier catapults.
		WBAY-09	Gap seal/pylon should not cover or hamper access to low point wing drains.
		WBAY-11	Gap seal should match pylon and wing/fuselage surface impedance.
		WBAY-12	Pylon-to-store/weapon gap seal should permit visual and physical access during loading for all interfaces between bomb rack-to-store, bomb rack-to-launcher, and launcher-to-store.
		WBAY-13	Pylon-to-store/weapon gap seal should not interfere with automatic sway brace function.
		WBAY-14	Pylon-to-store/weapon gap seal should permit physical access to lanyards.
		WBAY-15	Gap seals should not hinder pilot or ground crew preflight inspection.
		WBAY-16	Gap seals should not degrade loading while wearing arctic or chemical, biological, or radiation protective clothing.
		WBAY-17	Special coatings or conductive paints on pylons, launchers, racks, launchers, tanks, pods, etc. should have the durability to withstand contact with support stands/cradles during storage.
WBAY-18	The proximity of the gun firing barrel to structure should be such that structural furrows or channels are not required for projectile clearances during firing.		
WBAY-20	Gun plugs required solely to maintain a given signature level should be capable of on-board stowage for use only when a threat requires their presence.		
WBAY-21	Coatings and finishes in the area of gun barrels should be durable to withstand the effect of exiting projectile shockwaves.		
WBAY-22	The proximity of the gun blast deflector to structure should not require reliance on high-temperature paints or coatings to protect the structure.		
3.17	Survival Equipment	WIND-06	Do not locate windows in the proximity of rooster tails created by wheels/tires passing through water or slush.
		A-13	Two-sided or two-surfaced access should not be required for access to equipment interfaces and hardpoints. The term two-sided infers top/bottom, left/right, front/back, or combinations thereof.
		A-18	Use transparent windows, quick-opening covers, or openings without any cover to permit quick visual inspections where needed.
		BIT-01	During design of the BIT, use worst-case stress analysis to ensure that any circuit failures induced by temperature extremes, tolerance build-up, power supply variations, and combinations thereof are identified.

Guidelines by Category (Cont'd)

Category No.	Category Title	Guideline No.	Guideline
3.17	Survival Equipment		
		BIT-02	Ensure that BIT system thresholds are consistent with those across the system, subsystem, item, module, and piece-part levels to prevent excessive numbers of Cannot Duplicate (CND) and Retest OK (RTOK) events from occurring.
		BIT-03	The degree of BIT required or proposed should be based on the respective failure rates and the appropriate FMECA at all equipment indenture levels.
		BIT-04	Limit the amount of data that is recorded to a manageable size by: <ul style="list-style-type: none"> - Limiting the number of signals that are monitored - Limiting the maximum sampling rate - Reducing the time span over which data is accumulated - Restricting the type of data accumulated
		BIT-05	Incorporate testability design features as an integral part of equipment preliminary design process.
		BIT-06	Mission critical functions should be monitored by BIT.
		BIT-09	Use concurrent BIT to monitor system critical functions.
		BIT-20	The BIT should be mechanized so that when a piece of equipment is not installed in a subsystem or the product, a failure will not be indicated.
		CARGO-01	Ground vehicles with storage bays or compartments accessible from outside the vehicle should: <ul style="list-style-type: none"> - Have the door sill located no lower than knee height to accommodate a wide range of percentiles while standing. - Ensure door handles are flush with outer surface to protect personnel. - Contain goose neck hinges to protect the hinge from the elements. - Contain peripheral door seals that will protect against blowing sand entry at 50 mph. - Ensure door can be opened with transport tie downs installed. - Ensure door opening envelope does not intrude into the opening envelope of an adjacent door. - Contain simple sheet metal hold-open spring or mechanism. - Ensure floor of bay or compartment is flush with sill to simplify cleanout and drainage. - Ensure door unlocking and opening mechanism can be actuated by a 95 percentile male hand while wearing arctic gloves. - Contain 15 percent added volume for density growth.
		CARGO-02	Ground vehicles with small exterior storage bays or compartments containing emergency equipment or supplies should: <ul style="list-style-type: none"> - Be located at chest height of the 50 percentile male. - Contain unlatching mechanisms activated by pushing inward on the door. - Meet all other generic bay and compartment requirements.
		CREW-02	Armor protection integrated with the vehicle structure should be given preference over parasitic armor.
		CREW-03	In rare cases where armor is parasitic, armor should be interchangeable and easily installed.
		D&V-01	The geometric aspects of structural design and interfaces should not result in any natural bathtubs.
		D&V-02	Closed structural sections subject to condensation or fluid migration should contain drainage provisions.
		D&V-03	Crew cabs, operators' compartments, crew stations, cockpits, and passenger compartments should be subject to the same corrosion prevention measures as the exteriors of the vehicles. Low points, pockets, and related fluid collection points within should be provided with low point drains.
		MC-01	All clamps should contain torque-set or torque-limiting connections to prevent clamp or component failure due to over-torque. Clamp installation call outs should not depend on special tools to establish the required torque values.
		MC-02	Avoid the use of cotter pins, safety wire, safety clips, and similar devices to prevent maintenance-induced events leading to ground vehicle accidents or loss of air vehicles.
		MC-03	All tubing connections and interfaces should use rosan/dynatube (or equivalent) to (1) enable connect or disconnect with one hand, one tool, (2) eliminate the need to safety the connection, (3) provide a superior seal, and (4) negate need to reposition line(s) during component replacement.
		MC-04	No trombone type, flared tube type, or piloted line type interfaces should be used to avoid the need for removal or repositioning during equipment removal.
		MC-05	Avoid potential foreign object traps during manufacturing or operational maintenance by eliminating vertical penetrations of plumbing/fittings into tanks, compartments, or cells

Guidelines by Category (Cont'd)

Category No.	Category Title	Guideline No.	Guideline
3.17	Survival Equipment		
		MC-06	Locate, position, orient all plumbing and duct electrical connectors to prevent the need for sequential installation or removal.
		MC-09	All plumbing connections and fittings used for fuel systems should contain integral bonding features to eliminate the need for bonding clamps or jumper cables.
		MC-11	No subsystem plumbing, equipment, or wiring should use a tank, cell, or compartment containing liquids as a means for routing or penetration simplicity during manufacture.
		MC-12	All plumbing and connectors containing liquids should be meniscus-free.
		MC-13	In instances where plumbing or connector interfaces cannot or are not keyed for a specific orientation, all identification, markings, cautions, and directions should be placed 360 degrees around the tube or duct.
		MC-14	Where multiple connectors are located in close proximity, ensure (1) a minimum hand tool arc of 120 degrees can be maintained, and (2) stagger fittings to ensure firm coupling interface/hand tool interface can be accomplished without inducing damage to adjacent lines.
		MP-01	Avoid the use of epoxies to mount parts on repairable modules because they make repair extremely difficult.
		MP-02	Use a unique identification (ID) resistor incorporated in each system module to verify that the proper module is mounted on ATE.
		MP-03	Design modules so that lengthy warm-up times, special coding and air purity levels, and similar constraints are not necessary.
		P-03	All doors and panels subject to environmental elements should contain form-in-place seals (or equivalent) attached to the door structure, not substructure, to prevent damage during maintenance.
		P-04	Door and panel seals should be compatible with all types of on-board servicing fluids, de-ice and anti-ice fluids, and all fluids used for chemical, biological, and nuclear decontamination.
		P-05	Piano type hinges should not be used on doors or panels because they are subject to wear, corrosion, and sand and fluid entry.
		PERS-01	Group man-machine interfaces manifold-style to enable connect/disconnect in a single action.
		PERS-02	Include an integral, highly visible indicator in a man-machine interface connector to denote connector is seated and locked.
		PERS-03	Design interface connectors so that a distinct action is required by an individual to effect a disconnect. (Excludes airframe-to-ejection seat personnel interfaces.)
		PERS-04	Interfaces should contain an emergency release mechanism that can be activated by rescue personnel with a 95 percentile gloved hand.
		PERS-05	Design emergency interface release mechanisms to be clearly visible under all types of lighting situations.
		PERS-06	Storage bins, compartments, sacks, or bags should be available within the vehicle to store/protect all personal equipment required to conduct operations.
		PERS-07	All flight and ground vehicles should contain one cubic foot minimum storage compartment(s) for various loose and sundry personal items (for each individual).
		PERS-08	Design stowage and mounting provisions for portable air or oxygen containers to withstand 40G crash or impact loads.
		SAFE-03	Stored energy devices (e.g., accumulators, nitrogen bottles, gas generators, etc.), that could cause injury, harm, or damage if inadvertently actuated, should contain integral safing provisions.
		SEAT-01	Design personnel seats and padding materials, including the covers and fillers, so they are incapable of creating or emitting toxic fumes or dense smoke when subjected to fire.
		SI-03	Parts and assemblies of a given model product or of models of a product in the same series should be interchangeable or replaceable.
		SURV-01	Design containers used for dinghy stowage to be structurally capable of containing the dinghy within the event of unintentional or uncommanded inflation.
		SURV-02	Provide crew stations, crew compartments, and operator areas containing dinghies as emergency equipment with a suitable tool for puncturing or cutting the dinghy in the event of inadvertent inflation. Locate the tool so that access is assured during dinghy inflation.

Guidelines by Category (Cont'd)

Category No.	Category Title	Guideline No.	Guideline
3.17	Survival Equipment		
		SURV-03	Survival gear containerization or storage should have a minimum twelve-month period between scheduled tests, checks, or replacements.
		SURV-04	Do not seal battery power or battery-operated devices in survival packages or containers. When this guideline cannot be followed, provide a remote way of ascertaining the status or condition of the battery.
		SURV-05	Design survival equipment pods intended for external carriage or suspension to meet the same environmental and operational criteria as the host vehicle structure.
		T-05	Design single-shot (one time use) type thrusters with a minimum 6-year shelf life and a 7-year installed life.
3.17.01	Survival Packs	A-18	Use transparent windows, quick-opening covers, or openings without any cover to permit quick visual inspections where needed.
		BIT-05	Incorporate testability design features as an integral part of equipment preliminary design process.
		BIT-06	Mission critical functions should be monitored by BIT.
		BIT-09	Use concurrent BIT to monitor system critical functions.
		BIT-20	The BIT should be mechanized so that when a piece of equipment is not installed in a subsystem or the product, a failure will not be indicated.
		ENV-01	Materials, treatments, coatings, finishes should be compatible with all anti-ice and de-ice fluids, chemical and biological decontamination fluids, washing and cleaning fluids, and all vehicle subsystem fluids.
		MC-01	All clamps should contain torque-set or torque-limiting connections to prevent clamp or component failure due to over-torque. Clamp installation call outs should not depend on special tools to establish the required torque values.
		MC-02	Avoid the use of cotter pins, safety wire, safety clips, and similar devices to prevent maintenance-induced events leading to ground vehicle accidents or loss of air vehicles.
		MC-06	Locate, position, orient all plumbing and duct electrical connectors to prevent the need for sequential installation or removal.
		MC-09	All plumbing connections and fittings used for fuel systems should contain integral bonding features to eliminate the need for bonding clamps or jumper cables.
		MC-11	No subsystem plumbing, equipment, or wiring should use a tank, cell, or compartment containing liquids as a means for routing or penetration simplicity during manufacture.
		MC-12	All plumbing and connectors containing liquids should be meniscus-free.
		MC-14	Where multiple connectors are located in close proximity, ensure (1) a minimum hand tool arc of 120 degrees can be maintained, and (2) stagger fittings to ensure firm coupling interface/hand tool interface can be accomplished without inducing damage to adjacent lines.
		MP-01	Avoid the use of epoxies to mount parts on repairable modules because they make repair extremely difficult.
		MP-02	Use a unique identification (ID) resistor incorporated in each system module to verify that the proper module is mounted on ATE.
		MP-03	Design modules so that lengthy warm-up times, special coding and air purity levels, and similar constraints are not necessary.
		PERS-01	Group man-machine interfaces manifold-style to enable connect/disconnect in a single action.
		PERS-02	Include an integral, highly visible indicator in a man-machine interface connector to denote connector is seated and locked.
		PERS-03	Design interface connectors so that a distinct action is required by an individual to effect a disconnect. (Excludes airframe-to-ejection seat personnel interfaces.)
		PERS-04	Interfaces should contain an emergency release mechanism that can be activated by rescue personnel with a 95 percentile gloved hand.
		PERS-05	Design emergency interface release mechanisms to be clearly visible under all types of lighting situations.
		PERS-06	Storage bins, compartments, sacks, or bags should be available within the vehicle to store/protect all personal equipment required to conduct operations.

MIL-HDBK-470A

APPENDIX C

Guidelines by Category (Cont'd)

Category No.	Category Title	Guideline No.	Guideline
3.17.01	Survival Packs	PERS-07	All flight and ground vehicles should contain one cubic foot minimum storage compartment(s) for various loose and sundry personal items (for each individual).
		PERS-08	Design stowage and mounting provisions for portable air or oxygen containers to withstand 40G crash or impact loads.
		SAFE-03	Stored energy devices (e.g., accumulators, nitrogen bottles, gas generators, etc.), that could cause injury, harm, or damage if inadvertently actuated, should contain integral safing provisions.
		SI-03	Parts and assemblies of a given model product or of models of a product in the same series should be interchangeable or replaceable.
3.17.02	Dinghies, Boats	T-05	Design single-shot (one time use) type thrusters with a minimum 6-year shelf life and a 7-year installed life.
		A-18	Use transparent windows, quick-opening covers, or openings without any cover to permit quick visual inspections where needed.
		BIT-05	Incorporate testability design features as an integral part of equipment preliminary design process.
		BIT-06	Mission critical functions should be monitored by BIT.
		BIT-09	Use concurrent BIT to monitor system critical functions.
		BIT-20	The BIT should be mechanized so that when a piece of equipment is not installed in a subsystem or the product, a failure will not be indicated.
		BIT-26	Locate routinely used test points so they are accessible without removing or disassembling other equipment
		EC-12	Electrical penetrations into a compartment should not be on a vertical axis to ensure foreign matter does not enter connector.
		ENV-06	For ground vehicles, the finishes should be compatible with and durable against all rain, hail, sleet, snow, and ice conditions experienced in all intended operational environments.
		ENV-07	The finishes and surfaces should be capable of low velocity impact (LVI) of 10 foot-pounds with no visual or detectable damage with a design goal of 30 foot-pounds.
		MC-01	All clamps should contain torque-set or torque-limiting connections to prevent clamp or component failure due to over-torque. Clamp installation call outs should not depend on special tools to establish the required torque values.
		MC-02	Avoid the use of cotter pins, safety wire, safety clips, and similar devices to prevent maintenance-induced events leading to ground vehicle accidents or loss of air vehicles.
		MC-03	All tubing connections and interfaces should use rosam/dynatube (or equivalent) to (1) enable connect or disconnect with one hand, one tool, (2) eliminate the need to safety the connection, (3) provide a superior seal, and (4) negate need to reposition line(s) during component replacement.
		MC-04	No trombone type, flared tube type, or piloted line type interfaces should be used to avoid the need for removal or repositioning during equipment removal.
		MC-05	Avoid potential foreign object traps during manufacturing or operational maintenance by eliminating vertical penetrations of plumbing/fittings into tanks, compartments, or cells
		MC-06	Locate, position, orient all plumbing and duct electrical connectors to prevent the need for sequential installation or removal.
		MC-07	Maximize areas of constant web thickness in firewalls, carry-through bulkheads, major frames, structural ribs, spars, webs, keels, and close-outs to provide flexibility in locating penetration fittings. Stepped chem milling, stepped machining, stepped composite layup concepts all tend to result in minimal available surface area for penetrations.
		MC-08	All in-line plumbing connections within a fuel tank or cell should be capable of making/breaking the interface by hand, require no torque, contain integral safety locking mechanisms, and should be void of any requirement for safety wire.
		MC-09	All plumbing connections and fittings used for fuel systems should contain integral bonding features to eliminate the need for bonding clamps or jumper cables.
		MC-11	No subsystem plumbing, equipment, or wiring should use a tank, cell, or compartment containing liquids as a means for routing or penetration simplicity during manufacture.
		MC-12	All plumbing and connectors containing liquids should be meniscus-free.

Guidelines by Category (Cont'd)

Category No.	Category Title	Guideline No.	Guideline
3.17.02	Dinghies, Boats	MC-14	Where multiple connectors are located in close proximity, ensure (1) a minimum hand tool arc of 120 degrees can be maintained, and (2) stagger fittings to ensure firm coupling interface/hand tool interface can be accomplished without inducing damage to adjacent lines.
		MC-15	Route, orient, and position plumbing, wiring, ducts, and connectors sufficiently away from the outer surface of the vehicle to preclude induced damage due to minor dents, drill bits during repair, etc. Minimum rule of thumb is 1" away from the inner surface and 1" below a plate nut channel.
		MP-01	Avoid the use of epoxies to mount parts on repairable modules because they make repair extremely difficult.
		MP-02	Use a unique identification (ID) resistor incorporated in each system module to verify that the proper module is mounted on ATE.
		MP-03	Design modules so that lengthy warm-up times, special coding and air purity levels, and similar constraints are not necessary.
		PERS-01	Group man-machine interfaces manifold-style to enable connect/disconnect in a single action.
		PERS-02	Include an integral, highly visible indicator in a man-machine interface connector to denote connector is seated and locked.
		PERS-03	Design interface connectors so that a distinct action is required by an individual to effect a disconnect. (Excludes airframe-to-ejection seat personnel interfaces.)
		PERS-04	Interfaces should contain an emergency release mechanism that can be activated by rescue personnel with a 95 percentile gloved hand.
		PERS-05	Design emergency interface release mechanisms to be clearly visible under all types of lighting situations.
		PERS-08	Design stowage and mounting provisions for portable air or oxygen containers to withstand 40G crash or impact loads.
		SAFE-03	Stored energy devices (e.g., accumulators, nitrogen bottles, gas generators, etc.), that could cause injury, harm, or damage if inadvertently actuated, should contain integral safing provisions.
		SI-03	Parts and assemblies of a given model product or of models of a product in the same series should be interchangeable or replaceable.
		SURV-01	Design containers used for dinghy stowage to be structurally capable of containing the dinghy within the event of unintentional or uncommanded inflation.
		SURV-02	Provide crew stations, crew compartments, and operator areas containing dinghies as emergency equipment with a suitable tool for puncturing or cutting the dinghy in the event of inadvertent inflation. Locate the tool so that access is assured during dinghy inflation.
3.17.03	Pods and Capsules	T-05	Design single-shot (one time use) type thrusters with a minimum 6-year shelf life and a 7-year installed life.
		A-06	Hardpoints (structural attachment and load bearing areas) within a compartment to assist in equipment mounting or support should not be integral with the machined part. Hardpoints should be parasitic to enable quick repair in case of wear or damage in lieu of precise ream/bush repair typical of machined hardpoints.
		A-08	Plumbing penetrations into a compartment should not be on a vertical axis due to difficulty in making or breaking vertically-oriented connections. When compartment access is from the bottom, vertically-oriented connections can allow fluid to leak onto the maintainer. When access is from the top, such connections can allow foreign matter to enter the line. Use horizontal penetrations whenever possible.
		A-10	Provide a sufficient number of compartment fluid drains to ensure fluid drainage for varying aircraft static attitudes and varying terrain slopes for ground vehicles.
		A-14	Do not locate nutplates or gang channels in inaccessible areas that would require extensive disassembly or equipment removal to gain access.
		A-18	Use transparent windows, quick-opening covers, or openings without any cover to permit quick visual inspections where needed.
		BIT-01	During design of the BIT, use worst-case stress analysis to ensure that any circuit failures induced by temperature extremes, tolerance build-up, power supply variations, and combinations thereof are identified.
		BIT-02	Ensure that BIT system thresholds are consistent with those across the system, subsystem, item, module, and piece-part levels to prevent excessive numbers of Cannot Duplicate (CND) and Retest OK (RTOK) events from occurring.

Guidelines by Category (Cont'd)

Category No.	Category Title	Guideline No.	Guideline
3.17.03	Pods and Capsules	BIT-03	The degree of BIT required or proposed should be based on the respective failure rates and the appropriate FMECA at all equipment indenter levels.
		BIT-04	Limit the amount of data that is recorded to a manageable size by: <ul style="list-style-type: none"> - Limiting the number of signals that are monitored - Limiting the maximum sampling rate - Reducing the time span over which data is accumulated - Restricting the type of data accumulated
		BIT-05	Incorporate testability design features as an integral part of equipment preliminary design process.
		BIT-06	Mission critical functions should be monitored by BIT.
		BIT-09	Use concurrent BIT to monitor system critical functions.
		BIT-16	Critical voltages should be visually monitored by sending the voltage signals to visible LEDs.
		BIT-20	The BIT should be mechanized so that when a piece of equipment is not installed in a subsystem or the product, a failure will not be indicated.
		BIT-26	Locate routinely used test points so they are accessible without removing or disassembling other equipment
		D&V-01	The geometric aspects of structural design and interfaces should not result in any natural bathtubs.
		D&V-02	Closed structural sections subject to condensation or fluid migration should contain drainage provisions.
		D&V-03	Crew cabs, operators' compartments, crew stations, cockpits, and passenger compartments should be subject to the same corrosion prevention measures as the exteriors of the vehicles. Low points, pockets, and related fluid collection points within should be provided with low point drains.
		EC-12	Electrical penetrations into a compartment should not be on a vertical axis to ensure foreign matter does not enter connector.
		ENV-01	Materials, treatments, coatings, finishes should be compatible with all anti-ice and de-ice fluids, chemical and biological decontamination fluids, washing and cleaning fluids, and all vehicle subsystem fluids.
		ENV-06	For ground vehicles, the finishes should be compatible with and durable against all rain, hail, sleet, snow, and ice conditions experienced in all intended operational environments.
		ENV-07	The finishes and surfaces should be capable of low velocity impact (LVI) of 10 foot-pounds with no visual or detectable damage with a design goal of 30 foot-pounds.
		F-01	Use blind fasteners only where absolutely necessary or where considerable cost can be saved.
		F-02	Minimize access fasteners while making them quick release, easily removed and replaced, and captive.
		F-03	Choose fasteners based on the requirement top operate by hand or with common hand tools rather than special tools.
		F-04	Whenever possible, incorporate barrel type fasteners as opposed to hi-torque fasteners. Failure of Hi-torque fasteners due to stripping are common and a source of potential foreign object damage (FOD).
		MC-01	All clamps should contain torque-set or torque-limiting connections to prevent clamp or component failure due to over-torque. Clamp installation call outs should not depend on special tools to establish the required torque values.
		MC-02	Avoid the use of cotter pins, safety wire, safety clips, and similar devices to prevent maintenance-induced events leading to ground vehicle accidents or loss of air vehicles.
		MC-03	All tubing connections and interfaces should use rosam/dynatube (or equivalent) to (1) enable connect or disconnect with one hand, one tool, (2) eliminate the need to safety the connection, (3) provide a superior seal, and (4) negate need to reposition line(s) during component replacement.
		MC-04	No trombone type, flared tube type, or piloted line type interfaces should be used to avoid the need for removal or repositioning during equipment removal.
		MC-05	Avoid potential foreign object traps during manufacturing or operational maintenance by eliminating vertical penetrations of plumbing/fittings into tanks, compartments, or cells
		MC-06	Locate, position, orient all plumbing and duct electrical connectors to prevent the need for sequential installation or removal.

Guidelines by Category (Cont'd)

Category No.	Category Title	Guideline No.	Guideline
3.17.03	Pods and Capsules	MC-07	Maximize areas of constant web thickness in firewalls, carry-through bulkheads, major frames, structural ribs, spars, webs, keels, and close-outs to provide flexibility in locating penetration fittings. Stepped chem milling, stepped machining, stepped composite layup concepts all tend to result in minimal available surface area for penetrations.
		MC-08	All in-line plumbing connections within a fuel tank or cell should be capable of making/breaking the interface by hand, require no torque, contain integral safety locking mechanisms, and should be void of any requirement for safety wire.
		MC-09	All plumbing connections and fittings used for fuel systems should contain integral bonding features to eliminate the need for bonding clamps or jumper cables.
		MC-11	No subsystem plumbing, equipment, or wiring should use a tank, cell, or compartment containing liquids as a means for routing or penetration simplicity during manufacture.
		MC-12	All plumbing and connectors containing liquids should be meniscus-free.
		MC-14	Where multiple connectors are located in close proximity, ensure (1) a minimum hand tool arc of 120 degrees can be maintained, and (2) stagger fittings to ensure firm coupling interface/hand tool interface can be accomplished without inducing damage to adjacent lines.
		MC-15	Route, orient, and position plumbing, wiring, ducts, and connectors sufficiently away from the outer surface of the vehicle to preclude induced damage due to minor dents, drill bits during repair, etc. Minimum rule of thumb is 1" away from the inner surface and 1" below a plate nut channel.
		MP-01	Avoid the use of epoxies to mount parts on repairable modules because they make repair extremely difficult.
		MP-02	Use a unique identification (ID) resistor incorporated in each system module to verify that the proper module is mounted on ATE.
		MP-03	Design modules so that lengthy warm-up times, special coding and air purity levels, and similar constraints are not necessary.
		P-01	Access door and panel fastener types for airborne vehicles should meet the following criteria: <ul style="list-style-type: none"> - use latches for a frequency of access of 0 to 40 flight hours - use High Strength Quick Release fasteners for a frequency of access of 40-400 flight hours - use structural screws for a frequency of access of 400 flight hours or more
		P-02	Access door and panel fastener types for surface vehicles should meet the following criteria: <ul style="list-style-type: none"> - use a spring loaded or latch fastener for an opening frequency of daily - use a one quarter turn fastener (or equivalent) for an opening frequency of weekly - use screws or bolts for all other cases
		P-03	All doors and panels subject to environmental elements should contain form-in-place seals (or equivalent) attached to the door structure, not substructure, to prevent damage during maintenance.
		P-04	Door and panel seals should be compatible with all types of on-board servicing fluids, de-ice and anti-ice fluids, and all fluids used for chemical, biological, and nuclear decontamination.
		P-05	Piano type hinges should not be used on doors or panels because they are subject to wear, corrosion, and sand and fluid entry.
		PERS-01	Group man-machine interfaces manifold-style to enable connect/disconnect in a single action.
		PERS-02	Include an integral, highly visible indicator in a man-machine interface connector to denote connector is seated and locked.
		PERS-03	Design interface connectors so that a distinct action is required by an individual to effect a disconnect. (Excludes airframe-to-ejection seat personnel interfaces.)
		PERS-04	Interfaces should contain an emergency release mechanism that can be activated by rescue personnel with a 95 percentile gloved hand.
		PERS-05	Design emergency interface release mechanisms to be clearly visible under all types of lighting situations.
		PERS-06	Storage bins, compartments, sacks, or bags should be available within the vehicle to store/protect all personal equipment required to conduct operations.
		PERS-07	All flight and ground vehicles should contain one cubic foot minimum storage compartment(s) for various loose and sundry personal items (for each individual).

Guidelines by Category (Cont'd)

Category No.	Category Title	Guideline No.	Guideline
3.17.03	Pods and Capsules	PERS-08	Design stowage and mounting provisions for portable air or oxygen containers to withstand 40G crash or impact loads.
		SABCH-11	In rare instances where the use of dissimilar material in immediate contact cannot be avoided, they should be sufficiently insulated to endure for the life of the vehicle.
		SABCH-12	Avoid tapping threads into structural members. Use of heli-coil type or similar insert concepts is permissible.
		SABCH-13	No structural design concept should rely on frequent scheduled inspections to monitor or otherwise ensure structural integrity.
		SABCH-14	No structural fastener intended to carry shear or tension loads should be smaller than 1/4" diameter (.25").
		SABCH-15	Give preference to butt type splices over lap type splices in the design of manufacturing splices.
		SAFE-03	Stored energy devices (e.g., accumulators, nitrogen bottles, gas generators, etc.), that could cause injury, harm, or damage if inadvertently actuated, should contain integral safing provisions.
		SI-03	Parts and assemblies of a given model product or of models of a product in the same series should be interchangeable or replaceable.
		T-05	Design single-shot (one time use) type thrusters with a minimum 6-year shelf life and a 7-year installed life.
		WIND-06	Do not locate windows in the proximity of rooster tails created by wheels/tires passing through water or slush.
3.17.04	Backpacks	WIND-07	Use materials that are highly resistive to thermal shock.
		MC-02	Avoid the use of cotter pins, safety wire, safety clips, and similar devices to prevent maintenance-induced events leading to ground vehicle accidents or loss of air vehicles.
		MC-06	Locate, position, orient all plumbing and duct electrical connectors to prevent the need for sequential installation or removal.
		PERS-01	Group man-machine interfaces manifold-style to enable connect/disconnect in a single action.
		PERS-02	Include an integral, highly visible indicator in a man-machine interface connector to denote connector is seated and locked.
		PERS-03	Design interface connectors so that a distinct action is required by an individual to effect a disconnect. (Excludes airframe-to-ejection seat personnel interfaces.)
		PERS-04	Interfaces should contain an emergency release mechanism that can be activated by rescue personnel with a 95 percentile gloved hand.
		PERS-05	Design emergency interface release mechanisms to be clearly visible under all types of lighting situations.
		PERS-08	Design stowage and mounting provisions for portable air or oxygen containers to withstand 40G crash or impact loads.
		SI-03	Parts and assemblies of a given model product or of models of a product in the same series should be interchangeable or replaceable.
3.18	Tools	EC3-24	System design and integration and technology application should be such that requirements for torque is not required.
		ENG(G)-01	Provide access to all engine mounts for ground vehicles so that hoisting or crawling under the vehicle is not required.
		ENG(G)-04	Do not use downward engine removal concepts that require jacking or hoisting of the ground vehicle.
		FUEL-05	Intersecting of two or more surfaces in a fuel wetted area of less than 90 degrees should be avoided to simplify manufacture and repair.
		FUEL-06	Where maintaining a minimum angle of 90 degrees is not possible, sufficient depth, width, and height should be maintained to provide tool clearances for all tools used in the manufacturing processes and in the operational field repair environment.
		LG-13	No special tools or equipment should be required to maintain/service struts in normal day-to-day operational environments.
		LG-17	Hydraulic, pneumatic, or electrical actuators associated with landing gear systems should not require adjustment or rigging once installed in the air vehicle. Spare units should be rigged at the time of manufacture or overhaul.
		PYRO-46	Design pylons, launchers, and ejector racks so that weapon loading, servicing, and reconfigurations can be accomplished using standard hand tools.
		PYRO-47	Installation design of ejectors, launchers, racks, and associated hardware interfaces should avoid reliance on torque wrenches.

Guidelines by Category (Cont'd)

Category No.	Category Title	Guideline No.	Guideline
3.18	Tools	SURV-02	Provide crew stations, crew compartments, and operator areas containing dinghies as emergency equipment with a suitable tool for puncturing or cutting the dinghy in the event of inadvertent inflation. Locate the tool so that access is assured during dinghy inflation.
3.18.01	Standard and Special	OXY-10	Effective leak detection sensors should be integral to the system.
3.19	Miscellaneous	A-07	Paint equipment bay and compartment interiors a high gloss white to maximize lighting reflectivity, visibility, and rapid leak detection capability.
		A-11	Locate compartment electrical penetrations close to the access opening for ease of sight, probing, repair, and to eliminate fluid soaking, wicking, or contamination.
		A-12	Locate compartment electrical penetrations far enough from the access opening to prevent damage resulting from improper (over-length) panel fasteners.
		A-13	Two-sided or two-surfaced access should not be required for access to equipment interfaces and hardpoints. The term two-sided infers top/bottom, left/right, front/back, or combinations thereof.
		A-14	Do not locate nuplates or gang channels in inaccessible areas that would require extensive disassembly or equipment removal to gain access.
		A-18	Use transparent windows, quick-opening covers, or openings without any cover to permit quick visual inspections where needed.
		MC-06	Locate, position, orient all plumbing and duct electrical connectors to prevent the need for sequential installation or removal.
		SE-05	The geometric aspects of simple maintenance stands, ladders, and work platforms should enable high density stacking for storage and mobility deployments.
3.19.01	Extinguishing Agents, Containers, Controls, and Devices	A-08	Plumbing penetrations into a compartment should not be on a vertical axis due to difficulty in making or breaking vertically-oriented connections. When compartment access is from the bottom, vertically-oriented connections can allow fluid to leak onto the maintainer. When access is from the top, such connections can allow foreign matter to enter the line. Use horizontal penetrations whenever possible.
		A-09	Any heat or temperature sensitive structure within a compartment should contain heat-sensitive tape or appropriate heat sensor for easy indication of over-temperature excursions.
		BIT-01	During design of the BIT, use worst-case stress analysis to ensure that any circuit failures induced by temperature extremes, tolerance build-up, power supply variations, and combinations thereof are identified.
		BIT-02	Ensure that BIT system thresholds are consistent with those across the system, subsystem, item, module, and piece-part levels to prevent excessive numbers of Cannot Duplicate (CND) and Retest OK (RTOK) events from occurring.
		BIT-03	The degree of BIT required or proposed should be based on the respective failure rates and the appropriate FMECA at all equipment indenture levels.
		BIT-04	Limit the amount of data that is recorded to a manageable size by: <ul style="list-style-type: none"> - Limiting the number of signals that are monitored - Limiting the maximum sampling rate - Reducing the time span over which data is accumulated - Restricting the type of data accumulated
		BIT-05	Incorporate testability design features as an integral part of equipment preliminary design process.
		BIT-06	Mission critical functions should be monitored by BIT.
		BIT-09	Use concurrent BIT to monitor system critical functions.
		BIT-16	Critical voltages should be visually monitored by sending the voltage signals to visible LEDs.
		BIT-20	The BIT should be mechanized so that when a piece of equipment is not installed in a subsystem or the product, a failure will not be indicated.
		BIT-26	Locate routinely used test points so they are accessible without removing or disassembling other equipment
		CONT-01	Control rods should use Boyd or impedance type bolts (or equivalent) to eliminate the need for cotter pins or safety wire.
		CONT-02	Do not use metal control cables for vehicles that will operate in salt water or salt air environments.
		CONT-03	Use control rods rather than control cables for non-complex applications and non-complex routing within the vehicle.

Guidelines by Category (Cont'd)

Category No.	Category Title	Guideline No.	Guideline
3.19.01	Extinguishing Agents, Containers, Controls, and Devices	CONT-04	Use control cables rather than control rods for most complex applications.
		CONT-05	Route cables so that 100 percent of a cable will be viewable for inspection.
		CONT-06	Design all pulleys and brackets associated with cable installations so they are accessible by a 75 percentile male hand.
		ENG-26	Locate and position engine overheat and fire warning sensors so that damage cannot occur during engine maintenance or replacement.
		EXTING-01	Use extinguishing concepts dedicated to each individual fire zone in preference to manifold systems operating from a central source.
		EXTING-02	Design sealed extinguishing agent containers with an integral pressure/volume gage and a pressure-sensing transmitter for remote read-out.
		EXTING-03	Keep each individual fire zone over-temperature/fire warning system separate from those in other fire zones.
		EXTING-04	Design individual fire zone over-temperature/fire warning system to be fully BIT capable (the BIT concept should permit both initiated and periodic BIT).
		EXTING-05	Route and locate all tube, wire, and plumbing interfaces in a manner that prevents induced damage during maintenance.
		EXTING-06	Provide an alternate capability to activate the system remotely from the cockpit/crew station, or operator's position to satisfy emergency situations during vehicle maintenance.
		EXTING-07	Analyze the vehicle operational environment and type of fire zones to determine if remote stop/shut-off of equipment is warranted.
		EXTING-08	Analyze the vehicle operational environment and type of fire zones to determine if remote alarm and/or visual indication of a fire is warranted.
		EXTING-09	Do not locate provisions for overboard venting or dumping of extinguishing agents in areas that could create hazards for personnel.
		MC-01	All clamps should contain torque-set or torque-limiting connections to prevent clamp or component failure due to over-torque. Clamp installation call outs should not depend on special tools to establish the required torque values.
		MC-02	Avoid the use of cotter pins, safety wire, safety clips, and similar devices to prevent maintenance-induced events leading to ground vehicle accidents or loss of air vehicles.
		MC-03	All tubing connections and interfaces should use rosan/dynatube (or equivalent) to (1) enable connect or disconnect with one hand, one tool, (2) eliminate the need to safety the connection, (3) provide a superior seal, and (4) negate need to reposition line(s) during component replacement.
		MC-04	No trombone type, flared tube type, or piloted line type interfaces should be used to avoid the need for removal or repositioning during equipment removal.
		MC-05	Avoid potential foreign object traps during manufacturing or operational maintenance by eliminating vertical penetrations of plumbing/fittings into tanks, compartments, or cells.
		MC-06	Locate, position, orient all plumbing and duct electrical connectors to prevent the need for sequential installation or removal.
		MC-09	All plumbing connections and fittings used for fuel systems should contain integral bonding features to eliminate the need for bonding clamps or jumper cables.
		MC-10	In rare instances where a plumbing run contains complex form or geometry that would require removal of other plumbing or equipment for access, in-line connectors should be incorporated to maintain the integrity of other plumbing or equipment.
		MC-11	No subsystem plumbing, equipment, or wiring should use a tank, cell, or compartment containing liquids as a means for routing or penetration simplicity during manufacture.
		MC-12	All plumbing and connectors containing liquids should be meniscus-free.
		MC-13	In instances where plumbing or connector interfaces cannot or are not keyed for a specific orientation, all identification, markings, cautions, and directions should be placed 360 degrees around the tube or duct.

Guidelines by Category (Cont'd)

Category No.	Category Title	Guideline No.	Guideline
3.19.01	Extinguishing Agents, Containers, Controls, and Devices	MC-14	Where multiple connectors are located in close proximity, ensure (1) a minimum hand tool are of 120 degrees can be maintained, and (2) stagger fittings to ensure firm coupling interface/hand tool interface can be accomplished without inducing damage to adjacent lines.
		MP-01	Avoid the use epoxies to mount parts on repairable modules because they make repair extremely difficult.
		MP-02	Use a unique identification (ID) resistor incorporated in each system module to verify that the proper module is mounted on ATE.
		MP-03	Design modules so that lengthy warm-up times, special coding and air purity levels, and similar constraints are not necessary.
		SAFE-06	Wing fold locking mechanisms should provide a moldline indication that locks are in place. Loose or separate safety devices that must be installed manually should be avoided.
		SAFE-07	Landing and alighting gear design should ensure downlocks are integral to the mechanisms and provide a clear indication of position status. This guideline also applies to tail hooks.
		SAFE-08	A single lever safety should, when positioned, safe the entire escape/ejection system. Use of the single lever to "arm" should require two hands.
		SAFE-09	Safing the canopy jettison system should be accomplished through the same lever device used to safe the ejection seat.
		SAFE-10	The single lever safing concept should apply to day-to-day flight operations. Individual or multiple safety pins for pyrotechnic devices should only be required during escape system maintenance.
		SEAT-01	Design personnel seats and padding materials, including the covers and fillers, so they are incapable of creating or emitting toxic fumes or dense smoke when subjected to fire.
		SI-03	Parts and assemblies of a given model product or of models of a product in the same series should be interchangeable or replaceable.
3.19.02	Safe/Arm Devices - Non Weapon	BIT-01	During design of the BIT, use worst-case stress analysis to ensure that any circuit failures induced by temperature extremes, tolerance build-up, power supply variations, and combinations thereof are identified.
		BIT-02	Ensure that BIT system thresholds are consistent with those across the system, subsystem, item, module, and piece-part levels to prevent excessive numbers of Cannot Duplicate (CND) and Retest OK (RTOK) events from occurring.
		BIT-03	The degree of BIT required or proposed should be based on the respective failure rates and the appropriate FMECA at all equipment indenture levels.
		BIT-04	Limit the amount of data that is recorded to a manageable size by: <ul style="list-style-type: none"> - Limiting the number of signals that are monitored - Limiting the maximum sampling rate - Reducing the time span over which data is accumulated - Restricting the type of data accumulated
		BIT-05	Incorporate testability design features as an integral part of equipment preliminary design process.
		BIT-06	Mission critical functions should be monitored by BIT.
		BIT-09	Use concurrent BIT to monitor system critical functions.
		BIT-16	Critical voltages should be visually monitored by sending the voltage signals to visible LEDs.
		BIT-20	The BIT should be mechanized so that when a piece of equipment is not installed in a subsystem or the product, a failure will not be indicated.
		BIT-26	Locate routinely used test points so they are accessible without removing or disassembling other equipment
		CONT-01	Control rods should use Boyd or impedance type bolts (or equivalent) to eliminate the need for cotter pins or safety wire.
		CONT-02	Do not use metal control cables for vehicles that will operate in salt water or salt air environments.
		CONT-03	Use control rods rather than control cables for non-complex applications and non-complex routing within the vehicle.
		CONT-04	Use control cables rather than control rods for most complex applications.
		CONT-05	Route cables so that 100 percent of a cable will be viewable for inspection.
		CONT-06	Design all pulleys and brackets associated with cable installations so they are accessible by a 75 percentile male hand.
		LG-01	Bearings, excluding wheel bearings, should not require lubrication during the expected life of the air vehicle airframe.

Guidelines by Category (Cont'd)

Category No.	Category Title	Guideline No.	Guideline
3.19.02	Safe/Arm Devices - Non Weapon	LG-04	Do not use Beryllium and Beryllium base alloys in any location subject to wear or corrosive atmospheres or in installations where machining may be required.
		LG-05	All bolts or similar threaded means used as adjustable stops should be positively retained in the adjusted reference without reliance on jam nuts, cotter pins, or safety wire.
		MC-02	Avoid the use of cotter pins, safety wire, safety clips, and similar devices to prevent maintenance-induced events leading to ground vehicle accidents or loss of air vehicles.
		MC-11	No subsystem plumbing, equipment, or wiring should use a tank, cell, or compartment containing liquids as a means for routing or penetration simplicity during manufacture.
		MC-12	All plumbing and connectors containing liquids should be meniscus-free.
		MC-13	In instances where plumbing or connector interfaces cannot or are not keyed for a specific orientation, all identification, markings, cautions, and directions should be placed 360 degrees around the tube or duct.
		MC-14	Where multiple connectors are located in close proximity, ensure (1) a minimum hand tool arc of 120 degrees can be maintained, and (2) stagger fittings to ensure firm coupling interface/hand tool interface can be accomplished without inducing damage to adjacent lines.
		MP-01	Avoid the use of epoxies to mount parts on repairable modules because they make repair extremely difficult.
		MP-02	Use a unique identification (ID) resistor incorporated in each system module to verify that the proper module is mounted on ATE.
		MP-03	Design modules so that lengthy warm-up times, special coding and air purity levels, and similar constraints are not necessary.
		PYRO-11	Design electrical/electronic "safe/arm" systems to eliminate the need for mechanical type system interrupt devices.
		SAFE-01	Drag chute installation designs not containing electrical safing should contain remote safe/arm provisions reachable from ground level by 5 percentile females. Remove location should be clear of engine exhaust areas and flight control deflection envelopes.
		SAFE-02	Emergency ingress actuation provisions into cockpits, crew stations, passenger compartments, and operator stations should be accessible from the ground by 5 percentile females.
		SAFE-03	Stored energy devices (e.g., accumulators, nitrogen bottles, gas generators, etc.), that could cause injury, harm, or damage if inadvertently actuated, should contain integral safing provisions.
		SAFE-04	Electrical and optical safe/arm system design should eliminate the need for mechanical type system interrupt devices.
		SAFE-05	Crash locator beacon door opening/ejection mechanisms should contain integral electrical safe/arm features.
		SAFE-11	All individual safety pins used for ground maintenance should be clearly visible and coupled together to ensure no single pin will be overlooked during arming.
		SAFE-12	Internal weapon bay doors should contain integral safety locking features for use during maintenance and weapon loading and downloading.
		SAFE-13	It should not be possible to unsafe a weapon bay door integral lock when a door closed signal is present.
		SI-03	Parts and assemblies of a given model product or of models of a product in the same series should be interchangeable or replaceable.
3.19.03	Anti-ice, De-fog, De-ice, and Windshield Cleaning Systems	A-08	Plumbing penetrations into a compartment should not be on a vertical axis due to difficulty in making or breaking vertically-oriented connections. When compartment access is from the bottom, vertically-oriented connections can allow fluid to leak onto the maintainer. When access is from the top, such connections can allow foreign matter to enter the line. Use horizontal penetrations whenever possible.
		BIT-01	During design of the BIT, use worst-case stress analysis to ensure that any circuit failures induced by temperature extremes, tolerance build-up, power supply variations, and combinations thereof are identified.
		BIT-02	Ensure that BIT system thresholds are consistent with those across the system, subsystem, item, module, and piece-part levels to prevent excessive numbers of Cannot Duplicate (CND) and Retest OK (RTOK) events from occurring.
		BIT-03	The degree of BIT required or proposed should be based on the respective failure rates and the appropriate FMECA at all equipment indenture levels.

Guidelines by Category (Cont'd)

Category No.	Category Title	Guideline No.	Guideline
3.19.03	Anti-ice, De-fog, De-ice, and Windshield Cleaning Systems	BIT-04	Limit the amount of data that is recorded to a manageable size by: <ul style="list-style-type: none"> - Limiting the number of signals that are monitored - Limiting the maximum sampling rate - Reducing the time span over which data is accumulated - Restricting the type of data accumulated
		BIT-05	Incorporate testability design features as an integral part of equipment preliminary design process.
		BIT-06	Mission critical functions should be monitored by BIT.
		BIT-09	Use concurrent BIT to monitor system critical functions.
		BIT-16	Critical voltages should be visually monitored by sending the voltage signals to visible LEDs.
		BIT-20	The BIT should be mechanized so that when a piece of equipment is not installed in a subsystem or the product, a failure will not be indicated.
		BIT-26	Locate routinely used test points so they are accessible without removing or disassembling other equipment
		D&V-01	The geometric aspects of structural design and interfaces should not result in any natural bathtubs.
		D&V-02	Closed structural sections subject to condensation or fluid migration should contain drainage provisions.
		D&V-03	Crew cabs, operators' compartments, crew stations, cockpits, and passenger compartments should be subject to the same corrosion prevention measures as the exteriors of the vehicles. Low points, pockets, and related fluid collection points within should be provided with low point drains.
		ENV-01	Materials, treatments, coatings, finishes should be compatible with all anti-ice and de-ice fluids, chemical and biological decontamination fluids, washing and cleaning fluids, and all vehicle subsystem fluids.
		ENV-02	There should be no top coat or treatment deterioration throughout the standard temperature and humidity spectrum.
		ENV-03	For airborne vehicles, the finishes should be durable against rain, hail, and dynamic erosion throughout the flight envelope.
		ENV-04	For airborne and ground vehicles, the finishes should be durable against sand erosion throughout all surface wind speeds experienced in arid or desert geographical locations.
		IN-06	Front frame anti-ice and de-ice provisions should give preference to engine hot bleed air.
		LO-06	Size flush mounted LO screens for auxiliary air inlets and exits to ensure functionality with up to 25 percent of the openings plugged.
		LO-07	Flush and non-flush LO screens should be interchangeable.
		MC-01	All clamps should contain torque-set or torque-limiting connections to prevent clamp or component failure due to over-torque. Clamp installation call outs should not depend on special tools to establish the required torque values.
		MC-02	Avoid the use of cotter pins, safety wire, safety clips, and similar devices to prevent maintenance-induced events leading to ground vehicle accidents or loss of air vehicles.
		MC-05	Avoid potential foreign object traps during manufacturing or operational maintenance by eliminating vertical penetrations of plumbing/fittings into tanks, compartments, or cells
		MC-06	Locate, position, orient all plumbing and duct electrical connectors to prevent the need for sequential installation or removal.
		MC-10	In rare instances where a plumbing run contains complex form or geometry that would require removal of other plumbing or equipment for access, in-line connectors should be incorporated to maintain the integrity of other plumbing or equipment.
		MC-11	No subsystem plumbing, equipment, or wiring should use a tank, cell, or compartment containing liquids as a means for routing or penetration simplicity during manufacture.
		MC-12	All plumbing and connectors containing liquids should be meniscus-free.
		MC-13	In instances where plumbing or connector interfaces cannot or are not keyed for a specific orientation, all identification, markings, cautions, and directions should be placed 360 degrees around the tube or duct.

MIL-HDBK-470A

APPENDIX C

Guidelines by Category (Cont'd)

Category No.	Category Title	Guideline No.	Guideline
3.19.03	Anti-ice, De-fog, De-ice, and Windshield Cleaning Systems	MC-14	Where multiple connectors are located in close proximity, ensure (1) a minimum hand tool arc of 120 degrees can be maintained, and (2) stagger fittings to ensure firm coupling interface/hand tool interface can be accomplished without inducing damage to adjacent lines.
		MP-01	Avoid the use epoxies to mount parts on repairable modules because they make repair extremely difficult.
		MP-02	Use a unique identification (ID) resistor incorporated in each system module to verify that the proper module is mounted on ATE.
		MP-03	Design modules so that lengthy warm-up times, special coding and air purity levels, and similar constraints are not necessary.
		P-01	Access door and panel fastener types for airborne vehicles should meet the following criteria: <ul style="list-style-type: none"> - use latches for a frequency of access of 0 to 40 flight hours - use High Strength Quick Release fasteners for a frequency of access of 40-400 flight hours - use structural screws for a frequency of access of 400 flight hours or more
		P-02	Access door and panel fastener types for surface vehicles should meet the following criteria: <ul style="list-style-type: none"> - use a spring loaded or latch fastener for an opening frequency of daily - use a one quarter turn fastener (or equivalent) for a opening frequency of weekly - use screws or bolts for all other cases
		P-03	All doors and panels subject to environmental elements should contain form-in-place seals (or equivalent) attached to the door structure, not substructure, to prevent damage during maintenance.
		P-04	Door and panel seals should be compatible with all types of on-board servicing fluids, de-ice and anti-ice fluids, and all fluids used for chemical, biological, and nuclear decontamination.
		P-05	Piano type hinges should not be used on doors or panels because they are subject to wear, corrosion, and sand and fluid entry.
		P-06	Access door and panel devices used to support door in opened position should meet the following criteria: <ul style="list-style-type: none"> - for airborne vehicles, design for 60 knot gust loads (or equivalent jet blast loads) - for ground vehicles, design for 50 mph gust loads
		P-07	Hinged access doors and panels capable of remaining in the opened position should not have sharp edges or corners.
		P-08	Removable access door and panel fasteners should be of identical grip length and diameter.
		P-09	Acceptable door and panel hold-open devices include over-center sheet metal spring, over-center spring link, spring cartridge, support strut, and pinned goose neck hinge.
		P-10	Access doors and panels requiring non-captive fasteners should not be located forward of air inlet ducts or high-energy rotating components (e.g., prop fans, engine cooling fans, etc.).
		P-11	Access doors and panels should be interchangeable as justified by operation and support costs or life cycle costs.
		SI-03	Parts and assemblies of a given model product or of models of a product in the same series should be interchangeable or replaceable.
		WIND-06	Do not locate windows in the proximity of rooster tails created by wheels/tires passing through water or slush.
		CBR-01	Orient all vehicle liquid servicing fittings to ensure fluids will not come in contact with protective garb during connect/disconnect activities.
		CBR-02	Ensure vehicle overboard passive liquid drains are clearly marked or visible to enable personnel to remain clear of area.
		CBR-03	Design fuel cell drains so they can not be activated in a manner that would allow fuel to come in contact with a protected hand.
		CBR-04	Design emergency ingress provisions so they can be activated by a 95 percentile male wearing full protective chemical or biological protection gear.
		CBR-05	Size rescue doors, panels, and "cut here" areas to accommodate the 95 percentile shoulder width wearing full protective chemical or biological protection gear.
		CBR-06	Consider the reduction in peripheral vision resulting from wearing chemical or biological protection gear when designing intended fire paths and crash rescue paths into a vehicle.
3.19.04	Chemical, Biological, and Nuclear Environments and Protection		

Guidelines by Category (Cont'd)

Category No.	Category Title	Guideline No.	Guideline
3.19.04	Chemical, Biological, and Nuclear Environments and Protection	CREW-06	Film magazines, tapes, and removable modules should permit considerable handling without reliance on special support equipment protection.
		CREW-08	Data storage media containers and modules should be capable of chemical and biological decontamination processes.
		EDECOM-01	Provide surface sensors on equipment located in compartments containing louvers, screens, flush inlets, or similar openings to the environment to indicate the presence of chem/bio contaminants.
		EDECOM-02	Provide integral sensors (viewable from the exterior) for equipment subject to internal forced-air cooling from outside or external air to indicate the presence of contaminants.
		EDECOM-03	Design equipment surfaces and structure to be compatible with all decontamination agents and methods.
		EDECOM-04	Provide passive overboard drains in compartments subject to decontamination processes to void the area of contaminants.
		EDECOM-05	Provide hoist, lift or transport handles for equipment requiring removal from the host vehicle for decontamination. In instances where this may not be practical, design the equipment with hardpoints for attaching parasitic carrying provisions
		ENG-06	All other engine surfaces and engine-mounted accessory surfaces should be free of pockets, channels, and bathtubs that could trap and retain fluids.
		ENG-47	Design the engine, including all accessories, plumbing, wiring, ducts, and mechanisms, to meet the same environmental protection and compatibility requirements as the host vehicle.
		ENV-01	Materials, treatments, coatings, finishes should be compatible with all anti-ice and de-ice fluids, chemical and biological decontamination fluids, washing and cleaning fluids, and all vehicle subsystem fluids.
		ENV-02	There should be no top coat or treatment deterioration throughout the standard temperature and humidity spectrum.
		ENV-03	For airborne vehicles, the finishes should be durable against rain, hail, and dynamic erosion throughout the flight envelope.
		ENV-04	For airborne and ground vehicles, the finishes should be durable against sand erosion throughout all surface wind speeds experienced in arid or desert geographical locations.
		ENV-06	For ground vehicles, the finishes should be compatible with and durable against all rain, hail, sleet, snow, and ice conditions experienced in all intended operational environments.
		ENV-07	The finishes and surfaces should be capable of low velocity impact (LVI) of 10 foot-pounds with no visual or detectable damage with a design goal of 30 foot-pounds.
		FUEL-01	Locate fuel vent and dump masts to ensure exiting fuel will be clear of servicing, loading, arming and safing areas for all types of ground and airborne vehicles.
		IN(V)-08	Incorporate an inlet closure door sealing concept that prevents entry of fluid, dust, or sand across the entire airborne and ground environment spectrum.
		LO-01	Use LO compatible gap fillers for manufactured gaps in lieu of tape and butter (surface coating compound).
		LO-02	Avoid scheduled forced inspections or replacement of materials, coatings, or finishes solely to protect either the reliability or the signature.
		MC-01	All clamps should contain torque-set or torque-limiting connections to prevent clamp or component failure due to over-torque. Clamp installation call outs should not depend on special tools to establish the required torque values.
		MC-02	Avoid the use of cotter pins, safety wire, safety clips, and similar devices to prevent maintenance-induced events leading to ground vehicle accidents or loss of air vehicles.
		MC-03	All tubing connections and interfaces should use rosam/dynatube (or equivalent) to (1) enable connect or disconnect with one hand, one tool, (2) eliminate the need to safety the connection, (3) provide a superior seal, and (4) negate need to reposition line(s) during component replacement.
		MC-04	No trombone type, flared tube type, or piloted line type interfaces should be used to avoid the need for removal or repositioning during equipment removal.
		MC-06	Locate, position, orient all plumbing and duct electrical connectors to prevent the need for sequential installation or removal.
		P-03	All doors and panels subject to environmental elements should contain form-in-place seals (or equivalent) attached to the door structure, not substructure, to prevent damage during maintenance.

Guidelines by Category (Cont'd)

Category No.	Category Title	Guideline No.	Guideline
3.19.04	Chemical, Biological, and Nuclear Environments and Protection	P-04	Door and panel seals should be compatible with all types of on-board servicing fluids, de-ice and anti-ice fluids, and all fluids used for chemical, biological, and nuclear decontamination.
		P-05	Piano type hinges should not be used on doors or panels because they are subject to wear, corrosion, and sand and fluid entry.
		PERS-01	Group man-machine interfaces manifold-style to enable connect/disconnect in a single action.
		PERS-02	Include an integral, highly visible indicator in a man-machine interface connector to denote connector is seated and locked.
		PERS-03	Design interface connectors so that a distinct action is required by an individual to effect a disconnect. (Excludes airframe-to-ejection seat personnel interfaces.)
		PERS-04	Interfaces should contain an emergency release mechanism that can be activated by rescue personnel with a 95 percentile gloved hand.
		PERS-05	Design emergency interface release mechanisms to be clearly visible under all types of lighting situations.
		PERS-06	Storage bins, compartments, sacks, or bags should be available within the vehicle to store/protect all personal equipment required to conduct operations.
		PERS-07	All flight and ground vehicles should contain one cubic foot minimum storage compartment(s) for various loose and sundry personal items (for each individual).
		SIMP-01	Location and design of all exterior lights should not require protective covers in ground environments.
		SIMP-02	Landing and taxi lights should be mounted on landing gear struts or doors to eliminate separate compartments, doors, and retraction/extension mechanisms.
		WBAY-03	The method and position of the pylon-to-wing gap scale should not form a drip edge for leakage into the pylon cavity.
		WBAY-04	The gap treatment should be a permanent installation on the pylon, wing, or both, not a separate seal.
		WBAY-07	Gap seal should not degrade interchangeability of pylon.
		WBAY-08	Gap seal and treatment should be fully compatible with steam from carrier catapults.
		WBAY-09	Gap seal/pylon should not cover or hamper access to low point wing drains.
		WBAY-11	Gap seal should match pylon and wing/fuselage surface impedance.
		WBAY-12	Pylon-to-store/weapon gap seal should permit visual and physical access during loading for all interfaces between bomb rack-to-store, bomb rack-to-launcher, and launcher-to-store.
		WBAY-13	Pylon-to-store/weapon gap seal should not interfere with automatic sway brace function.
		WBAY-14	Pylon-to-store/weapon gap seal should permit physical access to lanyards.
		WBAY-15	Gap seals should not hinder pilot or ground crew preflight inspection.
		WBAY-16	Gap seals should not degrade loading while wearing arctic or chemical, biological, or radiation protective clothing.
		WBAY-17	Special coatings or conductive paints on pylons, launchers, racks, launchers, tanks, pods, etc. should have the durability to withstand contact with support stands/cradles during storage.
		WBAY-18	The proximity of the gun firing barrel to structure should be such that structural furrows or channels are not required for projectile clearances during firing.

MIL-HDBK-470A

CONCLUDING MATERIAL

CUSTODIANS:

ARMY - SY
NAVY - AS
AIR FORCE - 17
DLA - DH

PREPARING ACTIVITY:

AF-17
(PROJECT MNTY-0016)

REVIEW ACTIVITIES:

ARMY - IE, MI, PT, TM2
NAVY - AS, CG, EC, MC, NP, SA, TD
AIR FORCE - 08, 10, 13, 19, 21, 33
DLA - DH
DIA - DI
NSA - NS
NORAD - US
OSD - HS, MA

STANDARDIZATION DOCUMENT IMPROVEMENT PROPOSAL

INSTRUCTIONS

1. The preparing activity must complete blocks 1, 2, 3, and 8. In block 1, both the document number and revision letter should be given.
2. The submitter of this form must complete blocks 4, 5, 6, and 7.
3. The preparing activity must provide a reply within 30 days from receipt of the form.

NOTE: This form may not be used to request copies of documents, nor to request waivers, or clarification of requirements on current contracts. Comments submitted on this form do not constitute or imply authorization to waive any portion of the referenced document(s) or to amend contractual requirements.

I RECOMMEND A CHANGE:

1. DOCUMENT NUMBER

MIL-HDBK-407A

2. DOCUMENT DATE (YYMMDD)

97/08/04

3. DOCUMENT TITLE DESIGNING AND DEVELOPING MAINTAINABLE PRODUCTS AND SYSTEMS

4. NATURE OF CHANGE *Identify paragraph number and include proposed rewrite, if possible. Attach extra sheets as needed.)*

5. REASON FOR RECOMMENDATION

6. SUBMITTER

a. NAME *(Last, First, Middle Initial)*

b. ORGANIZATION

c. ADDRESS *(Include Zip Code)*

d. TELEPHONE *(Include Area Code)*
 (1) Commercial
 (2) AUTOVON
(if applicable)

7. DATE SUBMITTED
 (YYMMDD)

8. PREPARING ACTIVITY

a. NAME

ROME LABORATORY/ERSR

b. TELEPHONE *Include Area Code)*

(1) Commercial (315) 330-4205
 (2) AUTOVON 587-4205

c. ADDRESS *(Include Zip Code)*

525 BROOKS RD.
 ROME, NY 13441-4505

IF YOU DO NOT RECEIVE A REPLY WITHIN 45 DAYS, CONTACT:

DEFENSE QUALITY AND STANDARDIZATION OFFICE
 5203 Leesburg Pike, Suite 1403, Falls Church, VA 22401-3466
 Telephone (703) 756-2340 AUTOVON 289-2340